

T8501D Deluxe Zone Thermostat

INSTALLATION INSTRUCTIONS

APPLICATION

The T8501 Deluxe Zone Thermostat provides electronic control of 24 Vac single-stage zoned heating and cooling systems. Refer to Table 1 for a general description of the thermostat.

Table 1. Description of T8501 Thermostat.

Model	Application	Powering Method	Changeover	System Selection	Fan Selection
T8501D	Zone 1 on MABS II or TotalZone® system	Requires common wire to power supply	Automatic or Manual	Heat-Off-Cool-Auto	On-Auto



RECYCLING NOTICE

If this control is replacing a control that contains mercury in a sealed tube, do *not* place your old control in the trash.

Contact your local waste management authority for instructions regarding recycling and the proper disposal of the old thermostat.

Do not install the thermostat where it can be affected by:

- drafts, or dead spots behind doors and in corners.
- hot or cold air from ducts.
- radiant heat from sun or appliances.
- concealed pipes and chimneys.
- unheated (uncooled) areas such as an outside wall behind the thermostat.

Wallplate Installation

The thermostat can be mounted horizontally on the wall or on a 2 in. x 4 in. wiring box. Position wallplate horizontally on the wall or on a 2 in. x 4 in. wiring box.

INSTALLATION

When Installing this Product...

1. Read these instructions carefully. Failure to follow the instructions can damage the product or cause a hazardous condition.
2. Check the ratings given in the instructions and on the product to make sure the product is suitable for your application.
3. Installer must be a trained, experienced service technician.
4. After completing installation, use these instructions to check out the product operation.

1. Position and level the wallplate (for appearance only). The thermostat will function properly even when not level.
2. Use a pencil to mark the mounting holes. See Fig. 2.
3. Remove the wallplate from the wall and drill two 3/16 inch holes in the wall (if drywall) as marked. For firmer material such as plaster, drill two 7/32 inch holes. Gently tap anchors (provided) into the drilled holes until flush with the wall.
4. Position the wallplate over the holes, pulling wires through the wiring opening.
5. Loosely insert the mounting screws into the holes.
6. Tighten mounting screws.

Location

Install the thermostat about 5 ft (1.5m) above the floor in an area with good air circulation at average temperature. See Fig. 1.



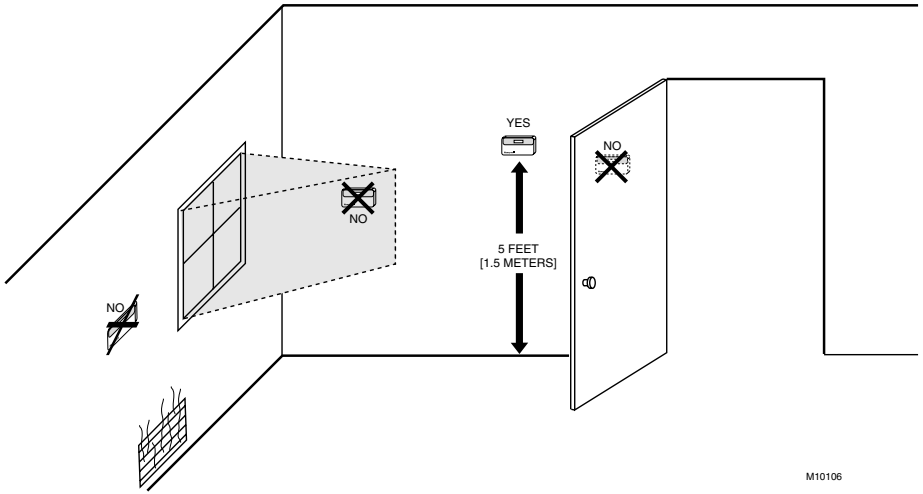

M10106

Fig. 1. Typical location of thermostat.

Wiring

All wiring must comply with local electrical codes and ordinances. Refer to Fig. 3 and 4 for typical hookups. A letter code is located near each terminal for identification.



CAUTION

Disconnect power before wiring to prevent electrical shock or equipment damage.

1. Loosen the terminal screws on the wallplate and connect the system wires. See Fig. 5.

IMPORTANT

Use 18 gauge, color-coded thermostat cable for proper wiring.

2. Securely tighten each terminal screw.
3. Push excess wire back into the hole.
4. Plug the hole with nonflammable insulation to prevent drafts from affecting the thermostat.

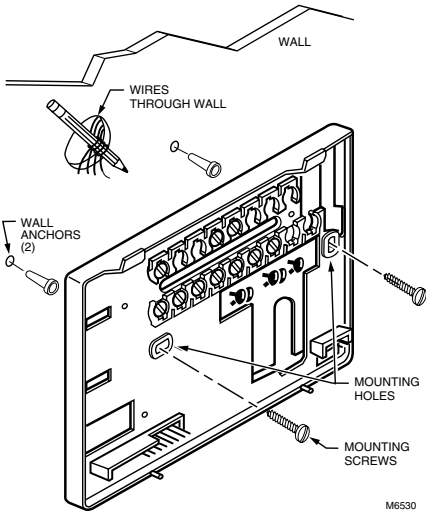

M6530

Fig. 2. Mounting the wallplate.

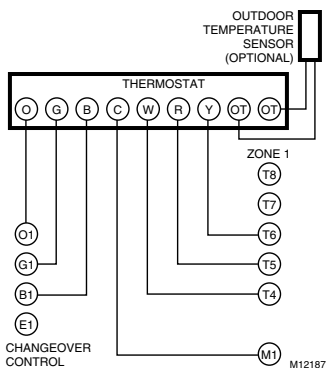

Fig. 3. Typical wiring diagram for T8501D with zone 1 MABS II control panel.

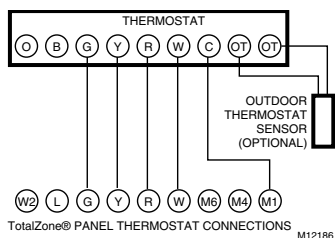

Fig. 4. Typical wiring diagram for T8501D with zone 1 TotalZone® control panel.

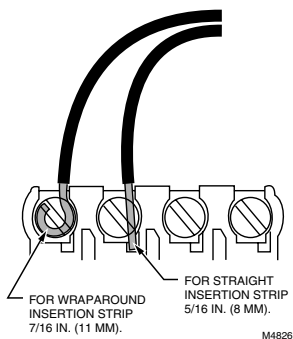

Fig. 5. Proper wiring technique.

Mounting Thermostat

1. Engage tabs at the top of the thermostat and wallplate. See Fig. 6.
2. Press lower edge of case to close and latch.

NOTE: To remove the thermostat from the wall, first pull out at the bottom of the thermostat; remove top last.

A. ENGAGE TABS AT TOP OF THERMOSTAT AND WALLPLATE.

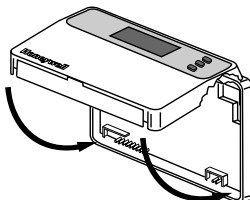

B. PRESS LOWER EDGE OF CASE TO LATCH.

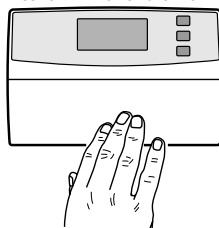

Fig. 6. Mounting thermostat on wallplate.

Using Thermostat Keys

The thermostat keys are used to:

- set temperature,
- display present setting,
- configure Installer Setup,
- check System-Test,
- display outdoor temperature (select models),
- set the system operation,
- set the fan operation.

See Fig. 7 for the location of the keys.

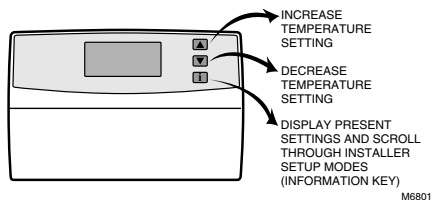

Fig. 7. Key locations and descriptions.

SETTINGS

System and Fan Settings

System settings control the thermostat operation as follows:

- Heat: The thermostat controls the heating.
- Off: Both the heating and cooling are off.
- Cool: The thermostat controls the cooling.
- Auto: The thermostat automatically changes between heating and cooling operation, depending on the indoor temperature.

Fan settings control the system fan as follows:

- On: Fan operates continuously.
- Auto: Fan operates with equipment.

The system default setting is Heat and the fan default setting is Auto. Use the keyboard to change to the desired settings. See Fig. 8.

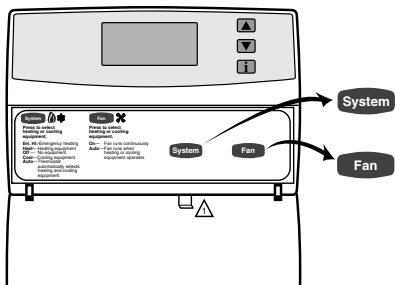

▲ CHECK LIGHT ON SELECT MODELS

M10147

Fig. 8. Thermostat System and Fan key location.

NOTE: Always press the keys with your fingertip or similar blunt tool. Sharp instruments like a pen or pencil point can damage the keyboard.

Temperature Settings

The default setpoint for heat is 70°F (21°C) and for cool is 78°F (25.5°C). Press the increase ▲ or decrease ▼ key to change the present setting to change between heat and cool, press the Information **i** key until the setting to be changed appears. Press the increase ▲ or decrease ▼ key to adjust the setting.

INSTALLER SETUP

NOTE: For most applications, the thermostat factory-settings will not need to be changed. Review the factory settings in Table 2 and if no changes are necessary, go to the Installer System-Test section.

The Installer Setup is used to customize the thermostat to specific systems. Some of the options include temperature display, changeover and outdoor temperature display. Installer Setup numbers are listed in Table 2. The table includes all the configuration options and the factory settings for the T8501.

A combination of key presses are required to use the Installer Setup feature.

- To enter the Installer Setup, press and hold the Information **i** key with the increase ▲ and decrease ▼ keys until the first number is displayed. All display segments appear for approximately three seconds before the number is displayed. See Fig. 9 and 10.
- To advance to the next Installer Setup, press the Information **i** key.
- To change a setting, use the increase ▲ and decrease ▼ keys.
- To exit the Installer Setup, press and hold the Information **i** key until the display returns to normal (approximately three seconds). The display will scroll the numbers backwards to get to the normal display. The Installer Setup is automatically exited if no key presses are made for ten minutes.

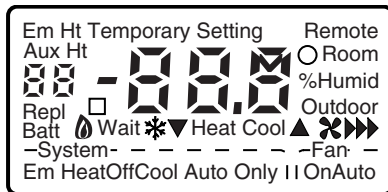

M4644

Fig. 9. Display of all the segments of the LCD.

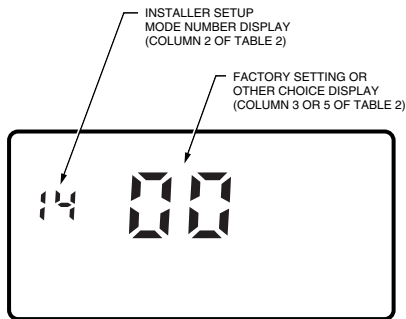

M10105A

Fig. 10. Display of Installer Setup number and setting.

IMPORTANT

Only configurable numbers are shown on the device. Example: If thermostat does not have outdoor temperature capability, Installer Setup Number 24 will not be displayed. Review Table 2 factory-settings and mark any desired changes in the Actual Settings column. When Installer Setup is complete, review the settings to confirm that they match the system.

Table 2. Thermostat Installer Setup Options.

Select	Installer Setup Number (Press i key to change)	Factory Setting		Other Choices (Press ▲ or ▼ key to change)		Actual Setting
		Display	Description	Display	Description	
Not used	01	—	—	—	—	—
Fan operation ^a	02	00	Conventional applications where equipment controls fan operation in heat mode	01	Heat pump and electric heat applications where thermostat controls fan operation in heat mode	—
Not used	03	—	—	—	—	—
Heating cycle rate	04	06	6 cph used for conventional systems	01, 03, or 09	01—1 cph used for radiant floor heat, gravity systems 03—3 cph used for hot water systems or high efficiency furnaces 09—9 cph used for electric heat systems	—
Not used	05 thru 11	—	—	—	—	—
Changeover	12	01	Manual changeover	00 or 02	00—Manual changeover 02—Auto only	—
Not used	13	—	—	—	—	—
Degree temperature display	14	00	Temperature is displayed in °F	01	Temperature is displayed in °C	—
Not used	15 thru 18	—	—	—	—	—
Extended fan operation in heating ^{a,b}	19	00	No extended fan operation after the call for heat ends	01	Fan operation is extended 90 seconds after the call for heat ends	—
Extended fan operation in cooling ^{a,b}	20	00	No extended fan operation after the call for cool ends	01	Fan operation is extended 90 seconds after the call for cool ends	—
Not used	21 thru 23	—	—	—	—	—
Outdoor temperature display ^b	24	00	No outdoor temperature is displayed	01	Outdoor temperature is displayed. Needs a C7089B1000 Outdoor Sensor to operate.	—
Not used	25 thru 32	—	—	—	—	—
Minimum off time for the compressor	33	05	5 minute minimum off time for the compressor	00, 01, 02, 03 or 04	Minimum number of minutes (0 thru 5) the compressor will be off between calls for the compressor	—
Heating setpoint range stop ^b	34	90	Heating setpoint can be set no higher than 90°F	40 thru 90	Number can be set anywhere between 40 and 90 in 1°F increments	—
Cooling setpoint range stop ^b	35	48	Cooling setpoint can be set no lower than 48°F	48 thru 99	Number can be set anywhere between 48 and 99 in 1°F increments	—
System on indicator (flame=heat, snowflake=cool) is displayed ^b	36	00	LCD On symbol is displayed when system is energized	01	Display is disabled	—
Temperature display adjustment	37	00	No difference in displayed temperature and actual room temperature	-3 thru 03	01—Display adjusts to 1°F higher than actual room temperature 02—Display adjusts to 2°F higher than actual room temperature 03—Display adjusts to 3°F higher than actual room temperature -1—Display adjusts to 1°F lower than actual room temperature -2—Display adjusts to 2°F lower than actual room temperature -3—Display adjusts to 3°F lower than actual room temperature	—

^a Number 02 must be set to 01 to extend fan operation.

^b Available on select models.

IMPORTANT

Review the settings to confirm that they match the system. To exit the Installer Setup, press and hold the Information **i** key until the display returns to normal (approximately three seconds).

INSTALLER SYSTEM-TEST

Use the Installer System-Test to check the thermostat operation. Refer to Table 3 for a list of the available system-tests.

To start the system-test:

CAUTION

The minimum off time for compressors is bypassed during the Installer System-Test. Equipment damage can occur if the compressor is cycled too quickly.

Press and hold the increase **▲** and decrease **▼** keys at the same time, until two zeros appear. All segments of the LCD will be displayed before the two zeros appear. See Fig. 11 and 12.

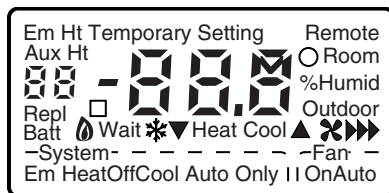

M4844

Fig. 11. Display of all the segments of the LCD.



M6792

Fig. 12. Display of test number.

Table 3. Tests Available In The Installer System-Test.

Test Number	Self-Test Description
10-19	Heating equipment can be turned on and off
30-39	Cooling equipment can be turned on and off
40-49	Fan equipment can be turned on and off
60-69	Keyboard keys test
70-79	Thermostat information including date code and software versions are displayed

Refer to Table 4 for the directions and results of the specific tests.

NOTE: Press and hold the increase **▲** and decrease **▼** keys together for three seconds to exit the system-test. The system-test will time out after ten minutes without any key presses.

Table 4. Installer System-Test Options.

Key to Press	Test Number	Description
Heating Equipment System-Test		
i	10	Enter heating equipment system-test.
▲	11	Heat comes on. When Installer Setup number 02 is 01, the system fan is also energized.
▼	10	Heat and system fan turn off.
Cooling Equipment System-Test		
i	30	Change from heating to cooling equipment system-test.
▲	31	Cool and system fan come on.
▼	30	Cool and system fan turn off.
Fan Equipment System-Test		
i	40	Change from cooling to fan equipment system-test.
▲	41	Fan comes on.
▼	40	Fan turns off.

(Continued)

Table 4. Installer Self-Test Options (Continued).

Key to Press	Test Number	Description
Key Operation System-Test		
IMPORTANT		
<i>Test numbers will only be displayed when the system is configured for the selected function. EXAMPLE: Numbers 60, 61 and 62 are the only numbers that will be displayed when a system is configured for heat only.</i>		
System Key System-Test		
	60	Change from cooling or fan to key operation system-test.
System	61	Heat Test Number is displayed.
System	62	Off Test Number is displayed.
System	63	Cool Test Number is displayed.
System	64	Auto Test Number is displayed.
Fan Key System-Test		
Fan	68	Fan on Test Number is displayed.
Fan	69	Fan off Test Number is displayed.

NOTE: Press and hold the increase ▲ and decrease ▼ keys together for three seconds to exit the system-test. The system-test will time out after ten minutes without any key presses.

THERMOSTAT INFORMATION

1. Press the Information  key to access the thermostat information.



M4864

2. Press the increase ▲ key to display the production date code. The first two large digits are the month and the third digit is the last digit of the year (Example: 027=February 1997).



M10444

3. Press the increase ▲ key again to display the software identification code.



M4866

4. Press the increase ▲ key again to display the software revision number (Example: 001=Revision number 1).



M6791

- Press the increase ▲ key again to display the EEPROM identification code.



M4867

- Press and hold the increase ▲ and decrease ▼ keys together, until the room temperature is displayed, to exit the system-test. The system-test times out after ten minutes without any key presses.

CHECKOUT

Outdoor Temperature Sensor (Where Applicable)

Allow the outdoor temperature sensor to soak in the outdoor air for a minimum of five minutes before taking a reading. With an accurate thermometer ($\pm 1^\circ\text{F}$ [$\pm 0.5^\circ\text{C}$]), measure the temperature at the sensor location, allowing time for the thermometer to stabilize before reading. Match the thermometer reading to the outdoor temperature display at the thermostat.

TROUBLESHOOTING GUIDE

Symptom	Possible Cause	Action
Display will not come on.	Thermostat is not being powered.	<ul style="list-style-type: none"> Check that C terminal is connected to the system transformer. Check for 24 Vac between C and R terminals. <ul style="list-style-type: none"> If missing 24 Vac: <ul style="list-style-type: none"> check if the circuit breaker is tripped—reset the circuit breaker. check if the system fuse is blown—replace the fuse. check if the power switch on the HVAC equipment is in the Off position—set to the On position. check wiring between thermostat and HVAC equipment—replace any broken wires and tighten any loose connections. If 24 Vac is present, proceed with troubleshooting.
	Thermostat microprocessor is locked up.	Remove the thermostat from the wallplate for 2 minutes. After 2 minutes, replace the thermostat on the wallplate.
Temperature display is incorrect.	Room temperature display has been reconfigured.	Enter Installer Setup number 37 and reconfigure the display.
	Thermostat is configured for °F or °C display. ^a	Enter Installer Setup number 14 and reconfigure the display.
	Bad thermostat location.	Relocate the thermostat.
Temperature settings will not change. (Example: Cannot set the heating higher or the cooling lower.)	The upper or lower temperature limits were reached.	Check the temperature setpoints: <ul style="list-style-type: none"> Heating limits are 40 to 90°F (4.5 to 32°C) Cooling limits are 48 to 99°F (7 to 35°C).
	The setpoint temperature range stops were configured.	Check Installer Setup numbers 34 and 35 and reconfigure the setpoint stops.

^a Available on select models.

(Continued)

Troubleshooting Guide (Continued).

Symptom	Possible Cause	Action
Heating will not come on.	No power to the thermostat.	<ul style="list-style-type: none"> • Check that C terminal is connected to the system transformer. • Check for 24 Vac between C and R and between R and W terminals. <ul style="list-style-type: none"> — If missing 24 Vac: <ul style="list-style-type: none"> — check if the circuit breaker is tripped—reset the circuit breaker. — check if the system fuse is blown—replace the fuse. — check if the system switch at the equipment is in the Off position—set to On position. — check wiring between thermostat and HVAC equipment—replace any broken wires and tighten any loose connections. — If 24 Vac is present, proceed with troubleshooting.
	Thermostat minimum off time is activated.	Wait up to five minutes for the system to respond.
	System selection is not set to Heat.	Set system selection to Heat.
Cooling will not come on.	No power to the thermostat.	<ul style="list-style-type: none"> • Check that C terminal is connected to the system transformer. • Check for 24 Vac between C and R and between R and Y terminals. <ul style="list-style-type: none"> — If missing 24 Vac: <ul style="list-style-type: none"> — check if the circuit breaker is tripped—reset the circuit breaker. — check if the system fuse is blown—replace the fuse. — check if the system switch at the equipment is in the Off position—set to the On position. — check wiring between thermostat and HVAC equipment—replace any broken wires and tighten any loose connections. — If 24 Vac is present, proceed with troubleshooting.
	Thermostat minimum off time is activated.	<ul style="list-style-type: none"> • Wait up to five minutes for the system to respond. • Enter Installer Setup number 33. Reconfigure minimum off time (if required).
	System selection is not set to Cool.	Set system selection to Cool.
System on indicator (flame=heat, snowflake=cool) is displayed, but no warm or cool air is coming from the registers.	Fan operation set for 00 (conventional heat) when it should be set for 01 (electric heat).	Enter Installer Setup number 02 and reconfigure the fan operation.
	Conventional heating equipment turns on the fan when the furnace has warmed up to a setpoint.	Wait a minute after seeing the On indicator and then check the registers.
	Heating equipment is not operating.	Verify operation of heating equipment in self-test.
System on indicator is not displayed, but heating or cooling system is operating	Option not activated.	Enter Installer Setup number 36 and reconfigure to 00.
Outdoor temperature not displayed ^a	Option not activated.	Enter Installer Setup number 24 and set to 01. Thermostat must have OT terminals and a C7089B1000 installed.
Outdoor temperature display is incorrect ^a	Outdoor sensor is connected incorrectly.	Refer to C7089B1000 installation instructions and check wiring between the thermostat and sensor.
	Wrong sensor.	Replace sensor with C7089B1000 sensor.

^a Available on select models.

Honeywell

Helping You Control Your World®

Honeywell Trol-A-Temp

57 Bushes Lane
Elmwood Park, NJ 07407-3204
(201) 794-8004
(800) 828-8367
Fax: (201) 794-1359

