

BARD WALL-MOUNT™ Single Stage Air Conditioners 1 to 6 Ton Capacity W12A - W72A Unit Models 115V - 460V, Single and Three Phase 60hz

WA Series WALL-MOUNT™

The Bard WA Series Wall-Mount Air Conditioner is an energy efficient self contained system that is designed to offer maximum indoor temperature control. Installed on an exterior wall surface, the WA Series provides cooling and heating without using valuable indoor floor space or outside ground space. This unit is the ideal product for versatile applications such as: modular buildings, light commercial, mobile buildings, schools, mining, petro-chemical, telecom, industrial, energy storage, and data centers. Factory or field installed accessories are available to meet specific job requirements for your unique application.

WA Series Features:

- 1 to 6 ton cooling capacity uses energy efficient components including today's newest compressor designs.
- Multi-speed Electronically commutated indoor motor (ECM) technology.
- Enclosed outdoor fan motor with ball bearing construction.
- Copper/Aluminum finned coils, and refrigerant system includes filter drier. Evaporator coil includes green fin coil protection.
- R-454B A2L Refrigerant that meets the global objectives outlined in the Montreal Protocol and the Kigali Amendment.
- Factory or field installed ventilation options including economizers and energy recovery ventilators.
- Multiple cabinet finishes including stainless steel and aluminum.
- Coil and cabinet coating options for additional corrosion protection.
- Optional factory or field installed electric heater options from 2kw up to 15kw.
- Optional Circuit breakers for 208/230V single and three phase units.
- Filter options up to MERV13.
- Indoor air quality options including UVC-LED and NPBI devices.
- Controls include short cycle protection and phase monitoring. Hi and low pressure switch refrigerant system protection standard.
- Optional hot gas reheat dehumidification is available for most models.



WA Series Compliance:

- Complies with efficiency requirements of ANSI/ASHRAE/IES 90.1-2019.
- Certified to ANSI/AHRI Standard 390-2021 for SPVU (Single Package Vertical Units).
- Intertek ETL Listed to Standard for Safety of Household and Similar Electrical Appliances ANSI/UL STD 60335-1 & ANSI/UL STD 60335-2-40/CSA STD C22.2 No. 60335-1 & CSA STD C22.2 No. 60335-2-40 Fourth Edition.
- Commercial Product - Not intended for residential applications.
- Bard is an ISO 9001:2015 Certified Manufacturer.
- The AHRI Certified® mark indicates Bard Manufacturing Company participation in the AHRI Certification program. For verification of individual certified products, go to www.ahridirectory.org.



///// WALL-MOUNT W12A (1 TON) TO W72A (6 TON) NOMENCLATURE

MODEL #	W	36	A	F	-	A	OZ	X	P	X	X	X	J
DIGIT #	1	2,3	4	5	6	7	8,9	10	11	12	13	14	15

1	1. Series - Single Stage Compressor
W	Bard Exterior Wall-Mount

2,3	2-3. Nominal Capacity		
12	1.0 Ton	42	3.5 Ton
18	1.5 Ton	48	4.0 Ton
24	2.0 Ton	60	5.0 Ton
30	2.5 Ton	72	6.0 Ton
36	3.0 Ton		

4	4. Unit Type - Controls Location	Units
A	AC-Right or Center Controls	W12-W72
L	AC-Left Side Controls	W18-W36

5	5. Revision
F	Revision (R-454B Refrigerant)

6	6. Special Feature Placeholder	Units
-	Standard Unit	W12-W72
D	HGR Dehumidification	W30-W72
R	Indoor Motor Isolation	W36-W72

7	7. Voltage	Ph.	Hz.	Units
A	208/230VAC	1	60	W12-W72
B	208/230VAC	3	60	W24-W72
C	460VAC	3	60	W24-W72
K	115VAC	1	60	W12 Only
Q	575VAC	3	60	W48-W72

8,9	8-9. Electric Heater Options
00	OKw with Lug Connections
OZ	OKw with Breaker or Disconnect
02-15	2-15Kw Heat w/breaker or Disconnect

10	10. Ventilation Package Options	Units
X	Barometric Air Damper (Intake)	W12-W72
A	Bar. Air Damper (Intake+Exh)	W18-W72
B	Block Off Plate (No Vent)	W12-W72
M	Powered Comm. Vent, On/Off	W18-W72
V	Powered Comm. Vent, On/Off/Mod.	W12-W72
D	Econ, Field Supplied Controls	W18-W72
Y	Full Flow Economizer, JADE, Dry Bulb	W18-W72
Z	Full Flow Economizer, JADE, Enthalpy	W18-W72
R	Energy Recovery Ventilator	W18-W72
E	1-Ton Economizer, JADE, Enthalpy	W12 Only
S	No Hood Economizer, JADE, Enthalpy	W18-W36

11	11. Filter and IAQ Options	Units
X	Standard 1" MERV2 Disposable Filter.	W12-W72
W	1" MERV2 Washable Filter.	W12-W72
P	2" MERV8 Disposable Filter.	W12-W72
M	2" MERV11 Disposable Filter.	W18-W72
N	2" MERV13 Disposable Filter.	W12-W72
A	2" MERV13 Filter with UVC-LED Light.	W18-W72
B	2" MERV13 Filter with NPBI Device.	W18-W72
C	2" MERV8 Filter with NPBI Device.	W18-W72

12	12. Cabinet Color and Finish	Units
X	Standard Beige Enamel Painted Steel.	W12-W72
1	White Enamel Painted Steel.	W12-W72
4	Buckeye Gray Enamel Painted Steel.	W12-W72
5	Desert Brown Enamel Painted Steel.	W12-W72
8	Dark Bronze Enamel Painted Steel.	W12-W72
S	316 Stainless Steel Exterior Finish.	W18-W72
A	Stucco Textured Aluminum Exterior Finish	W18-W72

13	13. Cabinet Style	Units
X	Standard Cabinet	W12-W72
J	Recessed Cabinet Top for Overhangs	W42-W72 (No Dehum)

14	14. Coil and Cabinet Coatings	Units
X	Standard Copper/Aluminum evap and cond coils.	W12-W72
1	Coated indoor evap coil, std outdoor cond. coil.	W12-W72
2	Coated outdoor cond coil, std indoor evap coil.	W12-W72
3	Coated indoor evap and outdoor cond coil.	W18-W72
4	Coated coils and unit cabinet condenser area.	W18-W72
5	Coated coils and interior/exterior cabinet.	W18-W72

15	15. Unit Mounted Controls Options	Units
Standard: Hi/Lo Pressure and Ref. Leak (RDS) Sensor		
X	Standard Controls	W12-W72
E	X + Low Ambient Control (LAC)	W12-W72
J	X + LAC and Alarm Relay (ALR)	W12-W72
F	X + LAC, ALR, and Filter Switch (FS)	W42-W72
K	X + LAC and PTCR Start Kit.	W18-W72
M	X + LAC, ALR, and PTCR Start Kit	W18-W72
V	X + DDC Control Sensor kit	W18-W72

INTERACTIVE TABLE OF CONTENTS (SELECT  ICON WITH CURSOR TO GO TO LOCATION, PICK  TO RETURN)



WA SERIES AHRI CAPACITY AND EFFICIENCY RATINGS

MODELS	W12AF	W18AF W18LF	W24AF W24LF	W30AF W30LF	W36AF W36LF	W42AF	W48AF	W60AF	W72AF
Cooling Capacity BTUH ^①	13,800	17,600	24,000	29,000	36,000	42,500	48,000	56,000	73,000
Unit efficiency EER	11.0	11.0	11.0	11.0	11.0	11.0	11.0	11.0	11.0

① Capacity is certified in accordance with ANSI/ARI Standard 390-2021.

② EER = Energy Efficiency Ratio and is certified in accordance with ANSI/ARI Standard 390-2021. All ratings based on no outside air introduction).

UNIT COOLING CAPACITY AT VARIOUS INDOOR AND OUTDOOR CONDITIONS, W12A TO W42A UNITS

MODEL	INDOOR RETURN AIR (DB/WB)	COOLING CAPACITY (BTUH)	DRY BULB OUTDOOR AIR TEMPERATURE ENTERING UNIT CONDENSER AREA										
			75°F 23.9°C	80°F 26.6°C	85°F 29.4°C	90°F 32.2°C	95°F 35°C	100°F 37.8°C	105°F 40.5°C	110°F 43.3°C	115°F 46.1°C	120°F 48.8°C	125°F 51.6°C
W12AF	75/62	Total Cooling	14900	14200	13500	12800	12100	11500	10700	10100	9300	8700	8000
		Sensible Cooling	10800	10700	10500	10300	10100	10000	9700	9400	9100	8700	8000
	80/67	Total Cooling	15900	15400	14900	14400	13800	13300	12600	12000	11200	10500	9700
		Sensible Cooling	10400	10400	10400	10300	10200	10100	9900	9700	9400	9200	8800
	85/72	Total Cooling	19000	18000	17200	16300	15400	14600	13600	12800	11800	11000	10000
		Sensible Cooling	10700	10600	10500	10300	10000	9800	9500	9100	8700	8400	7800
W18AF	75/62	Total Cooling	18700	17800	17000	16100	15400	14600	13900	13200	12500	11800	11200
		Sensible Cooling	14200	13900	13600	13300	13000	12700	12400	12100	11900	11500	11200
	80/67	Total Cooling	19900	19400	18800	18200	17600	17000	16400	15700	15000	14300	13600
		Sensible Cooling	13700	13600	13400	13300	13100	12900	12700	12500	12300	12000	11800
	85/72	Total Cooling	23700	22700	21600	20600	19600	18600	17700	16700	15800	14900	14000
		Sensible Cooling	14100	13800	13500	13200	12900	12500	12100	11800	11400	10900	10500
W24AF	75/62	Total Cooling	26300	24700	23400	22200	20900	19900	19000	18200	17500	16900	16300
		Sensible Cooling	21100	19800	18700	17800	17100	16500	16000	15800	15600	15600	15800
	80/67	Total Cooling	28000	26900	25900	25000	24000	23200	22400	21700	21000	20400	19800
		Sensible Cooling	20400	19400	18500	17800	17200	16800	16400	16300	16200	16300	16600
	85/72	Total Cooling	33400	31500	29800	28300	26700	25400	24200	23100	22100	21200	20400
		Sensible Cooling	20900	19700	18600	17700	16900	16300	15700	15300	15000	14800	14700
W30AF	75/62	Total Cooling	31500	29800	28100	26700	25300	24100	23000	22100	21200	20400	19700
		Sensible Cooling	24300	23400	22600	22000	21300	20800	20300	19900	19400	19000	18700
	80/67	Total Cooling	33600	32400	31200	30100	29000	28100	27100	26300	25500	24700	24000
		Sensible Cooling	23500	22900	22400	22000	21500	21100	20800	20500	20200	19900	19700
	85/72	Total Cooling	40100	37900	35900	34000	32200	30800	29200	28000	26800	25700	24700
		Sensible Cooling	24100	23300	22500	21900	21100	20400	19900	19200	18600	18000	17500
W36AF	75/62	Total Cooling	38800	36700	34900	33000	31400	29900	28400	27100	25900	24800	23700
		Sensible Cooling	30100	29200	28300	27400	26600	25900	25300	24700	24100	23700	23300
	80/67	Total Cooling	41400	40000	38700	37300	36000	34800	33500	32300	31100	30000	28900
		Sensible Cooling	29200	28600	28000	27400	26800	26300	25900	25500	25100	24800	24500
	85/72	Total Cooling	49300	46800	44500	42100	40000	38100	36100	34400	32700	31200	29700
		Sensible Cooling	29900	29100	28200	27200	26300	25500	24700	23900	23100	22400	21700
W42AF	75/62	Total Cooling	44800	43200	41400	39300	37000	34600	32100	29200	26200	23000	19600
		Sensible Cooling	35000	33600	32400	31400	30400	29600	29000	28400	26200	23000	19600
	80/67	Total Cooling	47800	47100	45900	44400	42500	40300	37800	34800	31500	27900	23900
		Sensible Cooling	33900	32900	32100	31400	30700	30100	29700	29300	29000	27900	23900
	85/72	Total Cooling	57000	55100	52700	50100	47200	44100	40800	37000	33100	29000	24600
		Sensible Cooling	34700	33400	32300	31200	30100	29100	28300	27500	26700	25200	21200



UNIT COOLING CAPACITY AT VARIOUS INDOOR AND OUTDOOR CONDITIONS, W48A TO W72A UNITS

MODEL	INDOOR RETURN AIR (DB/WB)	COOLING CAPACITY (BTUH)	DRY BULB OUTDOOR AIR TEMPERATURE ENTERING UNIT CONDENSER AREA										
			75°F 23.9°C	80°F 26.6°C	85°F 29.4°C	90°F 32.2°C	95°F 35°C	100°F 37.8°C	105°F 40.5°C	110°F 43.3°C	115°F 46.1°C	120°F 48.8°C	125°F 51.6°C
W48AF	75/62	Total Cooling	49900	47800	45800	43700	41800	40000	38200	36600	35000	33300	31900
		Sensible Cooling	39100	38200	37400	36500	35700	34900	34100	33400	32700	32000	31300
	80/67	Total Cooling	53300	52100	50800	49400	48000	46600	45100	43600	42100	40400	38800
		Sensible Cooling	37900	37400	37000	36500	36000	35500	35000	34500	34000	33500	32900
	85/72	Total Cooling	63500	60900	58400	55800	53300	51000	48600	46400	44300	42000	39900
		Sensible Cooling	38800	38000	37200	36300	35300	34400	33400	32400	31300	30300	29100
W60AF	75/62	Total Cooling	66300	61300	56800	53000	49600	46900	44500	42600	41200	40200	39500
		Sensible Cooling	50400	47500	44900	42800	41000	39600	38500	37700	37300	37200	37300
	80/67	Total Cooling	70800	66800	63100	59900	57000	54600	52500	50800	49600	48700	48100
		Sensible Cooling	48900	46600	44500	42800	41400	40300	39500	39000	38800	38900	39300
	85/72	Total Cooling	84300	78100	72500	67600	63300	59700	56600	54100	52100	50600	49500
		Sensible Cooling	50100	47300	44700	42500	40600	39000	37700	36600	35700	35200	34800
W72AF	75/62	Total Cooling	80300	75000	70300	66300	62700	59700	57300	55200	53800	52600	52000
		Sensible Cooling	58700	56000	53700	51600	49800	48300	47000	46000	45200	44500	44200
	80/67	Total Cooling	85700	81700	78100	74900	72000	69600	67600	65900	64700	63800	63400
		Sensible Cooling	56900	54900	53200	51600	50300	49200	48200	47500	47000	46600	46500
	85/72	Total Cooling	102100	95500	89700	84600	80000	76100	72900	70100	68000	66300	65200
		Sensible Cooling	58300	55700	53400	51300	49300	47600	45900	44500	43300	42100	41100

- Notes:
- Unit compressor cooling operation below 60°F requires a Low Ambient Control (LAC).
 - 1000 BTUH = .29307 kW
 - Outdoor air temperatures provided are an average of the condenser inlet air temperature.

Capacity Multiplier Factors							
% of Rated Airflow	-30%	-20%	-10%	Rated	+10%	+20%	+30%
Total BTUH	0.93	0.95	0.97	1	1.01	1.02	1.04
Sensible BTUH	0.90	0.93	0.95	1	1.02	1.05	1.09

1 TON W12A (12,000 BTUH) CABINET AND UNIT DIMENSIONS

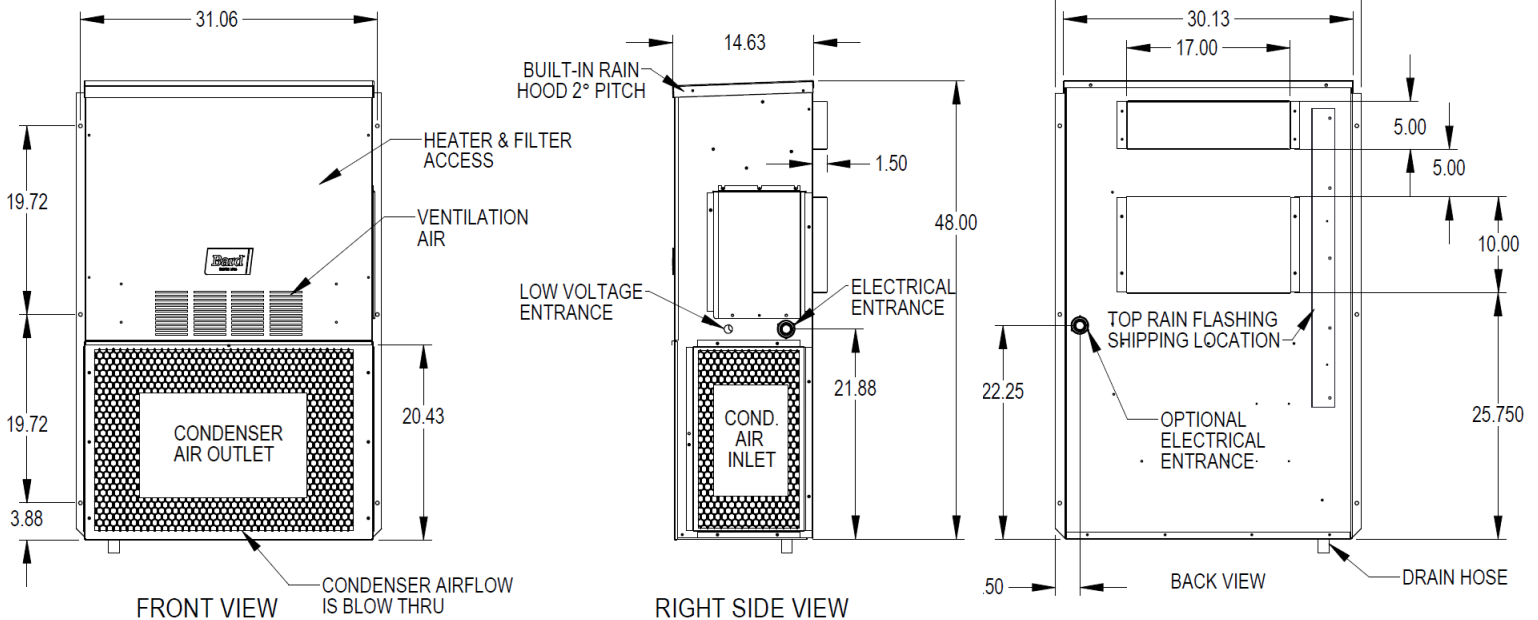

CLEARANCES REQUIRED FOR SERVICE AND CONDENSER AIRFLOW			
MODELS	LEFT SIDE	RIGHT SIDE	FRONT
W12A	15"	20"	10'

MINIMUM CLEARANCES REQUIRED TO COMBUSTIBLE MATERIALS		
MODELS ①	SUPPLY AIR DUCT FIRST 3 FT.	CABINET
W12A	0"	0"

① Refer to the Installation Manual for more detailed information.



1.5 TON W18A (18,000 BTUH) TO 3 TON W36A (36,000 BTUH) RIGHT SIDE CONTROLS CABINET DIMENSIONS

DIMENSIONS OF W18-36A BASIC UNIT FOR ARCHITECTURAL & INSTALLATION REQUIREMENTS (NOMINAL)																						
MODEL	WIDTH (W)	DEPTH (D)	HEIGHT (H)	SUPPLY				RETURN				UNIT CABINET										
				A	B	C	D	E	F	G	I	J	K	L	M	N	O	P	Q	R	S	T
W18A W24A	33.30	17.13	74.56	7.88	19.88	11.88	19.88	35.00	10.88	29.75	20.56	30.75	32.06	33.25	31	2.63	34.13	26.06	10.55	3.94	12	9
W30A W36A	38.20	17.13	74.56	7.88	27.88	13.88	27.88	40.00	10.88	29.75	17.93	30.75	32.75	33.25	31	2.75	39.13	26.75	9.14	3.94	12	9

CLEARANCES REQUIRED FOR SERVICE AND CONDENSER AIRFLOW

MODELS	LEFT SIDE	RIGHT SIDE	FRONT
W18A, W24A W30A, W36A	15"	20"	10'

MINIMUM CLEARANCES REQUIRED TO COMBUSTIBLE MATERIALS

MODELS ①	SUPPLY AIR DUCT FIRST 3 FT.	CABINET
W18A, W24A	0"	0"
W30A, W36A	1/4"	0"

① Refer to the Installation Manual for more detailed information.

Note:
Opposing units that face each other require 15' clearance between condenser outlets.

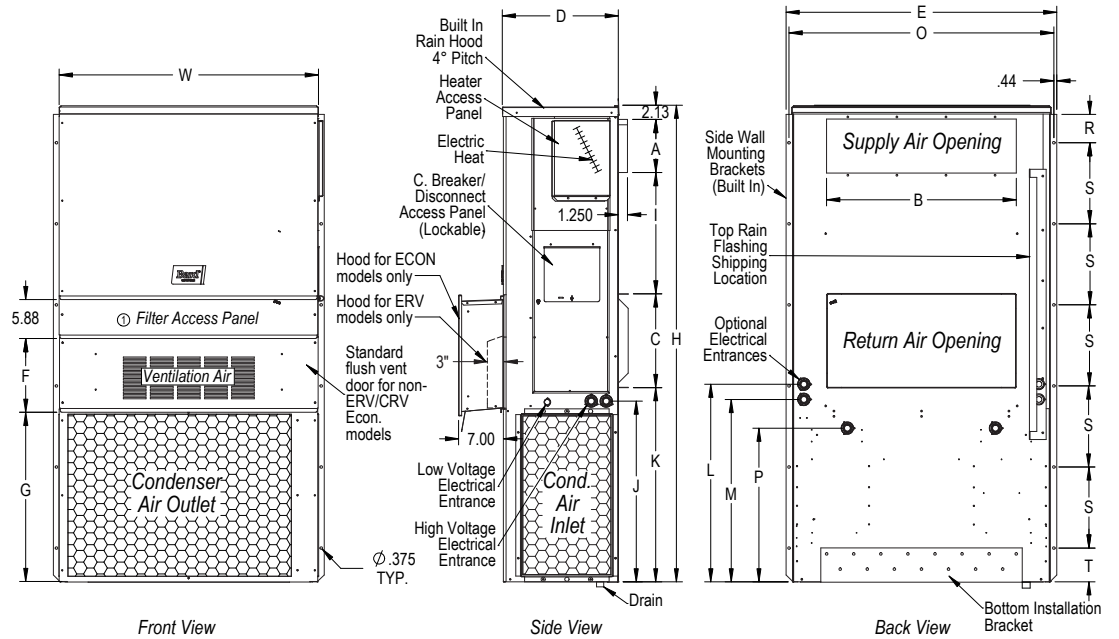

MIS-3796 B

1.5 TON W18L (18,000 BTUH) TO 3 TON W36L (36,000 BTUH) LEFT SIDE CONTROLS CABINET DIMENSIONS

DIMENSIONS OF W18-36L BASIC UNIT FOR ARCHITECTURAL & INSTALLATION REQUIREMENTS (NOMINAL)																						
MODEL	WIDTH (W)	DEPTH (D)	HEIGHT (H)	SUPPLY				RETURN				UNIT CABINET										
				A	B	C	B	E	F	G	I	J	K	L	M	N	O	P	Q	R	S	T
W18L W24L	33.30	17.13	74.56	7.88	19.88	11.88	19.88	35.00	10.88	29.75	20.56	30.75	32.06	33.25	31	2.63	34.13	26.06	10.55	3.94	12.00	9.00
W30L W36L	38.20	17.13	74.56	7.88	27.88	13.88	27.88	40.00	10.88	29.75	17.93	30.75	32.75	33.25	31	2.75	39.13	26.75	9.14	3.94	12.00	9.00

CLEARANCES REQUIRED FOR SERVICE AND CONDENSER AIRFLOW

MODELS	LEFT SIDE	RIGHT SIDE	FRONT
W18L, W24L W30L, W36L	20"	15"	10'

MINIMUM CLEARANCES REQUIRED TO COMBUSTIBLE MATERIALS

MODELS ①	SUPPLY AIR DUCT FIRST 3 FT.	CABINET
W18L, W24L	0"	0"
W30L, W36L	1/4"	0"

① Refer to the Installation Manual for more detailed information.

Note:
Opposing units that face each other require 15' clearance between condenser outlets.

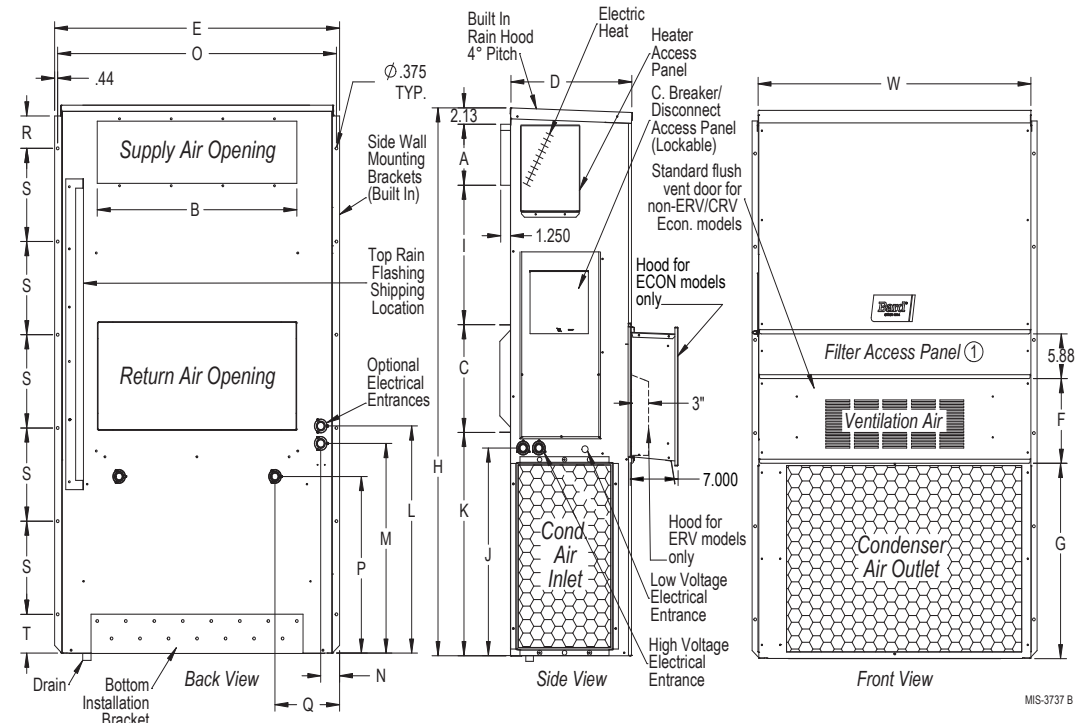

MIS-3737 B



/////// 3.5 TON W42A (42,000 BTUH) TO 6 TON W72A (72,000 BTUH) CENTER CONTROLS CABINET DIMENSIONS

DIMENSIONS OF W42-72A BASIC UNIT FOR ARCHITECTURAL & INSTALLATION REQUIREMENTS (NOMINAL)																						
MODEL	WIDTH (W)	DEPTH (D)	HEIGHT (H)	SUPPLY		RETURN		UNIT CABINET														
				A	B	C	B	E	F	G	I	J	K	L	M	N	O	R	S	T	U	V
W42A W48A	42	25.52	84.88	9.88	29.88	15.88	29.88	43.88	12.63	39.06	30	53.75	26.94	55.59	52.59	8.82	43	1.438	16	1.88	10.50	12.00
W60A W72A	42	25.52	93.00	9.88	29.88	15.88	29.88	43.88	12.63	45	30	59.75	35.06	61.72	58.72	8.82	43	1.438	16	10	13.88	15.43

CLEARANCES REQUIRED FOR SERVICE AND CONDENSER AIRFLOW

MODELS	LEFT SIDE	RIGHT SIDE	FRONT
W42A, W48A W60A, W72A	20"	20"	10'

ECONOMIZER, ERV, OR CRV VENTS REQUIRE 40" ON EITHER RIGHT OR LEFT SIDE FOR INSTALLATION OR REMOVAL. SEE INSTALLATION INSTRUCTIONS FOR MORE INFORMATION.

MINIMUM CLEARANCES REQUIRED TO COMBUSTIBLE MATERIALS

MODELS	SUPPLY AIR DUCT FIRST 3 FT.	CABINET
W42A, W48A W60A, W72A	1/4"	0"

Refer to the Installation Manual for more detailed information.

Note:

Opposing units that face each other require 15' clearance between condenser outlets.

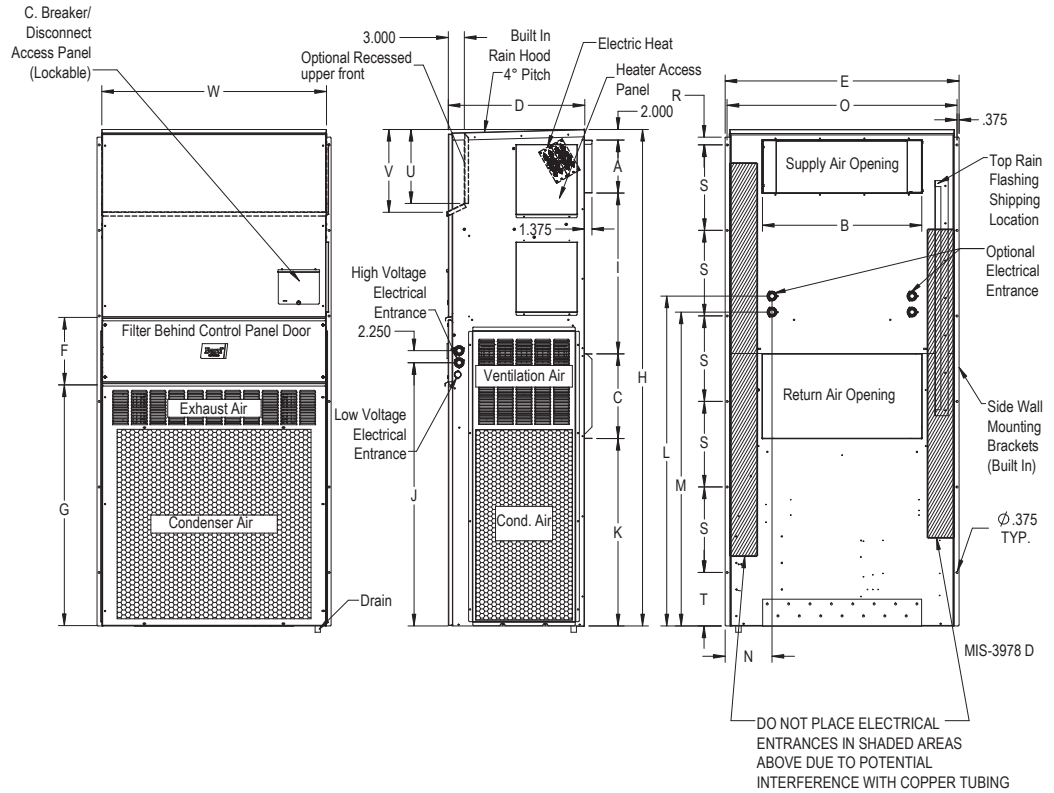

/////// SOUND DATA - DBA @ 5 FT. AND 10 FT.*

UNIT	DUCT FREE IN-DOOR COOLING OPERATION @ 5 FT.	DUCT FREE INDOOR COOLING OPERATION @ 10 FT.	DUCTED INDOOR COOLING OPERATION @ 5 FT.	DUCTED INDOOR COOLING OPERATION @ 10 FT.	OUTDOOR @ 10 FT.
W12A	NA	NA	NA	NA	65.2
W18A/W18L	49.6	47.3	48.6	46.2	62.8
W24A/W24L	52.4	50.4	51.9	48.9	62.3
W30A/W30L	53.9	52.9	54.5	47.3	67.1
W36A/W36L	53.9	52.9	54.5	47.3	67.1
W42A	56.1	51.7	56.3	51.1	68.6
W48A	57	52.7	57.8	52.8	69
W60A	56.5	53.3	56	52.7	66.8
W72A	61.2	56.6	60.8	57.1	77.1

Integrated values calculated per ANSI/ASA S12.60-2009/Part 2, Section 5.2.2.1.



////// GENERAL UNIT ELECTRICAL SPECIFICATIONS

MODELS	CONTROL PANEL CABINET LOCATION	NOMINAL VOLTAGE VAC	PH	HZ	VOLTAGE RANGE VAC	RATED LOAD AMPS (RLA)	BRANCH CIRCUIT SELECTION CURRENT (BCSC)	LOCKED ROTOR AMPS (LRA)	INDOOR MOTOR VOLTAGE	INDOOR MOTOR AMPS	INDOOR MOTOR HP	OUTDOOR MOTOR AMPS	OUTDOOR MOTOR HP
W12AF-K	Right Side	115V	1	60	104-126V	11.3A	9.9	52A	115V	1.3A	1/8	1.0A	1/12
W12AF-A	Right Side	230/208V	1	60	197-253V	5.7/6.2A	5.2A	26A	230V	.9A	1/8	.5A	1/12
W18AF-A	Right Side	230/208V	1	60	197-253V	7.8/8.8A	8.3A	45.1A	230V	.8A	1/3	1.0A	1/5
W18LF-A	Left Side												
W24AF-A	Right Side	230/208V	1	60	197-253V	11.1/12.7A	11.4A	64.4A	230V	1.3A	1/3	1.0A	1/5
W24LF-A	Left Side												
W24AF-B	Right Side	230/208V	3	60	197-253V	7.5/8.6A	7.7A	59.9A	230V	1.3A	1/3	1.0A	1/5
W24LF-B	Left Side												
W24AF-C	Right Side	460V	3	60	414-506V	5.0A	4.5A	32.4A	460V	.7A	1/3	.5A	1/5
W30AF-A	Right Side	230/208V	1	60	197-253V	12.6/14.6A	12.7A	75.6A	230V	1.7A	1/2	1.4A	1/5
W30LF-A	Left Side												
W30AF-B	Right Side	230/208V	3	60	197-253V	9.6/11.1A	9.6A	67.7A	230V	1.7A	1/2	1.4A	1/5
W30LF-B	Left Side												
W30AF-C	Right Side	460V	3	60	414-506V	6.7A	5.8A	38.1A	460V	.9A	1/2	.7A	1/5
W30LF-C	Left Side												
W36AF-A	Right Side	230/208V	1	60	197-253V	16.5/18.8A	16.7A	93.5A	230V	2.5A	1/2	1.3A	1/5
W36LF-A	Left Side												
W36AF-B	Right Side	230/208V	3	60	197-253V	12.1/13.8A	12.2A	97.5A	230V	2.5A	1/2	1.3A	1/5
W36LF-B	Left Side												
W36AF-C	Right Side	460V	3	60	414-506V	6.6A	5.8A	44.3A	460V	1.3A	1/2	.7A	1/5
W36LF-C	Left Side												
W36AFRC	Right Side	460V	3	60	414-506V	6.6A	5.8A	44.3A	230V	2.5A	1/2	.7A	1/5
W36LFRC	Left Side												
W42AF-A	Unit Front	230/208V	1	60	197-253V	18.8/21.5	18.6	123	230V	1.8/2	1/2	2/1.9	1/3
W42AF-B	Unit Front	230/208V	3	60	197-253V	13/14.9	12.8	102.8	230V	1.8/2	1/2	2/1.9	1/3
W42AF-C	Unit Front	460V	3	60	414-506V	6.7	5.8	50	460V	1	1/2	1	1/3
W42AFRC	Unit Front	460V	3	60	414-506V	6.7	5.8	50	230V	1.8	1/2	1	1/3
W48AF-A	Unit Front	230/208V	1	60	197-253V	21.6/24.9	22.4	126	230V	3.1/3.2	3/4	1.9	1/3
W48AF-B	Unit Front	230/208V	3	60	197-253V	12.4/14.3	12.8	120.4	230V	3.1/3.2	3/4	1.9	1/3
W48AF-C	Unit Front	460V	3	60	414-506V	7.9	6.0	49.4	460V	1.6	3/4	1	1/3
W48AF-Q	Unit Front	575V	3	60	520-630V	6.4	5.8	41	230V	1.8	3/4	2	1/3
W48AFRC	Unit Front	460V	3	60	414-506V	7.9	6.0	49.4	230V	3.1	3/4	1	1/3
W60AF-A	Unit Front	230/208V	1	60	197-253V	26.9/31.1	23.7	157	230V	3.4/3.6	3/4	1.8/1.9	1/3
W60AF-B	Unit Front	230/208V	3	60	197-253V	24.6/28.5	16.0	156.4	230V	3.4/3.6	3/4	1.8/1.9	1/3
W60AF-C	Unit Front	460V	3	60	414-506V	12.1	7.1	69	460V	1.8	3/4	1	1/3
W60AF-Q	Unit Front	575V	3	60	520-630V	7.1	6.4	47.8	230V	2	3/4	2	1/3
W60AFRC	Unit Front	460V	3	60	414-506V	12.1	7.1	69	230V	3.4	3/4	1	1/3
W72AF-A	Unit Front	230/208V	1	60	197-253V	37.8/42.1	32.8	183.9	230V	4.3/4.6	3/4	3.7/3.8	1/2
W72AF-B	Unit Front	230/208V	3	60	197-253V	25.8/28.7	22.4	166.2	230V	4.3/4.6	3/4	3.7/3.8	1/2
W72AF-C	Unit Front	460V	3	60	414-506V	11.4	8.8	74.6	460V	2.3	3/4	1.9	1/2
W72AF-Q	Unit Front	575V	3	60	520-630V	8	7.2	54	230V	4.6	3/4	3.8	1/3
W72AFRC	Unit Front	460V	3	60	414-506V	11.4	8.8	74.6	230V	4.3	3/4	1.9	1/2

Note: All units have a Short Circuit Current Protection Rating (SCCR) of 5kA RMS Symmetrical.



GENERAL UNIT REFRIGERANT AND MECHANICAL SPECIFICATIONS

UNIT MODEL	REFRIGERANT SYSTEM				INDOOR EVAPORATOR BLOWER			OUTDOOR CONDENSER FAN		
	CHARGE TYPE	STANDARD UNIT CHARGE RATE	DEHUMIDIFICATION UNIT CHARGE RATE	COMPRESSOR TYPE	INDOOR MOTOR - SPEEDS	INDOOR FAN	INDOOR CFM - RATED ESP	OUTDOOR MOTOR	OUTDOOR FAN	OUTDOOR FAN CFM
W12	R-454B	3.00 lbs.	N/A	Rotary	ECM-1SPD	Dual Blower	425 - .10	PSC	18" Axial	950
W18	R-454B	3.13 lbs.	N/A	Scroll	ECM-5SPD	Dual Blower	600 - .10	PSC	18" Axial	1800
W24	R-454B	3.88 lbs.	N/A	Scroll	ECM-5SPD	Dual Blower	800 - .10	PSC	18" Axial	1800
W30	R-454B	3.44 lbs.	3.38 lbs.	Scroll	ECM-5SPD	Dual Blower	950 - .15	PSC	20" Axial	2400
W36	R-454B	3.75 lbs.	3.88 lbs.	Scroll	ECM-5SPD	Dual Blower	1150 - .15	PSC	20" Axial	2400
W42	R-454B	6.06 lbs.	6.00 lbs.	Scroll	ECM-5SPD	Dual Blower	1350 - .15	PSC	24" Axial	2900
W48	R-454B	6.00 lbs.	6.50 lbs.	Scroll	ECM-5SPD	Dual Blower	1550 - .20	PSC	24" Axial	3000
W60	R-454B	7.94 lbs.	7.50 lbs.	Scroll	ECM-5SPD	Dual Blower	1750 - .20	PSC	24" Axial	3100
W72	R-454B	8.31 lbs.	8.25 lbs.	Scroll	ECM-5SPD	Dual Blower	1900 - .25	PSC	24" Axial	4000

AVAILABLE HEATER PACKAGES AND FIELD WIRING DATA - W12A TO W24A STANDARD UNITS

UNIT MODEL	KW OPTION	RATED VOLTAGE AND PHASE (60HZ)	CONNECTION POINT	NO. OF FIELD CIRCUITS	SINGLE CIRCUIT		FIELD INSTALLED HEATER KIT PART NUMBERS. HEATERS CAN BE FACTORY OR FIELD INSTALLED FOR ALL MODELS EXCEPT W12
					MINIMUM CIRCUIT AMPACITY (MCA)	MAX. OVER CURRENT PROTECTION (MOCP)	
W12AF-K	00	115-1	LUGS	1	15	20	NOT NEEDED
	02	115-1	C BREAKER	1	25	25	NOT AVAILABLE
W12AF-A	0Z	230/208-1	C BREAKER	1	8	15	NOT AVAILABLE
	03	230/208-1	C BREAKER	1	19	25	NOT AVAILABLE
	05	230/208-1	C BREAKER	1	28	30	NOT AVAILABLE
W18AF-A	00	230/208-1	LUGS	1	15	20	NOT NEEDED
	0Z	230/208-1	C BREAKER	1	15	20	WMCB-02A
	05	230/208-1	C BREAKER	1	30	30	EHWA018A-A05
	08	230/208-1	C BREAKER	1	46	50	EHWA018A-A08
	10	230/208-1	C BREAKER	1	56	60	EHWA018A-A10
W24AF-A	00	230/208-1	LUGS	1	19	25	NOT NEEDED
	0Z	230/208-1	C BREAKER	1	19	25	WMCB-03A
	05	230/208-1	C BREAKER	1	31	35	EHWA024A-A05
	08	230/208-1	C BREAKER	1	46	50	EHWA018A-A08
	10	230/208-1	C BREAKER	1	57	60	EHWA018A-A10
W24AF-B	00	230/208-3	LUGS	1	15	20	NOT NEEDED
	0Z	230/208-3	C BREAKER	1	15	20	WMCB-02B
	05	230/208-3	C BREAKER	1	20	20	EHWA024A-B05
W24AF-C	00	460-3	DISCONNECT	1	8	15	NOT NEEDED
	0Z	460-3	DISCONNECT	1	8	15	WMPD-01C
	05	460-3	DISCONNECT	1	10	15	EHWA024A-C05

CAUTION: When more than one field power circuit is run through one conduit, the conductors must be de-rated. Pay special attention to Note 8 of Table 310 regarding Ampacity Adjustment Factors when more than three current carrying conductors are in a raceway.

IMPORTANT: While this electrical data is presented as a guide, it is important to electrically connect properly sized fuses and conductor wires in accordance with the National Electrical Code and all local codes. MOCP (Maximum Over-current Protection) value listed is the maximum value as per UL 60335 calculations for MOCP (branch-circuit conductor sizes in this chart are based on this MOCP). The actual factory installed Over-current Protective Device (Circuit Breaker) in this model may be lower than the maximum UL 60335 allowable MOCP value, but still above the UL 60335 minimum calculated value or Minimum Circuit Ampacity (MCA) listed. Refer to the National Electrical code (latest version), Article 310 for power conductor sizing. Review all wiring and safety information provided in the installation manual for the product.



////// AVAILABLE HEATER PACKAGES AND FIELD WIRING DATA - W30A TO W42A STANDARD UNITS

UNIT MODEL	KW OPTION	RATED VOLTAGE AND PHASE (60HZ)	CONNECTION POINT	NO. OF FIELD CIRCUITS	SINGLE CIRCUIT		DUAL CIRCUIT				FIELD INSTALLED HEATER KIT PART NUMBERS. HEATERS CAN BE FACTORY OR FIELD INSTALLED.
					MINIMUM CIRCUIT AMPACITY (MCA)	MAX. OVER CURRENT PROTECTION (MOCP)	MCA		MOCP		
							CKT. A	CKT. B	CKT. A	CKT. B	
W30AF-A	00	230/208-1	LUGS	1	22	25					NOT NEEDED
	0Z	230/208-1	C BREAKER	1	22	25					WMCB-03A
	05	230/208-1	C BREAKER	1	31	35					EHWA030A-A05
	10	230/208-1	C BREAKER	1	57	60					EHWA030A-A10
	15	230/208-1	C BREAKER	1 OR 2	83	90	57	26	60	30	EHWA030A-A15
W30AF-B	00	230/208-3	LUGS	1	18	20					NOT NEEDED
	0Z	230/208-3	C BREAKER	1	18	20					WMCB-02B
	05	230/208-3	C BREAKER	1	20	20					EHWA024A-B05
	09	230/208-3	C BREAKER	1	32	35					EHWA030A-B09
	15	230/208-3	C BREAKER	1	51	60					EHWA030B-B15
W30AF-C	00	460-3	LUGS	1	10	15					NOT NEEDED
	0Z	460-3	C BREAKER	1	10	15					WMPD-01C
	05	460-3	C BREAKER	1	11	15					EHWA030A-C05
	09	460-3	C BREAKER	1	17	20					EHWA030A-C09
	15	460-3	C BREAKER	1	26	30					EHWA030A-C15
W36AF-A	00	230/208-1	LUGS	1	27	35					NOT NEEDED
	0Z	230/208-1	C BREAKER	1	27	35					WMCB-05A
	05	230/208-1	C BREAKER	1	32	35					EHWA024A-A05
	10	230/208-1	C BREAKER	1	58	60					EHWA030A-A10
	15	230/208-1	C BREAKER	1 OR 2	84	90	58	26	60	30	EHWA036A-A15
W36AF-B	00	230/208-3	LUGS	1	22	25					NOT NEEDED
	0Z	230/208-3	C BREAKER	1	22	25					WMCB-03B
	05	230/208-3	C BREAKER	1	22	25					EHWA036A-B05
	09	230/208-3	C BREAKER	1	33	35					EHWA030A-B09
	15	230/208-3	C BREAKER	1	52	60					EHWA036A-B15
W36AF-C	00	460-3	LUGS	1	11	15					NOT NEEDED
	0Z	460-3	C BREAKER	1	11	15					WMPD-01C
	05	460-3	C BREAKER	1	11	15					EHWA036A-C05
	09	460-3	C BREAKER	1	17	20					EHWA036A-C09
	15	460-3	C BREAKER	1	26	30					EHWA036A-C15
W42AF-A	00	230/208-1	LUGS	1	30	35					NOT NEEDED
	0Z	230/208-1	C BREAKER	1	30	35					WMCBC-05A
	05	230/208-1	C BREAKER	1	32	35					EHWA042B-A05
	10	230/208-1	C BREAKER	1	58	60					EHWA042A-A10
	15	230/208-1	C BREAKER	1	84	90					EHWA042A-A15
W42AF-B	00	230/208-3	LUGS	1	23	30					NOT NEEDED
	0Z	230/208-3	C BREAKER	1	23	30					WMCBC-04B
	05	230/208-3	C BREAKER	1	23	30					EHWA042A-B05
	09	230/208-3	C BREAKER	1	33	35					EHWA042A-B09
	15	230/208-3	C BREAKER	1	51	60					EHWA042A-B15
W42AF-C	00	460-3	LUGS	1	11	15					NOT NEEDED
	0Z	460-3	DISCONNECT	1	11	15					WMCBC-06C
	09	460-3	DISCONNECT	1	17	20					EHWA042A-C09
	15	460-3	DISCONNECT	1	26	30					EHWA042A-C15

SEE ELECTRICAL NOTES ON NEXT PAGE.



////// AVAILABLE HEATER PACKAGES AND FIELD WIRING DATA - W48A TO W60A STANDARD UNITS

UNIT MODEL	KW OPTION	RATED VOLTAGE AND PHASE (60HZ)	CONNECTION POINT	NO. OF FIELD CIRCUITS	SINGLE CIRCUIT		DUAL CIRCUIT				FIELD INSTALLED HEATER KIT PART NUMBERS. HEATERS CAN BE FACTORY OR FIELD INSTALLED.
					MINIMUM CIRCUIT AMPACITY (MCA)	MAX. OVER CURRENT PROTECTION (MOCP)	MCA		MOCP		
							CKT. A	CKT. B	CKT. A	CKT. B	
W48AF-A	00	230/208-1	LUGS	1	36	45					NOT NEEDED
	0Z	230/208-1	C BREAKER	1	36	45					WMCBC-07A
	05	230/208-1	C BREAKER	1	36	45					EHWA048ADA05
	10	230/208-1	C BREAKER	1	59	60					EHWA048A-A10
	15	230/208-1	C BREAKER	1	85	90					EHWA048A-A15
W48AF-B	00	230/208-3	LUGS	1	24	30					NOT NEEDED
	0Z	230/208-3	C BREAKER	1	24	30					WMCBC-04B
	05	230/208-3	C BREAKER	1	24	30					EHWA048A-B05
	09	230/208-3	C BREAKER	1	34	35					EHWA048A-B09
	15	230/208-3	C BREAKER	1	52	60					EHWA048A-B15
W48AF-C	00	460-3	LUGS	1	12	15					NOT NEEDED
	0Z	460-3	DISCONNECT	1	12	15					WMCBC-06C
	09	460-3	DISCONNECT	1	17	20					EHWA048A-C09
	15	460-3	DISCONNECT	1	26	30					EHWA048A-C15
W48AF-Q	00	575-3	LUGS	1	8	15					NOT NEEDED
	0Z	575-3	DISCONNECT	1	8	15					WMCBC-06C
	15	575-3	DISCONNECT	1	19	20					EHWA060A-Q15
W60AF-A	00	230/208-1	LUGS	1	38	45					NOT NEEDED
	0Z	230/208-1	C BREAKER	1	38	45					WMCBC-07A
	05	230/208-1	C BREAKER	1	38	45					EHWA060B-A05
	10	230/208-1	C BREAKER	1	60	60					EHWA060A-A10
	15	230/208-1	C BREAKER	1 or 2	86	90	60	26	60	30	EHWA060A-A15
W60AF-B	00	230/208-3	LUGS	1	28	35					NOT NEEDED
	0Z	230/208-3	C BREAKER	1	28	35					WMCBC-05B
	09	230/208-3	C BREAKER	1	35	35					EHWA042A-B09
	15	230/208-3	C BREAKER	1	53	60					EHWA060A-B15
W60AF-C	00	460-3	LUGS	1	13	15					NOT NEEDED
	0Z	460-3	DISCONNECT	1	13	15					WMCBC-06C
	09	460-3	DISCONNECT	1	18	20					EHWA042A-C09
	15	460-3	DISCONNECT	1	27	30					EHWA042A-C15
W60AF-Q	00	575-3	LUGS	1	14	15					NOT NEEDED
	0Z	575-3	DISCONNECT	1	14	15					WMCBC-06C
	15	575-3	DISCONNECT	1	23	25					EHWA060A-Q15

CAUTION: When more than one field power circuit is run through one conduit, the conductors must be de-rated. Pay special attention to Note 8 of Table 310 regarding Ampacity Adjustment Factors when more than three current carrying conductors are in a raceway.

IMPORTANT: While this electrical data is presented as a guide, it is important to electrically connect properly sized fuses and conductor wires in accordance with the National Electrical Code and all local codes. MOCP (Maximum Over-current Protection) value listed is the maximum value as per UL 60335 calculations for MOCP (branch-circuit conductor sizes in this chart are based on this MOCP). The actual factory installed Over-current Protective Device (Circuit Breaker) in this model may be lower than the maximum UL 60335 allowable MOCP value, but still above the UL 60335 minimum calculated value or Minimum Circuit Ampacity (MCA) listed. Refer to the National Electrical code (latest version), Article 310 for power conductor sizing. Review all wiring and safety information provided in the installation manual for the product.



////// AVAILABLE HEATER PACKAGES AND FIELD WIRING DATA - W72A STANDARD UNITS

UNIT MODEL	KW OPTION	RATED VOLTAGE AND PHASE (60HZ)	CONNECTION POINT	NO. OF FIELD CIRCUITS	SINGLE CIRCUIT		DUAL CIRCUIT				FIELD INSTALLED HEATER KIT PART NUMBERS. HEATERS CAN BE FACTORY OR FIELD INSTALLED.
					MINIMUM CIRCUIT AMPACITY (MCA)	MAX. OVER CURRENT PROTECTION (MOCP)	MCA		MOCP		
							CKT. A	CKT. B	CKT. A	CKT. B	
W72AF-A	00	230/208-1	LUGS	1	52	60					NOT NEEDED
	0Z	230/208-1	C BREAKER	1	52	60					WMCBC-09A
	05	230/208-1	C BREAKER	1	52	60					EHWA072A-A05
	10	230/208-1	C BREAKER	1 or 2	61	70	52	52	60	60	EHWA072A-A10
	15	230/208-1	C BREAKER	1 or 2	87	90	52	52	60	60	EHWA072A-A15
W72AF-B	00	230/208-3	LUGS	1	39	45					NOT NEEDED
	0Z	230/208-3	C BREAKER	1	39	45					WMCBC-07B
	09	230/208-3	C BREAKER	1	39	45					EHWA072A-B09
	15	230/208-3	C BREAKER	1	54	60					EHWA060A-B15
W72AF-C	00	460-3	LUGS	1	17	20					NOT NEEDED
	0Z	460-3	DISCONNECT	1	17	20					WMCBC-06C
	09	460-3	DISCONNECT	1	18	20					EHWA042A-C09
	15	460-3	DISCONNECT	1	27	30					EHWA042A-C15
W72AF-Q	00	575-3	LUGS	1	9	15					NOT NEEDED
	0Z	575-3	DISCONNECT	1	9	15					WMCBC-06C
	15	575-3	DISCONNECT	1	19	20					EHWA060A-Q15

////// AVAILABLE HEATER PACKAGES AND FIELD WIRING DATA - W18L TO W30L LEFT SIDE CONTROL PANEL UNITS

UNIT MODEL	KW OPTION	RATED VOLTAGE AND PHASE (60HZ)	CONNECTION POINT	NO. OF FIELD CIRCUITS	SINGLE CIRCUIT		DUAL CIRCUIT				FIELD INSTALLED HEATER KIT PART NUMBERS. HEATERS CAN BE FACTORY OR FIELD INSTALLED.
					MINIMUM CIRCUIT AMPACITY (MCA)	MAX. OVER CURRENT PROTECTION (MOCP)	MCA		MOCP		
							CKT. A	CKT. B	CKT. A	CKT. B	
W18LF-A	0Z	230/208-1	C BREAKER	1	15	20					WMCB-02AL
	05	230/208-1	C BREAKER	1	30	30					EHWL018A-A05
	10	230/208-1	C BREAKER	1	56	60					EHWL018A-A10
W24LF-A	0Z	230/208-1	C BREAKER	1	19	25					WMCB-03AL
	05	230/208-1	C BREAKER	1	31	35					EHWL024A-A05
	10	230/208-1	C BREAKER	1	57	60					EHWL018A-A10
W24LF-B	0Z	230/208-3	C BREAKER	1	15	20					WMCB-02BL
	05	230/208-3	C BREAKER	1	20	20					EHWL024A-B05
W30LF-A	0Z	230/208-1	C BREAKER	1	22	25					WMCB-03AL
	05	230/208-1	C BREAKER	1	31	35					EHWL030A-A05
	10	230/208-1	C BREAKER	1	57	60					EHWL030A-A10
	15	230/208-1	C BREAKER	1 OR 2	83	90	57	26	60	30	EHWL030A-A15
W30LF-B	0Z	230/208-3	C BREAKER	1	18	20					WMCB-02BL
	09	230/208-3	C BREAKER	1	32	35					EHWL030A-B09
	15	230/208-3	C BREAKER	1	51	60					EHWL030B-B15
W30LF-C	0Z	460-3	DISCONNECT	1	10	15					WMPD-01CL
	09	460-3	DISCONNECT	1	17	20					EHWL030A-C09
	15	460-3	DISCONNECT	1	26	30					EHWL030A-C15

CAUTION: When more than one field power circuit is run through one conduit, the conductors must be de-rated. Pay special attention to Note 8 of Table 310 regarding Ampacity Adjustment Factors when more than three current carrying conductors are in a raceway.

IMPORTANT: While this electrical data is presented as a guide, it is important to electrically connect properly sized fuses and conductor wires in accordance with the National Electrical Code and all local codes. MOCP (Maximum Over-current Protection) value listed is the maximum value as per UL 60335 calculations for MOCP (branch-circuit conductor sizes in this chart are based on this MOCP). The actual factory installed Over-current Protective Device (Circuit Breaker) in this model may be lower than the maximum UL 60335 allowable MOCP value, but still above the UL 60335 minimum calculated value or Minimum Circuit Ampacity (MCA) listed. Refer to the National Electrical code (latest version), Article 310 for power conductor sizing. Review all wiring and safety information provided in the installation manual for the product.



////// AVAILABLE HEATER PACKAGES AND FIELD WIRING DATA - W36L LEFT SIDE CONTROL PANEL UNITS

UNIT MODEL	KW OPTION	RATED VOLTAGE AND PHASE (60HZ)	CONNECTION POINT	NO. OF FIELD CIRCUITS	SINGLE CIRCUIT		DUAL CIRCUIT				FIELD INSTALLED HEATER KIT PART NUMBERS. HEATERS CAN BE FACTORY OR FIELD INSTALLED.
					MINIMUM CIRCUIT AMPACITY (MCA)	MAX. OVER CURRENT PROTECTION (MOCP)	MCA		MOCP		
							CKT. A	CKT. B	CKT. A	CKT. B	
W36LF-A	0Z	230/208-1	C BREAKER	1	27	35					WMCB-05AL
	05	230/208-1	C BREAKER	1	32	35					EHWL024A-A05
	10	230/208-1	C BREAKER	1	58	60					EHWL030A-A10
	15	230/208-1	C BREAKER	1 OR 2	84	90	58	26	60	30	EHWL036A-A15
W36LF-B	0Z	230/208-3	C BREAKER	1	22	25					WMCB-03BL
	09	230/208-3	C BREAKER	1	33	35					EHWL030A-B09
	15	230/208-3	C BREAKER	1	52	60					EHWL036A-B15
W36LF-C	0Z	460-3	DISCONNECT	1	11	15					WMPD-01CL
	09	460-3	DISCONNECT	1	17	20					EHWL036A-C09
	15	460-3	DISCONNECT	1	26	30					EHWL036A-C15

////// AVAILABLE HEATER PACKAGES AND FIELD WIRING DATA - W30A TO W42A "D" DEHUMIDIFICATION UNITS

UNIT MODEL	KW OPTION	RATED VOLTAGE AND PHASE (60HZ)	CONNECTION POINT	NO. OF FIELD CIRCUITS	SINGLE CIRCUIT		DUAL CIRCUIT				FIELD INSTALLED HEATER KIT PART NUMBERS. HEATERS CAN BE FACTORY OR FIELD INSTALLED.
					MINIMUM CIRCUIT AMPACITY (MCA)	MAX. OVER CURRENT PROTECTION (MOCP)	MCA		MOCP		
							CKT. A	CKT. B	CKT. A	CKT. B	
W30AFDA	0Z	230/208-1	C BREAKER	1	22	25					WMCB-03A
	05	230/208-1	C BREAKER	1	31	35					EHWA030A-A05
	10	230/208-1	C BREAKER	1	57	60					EHWA030A-A10
W30AFDB	0Z	230/208-3	C BREAKER	1	18	20					WMCB-02B
	05	230/208-3	C BREAKER	1	20	20					EHWA024A-B05
	09	230/208-3	C BREAKER	1	33	35					EHWA030A-B09
W30AFDC	0Z	460-3	DISCONNECT	1	9	15					WMPD-01C
	05	460-3	DISCONNECT	1	11	15					EHWA030ADC05
	09	460-3	DISCONNECT	1	17	20					EHWA030A-C09
W36AFDA	0Z	230/208-1	C BREAKER	1	27	35					WMCB-05A
	05	230/208-1	C BREAKER	1	32	35					EHWA036ADA05
	10	230/208-1	C BREAKER	1	58	60					EHWA036ADA10
W36AFDB	0Z	230/208-3	C BREAKER	1	22	25					WMCB-03B
	05	230/208-3	C BREAKER	1	22	25					EHWA036A-B05
	09	230/208-3	C BREAKER	1	33	35					EHWA036ADB09
W36AFDC	0Z	460-3	DISCONNECT	1	11	15					WMPD-01C
	05	460-3	DISCONNECT	1	11	15					EHWA036ADC05
	09	460-3	DISCONNECT	1	17	20					EHWA036ADC09
W42AFDA	00	230/208-1	LUGS	1	30	35					NOT NEEDED
	0Z	230/208-1	C BREAKER	1	30	35					WMCBC-05A
	05	230/208-1	C BREAKER	1	32	35					EHWA042B-A05
	10	230/208-1	C BREAKER	1	58	60					EHWA042ADA10
	15	230/208-1	C BREAKER	1 or 2	84	90	58	26	60	30	EHWA042A-A15
W42AFDB	00	230/208-3	LUGS	1	23	30					NOT NEEDED
	0Z	230/208-3	C BREAKER	1	23	30					WMCBC-04B
	05	230/208-3	C BREAKER	1	23	30					EHWA042A-B05
	09	230/208-3	C BREAKER	1	33	35					EHWA042A-B09
W42AFDC	00	460-3	LUGS	1	11	15					NOT NEEDED
	0Z	460-3	DISCONNECT	1	11	15					WMCBC-06C
	05	460-3	DISCONNECT	1	11	15					EHWA042ADC05
	09	460-3	DISCONNECT	1	17	20					EHWA042A-C09

SEE ELECTRICAL NOTES ON NEXT PAGE.



//////// AVAILABLE HEATER PACKAGES AND FIELD WIRING DATA - W48A TO W72A "D" DEHUMIDIFICATION UNITS

UNIT MODEL	KW OPTION	RATED VOLTAGE AND PHASE (60HZ)	CONNECTION POINT	NO. OF FIELD CIRCUITS	SINGLE CIRCUIT		DUAL CIRCUIT				FIELD INSTALLED HEATER KIT PART NUMBERS. HEATERS CAN BE FACTORY OR FIELD INSTALLED.
					MINIMUM CIRCUIT AMPACITY (MCA)	MAX. OVER CURRENT PROTECTION (MOCP)	MCA		MOCP		
							CKT. A	CKT. B	CKT. A	CKT. B	
W48AFDA	00	230/208-1	LUGS	1	36	45					NOT NEEDED
	0Z	230/208-1	C BREAKER	1	36	45					WMCBC-07A
	05	230/208-1	C BREAKER	1	36	45					EHWA048ADA05
	10	230/208-1	C BREAKER	1	59	60					EHWA048A-A10
	15	230/208-1	C BREAKER	1 or 2	86	90	59	26	60	30	EHWA048A-A15
W48AFDB	00	230/208-3	LUGS	1	24	30					NOT NEEDED
	0Z	230/208-3	C BREAKER	1	24	30					WMCBC-04B
	05	230/208-3	C BREAKER	1	24	30					EHWA048A-B05
	09	230/208-3	C BREAKER	1	35	35					EHWA048A-B09
W48AFDC	00	460-3	LUGS	1	12	15					NOT NEEDED
	0Z	460-3	DISCONNECT	1	12	15					WMCBC-06C
	05	460-3	DISCONNECT	1	12	15					EHWA048ADC05
	09	460-3	DISCONNECT	1	18	20					EHWA048A-C09
W60AFDA	00	230/208-1	LUGS	1	38	45					NOT NEEDED
	0Z	230/208-1	C BREAKER	1	38	45					WMCBC-07A
	05	230/208-1	C BREAKER	1	38	45					EHWA060B-A05
	10	230/208-1	C BREAKER	1	60	60					EHWA060A-A10
	15	230/208-1	C BREAKER	1 or 2	86	90	60	26	60	30	EHWA060A-A15
W60AFDB	00	230/208-3	LUGS	1	28	35					NOT NEEDED
	0Z	230/208-3	C BREAKER	1	28	35					WMCBC-05B
	09	230/208-3	C BREAKER	1	35	35					EHWA042A-B09
	15	230/208-3	C BREAKER	1	53	60					EHWA060A-B15
W60AFDC	00	460-3	LUGS	1	13	15					NOT NEEDED
	0Z	460-3	DISCONNECT	1	13	15					WMCBC-06C
	09	460-3	DISCONNECT	1	18	20					EHWA042A-C09
	15	460-3	DISCONNECT	1	27	30					EHWA042A-C15
W72AFDA	00	230/208-1	LUGS	1	52	60					NOT NEEDED
	0Z	230/208-1	C BREAKER	1	52	60					WMCBC-09A
	05	230/208-1	C BREAKER	1	52	60					EHWA072A-A05
	10	230/208-1	C BREAKER	1	61	70					EHWA072A-A10
	15	230/208-1	C BREAKER	1 or 2	87	90	52	52	60	30	EHWA072A-A15
W72AFDB	00	230/208-3	LUGS	1	39	45					NOT NEEDED
	0Z	230/208-3	C BREAKER	1	39	45					WMCBC-07B
	09	230/208-3	C BREAKER	1	39	45					EHWA072A-B09
	15	230/208-3	C BREAKER	1	54	60					EHWA060A-B15
W72AFDC	00	460-3	LUGS	1	17	20					NOT NEEDED
	0Z	460-3	DISCONNECT	1	17	20					WMCBC-06C
	09	460-3	DISCONNECT	1	18	20					EHWA042A-C09
	15	460-3	DISCONNECT	1	27	30					EHWA042A-C15

CAUTION: When more than one field power circuit is run through one conduit, the conductors must be de-rated. Pay special attention to Note 8 of Table 310 regarding Ampacity Adjustment Factors when more than three current carrying conductors are in a raceway.

IMPORTANT: While this electrical data is presented as a guide, it is important to electrically connect properly sized fuses and conductor wires in accordance with the National Electrical Code and all local codes. MOCP (Maximum Over-current Protection) value listed is the maximum value as per UL 60335 calculations for MOCP (branch-circuit conductor sizes in this chart are based on this MOCP). The actual factory installed Over-current Protective Device (Circuit Breaker) in this model may be lower than the maximum UL 60335 allowable MOCP value, but still above the UL 60335 minimum calculated value or Minimum Circuit Ampacity (MCA) listed. Refer to the National Electrical code (latest version), Article 310 for power conductor sizing. Review all wiring and safety information provided in the installation manual for the product.



//////// AVAILABLE HEATER PACKAGES AND FIELD WIRING DATA - W36 TO W72 "R" INDOOR MOTOR ISOLATION UNITS

UNIT MODEL	KW OPTION	RATED VOLTAGE AND PHASE (60HZ)	CONNECTION POINT	NO. OF FIELD CIRCUITS	SINGLE CIRCUIT		DUAL CIRCUIT				FIELD INSTALLED HEATER KIT PART NUMBERS. HEATERS CAN BE FACTORY OR FIELD INSTALLED.
					MINIMUM CIRCUIT AMPACITY (MCA)	MAX. OVER CURRENT PROTECTION (MOCP)	MCA		MOCP		
							CKT. A	CKT. B	CKT. A	CKT. B	
W36AFRC	00	460-3	LUGS	1	11	15					NOT NEEDED
	0Z	460-3	C BREAKER	1	11	15					WMPD-01C
	05	460-3	C BREAKER	1	11	15					EHWA036A-C05
	09	460-3	C BREAKER	1	17	20					EHWA036A-C09
	15	460-3	C BREAKER	1	26	30					EHWA036A-C15
W36LFR	0Z	460-3	DISCONNECT	1	11	15					WMPD-01CL
	09	460-3	DISCONNECT	1	17	20					EHWL036A-C09
	15	460-3	DISCONNECT	1	26	30					EHWL036A-C15
W42AFRC	00	460-3	LUGS	1	17	20					NOT NEEDED
	0Z	460-3	DISCONNECT	1	17	20					WMCBC-06C
	09	460-3	DISCONNECT	1	18	20					EHWA042A-C09
	15	460-3	DISCONNECT	1	27	30					EHWA042A-C15
W48AFRC	00	460-3	LUGS	1	12	15					NOT NEEDED
	0Z	460-3	DISCONNECT	1	12	15					WMCBC-06C
	09	460-3	DISCONNECT	1	17	20					EHWA048A-C09
	15	460-3	DISCONNECT	1	26	30					EHWA048A-C15
W60AFRC	00	460-3	LUGS	1	13	15					NOT NEEDED
	0Z	460-3	DISCONNECT	1	13	15					WMCBC-06C
	09	460-3	DISCONNECT	1	18	20					EHWA042A-C09
	15	460-3	DISCONNECT	1	27	30					EHWA042A-C15
W72AFRC	00	460-3	LUGS	1	17	20					NOT NEEDED
	0Z	460-3	DISCONNECT	1	17	20					WMCBC-06C
	09	460-3	DISCONNECT	1	18	20					EHWA042A-C09
	15	460-3	DISCONNECT	1	27	30					EHWA042A-C15

CAUTION: When more than one field power circuit is run through one conduit, the conductors must be de-rated. Pay special attention to Note 8 of Table 310 regarding Ampacity Adjustment Factors when more than three current carrying conductors are in a raceway.

IMPORTANT: While this electrical data is presented as a guide, it is important to electrically connect properly sized fuses and conductor wires in accordance with the National Electrical Code and all local codes. MOCP (Maximum Over-current Protection) value listed is the maximum value as per UL 60335 calculations for MOCP (branch-circuit conductor sizes in this chart are based on this MOCP). The actual factory installed Over-current Protective Device (Circuit Breaker) in this model may be lower than the maximum UL 60335 allowable MOCP value, but still above the UL 60335 minimum calculated value or Minimum Circuit Ampacity (MCA) listed. Refer to the National Electrical code (latest version), Article 310 for power conductor sizing. Review all wiring and safety information provided in the installation manual for the product.

//////// ELECTRIC HEAT KW AND BTUH CHART AT FIELD SUPPLIED VOLTAGE

Electric Heat Nomenclature	Total KW and BTUH @ Field-Supplied Voltage																
	@ 115V			@ 208V				@ 230V				@ 460V			@ 575V		
	KW	1-PH Amps	BTUH	KW	1-PH Amps	3-PH Amps	BTUH	KW	1-PH Amps	3-PH Amps	BTUH	KW	3-PH Amps	BTUH	KW	3-PH Amps	BTUH
02	1.8	16.0	6,300														
03				2.3	10.8		7,700	2.8	12.0		9,400						
04				3.0	14.4		10,200	3.7	16.0		12,600						
05				3.8	18.0	10.4	12,800	4.6	20.0	11.5	15,700	4.6	5.8	15,700			
06				4.5		12.5	15,400	5.5		13.9	18,800	5.5	6.9	18,800	6.0	6.0	20,500
08				6.0	28.8		20,500	7.4	32.0		25,100						
09				6.8		18.7	23,000	8.3		20.8	28,300	8.3	10.4	28,300	9.0	9.0	30,700
10				7.5	36.1		25,600	9.2	40.0		31,400						
12												11.0	13.9	37,700			
15				11.3	54.1	31.2	38,400	13.8	60.0	34.6	47,100	13.8	17.3	47,100	15.0	15.1	51,200
18				13.5		37.5	46,100	16.6		41.6	56,500	16.6	20.8	56,500	18.0	18.1	61,400
20								18.4	80.0		62,800						



////// VENTILATION OPTIONS FOR OUTDOOR AIR INTAKE AND ROOM EXHAUST

	VENT CODE	FIELD INSTALLED KIT PART NUMBER	UNIT MODEL NUMBER	INSTALLED WEIGHT	EXTERNAL FRONT HOOD DEPTH	VENTILATION OPERATION	OCCUPANCY VENTILATION INPUT SIGNAL	VENT AIRFLOW	DAMPER LEAKAGE STANDARD	VENT USE
Barometric Dampers	X	BFAD-1	W12	4.0 (1.8)	No Hood	Barometric	None	Up to 25% of rated intake air. No exhaust.	N/A	The Barometric Intake Damper opens when the indoor fan is operating. Pins provide an easy way to set up the damper assembly.
		FAD-NE2	W18, W24	4.0 (1.8)	No Hood	Barometric	None			
		FAD-NE3	W30, W36	5.0 (2.3)	No Hood	Barometric	None			
		FAD-NE5	W42, W48 W60, W72	13 (5.9)	No Hood	Barometric	None			
	A	FAD-BE2	W18, W24	8.0 (3.6)	No Hood	Barometric	None	Up to 25% of rated intake air with room exhaust.	N/A	This damper provides the same features as the intake version with an added exhaust damper.
		FAD-BE3	W30, W36	9.0 (4.0)	No Hood	Barometric	None			
FAD-BE5		W42, W48 W60, W72	16 (7.3)	No Hood	Barometric	None				
No Vent	B	BOP-1A	W12	1.0 (.5)	No Hood	No Air path	None	None, Air paths are sealed with block off plates.	N/A	The No Vent option provides plates over the intake and exhaust ventilation openings.
		BOP-2	W18, W24	1.0 (.5)	No Hood	No Air path	None			
		BOP-3	W30, W36	1.0 (.5)	No Hood	No Air path	None			
		BOPLATE-5	W42, W48 W60, W72	14 (6.4)	No Hood	No Air path	None			
Commercial Ventilators	M	CRV-F2-*	W18, W24	31.0 (14.0)	No Hood	Motor, Spring Return	24VAC	Up to 50% of rated intake air with room exhaust.	10cfm/ft2	Powered outdoor intake and room exhaust air damper. Opens when 24VAC is applied.
		CRV-F3-*	W30, W36	35.0 (15.9)	No Hood	Motor, Spring Return	24VAC			
		CRV-F5	W42, W48 W60, W72	42 (19.1)	No Hood	Motor, Spring Return	24VAC			
	V	CRVS-1B	W12	31.0 (14.0)	No Hood	Motor, Spring Return	24VAC or 2-10VDC	Up to 50% of rated intake air with room exhaust.	4cfm/ft2	Provides outdoor intake and room exhaust air with improved damper sealing. Opens with either a 24VAC signal or DC voltage is applied.
		CRV-V2-*	W18, W24	31.0 (14.0)	No Hood	Motor, Spring Return	24VAC or 2-10VDC			
		CRV-V3-*	W30, W36	35.0 (15.9)	No Hood	Motor, Spring Return	24VAC or 2-10VDC			
		CRV-V5A	W42, W48 W60, W72	42 (19.1)	No Hood	Motor, Spring Return	24VAC or 2-10VDC			
Free Cooling Economizers	D	ECON-NC2A-*	W18, W24	37.0 (16.8)	7" (17.8cm)	Motor, Spring Return	2-10VDC	Full rated intake air with room exhaust.	4cfm/ft2	Economizer assembly with damper motor. Field supplied controls needed for operation.
		ECON-NC3A-*	W30, W36	37.0 (16.8)	7" (17.8cm)	Motor, Spring Return	2-10VDC			
		ECON-NC5A	W42, W48 W60, W72	44 (20)	No Hood	Motor, Spring Return	2-10VDC			
	E	JIFM-1B	W12	37.0 (16.8)	No Hood	Motor, Spring Return	24VAC or 0-10VDC	Up to 75% of rated intake air with room exhaust.	4cfm/ft2	Economizer with JADE controller. User defined economizing based on enthalpy curves.
	S	ECON-S2-*	W18, W24	37.0 (16.8)	No Hood	Motor, Spring Return	24VAC or 0-10VDC			
		ECON-S3-*	W30, W36	37.0 (16.8)	No Hood	Motor, Spring Return	24VAC or 0-10VDC			
	Y	ECON-DB2A-*	W42, W48 W60, W72	37.0 (16.8)	7" (17.8cm)	Motor, Spring Return	24VAC or 0-10VDC	Full rated intake air with room exhaust.	4cfm/ft2	Economizer with JADE controller. User defined economizing based on dry bulb temperature.
		ECON-DB3A-*	W30, W36	37.0 (16.8)	7" (17.8cm)	Motor, Spring Return	24VAC or 0-10VDC			
		ECON-DB5A	W42, W48 W60, W72	44 (20)	No Hood	Motor, Spring Return	24VAC or 0-10VDC			
	Z	ECON-WD2A-*	W18, W24	37.0 (16.8)	7" (17.8cm)	Motor, Spring Return	24VAC or 0-10VDC	Full rated intake air with room exhaust.	4cfm/ft2	Economizer with JADE controller. User defined economizing based on enthalpy curves.
		ECON-WD3A-*	W30, W36	37.0 (16.8)	7" (17.8cm)	Motor, Spring Return	24VAC or 0-10VDC			
		ECON-WD5A	W42, W48 W60, W72	44 (20)	No Hood	Motor, Spring Return	24VAC or 0-10VDC			
Energy Recovery Vents	R (230V Units)	ERV-FA2-*	W18, W24	54.0 (24.4)	4" (10.2cm)	208/230V Unit Blowers	24VAC - 3 speeds	Up to 200cfm	N/A	Energy Recovery Ventilator with independently adjustable intake and exhaust fans. Heat exchange wheel used to transfer heat from outdoor intake and room exhaust air paths.
		ERV-FA3-*	W30, W36	54.0 (24.4)	4" (10.2cm)	208/230V Unit Blowers	24VAC - 3 speeds	Up to 400cfm		
		ERV-FA5	W42, W48 W60, W72	87 (39.5)	No Hood	208/230V Unit Blowers	24VAC - 3 speeds	Up to 450cfm		
	R (460V Units)	ERV-FC2-*	W24	54.0 (24.4)	4" (10.2cm)	460V Unit Blowers	24VAC - 3 speeds	Up to 200cfm		
		ERV-FC3-*	W30, W36	54.0 (24.4)	4" (10.2cm)	460V Unit Blowers	24VAC - 3 speeds	Up to 400cfm		
		ERV-FC5	W42, W48 W60, W72	87 (39.5)	No Hood	460V Unit Blowers	24VAC - 3 speeds	Up to 450cfm		



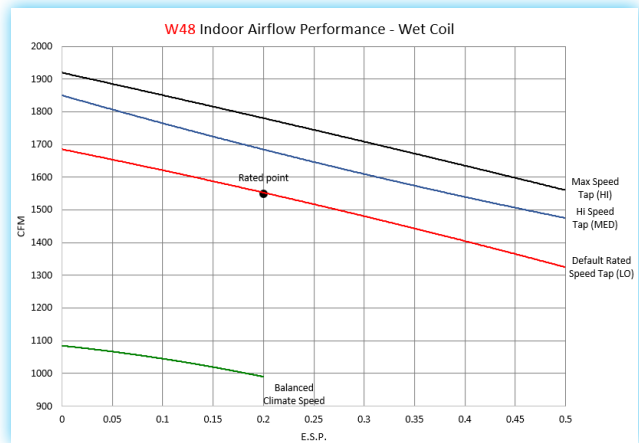
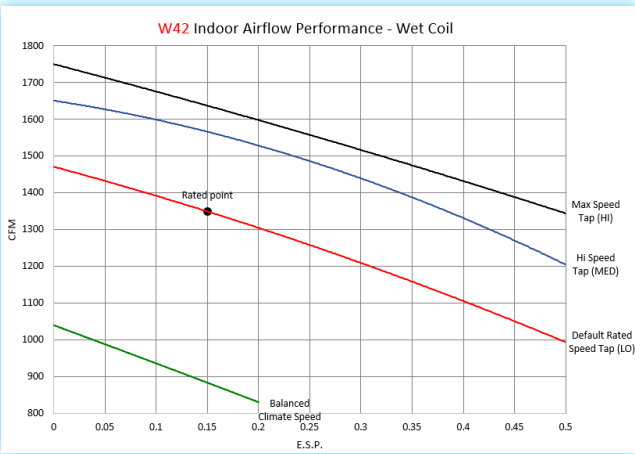
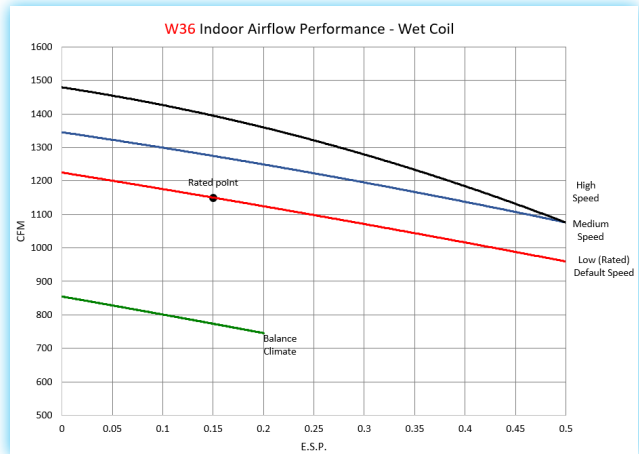
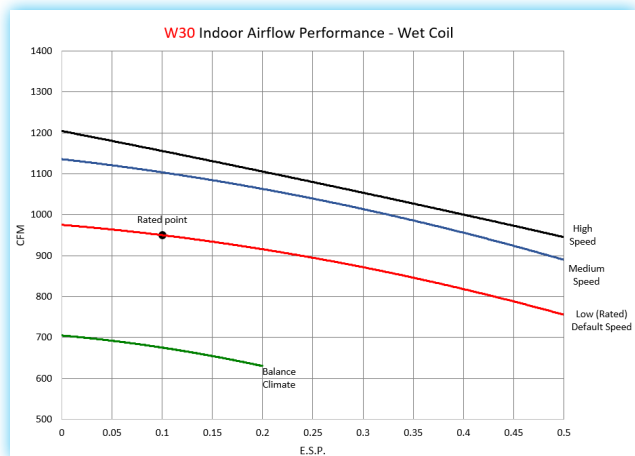
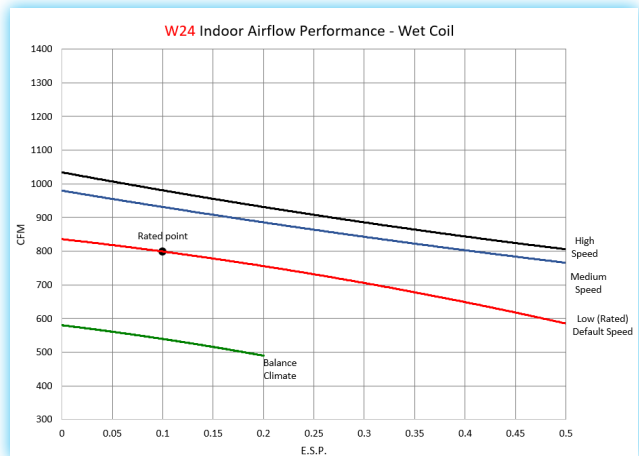
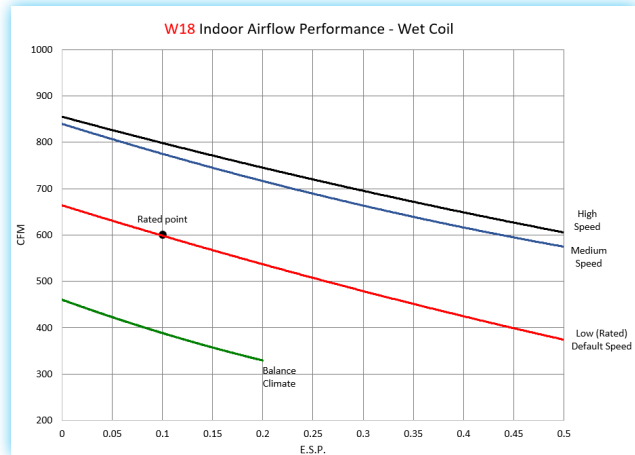
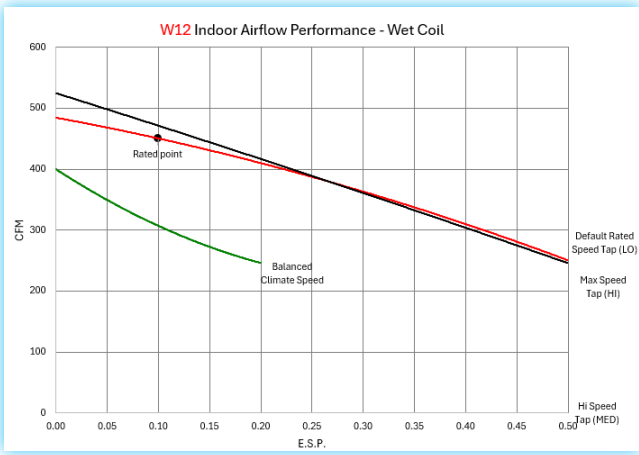

Indoor Airflow Speeds:

Balanced Climate Speed: The WA series uses this speed when the **Balanced Climate option (Y1)** or **mechanical dehumidification option (D)** is used. Not recommended for static levels higher than that Balanced Climate airflow data provided.

LO Speed (Default): The WA series uses this speed by default when using **standard cooling (Y2)** or **heating operation (W1/W2)**. This speed is labeled as LO on the speed selection terminal strip inside the unit control panel. The WA series also uses this speed when **fan only (G)** or **ventilation operation (A)** is used. All units ship with cooling and heating operation at LO cooling and heating speed, and provides the **optimal airflow amount for normal use**.

MED Speed (User Selectable): This speed is user selectable when using **standard cooling (Y2)** or **heating operation (W1/W2)**. This speed is labeled as MED on the speed selection terminal strip inside the unit control panel. The MED speed tap provides an **increase in unit airflow** per the airflow performance chart. Fan only and dehumidification fan operation is not effected by using MED speed.

HI Speed (User Selectable): This speed is user selectable when using **standard cooling (Y2)** or **heating operation (W1/W2)**. This speed is labeled as HI on the speed selection terminal strip inside the unit control panel. The HI speed tap provides **maximum unit airflow** per the airflow performance chart. Fan only and dehumidification fan operation is not effected by using HI speed.



INDOOR AIRFLOW CFM @ STATIC PRESSURES AND ADJUSTABLE SPEEDS - W60 AND W72 UNITS

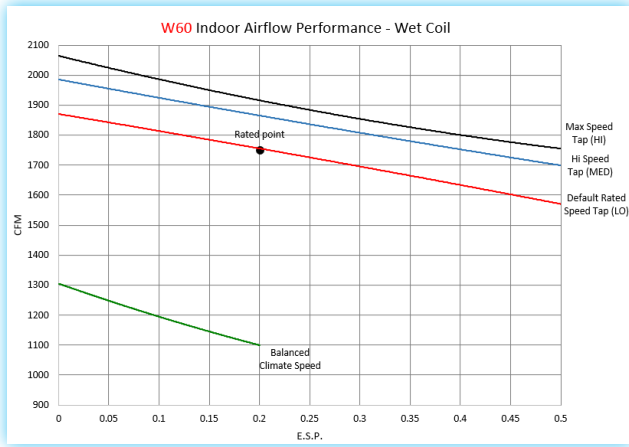

Indoor Airflow Speeds:

Balanced Climate Speed: The WA series uses this speed when the **Balanced Climate option (Y1)** or **mechanical dehumidification option (D)** is used. Not recommended for static levels higher than Balanced Climate airflow data provided.

LO Speed (Default): The WA series uses this speed by default when using **standard cooling (Y2)** or **heating operation (W1/W2)**. This speed is labeled as LO on the speed selection terminal strip inside the unit control panel. The WA series also uses this speed when **fan only (G)** or **ventilation operation (A)** is used. All units ship with cooling and heating operation at LO cooling and heating speed, and provides the **optimal airflow amount for normal use**.

MED Speed (User Selectable): This speed is user selectable when using **standard cooling (Y2)** or **heating operation (W1/W2)**. This speed is labeled as MED on the speed selection terminal strip inside the unit control panel. The MED speed tap provides an **increase in unit airflow** per the airflow performance chart. Fan only and dehumidification fan operation is not effected by using MED speed.

HI Speed (User Selectable): This speed is user selectable when using **standard cooling (Y2)** or **heating operation (W1/W2)**. This speed is labeled as HI on the speed selection terminal strip inside the unit control panel. The HI speed tap provides **maximum unit airflow** per the airflow performance chart. Fan only and dehumidification fan operation is not effected by using HI speed.

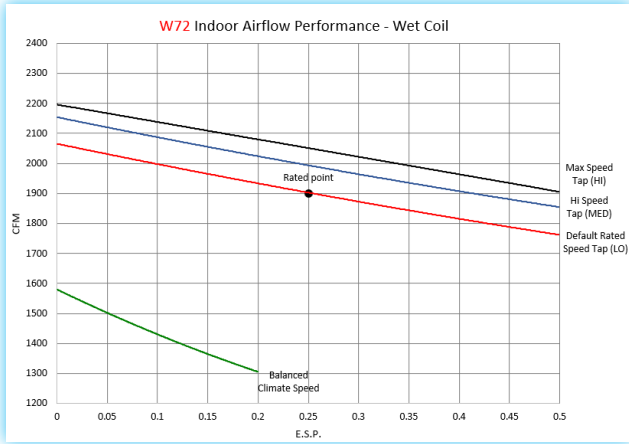

INDOOR AIRSTREAM FILTRATION OPTIONS

UNIT MODEL	FILTER CODE	FILTER MERV RATING	NUMBER OF FILTERS USED	BARD PART NUMBER	FILTER SIZE INCHES (CM)	FILTER ESP	FILTRATION LEVEL
W12	X	MERV 2	1	7004-056	12x24x1 (30x61x3)	0" WC	Low Filtration, 1" Thickness Disposable Media.
	W	MERV 2	1	7003-073	12x24x1 (30x61x3)	0" WC	Low Filtration, 1" Thickness Cleanable Media.
	P	MERV 8	1	7004-057	12x24x2 (30x61x6)	.03" WC	Average Filtration, 2" Thickness Pleated Disposable Media.
	N	MERV 13	1	7004-072	12x24x2 (30x61x6)	.08" WC	High Filtration, 2" Thickness Pleated Disposable Media.
W18, W24	X	MERV 2	1	7004-011	16x25x1 (41x64x3)	0" WC	Low Filtration, 1" Thickness Disposable Media.
	W	MERV 2	1	7003-032	16x25x1 (41x64x3)	0" WC	Low Filtration, 1" Thickness Cleanable Media.
	P, C	MERV 8	1	7004-025	16x25x2 (41x64x6)	.03" WC	Average Filtration, 2" Thickness Pleated Disposable Media.
	M	MERV 11	1	7004-059	16x25x2 (41x64x6)	.05" WC	Above Average Filtration, 2" Thickness Pleated Disposable Media.
	A, B, N	MERV 13	1	7004-061	16x25x2 (41x64x6)	.08" WC	High Filtration, 2" Thickness Pleated Disposable Media.
W30, W36	X	MERV 2	1	7004-019	16x30x1 (41x77x3)	0" WC	Low Filtration, 1" Thickness Disposable Media.
	W	MERV 2	1	7003-031	16x30x1 (41x77x3)	0" WC	Low Filtration, 1" Thickness Cleanable Media.
	P	MERV 8	1	7004-026	16x30x2 (41x77x6)	.03" WC	Average Filtration, 2" Thickness Pleated Disposable Media.
	M	MERV 11	1	7004-048	16x30x2 (41x77x6)	.05" WC	Above Average Filtration, 2" Thickness Pleated Disposable Media.
	A, B, N	MERV 13	1	7004-062	16x30x2 (41x77x6)	.08" WC	High Filtration, 2" Thickness Pleated Disposable Media.
W42, W48, W60, W72	X	MERV 2	2	7004-012	20x20x1 (51x51x3)	0" WC	Low Filtration, 1" Thickness Disposable Media.
	W	MERV 2	2	7003-085	20x20x1 (51x51x3)	0" WC	Low Filtration, 1" Thickness Cleanable Media.
	P, C	MERV 8	2	7004-052	20x20x2 (51x51x6)	.03" WC	Average Filtration, 2" Thickness Pleated Disposable Media.
	M	MERV 11	2	7004-060	20x20x2 (51x51x6)	.05" WC	Above Average Filtration, 2" Thickness Pleated Disposable Media.
	A, B, N	MERV 13	2	7004-063	20x20x2 (51x51x6)	.08" WC	High Filtration, 2" Thickness Pleated Disposable Media.



////// CABINET COLOR AND FINISH OPTIONS

UNIT MODEL	CABINET COLOR AND FINISH CODE	COLOR AND FINISH	Description
All Units	X	Beige Painted Steel	This cabinet option uses zinc coated steel panels that are cleaned, rinsed, sealed and dried before a polyurethane primer is applied. The cabinet paint coating is comprised of a textured enamel. The resulting finish is designed to withstand over 1000 hours of salt spray tests per ASTM B117-03. . Unit top, structural sides, and front service panels are constructed using 20 gauge materials. The unit base is constructed using 16 gauge galvanized steel. Cabinet components are insulated with a non-fiberglass formaldehyde free insulation that has a high "R" value, is easy to clean with a FSK foil backing, and resists delamination.
	1	White Painted Steel	
	4	Buckeye Gray Painted Steel	
	5	Desert Brown Painted Steel	
	8	Dark Bronze Painted Steel	
W18, W24, W30, W36, W42, W48, W60, W72	S	Stainless Steel	Exterior Stainless Steel finish cabinets are often selected for corrosion and chemical resistance. The Bard stainless steel unit offers a high quality stainless steel 316 grade enclosure and fasteners for years of operation in these conditions. The exterior cabinet, sheet metal screws, washers, nuts, compressor mounting hardware and outdoor fan motor mount are stainless steel. The condenser fan is corrosion coated for additional protection.
W18, W24, W30, W36, W42, W48, W60, W72	A	Aluminum	Aluminum external cabinet finish option "A" units are constructed of ASTM B 209 grade .06" thickness panels with a stucco appearance.



X—Beige

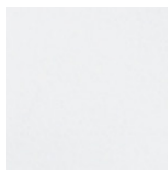

1—White



4—Gray



5—Desert

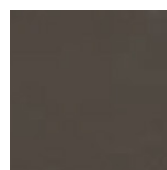

8—Bronze



S—Stainless



A—Aluminum

////// ADDITIONAL CORROSION COATED EVAPORATOR COIL, CONDENSER COIL, AND CABINET OPTIONS

UNIT MODEL	COIL AND CABINET COATING OPTION	EVAPORATOR COIL	CONDENSER COIL	INTERIOR CONDENSER SECTION	EXTERIOR AND INTERIOR CABINET	DESCRIPTION
All Units	X	STANDARD	STANDARD	STANDARD	STANDARD	Standard green fin evaporator coil and copper aluminum condenser coil. Cabinet is not coated.
	1	COATED	STANDARD	STANDARD	STANDARD	Corrosion coated evaporator coil and copper aluminum condenser coil. Cabinet is not coated.
	2	STANDARD	COATED	STANDARD	STANDARD	Standard green fin evaporator coil and corrosion coated condenser coil. Cabinet is not coated.
	3	COATED	COATED	STANDARD	STANDARD	Evaporator coil and condenser coil are both corrosion coated. Cabinet is not coated.
W18, W24, W30, W36, W42, W48, W60, W72	4	COATED	COATED	COATED	STANDARD	Evaporator coil and condenser coil are both corrosion coated. Cabinet interior condenser section is coated.
W18, W24, W30, W36, W42, W48, W60, W72	5	COATED	COATED	COATED	COATED	Evaporator coil and condenser coil are both corrosion coated. Cabinet interior and exterior is coated.



///// FACTORY CONTROLS OPTIONS CHART INCLUDING SWITCHES, SENSORS, RELAYS, AND START KITS

Factory installed controls are provided by Bard to enhance a Wall-Mount product before it is shipped. All Wall-Mount products are shipped with a auto-reset high pressure switch and an auto-reset low pressure switch to help protect refrigeration components. A compressor control module with adjustable voltage protection, delay on make and break, and high/low pressure diagnostics is also standard

CONTROL CODE	MODELS	DESCRIPTION OF FACTORY INSTALLED COMPONENTS
X	ALL MODELS	Standard Hi Pressure Switch, Low Pressure Switch, Compressor Control Module, and Refrigerant leak detector (RDS). These controls are standard for all models.
E	ALL MODELS	Standard controls and Low Ambient Control.
F	W18AF-W72AF W42AFD-W72AFD	Standard controls, Low Ambient Control and Dirty Filter Pressure Switch.
J	W12AF-W72AF W30AFD-W72AFD	Standard controls, Low Ambient Control and Refrigerant Pressure Alarm Relay with NO/NC Contacts.
M	W18AF-W72AF W42AFD-W72AFD	Standard controls, Low Ambient Control, Alarm Relay, and PTCR Start Kit. 208V/230V single phase units only.
V	W18AF-W72AF W42AFD-W72AFD	Standard controls, Low Ambient Control, Alarm Relay, Discharge temperature sensor, Indoor Blower Airflow Press. Switch, Compressor Current Sensor, Dirty Filter Pressure Switch.

///// FIELD KIT CONTROLS OPTIONS CHART INCLUDING SWITCHES, SENSORS, RELAYS, AND START KITS

Field installed kits provide accessories that can be installed in the field. Required components, wires, enclosures, screws, and instructions that are needed are provided within the kit.

KIT PART NO.	UNITS USING KIT	DESCRIPTION OF FIELD INSTALLED KIT
CMA-37 = 230V	W18A, W18L, W24A, W24L	Low Ambient Control allows compressor cooling between 0°F and 50°F outdoor temp. - modulating
CMA-38 = 460V	W18A, W18L, W24A, W24L	Low Ambient Control allows compressor cooling between 0°F and 50°F outdoor temp. - modulating
CMA-41	W30A, W30L, W36A, W36L	Low Ambient Control allows compressor cooling between 0°F and 50°F outdoor temp. - fan cycling
CMA-39	W12A, W42A, W48A, W60A, W72A	Low Ambient Control allows compressor cooling between 0°F and 50°F outdoor temp. - fan cycling
CMC-15	W18A, W18L, W24A, W24L, W30A, W30L, W36A, W36L	PTCR Start Kit. Increases starting torque by 2 to 3x. 230V-60hz-1 phase (A voltage) only. Cannot be used in combination with SK start kit
CMC-32	W42A, W48A, W60A, W72A	PTCR Start Kit. Increases starting torque by 2 to 3x. 230V-60hz-1 phase (A voltage) only. Cannot be used in combination with SK start kit
SK111	W18A, W18L, W24A, W24L, W30A, W30L, W36A, W36L	Start Capacitor and Potential Relay Start Kit. Increases starting torque by 9x. 230V-60hz-1 phase (A voltage) only. Cannot be used in combination with CMC start kit
CMA-14	W18A, W18L, W24A, W24L, W30A, W30L, W36A, W36L	Outdoor Thermostat Kit used to disable compressor cooling below 50°F outdoor temp. Adjustable between 50° and 0°F
CMA-43	W42A, W48A, W60A, W72A	Outdoor Thermostat Kit used to disable compressor cooling below 50°F outdoor temp. Adjustable between 50° and 0°F
CMC-34	W18A, W18L, W24A, W24L, W30A, W30L, W36A, W36L	Compressor Control Module Lockout Alarm Relay Kit.
CMC-35	W42A, W48A, W60A, W72A	Compressor Control Module Lockout Alarm Relay Kit.
CMC-36	W18A, W18L, W24A, W24L, W30A, W30L, W36A, W36L	Crank case heater kit. 230V 1-PH units only
CMC-40	W18A, W18L, W24A, W24L, W30A, W30L, W36A, W36L	Crank case heater kit. 230V 3-PH units only
CMC-37	W18A, W18L, W24A, W24L, W30A, W30L, W36A, W36L	Crank case heater kit. 460V 3-PH units only
CMC-38	W42A, W48A, W60A, W72A	Crank case heater kit. 230V 1-PH units only
CMC-41	W42A, W48A, W60A, W72A	Crank case heater kit. 230V 3-PH units only
CMC-39	W42A, W48A, W60A, W72A	Crank case heater kit. 460V 3-PH units only



FIELD INSTALLED AIR QUALITY KITS

Field installed kits provide accessories that can be installed in the field. Required components, wires, enclosures, screws, and instructions that are needed are provided within the kit.

CONTROL CODE	KIT PART NO.	UNITS USING KIT	DESCRIPTION OF FIELD INSTALLED KIT
NA	CMC-31	W18A, W18L, W24A, W24L, W30A, W30L, W36A, W36L	Dirty Filter Alarm Pressure Sensor Kit. Provides Normally Open Contacts to send an alarm signal to a thermostat or controller.
NA	CMC-33	W42A, W48A, W60A, W72A	Dirty Filter Alarm Pressure Sensor Kit. Provides Normally Open Contacts to send an alarm signal to a thermostat or controller.
NA	8620-343	W18A, W18L, W24A, W24L, W30A, W30L, W36A, W36L, W42A, W48A, W60A, W72A	LED UV-C Long Life Light Kit. 460V units only. Installed in evaporator coil entering airstream along with door safety switch. Indicator light provided to monitor LED use.
NA	8620-344	W18A, W18L, W24A, W24L, W30A, W30L, W36A, W36L, W42A, W48A, W60A, W72A	LED UV-C Long Life Light Kit. 230V units only. Installed in evaporator coil entering airstream along with door safety switch. Indicator light provided to monitor LED use.
NA	8620-370	W18A, W18L, W24A, W24L, W30A, W30L, W36A, W36L, W42A, W48A, W60A, W72A	NBPI (AIR4) kit installed in evaporator area. The kit includes wires and mounting hardware needed to install the NBPI device on or near the indoor fan.

ADVANCED SENSOR OPTIONS AND KITS

Field installed kits provide accessories that can be installed in the field. Required components, wires, enclosures, screws, and instructions that are needed are provided within the kit.

CONTROL CODE	KIT PART NO.	UNITS USING KIT	DESCRIPTION OF FIELD INSTALLED KIT
V	CMA-40	W18A, W18L, W24A, W24L, W30A, W30L, W36A, W36L	Kit Includes Discharge temperature sensor, Indoor Blower Airflow Press. Switch, Compressor Current Sensor, Dirty Filter Alarm Pressure Sensor.
V	CMA-44	W42A, W48A, W60A, W72A	Kit Includes Discharge temperature sensor, Indoor Blower Airflow Press. Switch, Compressor Current Sensor, Dirty Filter Alarm Pressure Sensor.
NA	8620-340	W18A, W18L, W24A, W24L, W30A, W30L, W36A, W36L	Return Air Sensor Kit for use with all economizers with the JADE controller.
NA	8620-334	W42A, W48A, W60A, W72A	Return Air Sensor Kit for use with all economizers with the JADE controller.

* CMA-40 and CMA-44 kit does not include low ambient control (sold separately).

SOUND REDUCTION ACCESSORIES

Field installed kits provide accessories that can be installed in the field. Required components, wires, enclosures, screws, and instructions that are needed are provided within the kit.

CONTROL CODE	KIT PART NO.	UNITS USING KIT	DESCRIPTION OF FIELD INSTALLED KIT
NA	8620-331	W60A, W72A	Kit Includes Outdoor Fan Speed Control Board and outdoor fan motor components and wire harnesses along with outdoor temperature sensor. Compressor sound cover is included.
NA	8002-012	W18A, W18L, W24A, W24L, W30A, W30L, W36A, W36L	Compressor sound cover. Weatherized vinyl insulated cover that helps reduce compressor sound level.
NA	8002-013	W42A, W48A, W60A, W72A	Compressor sound cover. Weatherized vinyl insulated cover that helps reduce compressor sound level.

OPTIONAL SHIPPING CRATES

Optional crates are available to help protect your valuable Wall-Mount investment during shipping. Constructed from OSB sheathing with steel corner posts, and sized for standard truck transportation. Treated for pests in accordance with the International Plant Protection Convention, Publication 15, Annex 1. Packaging is acceptable for international shipments.

CRATE NO.	UNIT MODELS	DESCRIPTION
8620-263	W18A, W18L, W24A, W24L	Standard Unit Crate, all vents except economizer.
8620-275	W18A, W18L, W24A, W24L	Units with Economizer vent (Factory Installed 7" Hood).
8620-262	W30A, W30L, W36A, W36L	Standard Unit Crate, all vents except economizer
8620-276	W30A, W30L, W36A, W36L	Units with Economizer vent (Factory Installed 7" Hood).
8620-304	W42A, W48A	Standard Unit Crate, all ventilation options
8620-305	W60A, W72A	Standard Unit Crate, all ventilation options



////// WALL CURB ACCESSORIES

Optional wall curb accessories are available to help reduce vibration through the outer wall surface or to use existing wall openings when replacing equipment. Follow all static pressure airflow requirements, safety and installation guidelines in the instructions provided with the curb and Wall-Mount products.

CURB	UNITS USING CURB	DESCRIPTION
WWC2-*	W18A, W18L, W24A, W24L	Install to use with existing 1, 2 or 3 ton wall openings. Wall openings must provide sufficient airflow. Follow all instructions in curb and unit manual including clearances to combustibles and maximum duct static pressure.
WWC3-*	W30A, W30L, W36A, W36L	Install to use with existing 2, 3, or 5 ton wall openings. Wall openings must provide sufficient airflow. Follow all instructions in curb and unit manual including clearances to combustibles and maximum duct static pressure.
WWC5-*	W42A, W48A, W60A, W72A	Install to use with existing 3 and 5 ton wall openings. Wall openings must provide sufficient airflow. Follow all instructions in curb and unit manual including clearances to combustibles and maximum duct static pressure.

* Color Option

////// NON-DUCTED SUPPLY AND RETURN GRILLES

Supply and return louver grilles are of a brushed aluminum finish. 2" flange versions are recommended for standard installations to allow grille attachment when large wall openings are present. Return filter grilles are available for filter access from an indoor area. Filter grilles do not include a filter, and are not recommended for unit with ventilation due to filter location. A manual damper return grille is available for W42 and W72 models. The manual damper is adjustable, and is only recommended for installations where increased return duct static pressure is required.

GRILLE NO.	UNITS USING GRILLE	DESCRIPTION OF LOUVER GRILLE
SG-2	W18A, W18L, W24A, W24L	8" x 20" with 1" Flange 4 way deflection supply grille.
SG-3	W30A, W30L, W36A, W36L	8" x 28" with 1" Flange 4 way deflection supply grille.
SG-5	W42A, W48A, W60A, W72A	10" x 30" with 1" Flange 4 way deflection supply grille.
RG-2	W18A, W18L, W24A, W24L	12" x 20" with 1" Flange return grille.
RG-3	W30A, W30L, W36A, W36L	12" x 28" with 1" Flange return grille.
RG-5	W42A, W48A, W60A, W72A	16" x 30" with 1" Flange return grille.
SG-2W	W18A, W18L, W24A, W24L	8" x 20" with 2" Flange 4 way deflection supply grille.
SG-3W	W30A, W30L, W36A, W36L	8" x 28" with 2" Flange 4 way deflection supply grille.
SG-5W	W42A, W48A, W60A, W72A	10" x 30" with 2" Flange 4 way deflection supply grille.
RG-2W	W18A, W18L, W24A, W24L	12" x 20" with 2" Flange return grille.
RG-3W	W30A, W30L, W36A, W36L	12" x 28" with 2" Flange return grille.
RG-5W	W42A, W48A, W60A, W72A	16" x 30" with 2" Flange return grille.
RFG-2W	W18A, W18L, W24A, W24L	12" x 20" with 2" Flange return grille with filter bracket.*
RFG-3W	W30A, W30L, W36A, W36L	12" x 28" with 2" Flange return grille with filter bracket.*
RFG-5W	W42A, W48A, W60A, W72A	16" x 30" with 2" Flange return grille with filter bracket.*
RGDK-2W	W18A, W24A, W24L	12" x 20" with 2" manual shutter style damper that is mounted in the return duct behind the return grille (sold separately). Adjustable to restrict return air from room.
RGDK-3W	W30A, W30L, W36A, W36L	12" x 28" with 2" manual shutter style damper that is mounted in the return duct behind the return grille (sold separately). Adjustable to restrict return air from room.
RGDK-5W	W42A, W48A, W60A, W72A	16" x 30" manual shutter style damper that is mounted in the return duct behind the return grille (sold separately). Adjustable to restrict return air from room.

* Not recommended to provide primary filtration with units that will bring in outdoor air.



CONTROLLER, THERMOSTAT, HUMIDISTAT AND CO2 VENTILATION CONTROL OPTIONS

Bard provides a wide variety of controllers for equipment cooling, thermostats, for equipment and comfort cooling, humidistats for dehumidification units, and CO2 sensors for ventilation control. Lockable thermostat covers are available for applications where security or supervisory control is desired.

CONTROLLER	OPERATION	DESCRIPTION
MC4002	1 to 2 Unit Lead/Lag Controller	Standard unit Lead/Lag Controller with remote alarming capability. Optional alarm board and SNMP or web page communication board. On board temperature sensor that can be remote mounted. Can use up to (2) remote temperature sensors.
MC5300	1 to 3 Unit Lead/Lag Controller	Advanced multi-unit Lead/Lag Controller with remote alarming capability. All models have Modbus communication and web pages. Optional alarm board with NO/NC contacts. On board temperature and humidity sensor that can be remote mounted. Can use up to (2) remote temperature sensors.
MC5600	1 to 6 Unit Lead Lag Controller	Advanced multi-unit Lead/Lag Controller with remote alarming capability. All models have Modbus communication and web pages. Optional alarm board with NO/NC contacts. On board temperature and humidity sensor that can be remote mounted. Can use up to (2) remote temperature sensors.

THERMOSTAT	OPERATION	DESCRIPTION
8403-060	3 Heat/3 Cool	Programmable or Nonprogrammable, ventilation output, dehumidification operation
8403-089	1 Heat/1 Cool	Temp. Settings per Day 4, 2, 1, 0 Programs per Week 7, 5-2, 5-1-1 or Nonprogrammable
8403-090	2 Heat/2 Cool	Temp. Settings per Day 4, 2, 1, 0 Programs per Week 7, 5-2, 5-1-1 or Nonprogrammable
8403-091	1 Heat/1 Cool	Easy to use, Nonprogrammable. FEMA use
8403-092	2 Heat/2 Cool	Programmable or Nonprogrammable, ventilation output, Wi-Fi
8403-095	2 Heat/1 Cool	Temp. Settings per Day 4, 2, 1, 0 Programs per Week 7, 5-2, 5-1-1 or Nonprogrammable

HUMIDISTAT	OPERATION	DESCRIPTION
8403-047	Humidity %RH	Electronic with display, lockable keypad, humidity sensor calibration (Viconics)
8403-100	Humidity %RH	Electronic with display, lockable keypad, humidity sensor calibration (Honeywell)

CO2 CONTROL	OPERATION	DESCRIPTION
S8403-096	CO2 PPM	CO2 ventilation control with digital display. On/Off or modulating ventilation operation

THERMOSTAT COVER*	SIZE	DESCRIPTION
8405-003	(Inside) 5-1/16" H x 6-1/16" W (Outside) 6-1/2" H x 7-1/2" W x 2-15/16" D	Clear acrylic with ventilation. Fits all thermostats except 8403-060
8405-005	(Inside) 5-7/8" H x 8-3/8" W (Outside) 7-1/4" H x 9-3/4" W x 3-3/8" D	Clear acrylic with ventilation. Fits all thermostats.
8405-006	(Inside) 5-1/16" H x 6-1/16" W (Outside) 6-3/8" H x 7-3/8" W x 2-7/8" D	Clear acrylic with ventilation. Fits all thermostats except 8403-060
8405-007	(Inside) 5-7/8" H x 8-3/8" W (Outside) 7-1/8" H x 9-5/8" W x 3-1/4" D	Beige painted steel cover with ventilation. Fits all thermostats.

* Thermostat covers include ventilation, but may effect temperature control reaction time. If security control lockout is needed, the 8403-060 thermostat provides input control lockout features.



Bard Manufacturing Company, Inc.
1914 Randolph Dr., Bryan, OH 43506
419-636-1194

www.bardhvac.com

Due to our continuous product improvement policy,
all specifications subject to change without notice.

