

230/208-60-3  
240/220-50-3

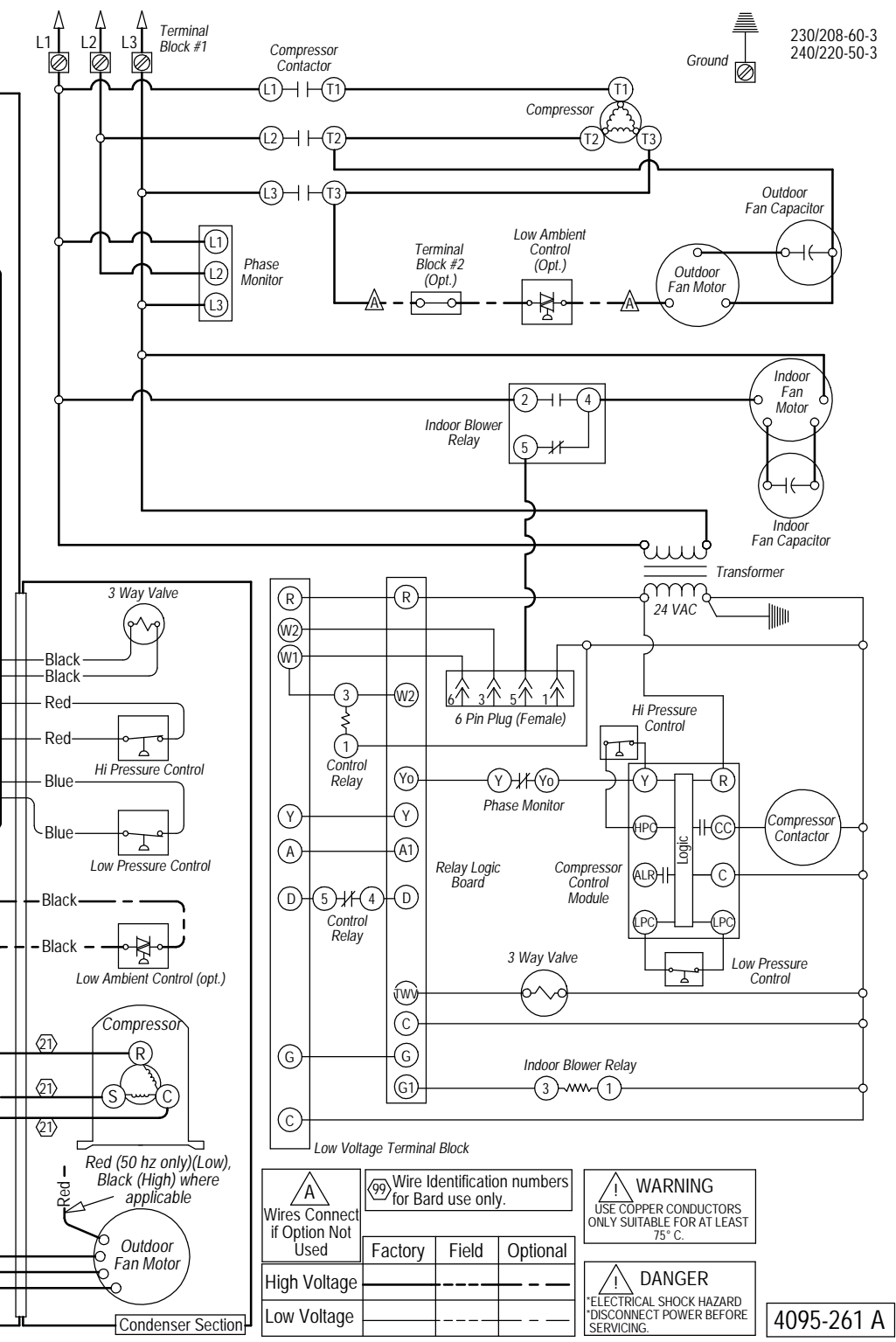
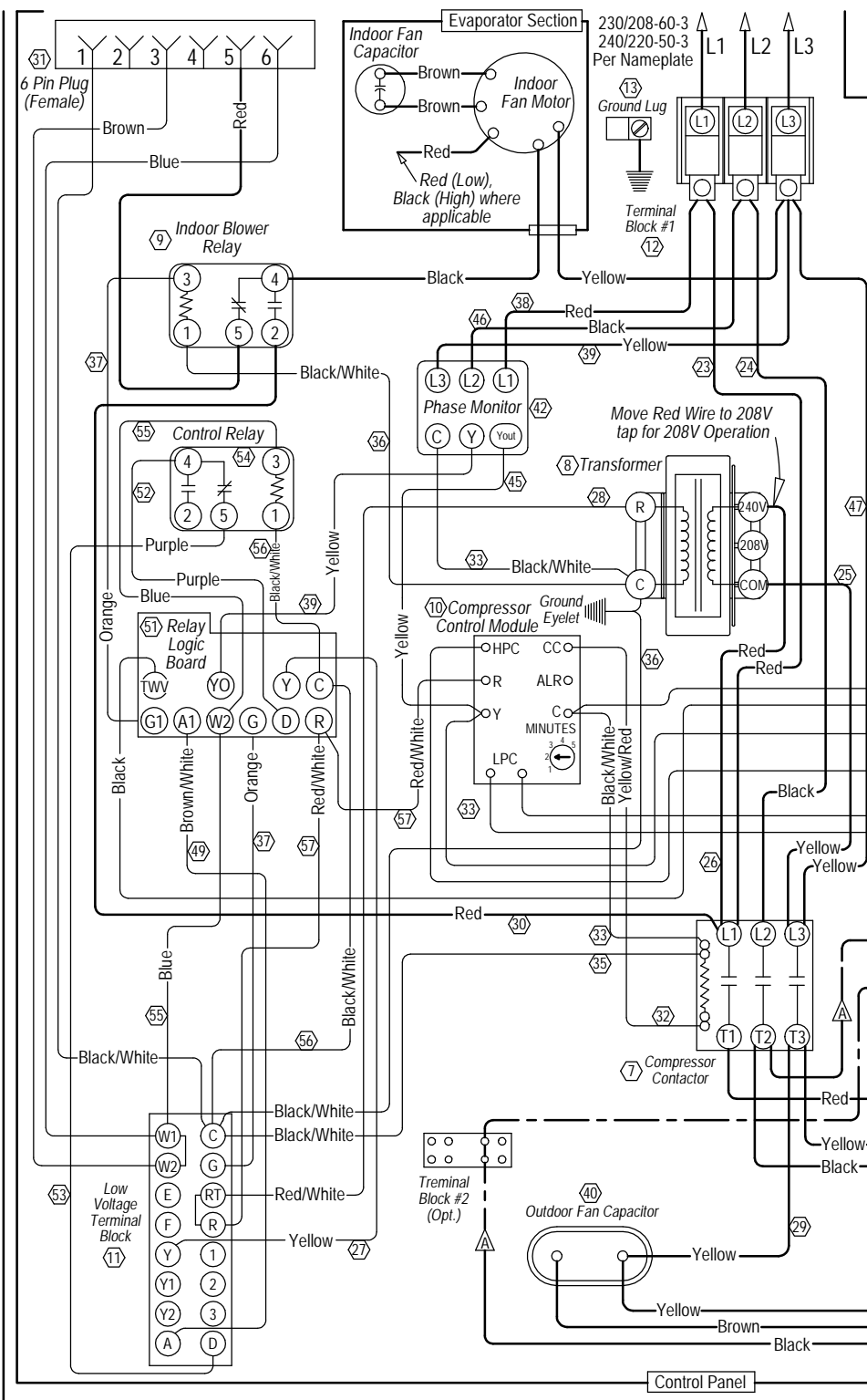

<p><b>A</b></p> <p>Wires Connect if Option Not Used</p>	<p><b>99</b> Wire Identification numbers for Bard use only.</p>		
	Factory	Field	Optional
High Voltage			
Low Voltage			

**WARNING**  
USE COPPER CONDUCTORS  
ONLY SUITABLE FOR AT LEAST  
75° C.

**DANGER**  
ELECTRICAL SHOCK HAZARD  
DISCONNECT POWER BEFORE  
SERVICING.

4095-261 A