

For Vent Wiring or controller/thermostat connections, see literature packet or go to www.bardhvac.com

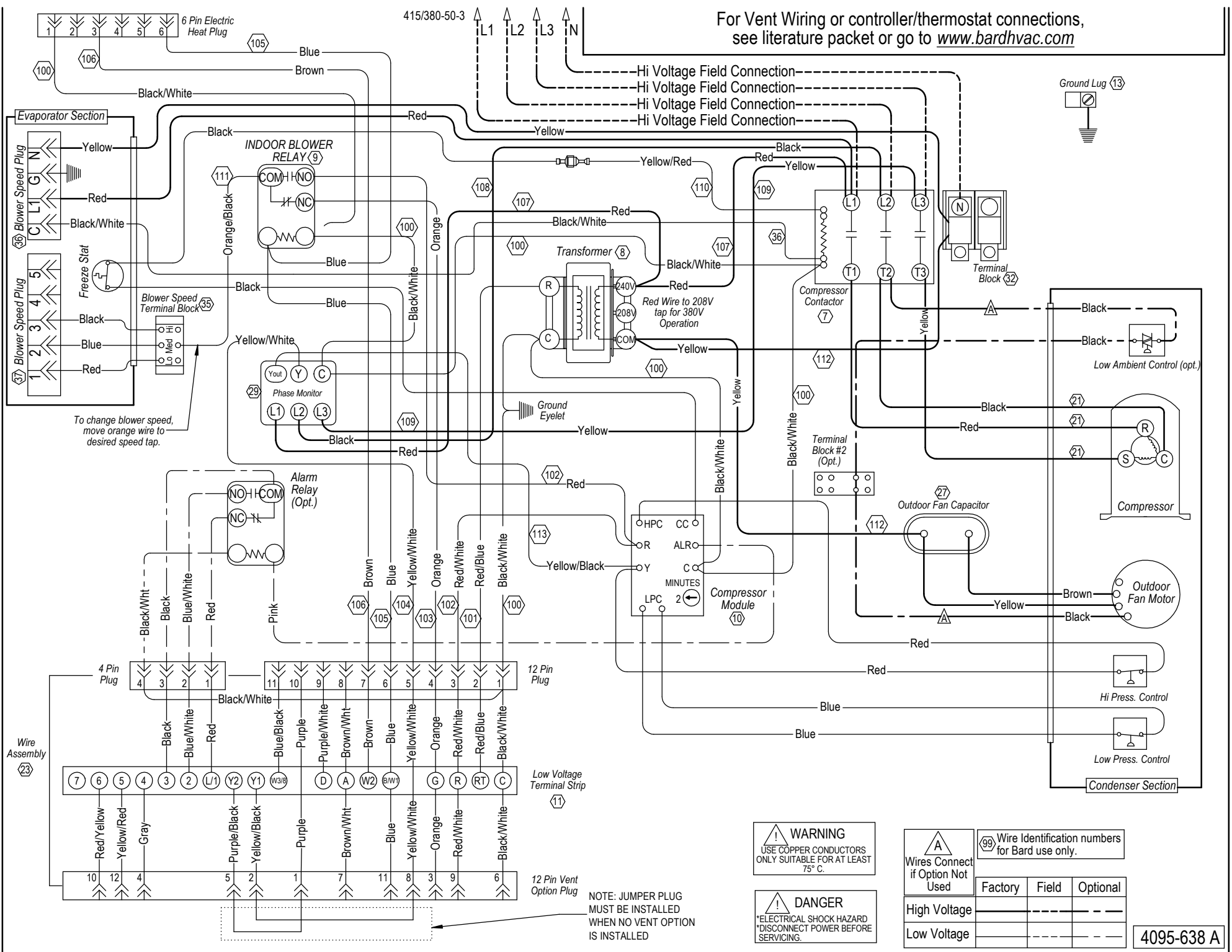

To change blower speed, move orange wire to desired speed tap.

NOTE: JUMPER PLUG MUST BE INSTALLED WHEN NO VENT OPTION IS INSTALLED

WARNING
USE COPPER CONDUCTORS ONLY SUITABLE FOR AT LEAST 75° C.

DANGER
ELECTRICAL SHOCK HAZARD DISCONNECT POWER BEFORE SERVICING.

A
Wires Connect if Option Not Used

99 Wire Identification numbers for Bard use only.

	Factory	Field	Optional
High Voltage			
Low Voltage			

4095-638 A