

USE COPPER CONDUCTORS
ONLY SUITABLE FOR
AT LEAST 75° C

PART # 4097-162 D

230/208-60-1

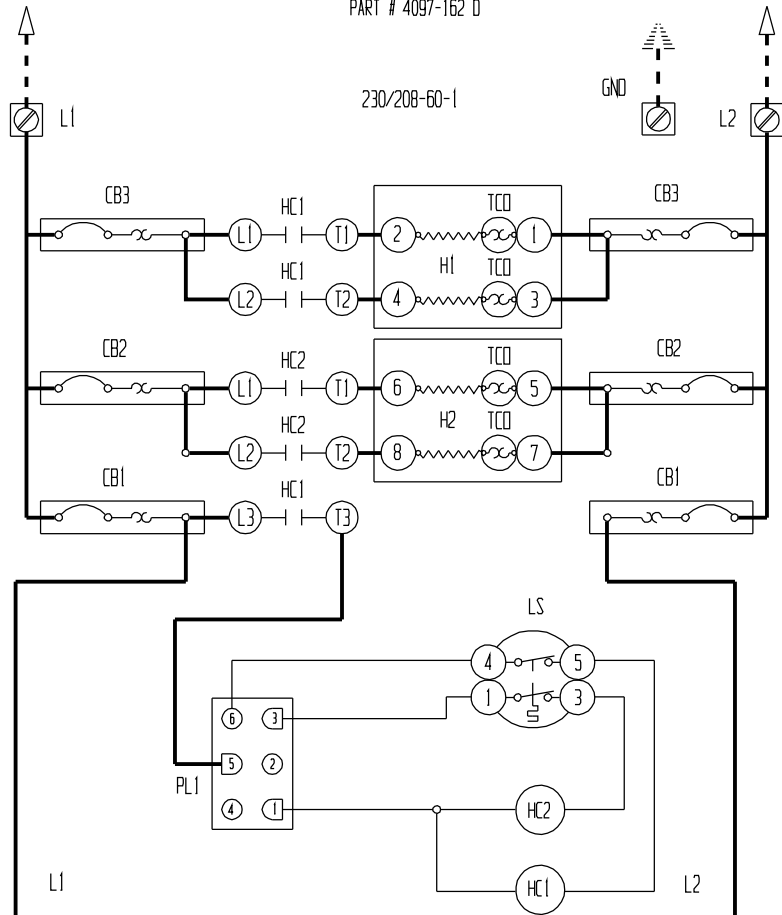

L1

L2