

4097-345

WARNING
USE COPPER CONDUCTORS
ONLY SUITABLE FOR AT LEAST
75° C.

DANGER
ELECTRICAL SHOCK HAZARD
DISCONNECT POWER BEFORE
SERVICING.

Standard Diagram

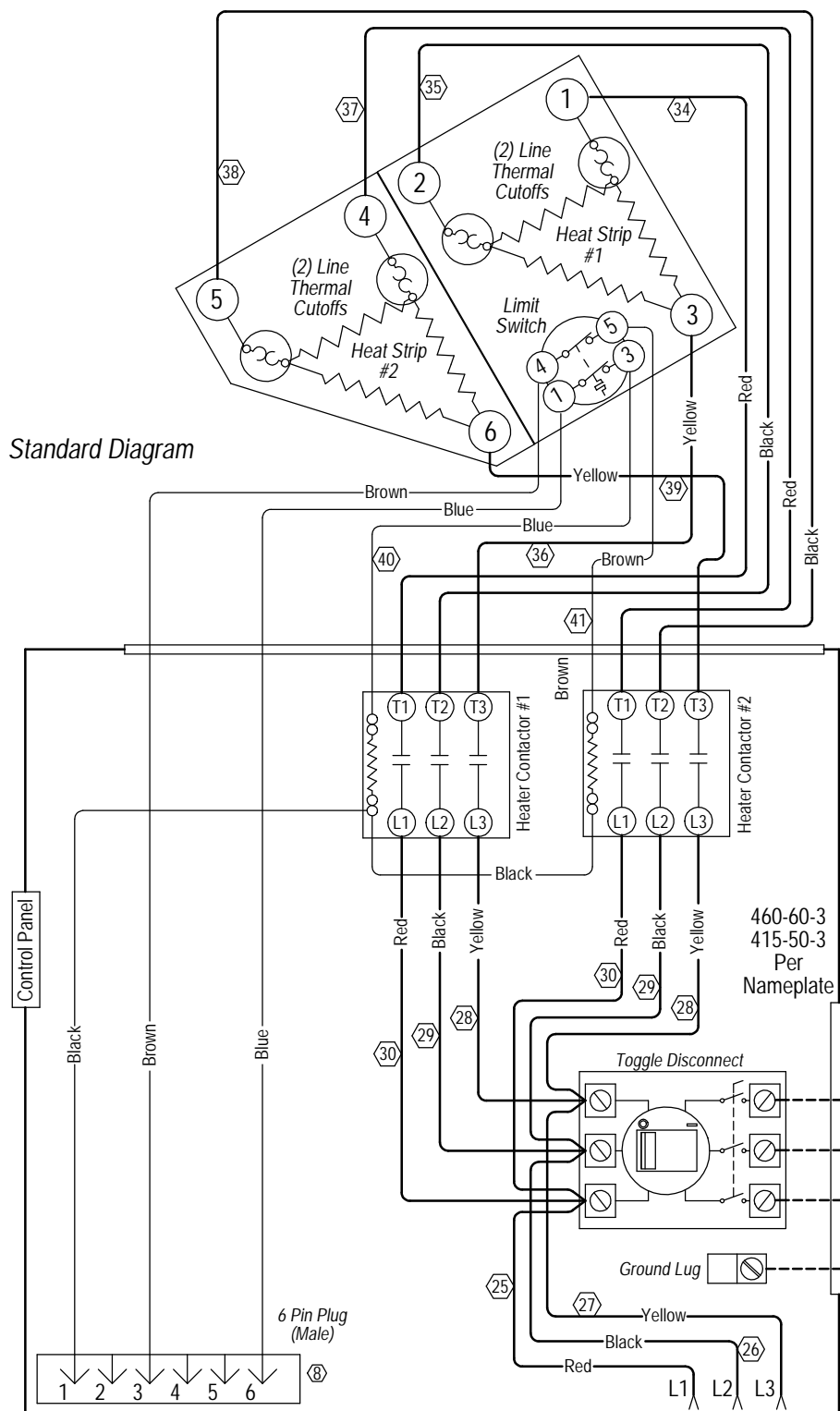

460-60-3
415-50-3
Per Nameplate

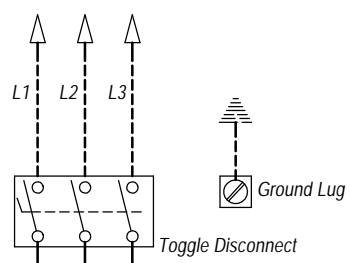

Ladder Diagram

