

4097-700

WARNING
USE COPPER CONDUCTORS
ONLY SUITABLE FOR AT LEAST
75° C.

DANGER
ELECTRICAL SHOCK HAZARD
DISCONNECT POWER BEFORE
SERVICING.

Standard Diagram

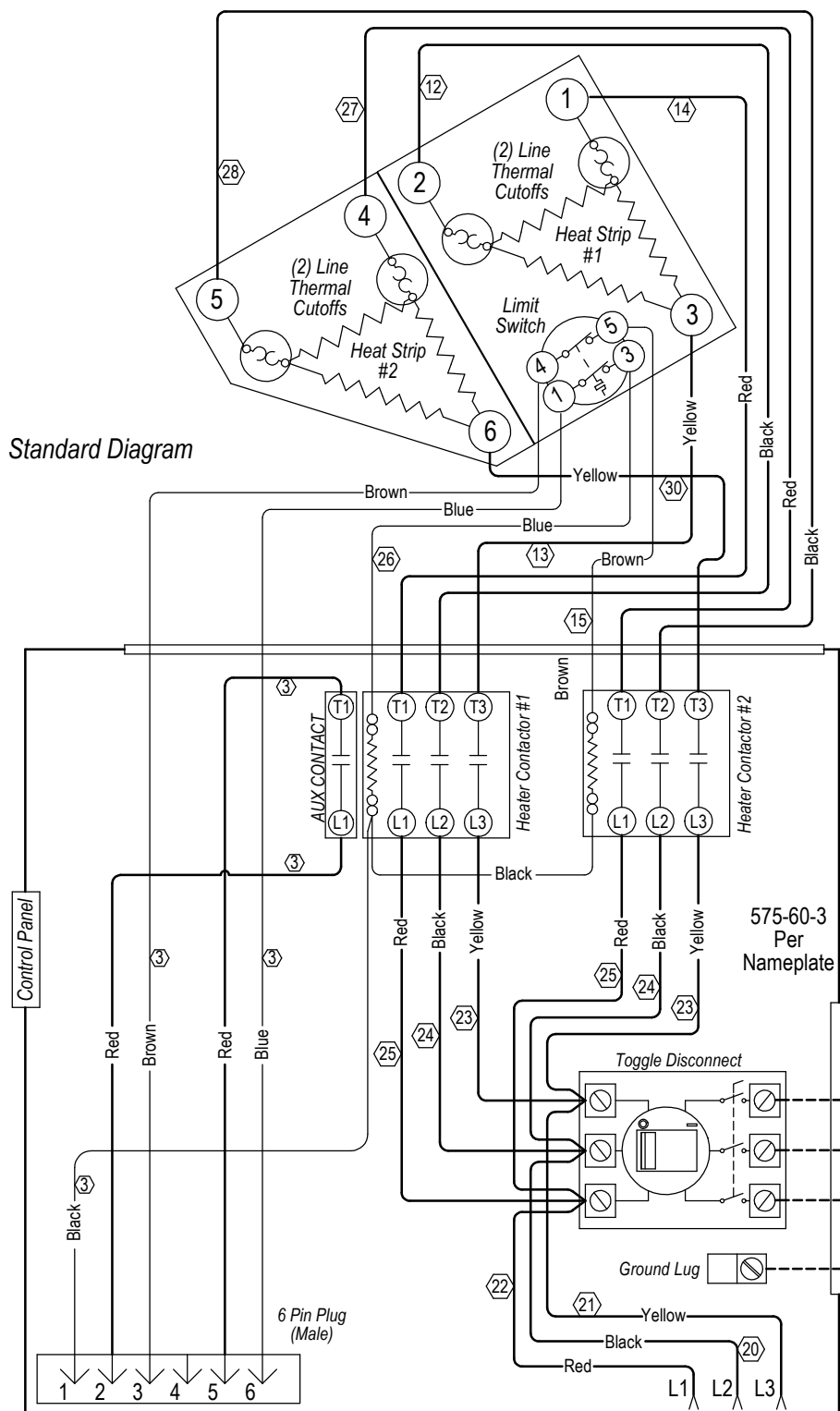

575-60-3
Per Nameplate

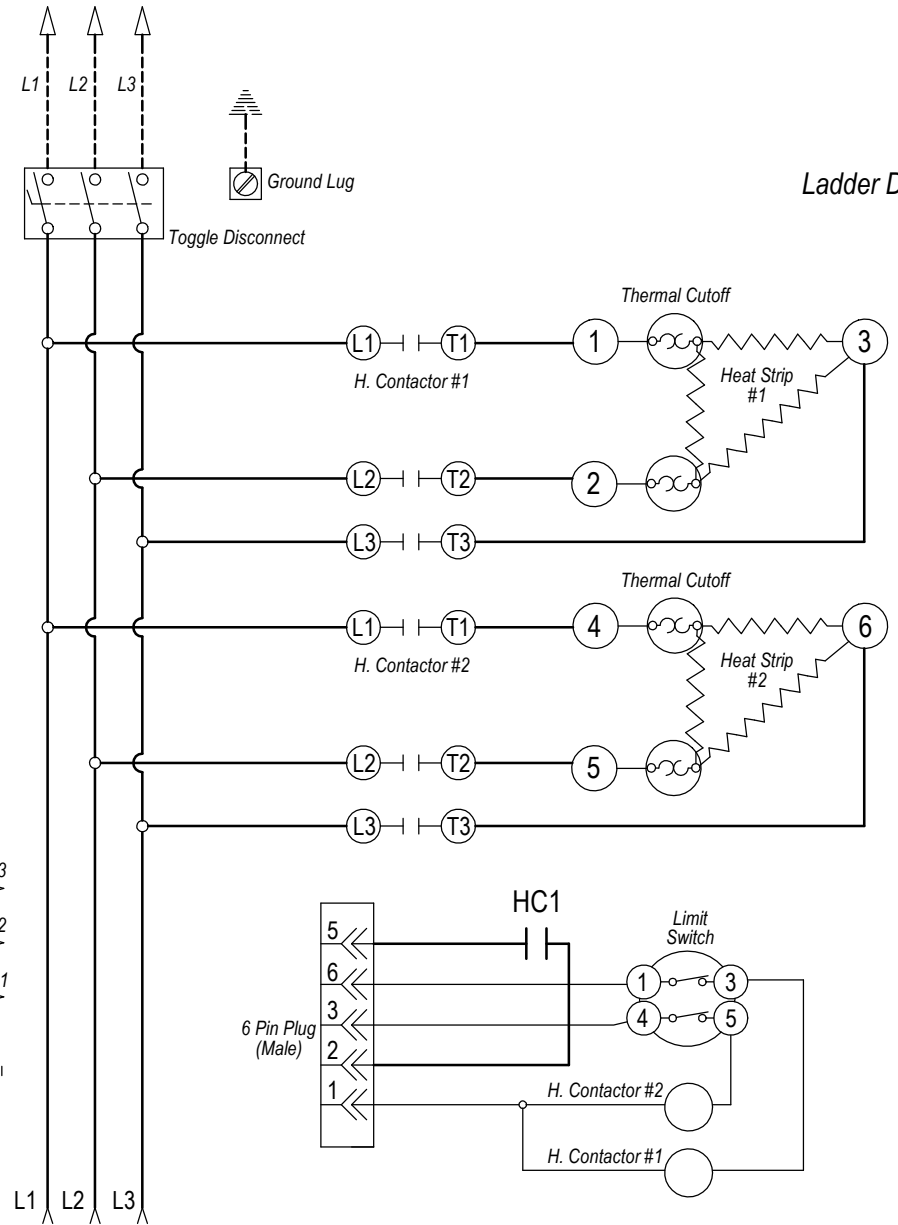

Ladder Diagram