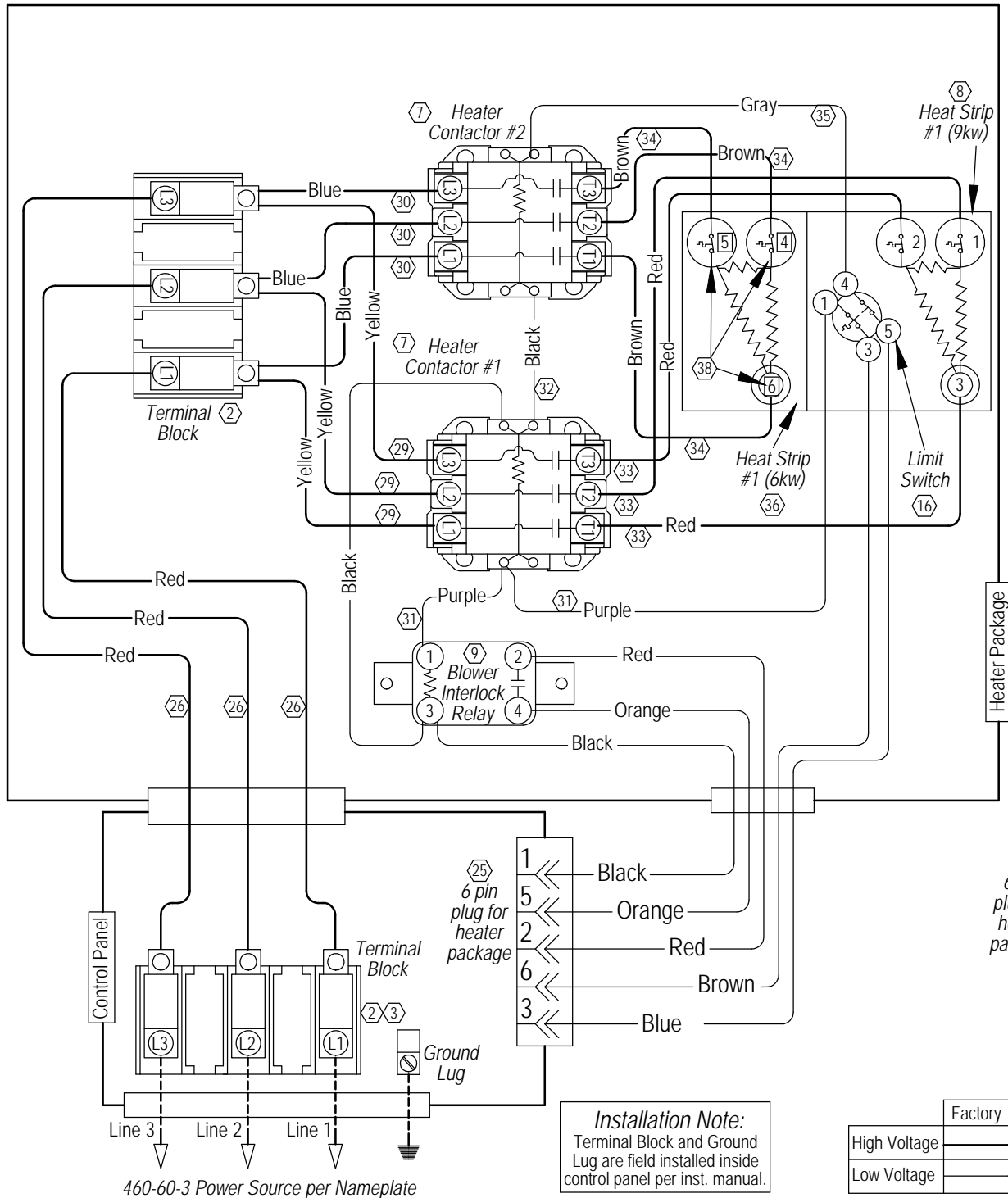
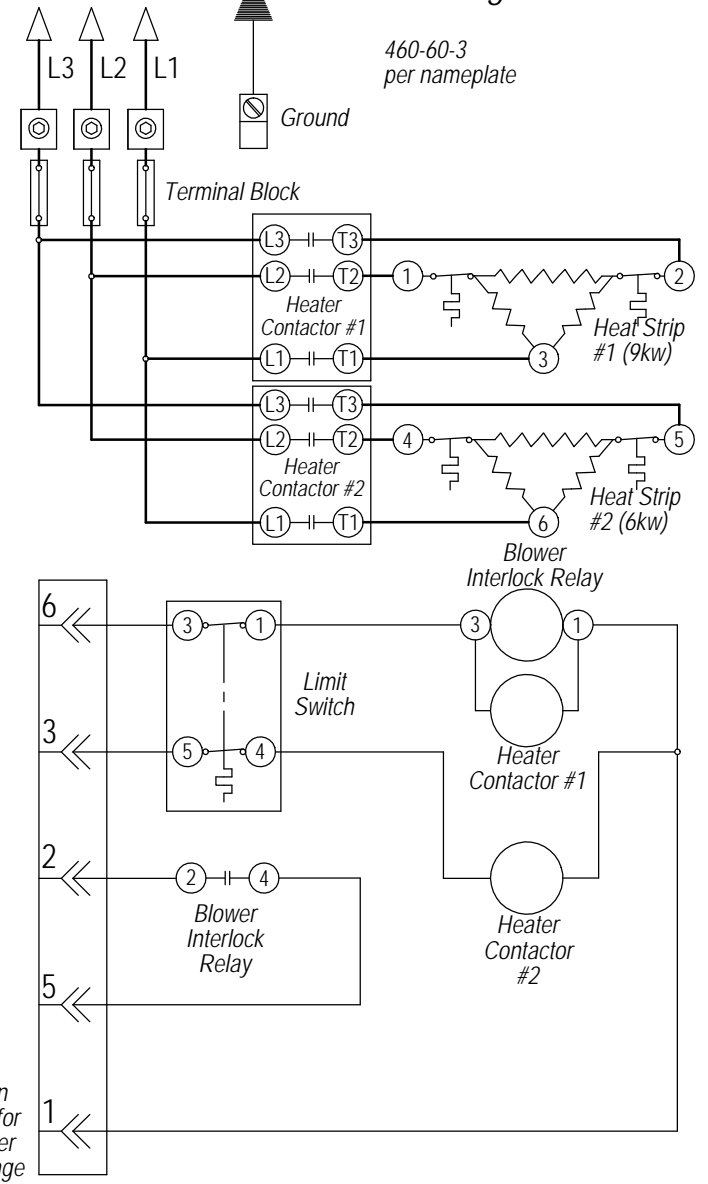

Diagram for 460-60-3 Heater Package



Installation Note:
Terminal Block and Ground Lug are field installed inside control panel per inst. manual.

Ladder Diagram



⚠ DANGER
*ELECTRICAL SHOCK HAZARD
*DISCONNECT POWER BEFORE
SERVICING.

⚠ WARNING
USE COPPER CONDUCTORS
ONLY SUITABLE FOR AT LEAST
75° C.

	Factory	Field	Optional
High Voltage		-----	-----
Low Voltage		-----	-----

4111-301