

For Vent Wiring or controller/thermostat connections, see literature packet or go to www.bardvac.com

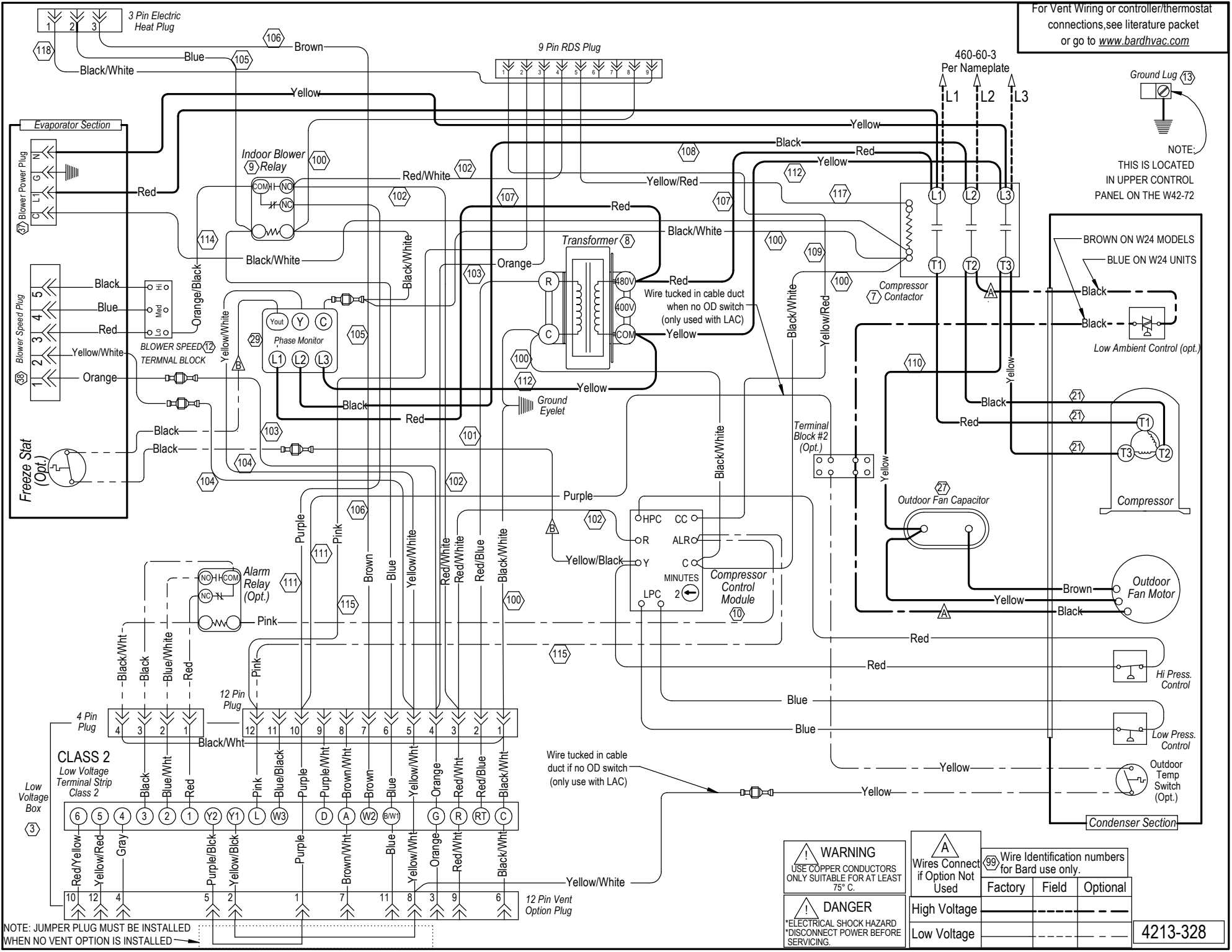

NOTE:
THIS IS LOCATED
IN UPPER CONTROL
PANEL ON THE W42-72

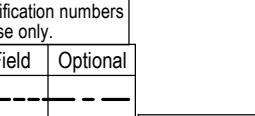
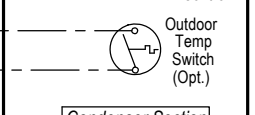
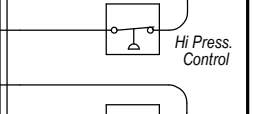
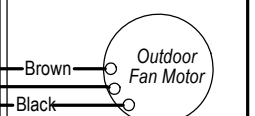
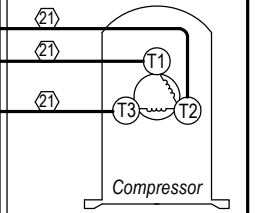
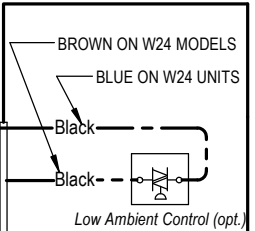

NOTE: JUMPER PLUG MUST BE INSTALLED WHEN NO VENT OPTION IS INSTALLED

WARNING
USE COPPER CONDUCTORS
ONLY SUITABLE FOR AT LEAST
75° C.

DANGER
ELECTRICAL SHOCK HAZARD
DISCONNECT POWER BEFORE
SERVICING.

Wires Connect if Option Not Used	Wire Identification numbers for Bard use only.		
	Factory	Field	Optional
High Voltage			
Low Voltage			

4213-328