

# INSTALLATION INSTRUCTIONS

## MODELS

42HPQ2, 48HPQ5, 60HPQ5

**SPLIT HEAT PUMP UNIT  
OUTDOOR SECTIONS**

## FOR USE WITH

**MODELS BC48A AND BC60A  
INDOOR BLOWER COIL UNITS AND  
MODELS H4AQ1 AND H5AQ1  
COIL ONLY ADD ON UNITS**

## IMPORTANT

The equipment covered in this manual is to be installed by trained, experienced service and installation technicians. Any heat pump is more critical of proper operating charge and an adequate duct system than a straight air conditioning unit. All ductwork, supply and return, must be properly sized for the design air flow requirement of the equipment. ACCA is an excellent guide to proper sizing. All ductwork or portions thereof not in the conditioned space should be properly insulated in order to both conserve energy and prevent condensation or moisture damage.

## SHIPPING DAMAGE

Upon receipt of equipment, the carton should be checked for external signs of shipping damage. If damage is found, the receiving party must contact the last carrier immediately, preferably in writing, requesting inspection by the carrier's agent.

## GENERAL

These instructions explain the recommended method to install the air-cooled split type heat pump, the interconnected refrigerant tubing, and the electrical wiring required for both unit power and control circuit.

These units are to be used in conjunction with the matching indoor coil sections as shown on the specification sheet. Only those combinations as shown are authorized or recommended.

These instructions and any instructions packaged with any separate equipment required to make up the entire heat pump system should be carefully read before beginning the installation. Note particularly any tags and/or local codes in any way. Authorities having jurisdiction should be consulted before the installation is made.

## PRESSURE SERVICE PORTS

High and low pressure service ports are installed on all units so that the system operating pressures can be observed. Pressure curves can be found later in the manual covering all models on both cooling and heating cycles. It is imperative to match the correct pressure curve to the unit by model number.

## SETTING THE UNIT

**General** - The unit must be located outside, or in a well ventilated area. It must not be in the space being heated or cooled. A sound absorbing material should be considered if the unit is to be installed in such a position or location that might cause transmission of sound or vibration to the living area or adjacent buildings.

## SLAB MOUNTING

In areas where winter temperatures DO NOT go below 32°F for periods over twelve hours, the unit may be slab mounted at grade level. When installing unit at grade level, install on a concrete slab at least four inches above finished grade level. Slab should have a slope tolerance away from the building structure of at least 1/4 inch per foot, while being level from side to side. This will prevent ice buildup under the unit during defrost cycles. Place slab in a location where run-off water from higher ground will not collect around unit. See Figure 1.

A minimum of 18 inches should be provided between the coil inlet and any building surfaces. Provide at least four feet between coil outlet and any building wall, fences or other vertical structures. Provide a minimum of three feet clearance on the service access side of the unit. Refer to Figure 2.

## ROOF MOUNTING

When a unit is installed in areas where low ambient temperatures or strong winter winds exist, it should be placed so prevailing winter winds are not in direct line with the heat pump coil. If this is not possible, a wind barrier should be constructed. Place barrier 24 inches from the coil inlet side of the unit and in the direction of prevailing winds. Size barrier at least the same height and width as the unit. See Figure 3.

## WINTER INSTALLATION BELOW 32°F

In areas where winter conditions go below 32°F for extended periods, the unit must be elevated above the mounting surface to prevent snowfall or defrost ice accumulation from interfering with the operation of the unit. A minimum of twelve inch elevation is recommended, while greater elevation may be required for areas of high snow accumulation. Poured concrete, steel framework, brick, cement block, etc. can be utilized to construct a suitable raised mounting platform. See Figure 4.

## WIRING - MAIN POWER

Refer to the unit rating plate for wire sizing information and maximum fuse or "HACR Type" circuit breaker size. Each outdoor unit is marked with a "Minimum Circuit Ampacity." This means that the field wiring used must be sized to carry that amount of current. Depending on the installed Kw of electric heat, there may be two field power circuits required. If this is the case, the unit serial plate will so indicate. Some models are suitable only for connection with copper wire, while others can be wired with either copper or aluminum wire. Each unit and/or wiring diagram will be marked "Use Copper Conductors Only" or "Use Copper or Aluminum Conductors." These instructions MUST BE adhered to. Refer to the National Electrical Code for complete current carrying capacity data on the various insulation grades of wiring material.

The unit rating plate lists a "Maximum Time Delay Fuse" or "HACR Type" circuit breaker that is to be used with the equipment. The correct size must be used for proper circuit protection and also to assure that there will be no nuisance tripping due to the momentary high starting current of the compressor motor.

## WIRING - CONTROL CIRCUIT

Since the same outdoor unit can in most cases be matched with more than one indoor unit, the appropriate control circuit wiring diagrams are included with the indoor coil section installation instructions. These control circuit wiring diagrams cover all the available wiring options required in the various geographic areas of the country.

## COMPRESSOR CUT-OFF THERMOSTAT AND OUTDOOR THERMOSTATS

Heat pump compressor operation at outdoor temperatures below 0°F are neither desirable nor advantageous in terms of efficiency. Since most equipment at time of manufacture is not designated for any specific destination of the country, and most of the equipment is installed in areas not approaching the lower outdoor temperature range, the compressor cut-offs are not factory installed.

Outdoor thermostats are available to hold off various banks of electric heat until needed as determined by outdoor temperature. The set point of either type of thermostat is variable with geographic region and sizing of the heating equipment to the structure. Utilization of the Heating Application Data and the heat loss calculation of the building are useful in determining the correct set points.

## COMPRESSOR CUT-OFF & OUTDOOR THERMOSTAT WIRING

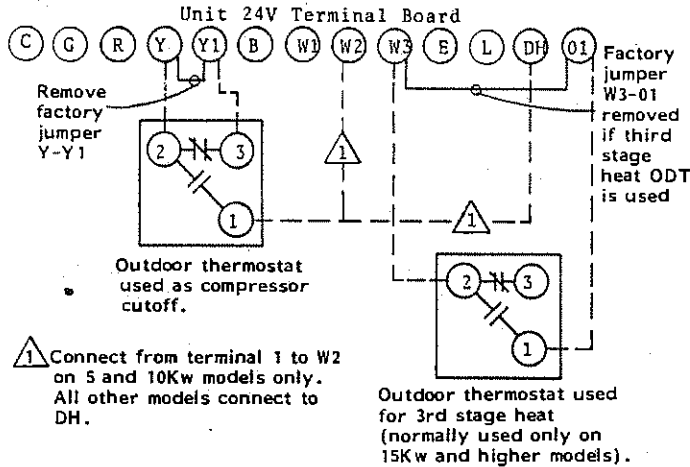

### WALL THERMOSTAT AND SUBBASE COMBINATIONS

Group	Thermostat	Subbase	Predominant Feature
A	8403-017 (T874R1129)	8404-009 (Q674L1181)	Heat or Cool No Auto ①
B	8403-018 (T874N1024)	8404-010 (Q674F1261)	Automatic Heat-Cool Changeover Position ②

① No automatic changeover position--must manually place in heat or cool. Reversing valve remains energized at all times system switch is in heat position (except during defrost cycle). No pressure equalization noise when thermostat is satisfied on either heating or cooling.

② Allows thermostat to control both heating and cooling operation when set in "AUTO" position. Reversing valve de-energizes at end of each "ON" heating cycle.

**IMPORTANT NOTE:** Both thermostat and subbase combinations shown above incorporate the following features: Man-Auto fan switch, Off-Heat-Cool-Em. Heat Switch, and two (2) indicator lamps--one for emergency heat and one for compressor malfunction.

### THERMOSTAT INDICATOR LAMPS

The red lamp marked "EM.HT." comes on and stays on whenever the system switch is placed in the emergency heat position. The green lamp marked "check" will come on if there is any problem that prevents the compressor from running when it is supposed to be.

### EMERGENCY HEAT POSITION

The operator of the equipment must manually place the system switch in this position. This is done when there is a known problem with the outdoor section, or when the green "check" lamp comes on indicating a problem.

### COMPRESSOR MALFUNCTION RELAY (1-Ph models only)

Actuation of the green "check" lamp is accomplished by a voltage type relay which is factory installed. Any condition such as loss of charge, defective capacitor, defective contactor, etc., that will prevent compressor from operating will cause green lamp to activate. This is a signal to the operator of the equipment to place system in emergency heat position.

## SEQUENCE OF OPERATION

**Cooling** - Circuit R-Y makes at thermostat pulling in compressor contactor starting the compressor and outdoor motor. The G (indoor motor) circuit is automatically completed on any call for cooling operation, or can be energized by manual fan switch on subbase for constant air circulation.

**Heating** - A 24V solenoid coil on reversing valve controls heating cycle operation. Two thermostat options, one allowing "Auto" changeover from cycle to cycle and the other constantly energizing solenoid coil during heating season and thus eliminating pressure equalization noise except during defrost, are to be used. On "Auto" option, a circuit is completed from R-W1 and R-Y on each heating "on" cycle, energizing reversing valve solenoid and pulling in compressor contactor starting compressor and outdoor motor. R-G also make starting indoor blower motor. Heat pump heating cycle is now in operation. The second option has no "Auto" changeover position, but instead energizes the reversing valve solenoid constantly whenever the system switch on subbase is placed in "heat" position, the "B" terminal being constantly energized from R. A thermostat demand for heat completes R-Y circuit, pulling in compressor contactor starting compressor and outdoor motor. R-G also make starting indoor blower motor.

### DEFROST CYCLE

The defrost cycle is controlled by time and temperature. The 24 volt timer motor runs all the time the compressor is in operation. When the outdoor temperature is in the lower 40°F temperature range or colder, the outdoor coil temperature is 32°F or below. This temperature is sensed by the defrost thermostat mounted near the bottom of the outdoor coil on a return bend. The defrost thermostat closes at approximately 32°F. Every 60 (or 30) minutes that the compressor is running, contacts 3-5 close for 7 minutes, with contacts 3-4 closed for the first 40 seconds of that 7 minutes. If the defrost thermostat is closed, the defrost relay energizes and places the system in defrost mode. An interlocking circuit is created with timer contacts 3-5 and defrost relay contacts 7-9 in series.

During the defrost mode, the refrigerant cycle switches back to the cooling cycle, the outdoor motor stops, electric heaters are energized, and hot gas passing through the outdoor coil melts any accumulated frost. When the temperature rises to approximately 57°F, the defrost thermostat opens, de-energizing the defrost relay and returning the system to heating operation.

If some abnormal or temporary condition such as a high wind causes the heat pump to have a prolonged defrost cycle, contacts 3-5 of the defrost timer will open after 7 minutes and restore the system to heating operations automatically.

There are two time settings on the defrost timer--30 minutes and 60 minutes. Most models are shipped wired on the 60 minute setting for greatest operating economy. If special circumstances require a change to the shorter time, remove wire connected to terminal 5/60 and reconnect to terminal 5/30. See next page.

There is a manual advance knob located on the timer. This can be used to advance timer to contact closure point if it is desired to check out defrost cycle operation without waiting for time to elapse.

If this unit is operated in cooling below a 65° outdoor ambient temperature, the installation of low ambient controls (LAC-1 and 8201-008 relay) to unit is required.

## DEFROST TIMER WIRING

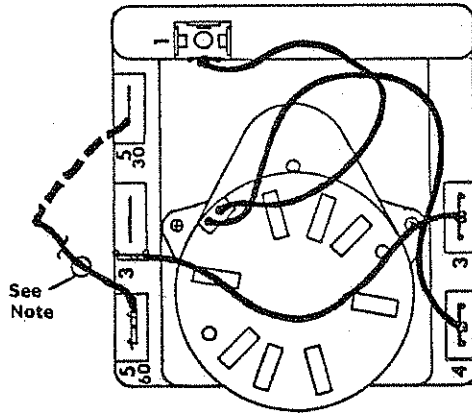

**NOTE:** All models are connected to 5/60 terminal (60 minute). Any model can be changed from 60 minutes to 30 minutes by unplugging from 5/60 terminal and reconnecting to 5/30 terminal as shown by dotted line.

## REFRIGERANT CHARGE

The correct system R-22 is shown on the unit rating plate. Optimum unit performance will occur with a refrigerant charge resulting in a suction line temperature (6" from compressor) as shown in the following table:

Models	Rated Airflow	95°F O.D. Temp.	82°F O.D. Temp.
42HPQ2/BC48A 42HPQ2/H4AQ1	1540 1625	57 - 59 50 - 52	65 - 67 56 - 58
48HPQ4/BC48A 48HPQ4/H4AQ1	1650 1625	54 - 57 49 - 51	67 - 69 59 - 61
60HPQ5/BC60A 60HPQ5/H5AQ1	1800 1800	56 - 58 57 - 59	65 - 67 65 - 67

**NOTE:** The suction line temperatures are based upon 80°F dry bulb/67°F wet bulb (50% R.H.) temperature and rated air flow across the evaporator during cooling cycle.

## SERVICE HINTS

1. Caution homeowner to maintain clean air filters at all times. Also, not to needlessly close off supply and return air registers. This reduces air flow through the system, which shortens equipment service life as well as increasing operating costs.
2. Switching to heating cycle at 75°F or higher outside temperature may cause a nuisance trip of the manual reset high pressure switch.
3. The heat pump wall thermostats perform multiple functions. Be sure that all function switches are correctly set for the desired operating mode before trying to diagnose any reported service problems.
4. Check all power fuses or circuit breakers to be sure that they are the correct rating.
5. Periodic cleaning of the outdoor coil to permit full and unrestricted air flow circulation is essential.

## CRANKCASE HEATERS

All units are provided with some form of compressor crankcase heat. Some single phase units utilize the compressor motor start winding in series with a portion of the run capacitor to generate heat within the compressor shell to prevent liquid refrigerant migration.

Some three phase units utilize a wraparound type of crankcase heater that warms the compressor oil from the outside.

Some single and three phase models have an insertion well-type heater located in the lower section of the compressor housing. This is a self-regulating type heater that draws only enough power to maintain the compressor at a safe temperature.

Some form of crankcase heat is essential to prevent liquid refrigerant from migrating to the compressor, causing oil pump out on compressor start-up and possible valve failure due to compressing a liquid.

Refer to unit wiring diagram to find exact type of crankcase heater used.

The following decal is affixed to all outdoor units detailing start-up procedure. This is very important. Please read carefully.

### IMPORTANT

THESE PROCEDURES MUST BE FOLLOWED AT INITIAL START-UP AND AT ANY TIME POWER HAS BEEN REMOVED FOR 12 HOURS OR LONGER.

TO PREVENT COMPRESSOR DAMAGE WHICH MAY RESULT FROM THE PRESENCE OF LIQUID REFRIGERANT IN THE COMPRESSOR CRANKCASE

1. MAKE CERTAIN THE ROOM THERMOSTAT IS IN THE "OFF" POSITION (THE COMPRESSOR IS NOT TO OPERATE).

2. APPLY POWER BY CLOSING THE SYSTEM DISCONNECT SWITCH. THIS ENERGIZES THE COMPRESSOR HEATER WHICH EVAPORATES THE LIQUID REFRIGERANT IN THE CRANKCASE.

3. ALLOW 4 HOURS OR 60 MINUTES PER POUND OF REFRIGERANT IN THE SYSTEM AS NOTED ON THE UNIT RATING PLATE, WHICHEVER IS GREATER.

4. AFTER PROPERLY ELAPSED TIME THE THERMOSTAT MAY BE SET TO OPERATE THE COMPRESSOR.

5. EXCEPT AS REQUIRED FOR SAFETY WHILE SERVICING - DO NOT OPEN SYSTEM DISCONNECT SWITCH.

7961-061

## IMPORTANT INSTALLER NOTE

For improved start-up performance, wash the indoor coil with a dishwasher detergent.

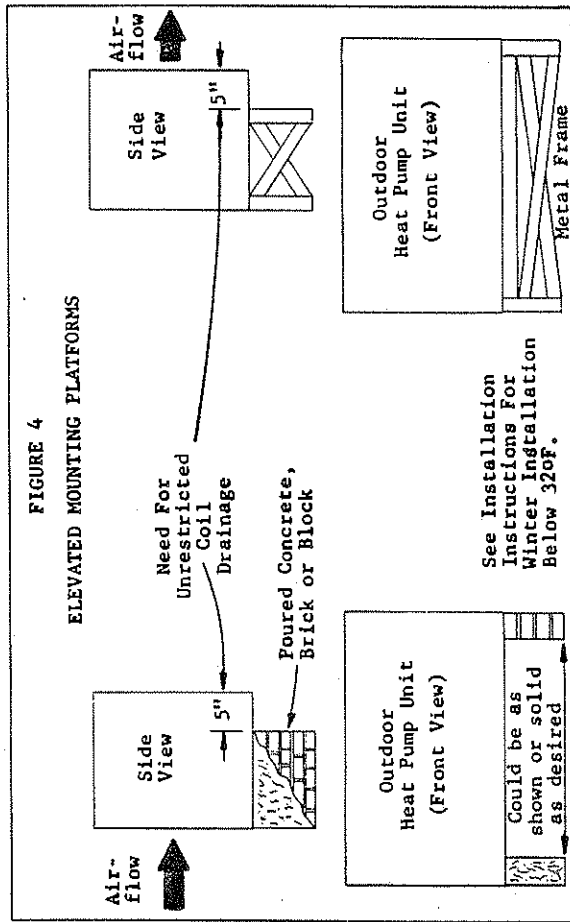
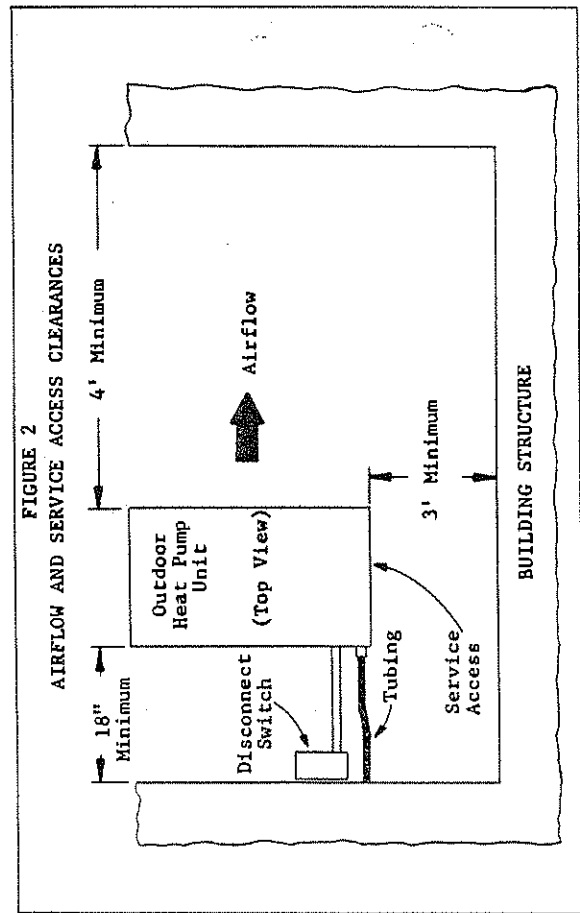
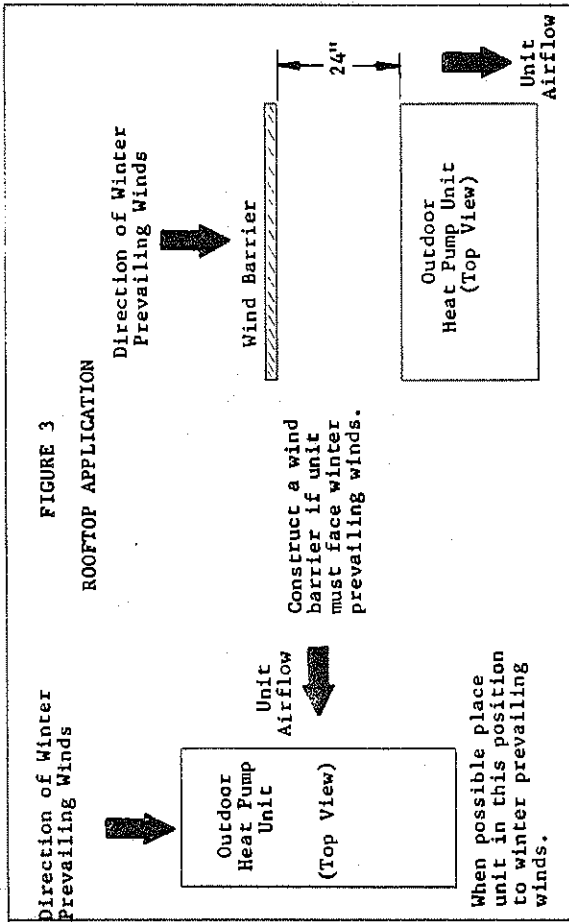
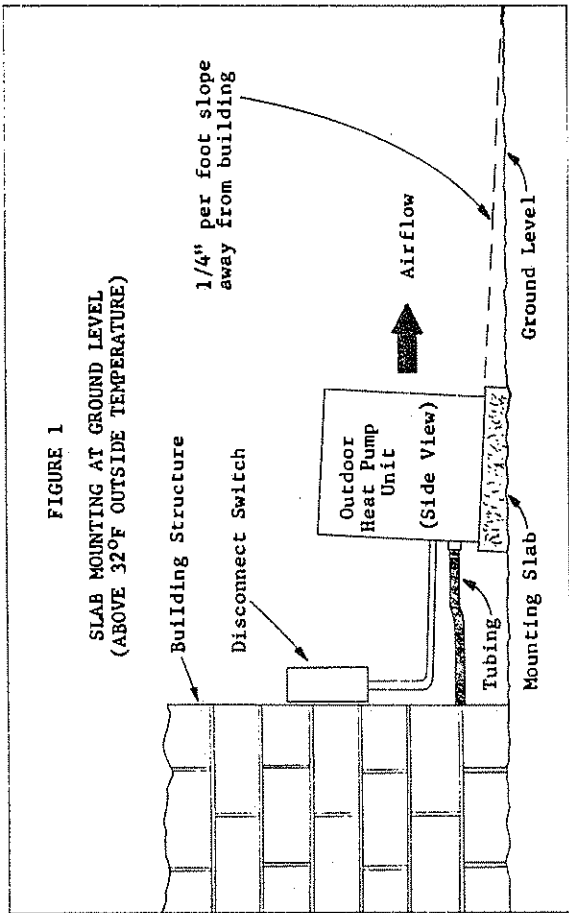

## INSTALLING REFRIGERANT TUBING

**PRE-CHARGED TUBING** - Examine carefully the two lengths of pre-charged tubing furnished with the unit. The larger is the suction line. The smaller is the liquid line. The end of the tubing with the hex nut and gauge port is to be attached to the condensing unit.

Unroll the tubing, being careful not to kink, and install it between the condensing unit and the evaporator coil.

**CAUTION:** Be careful not to tear the insulation when pushing it through holes in masonry or frame walls.

When sealing tube opening in house wall use a soft material to prevent tube damage and vibration transmission.

Before fastening either end, use a tubing bender to make any necessary bends in the tubing. **AVOID EXCESSIVE BENDING IN ANY ONE PLACE TO AVOID KINKING.**

Start connecting the tubing at the evaporator coil end, first remove the protective caps and plugs from the quick-connect fittings on the evaporator coil and the pre-charged tubing. Inspect fittings and clean if necessary, making sure they are clear of foreign materials. If you clean the fittings, lubricate them with refrigeration oil. Connect both tubes to the fittings on the coil and draw up by hand.

When necessary to bend the insulated tube, suction line, cut the insulation around its circumference at a distance far enough beyond the point of the bend so as to clear the tubing bender.

Slip the insulation back together and vapor seal the joint with tape.

**NOTE:** The maximum distance for pre-charge tubing between the condenser and the evaporator is 45 feet.

**CAUTION:** Prior to connecting the pre-charged tubing to the evaporator coil or condensing unit, be sure all bends have been made, then coil any excess tubing in a horizontal plane, with the slope of the tubing toward the condensing unit.

**CAUTION:** Be sure to hold the coupling firmly to prevent movement of the coupling and tubing. Failure to do so could tear out the diaphragm causing a blockage of the system.

**CAUTION:** After starting to tighten up the fitting never try to back it off or take it apart.

For connecting the tubing at the condensing unit end, first remove the protective caps and plugs from the quick-connect fittings on the condensing unit and the pre-charged tubing. Inspect fittings and clean if necessary, making sure they are clear of foreign materials. If you clean the fittings, lubricate them with refrigeration oil. Connect both tubes to the fittings on the coil and draw up by hand.

Locate the gauge port in a 45° angle from a vertical up position so as to be accessible for gauge connections.

Use a wrench on the hex nut of the female fitting backing up the fitting with another wrench to keep tube from turning. Tighten the fittings together until they bottom out then tighten for an additional 1/4 turn so that coupling will seat properly.

Check the gauge port cap to make sure it is tight. If loose, tighten, being careful not to tighten too much as it will damage the valve in the gauge port.

Leak test all connections using an Electronic Leak Detector or a Halide Torch.

When tubing is installed in attics or drop ceiling, insulate the quick connect fitting on the larger tube thoroughly with 3/8" wall thickness, closed cell sponge tube insulation or equivalent. Failure to insulate will result in water damage to ceiling since the fitting will "sweat" and drop water on the ceiling.

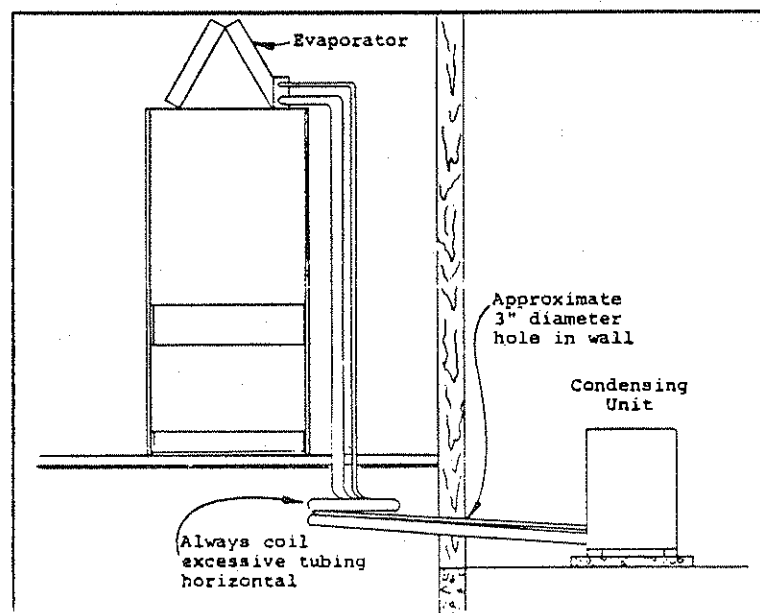

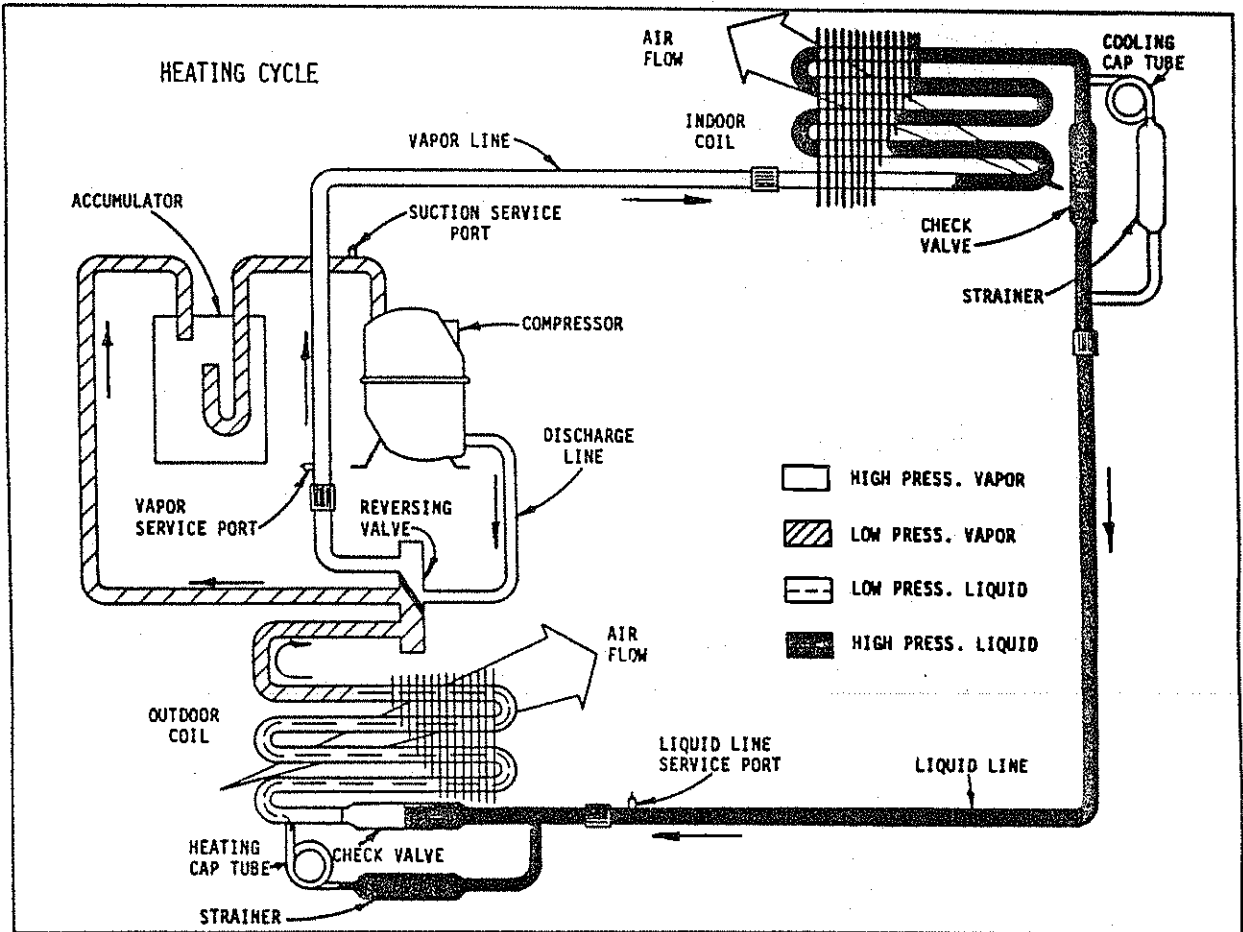
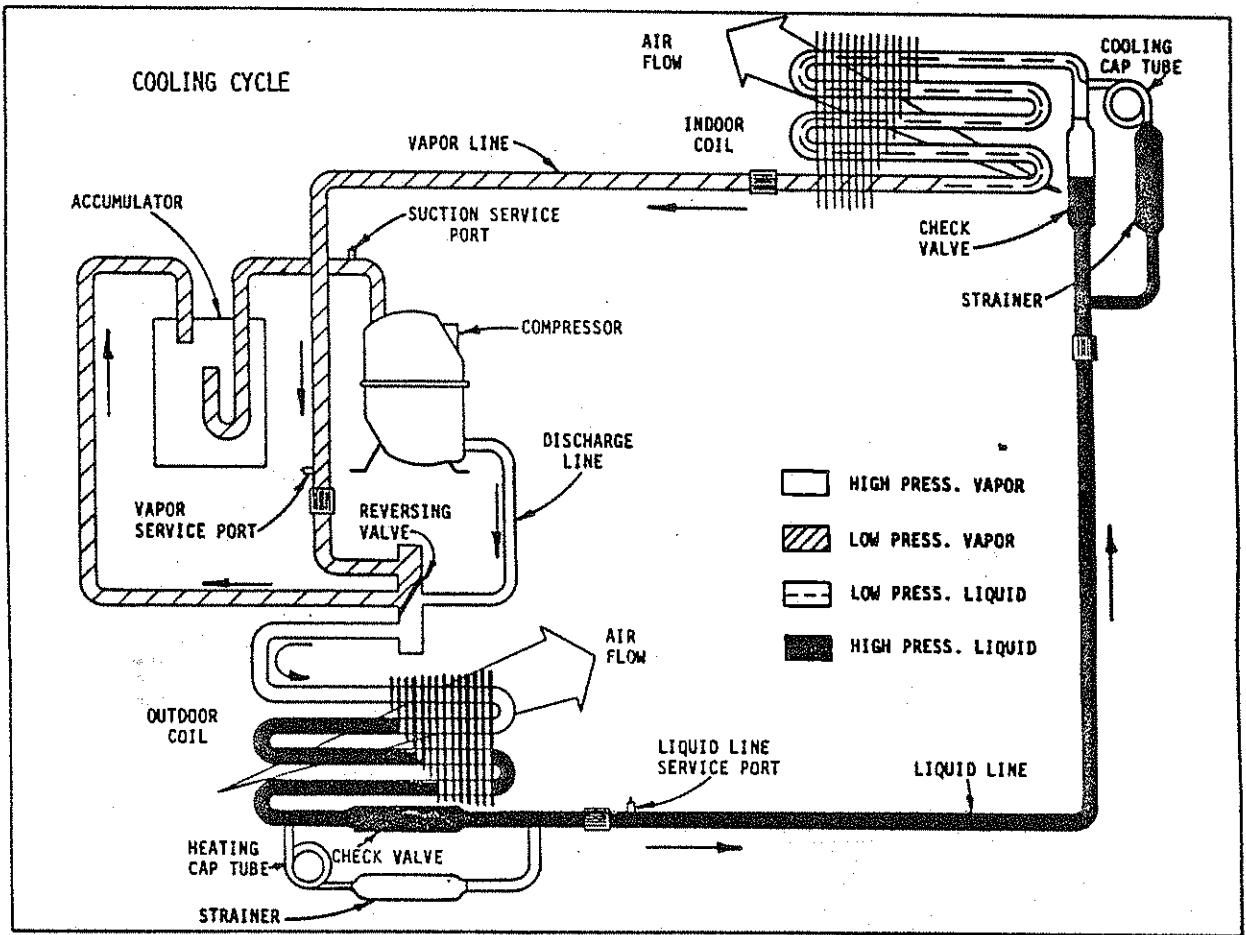

**PARTS LIST**  
**SPLIT SYSTEM HEAT PUMPS**

3/87

Part No.	Description	42HPQ2	42HPQ2-B	48HPQ5	48HPQ5-B	60HPQ5	60HPQ5-B	42HPQ2-C 460V	48HPQ5-C 460V	60HPQ5-C 460V
5202-007	Accumulator	x	x							
5202-005	Accumulator			x	x	x	x	x	x	x
8552-030	Capacitor 40/440V	x		x						
8552-043	Capacitor 45/370V					(2)				
8552-026	Capacitor 15/370V	x	x	x	x	x	x	x	x	x
5811-021	Capillary Tube - Heat			(2)	(2)				(2)	
5811-018	Capillary Tube - Heat	(2)	(2)					(2)		
5811-025	Capillary Tube - Heat					(2)	(2)			(2)
8000-072	Compressor AV144ET	x								
8000-088	Compressor AV145RT		x							
8000-081	Compressor AV168ET			x						
8000-082	Compressor AV169RT				x					
8000-074	Compressor AG134ET					x				
8000-075	Compressor AG134RT						x			
8000-089	Compressor AV145TT							x		
8000-083	Compressor AV169TT								x	
8000-049	Compressor AG133UT									x
5051-037	Condenser Coil	x	x					x		
5051-029	Condenser Coil								x	x
8401-003	Contactora - Comp. 30A	x		x	x	x	x		x	x
8401-002	Contactora - Comp. 25A		x		x			x	x	x
8401-011	Contactora - Comp. 30A						x			
8401-016	Contactora - Comp. 35A					x				
5651-036	Check Valve	x	x	x	x	x	x	x	x	x
8407-003	Transformer - Stepdown							x	x	x
8408-017	Defrost Thermostat	x	x	x	x	x	x	x	x	x
5151-017	Fan Blade FA2430-4B	x	x	x	x	x	x	x	x	x
7051-005	Grille - Condenser	x	x	x	x	x	x	x	x	x
7051-004	Wire Grille - Inlet	x	x	x	x	x	x	x	x	x
8406-011	High Pressure Switch	x	x	x	x	x	x	x	x	x
8105-021	Motor - Fan 1/3	x	x	x	x	x	x	x	x	x
8200-004	Motor Mount - Fan	x	x	x	x	x	x	x	x	x
8201-047	Relay - Defrost	x	x	x	x	x	x	x	x	x
8201-024	Relay - Compressor Fault	x	x	x	x	x	x	x	x	x
5650-006	Reversing Valve	x	x	x	x			x	x	
5650-010	Reversing Valve					x	x			x
5650-008	Solenoid Coil	x	x	x	x	x	x	x	x	x
5210-005	Strainer	x	x	x	x	x	x	x	x	x
8607-017	Terminal Block							x	x	x
8607-011	Terminal Block	x	x	x	x	x	x	x	x	x
8612-012	Timer	x	x	x	x	x	x	x	x	x
4039-110	Wiring Diagram	x								
4039-210	Wiring Diagram		x							
4039-310	Wiring Diagram							x		
4040-110	Wiring Diagram			x						
4040-111	Wiring Diagram					x				
4040-210	Wiring Diagram				x		x			
4040-310	Wiring Diagram								x	x

Minimum net billing \$15.00. Supersedes all previous lists.  
Subject to change without notice.



**SPLIT HEAT PUMP**  
 Model 42HPQ2 with BC48A Blower Coil or H4AQ1

12/84

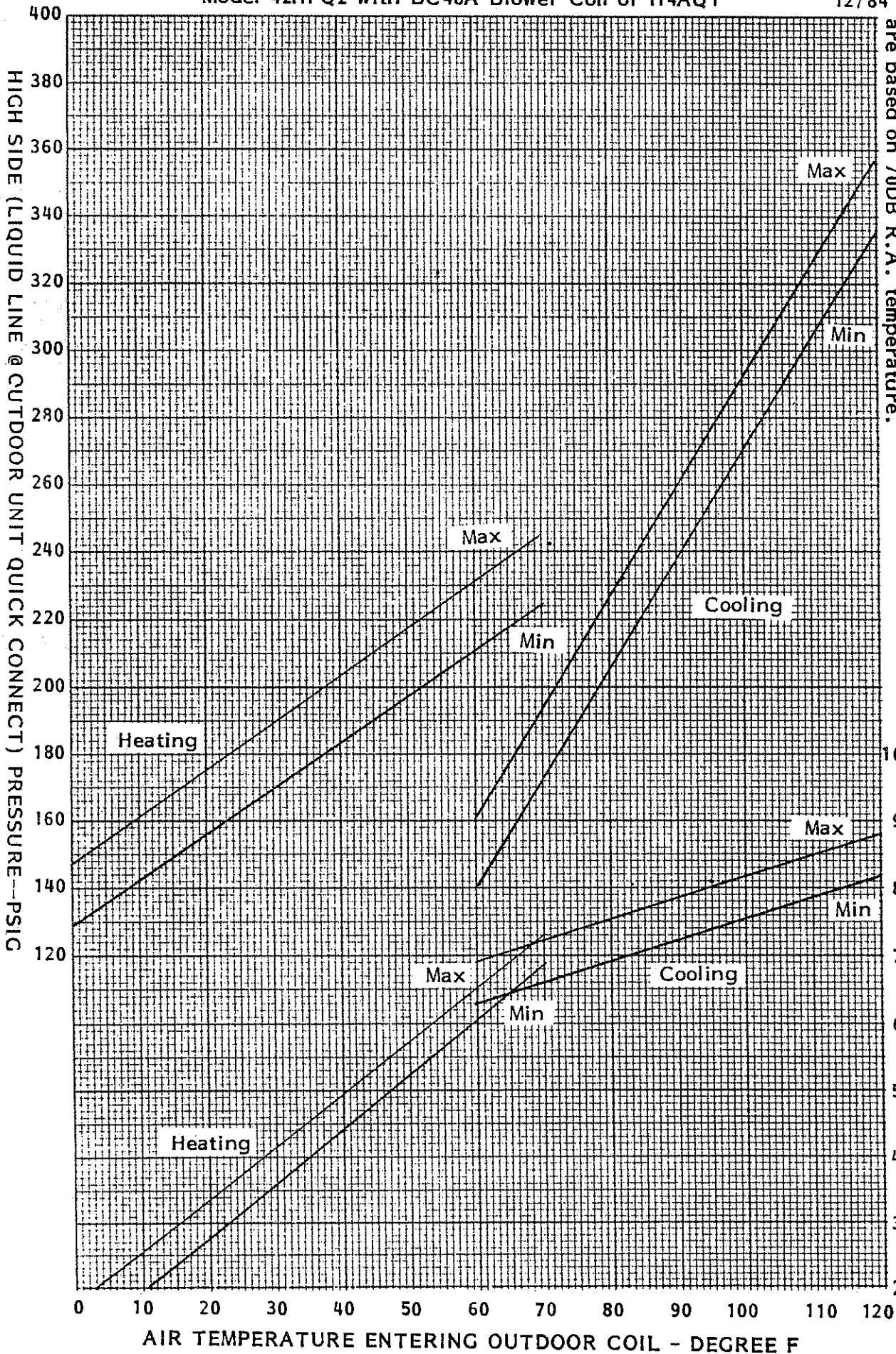

Cooling curves are based upon 80DB, 67WB Temp. and rated CFM (airflow) across the evaporator coil and should be used for reference purposes only. Specific information can be found under section titled "Refrigerant Charge" elsewhere in manual. If there is any doubt as to correct operating charge being in the system, the charge should be removed, system evacuated, and recharged according to serial plate instructions. Heating curves are based on 70DB R.A. temperature.

LOW SIDE PRESSURE -- PSIG  
 (Suction Line Between Accumulator & Compressor)

**SPLIT HEAT PUMP**  
 Model 48HPQ5 with BC48A Blower Coil or H4AQ1

12/84

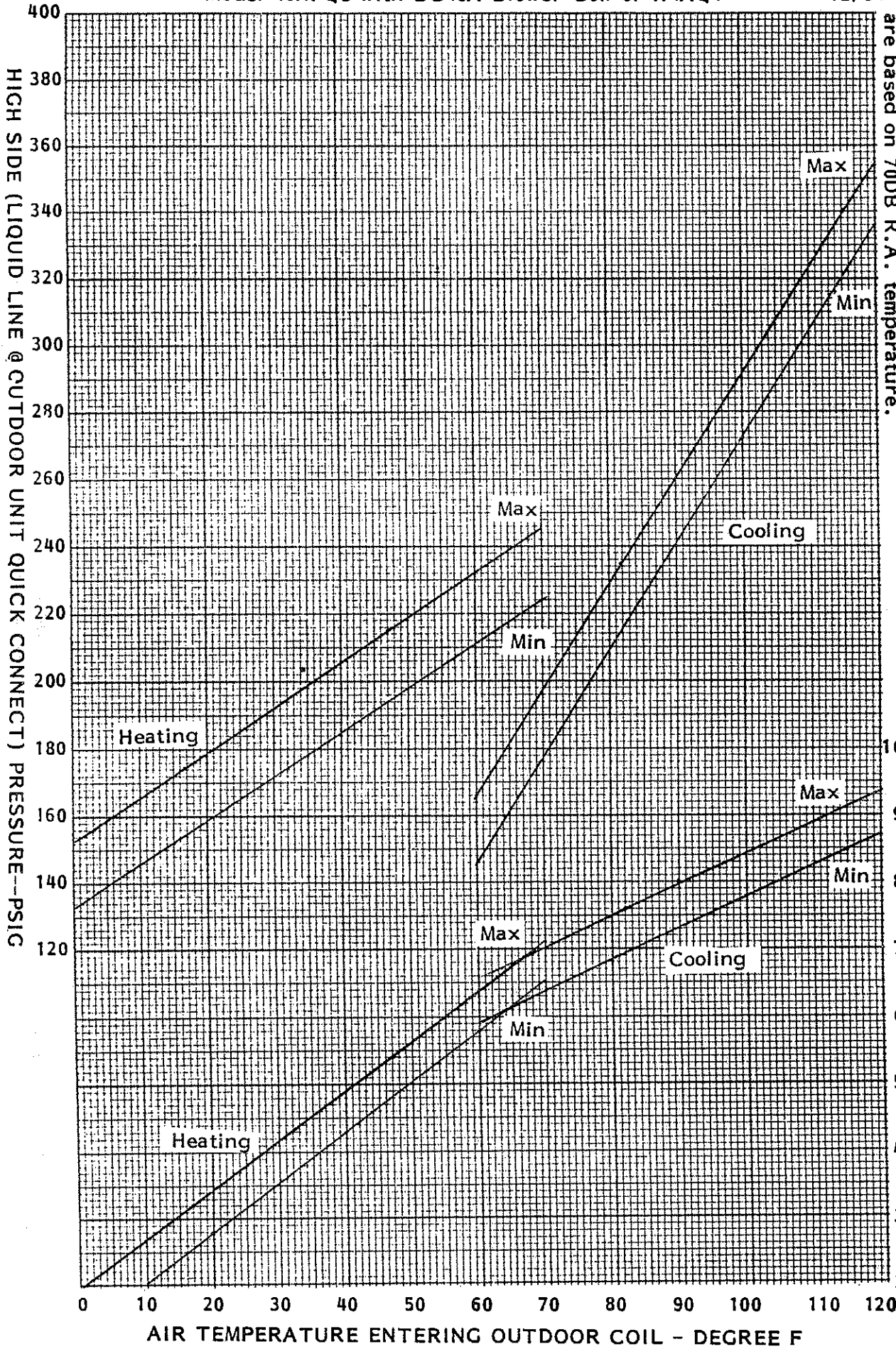

Cooling curves are based upon 80DB, 67WB Temp. and rated CFM (shown) across the evaporator coil and should be used for reference purposes only. Specific information can be found under section titled "Refrigerant Charge" elsewhere in manual. If there is any doubt as to correct operating charge being in the system, the charge should be removed, system evacuated, and recharged according to serial plate instructions. Heating curves are based on 70DB R.A. temperature.

LOW SIDE PRESSURE -- PSIG  
 (Suction Line Between Accumulator & Compressor)

BARD MANUFACTURING CO.  
SPLIT HEAT PUMP

MODEL 60HPQ5 with RC60A INDOOR COIL (BLOWER COIL)

884

H5A01

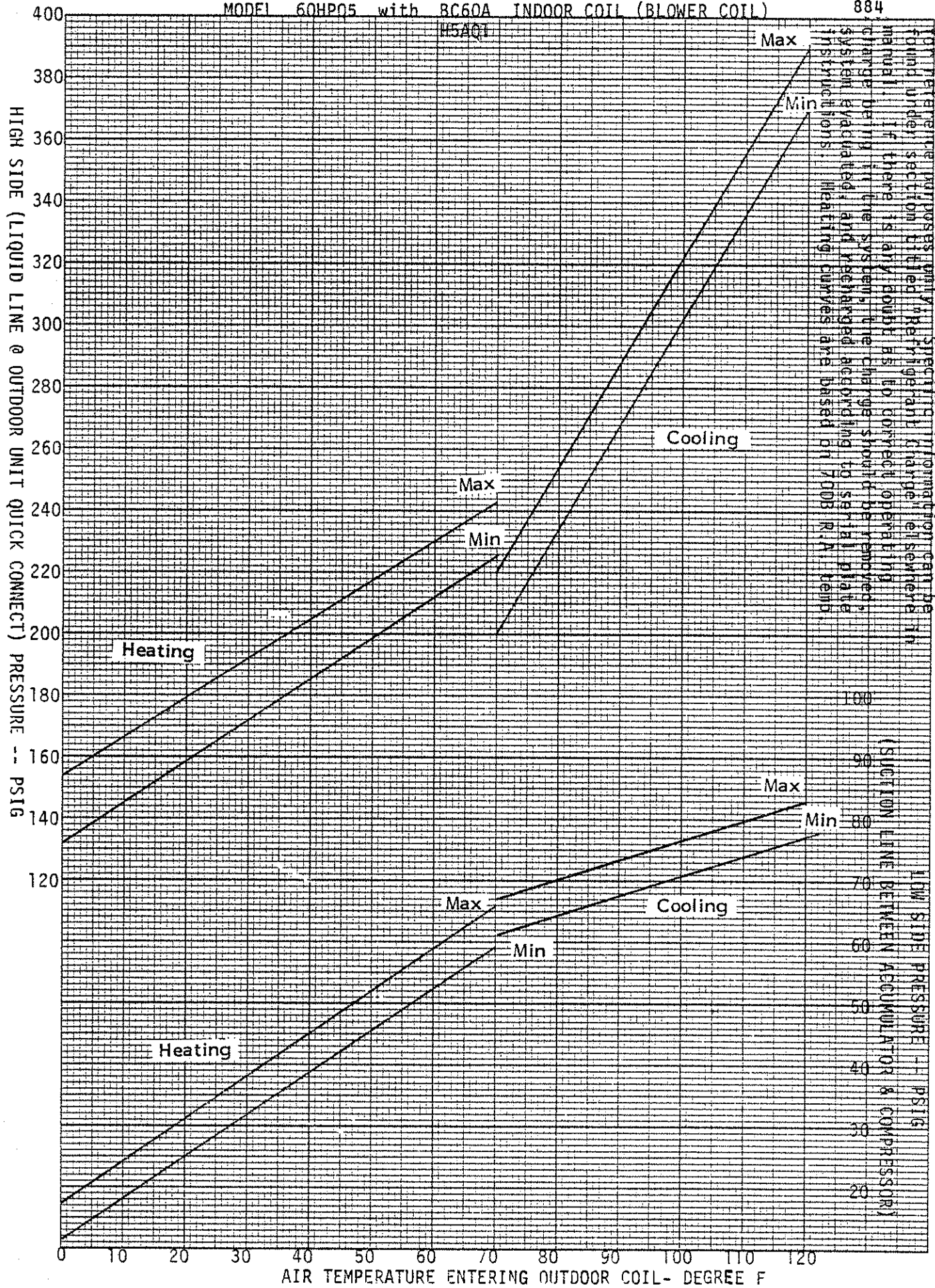

Cooling curves are based upon 1000, 0/100 K.A. Temp. and Rated CFM (airflow) across the evaporator coil and should be used

For reference purposes only. Specific information can be found under section titled in Refrigerant charge elsewhere in manual. If there is any doubt as to correct operating change being in the system, the charge should be removed, system evacuated and recharged according to serial plate instructions. Heating curves are based on 1000 R.A. Temp.

DIETZEN CORPORATION  
MADE IN U.S.A.

NO. 34DR-20 DIETZEN GRAPH PAPER  
20 X 20 PER INCH

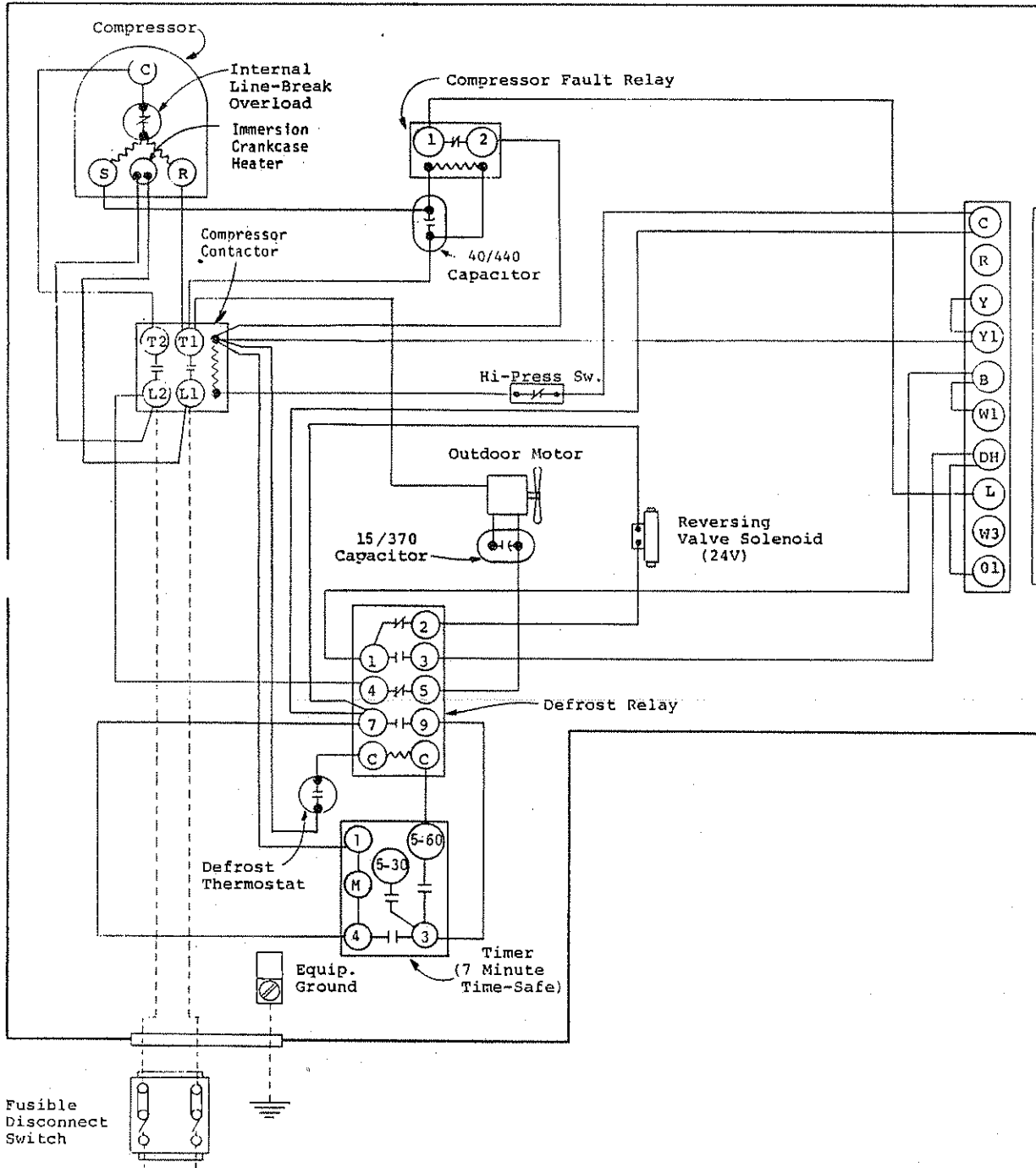

Refer to  
Installation  
Instructions  
for Control  
Circuit Wiring

Fusible  
Disconnect  
Switch

230/208-60-1

USE COPPER CONDUCTORS ONLY

Factory Wire \_\_\_\_\_  
Field Wire - - - -

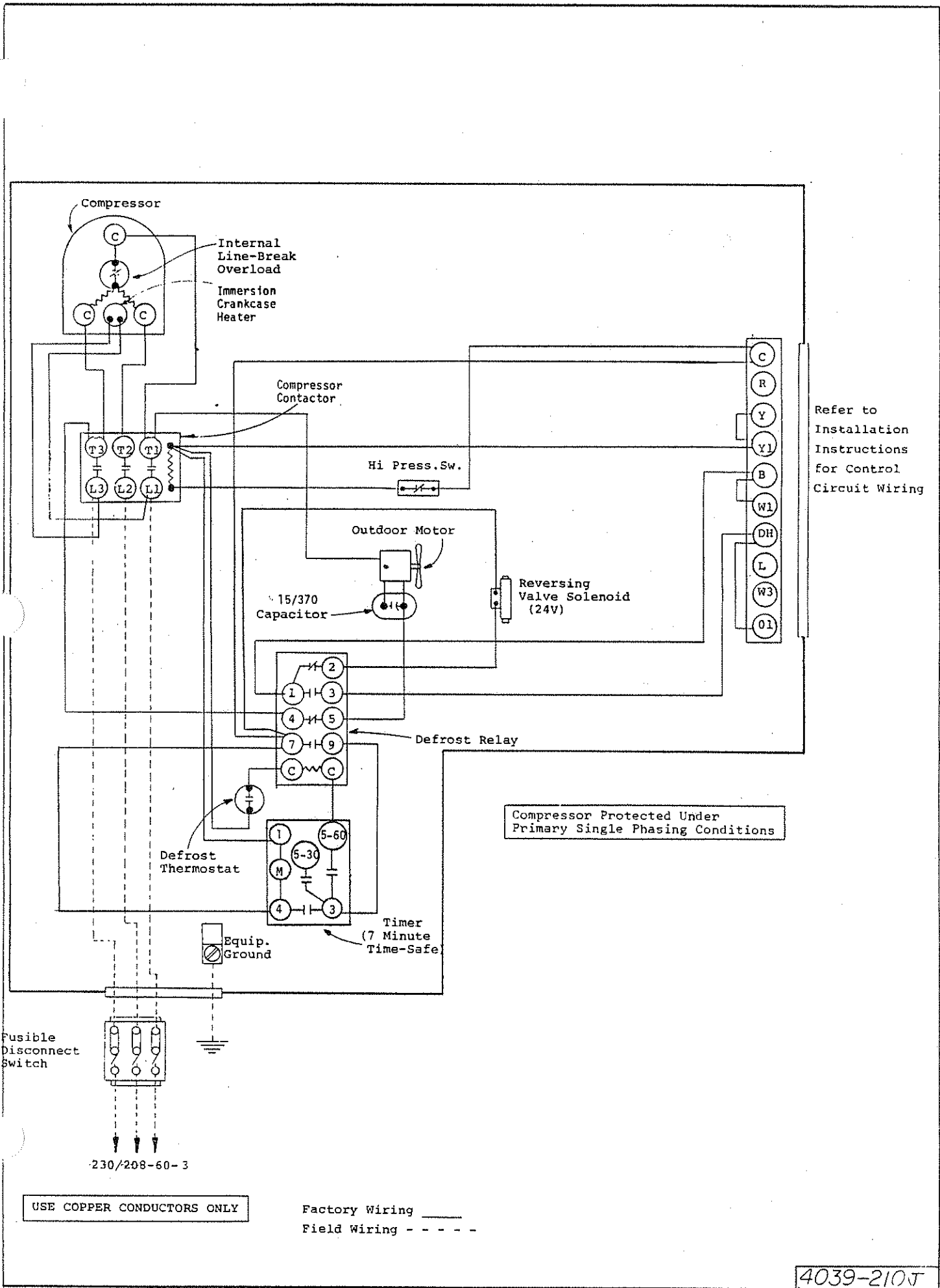

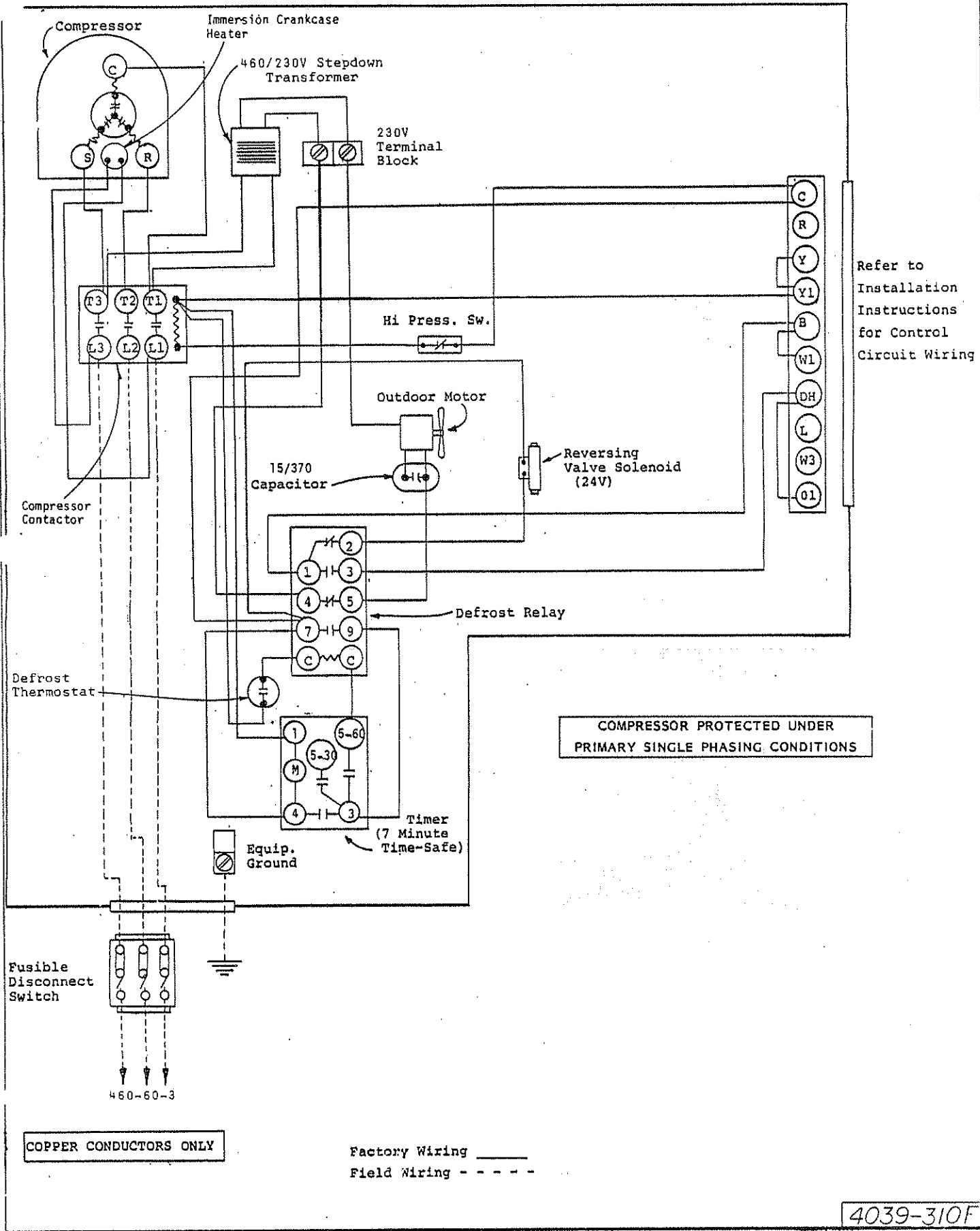

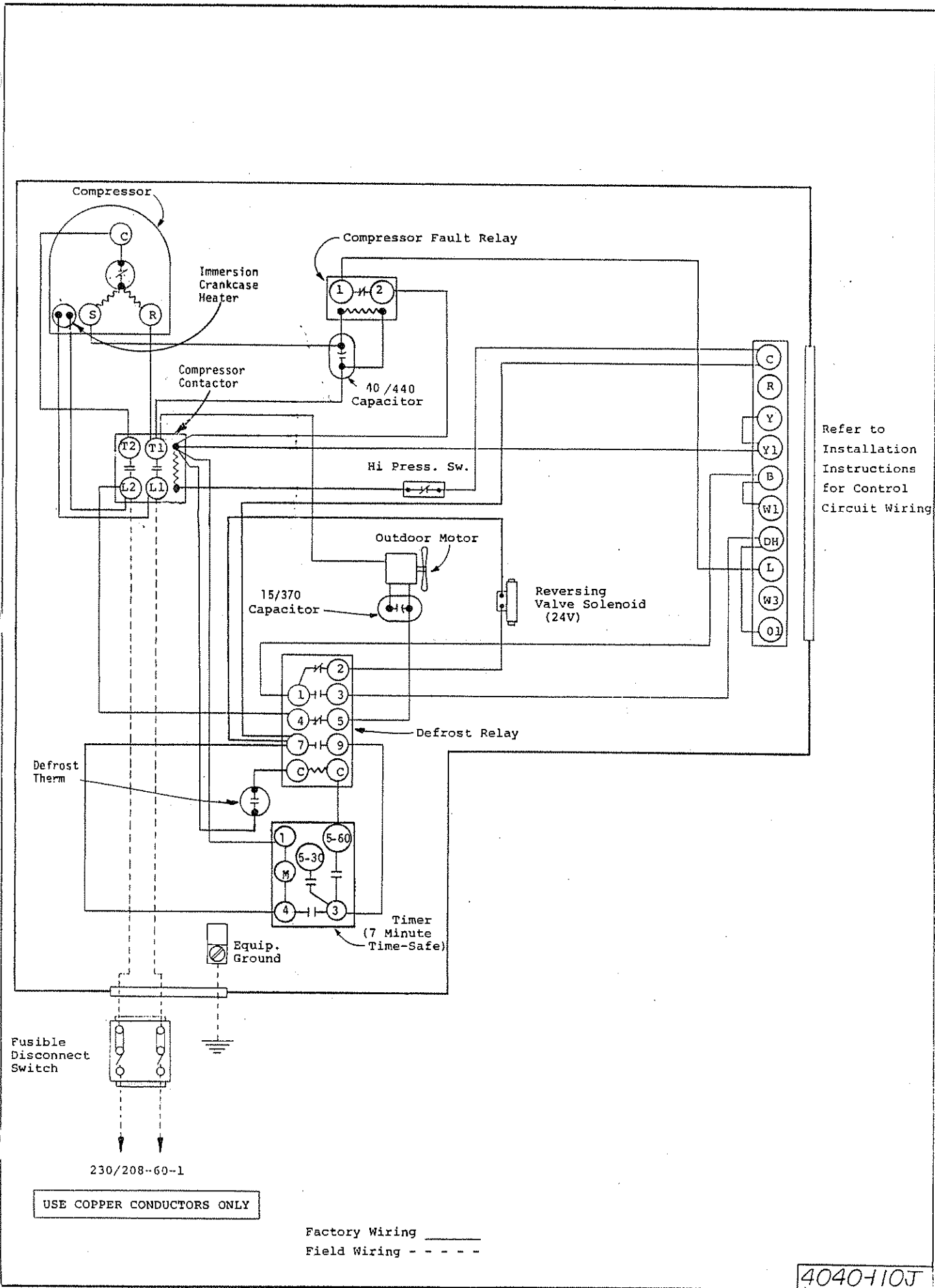

Refer to  
Installation  
Instructions  
for Control  
Circuit Wiring

USE COPPER CONDUCTORS ONLY

Factory Wiring \_\_\_\_\_  
Field Wiring - - - - -

4040-110J

230/208-60-1

Fusible  
Disconnect  
Switch

Equip.  
Ground

Timer  
(7 Minute  
Time-Safe)

Defrost Relay

Reversing  
Valve Solenoid  
(24V)

15/370  
Capacitor

Outdoor Motor

Hi Press. Sw.

40/440  
Capacitor

Immersion  
Crankcase  
Heater

Compressor  
Contactor

Compressor

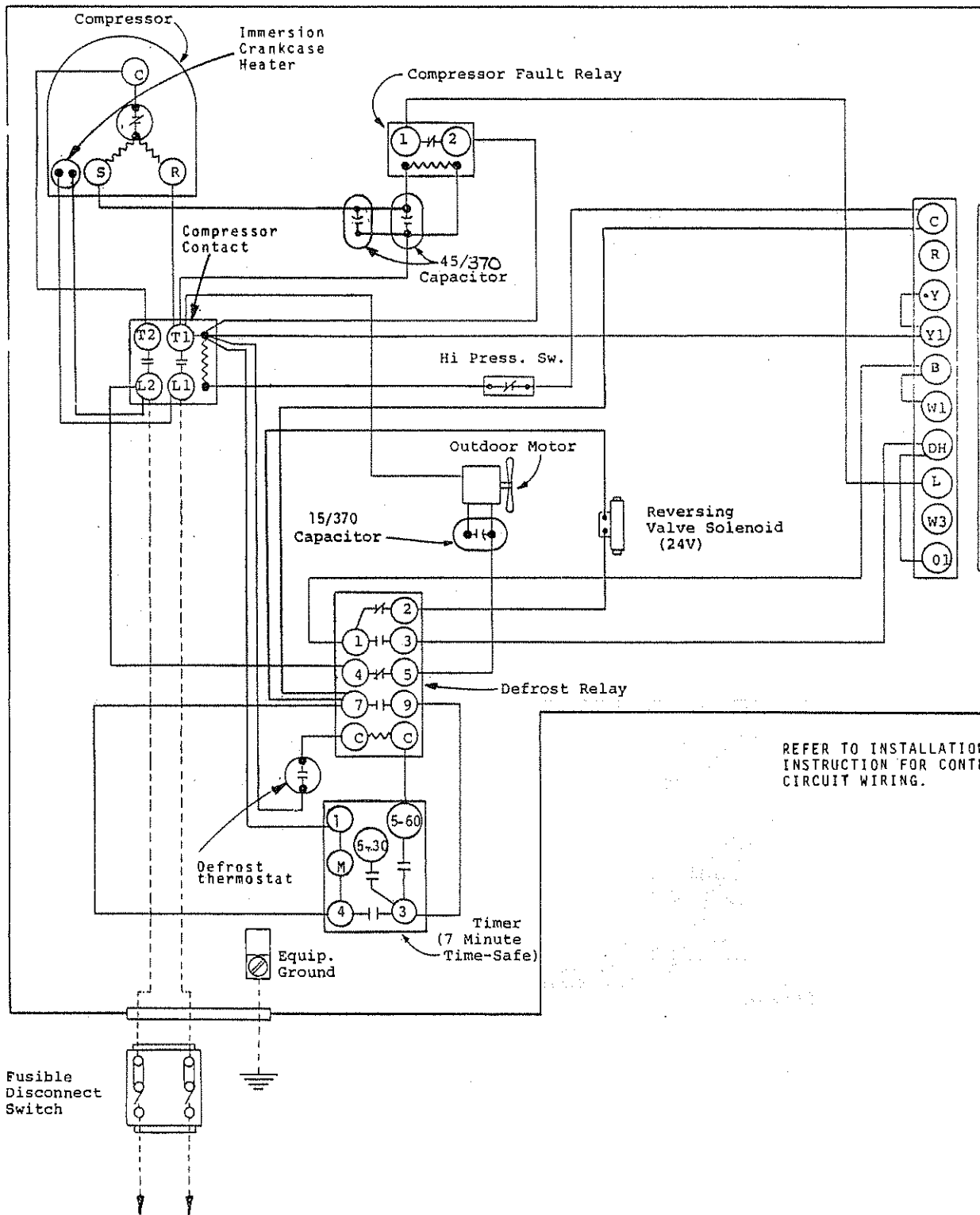

REFER TO INSTALLATION INSTRUCTION FOR CONTROL CIRCUIT WIRING.

Fusible Disconnect Switch

230/208-60-1

USE COPPER CONDUCTORS ONLY

Factory Wiring \_\_\_\_\_  
 Field Wiring - - - - -



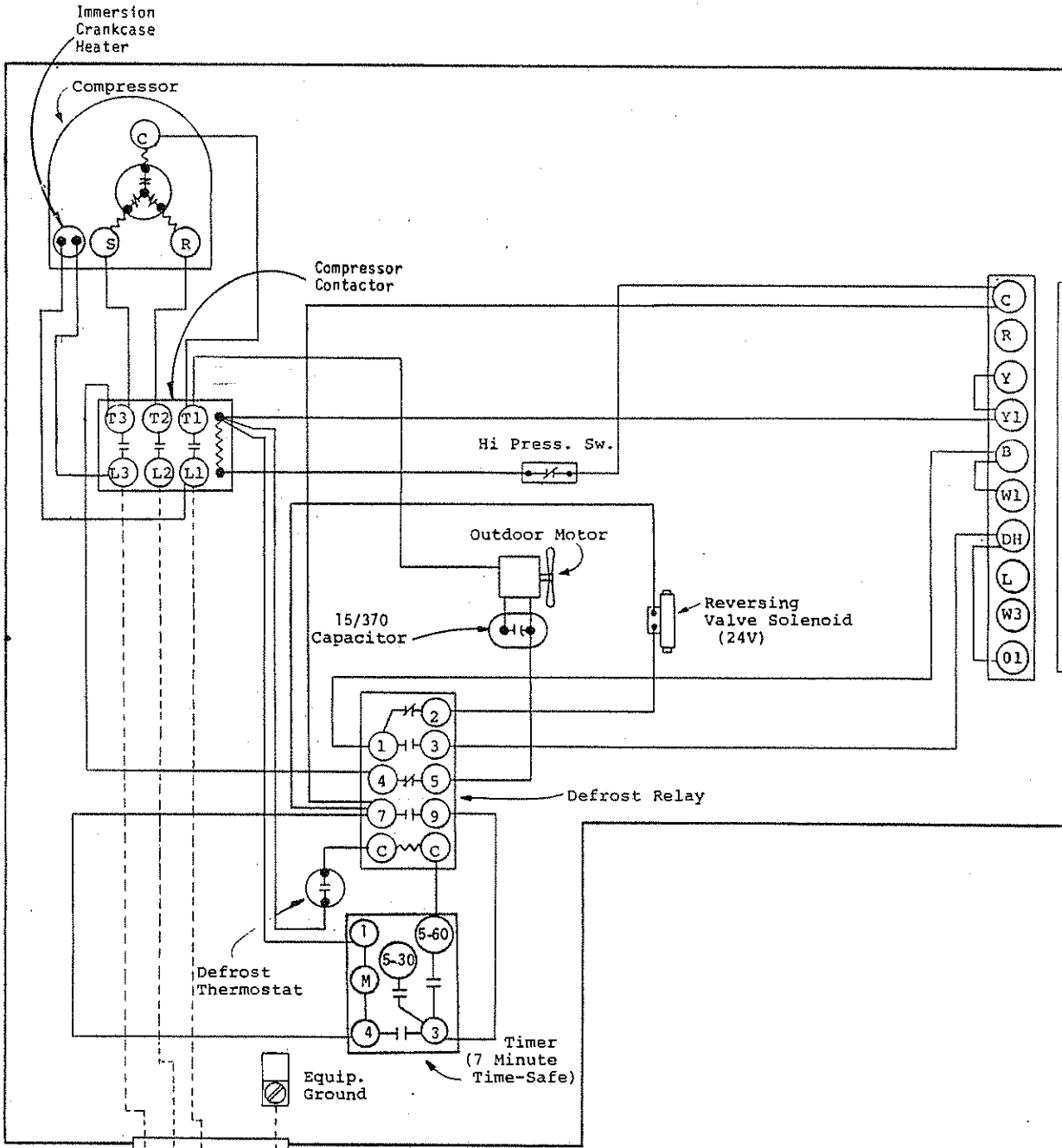

Refer to  
Installation  
Instructions  
for Control  
Circuit Wiring

Fusible  
Disconnect  
Switch

230/208-60-3

COPPER CONDUCTORS ONLY

Factory Wiring \_\_\_\_\_  
Field Wiring - - - - -

4040-210J

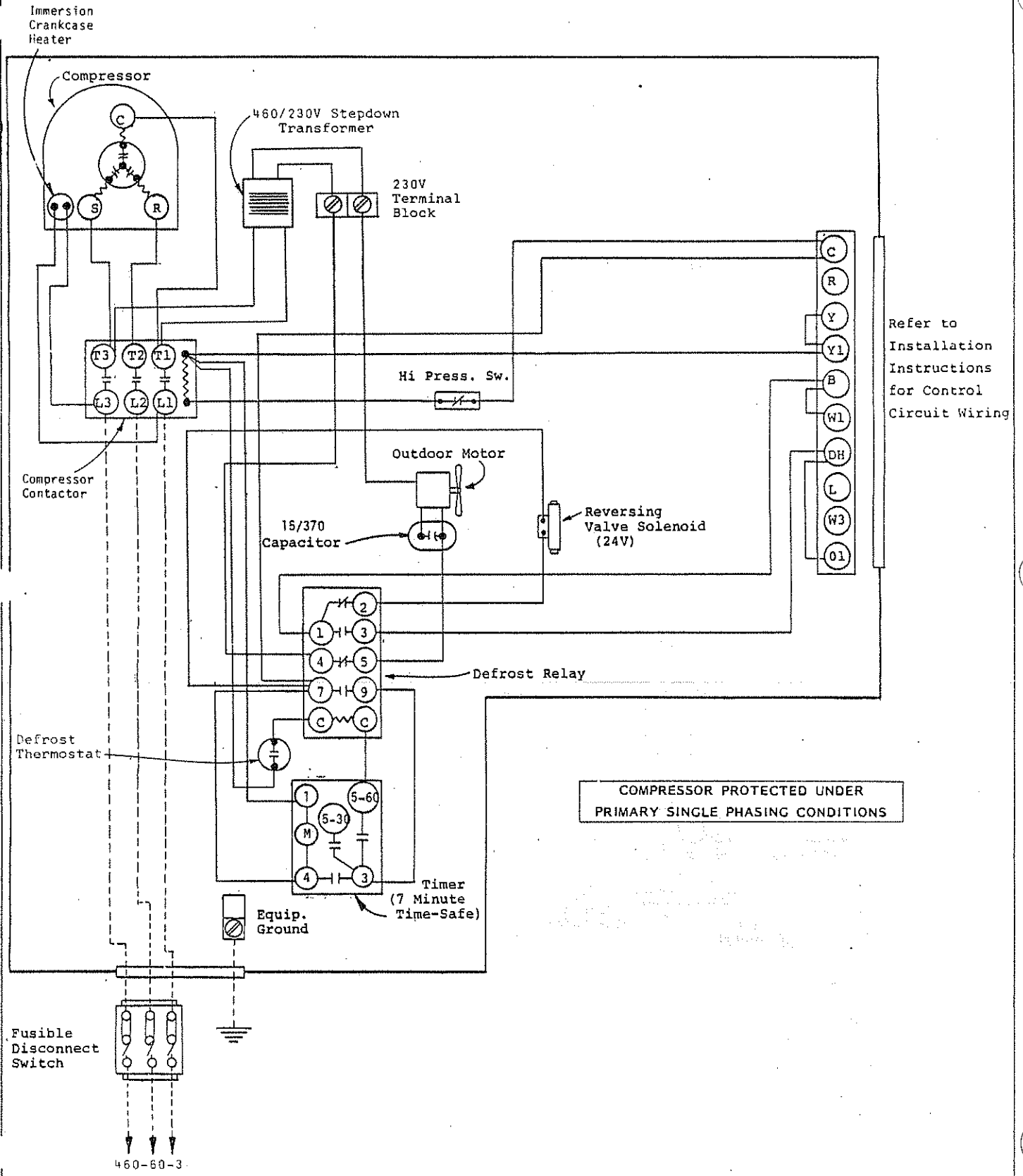

Refer to  
Installation  
Instructions  
for Control  
Circuit Wiring

COMPRESSOR PROTECTED UNDER  
PRIMARY SINGLE PHASING CONDITIONS

COPPER CONDUCTORS ONLY

Factory Wiring \_\_\_\_\_  
Field Wiring - - - - -