

MANUAL 2100 - 026A



MODELS
B48EHQ and B60EHQ

INDOOR BLOWER COIL UNIT

INSTALLATION INSTRUCTIONS

FOR USE WITH:
BARD SPLIT HEAT PUMP AND
SPLIT AIR CONDITIONER SYSTEMS

BARD MANUFACTURING CO. • BRYAN, OHIO 43506

Dependable quality home equipment... since 1914

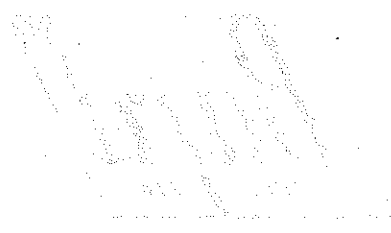

100 100

100 100 100 100

100 100 100 100

100 100 100 100

100 100

100 100 100 100

100 100 100 100

B-EHQ SERIES

3-1/2 TO 5 TON (NOMINAL)

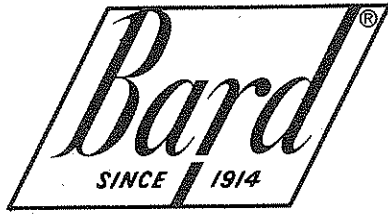

- Built-In Electric Heating 5-35Kw (230V)
- Direct Drive Multispeed Motor (230V)
- Slide-In Return Air Filter
- Upflow - Downflow - Horizontal

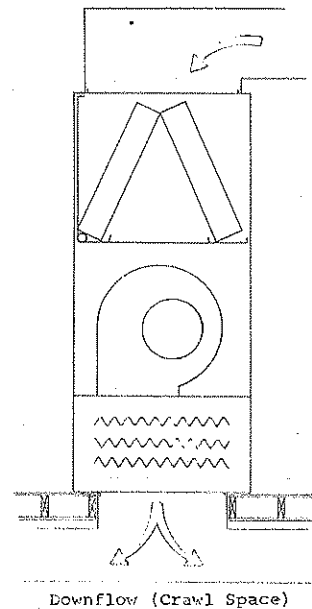
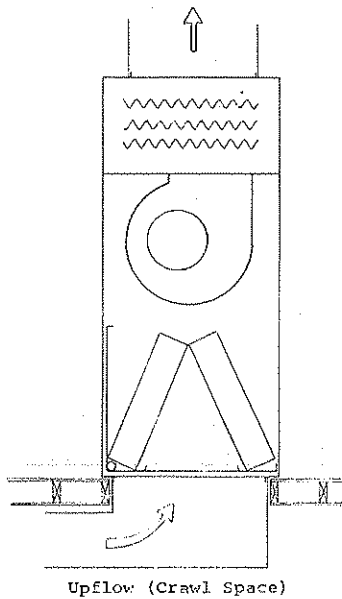
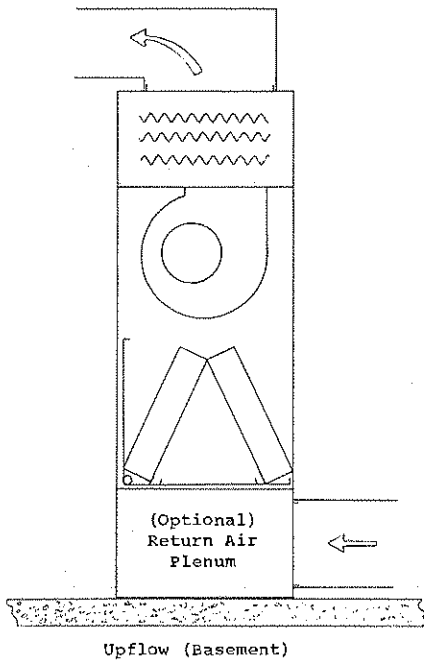
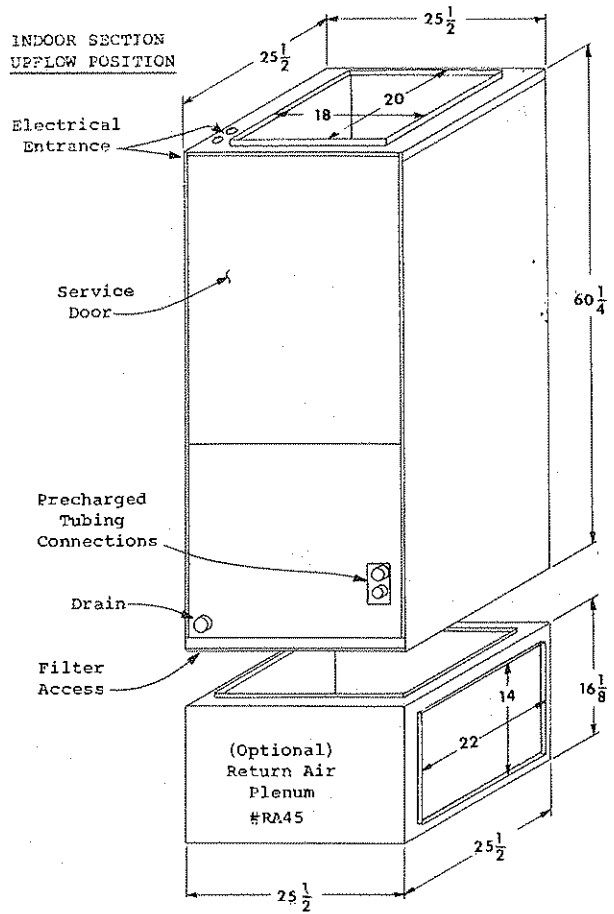
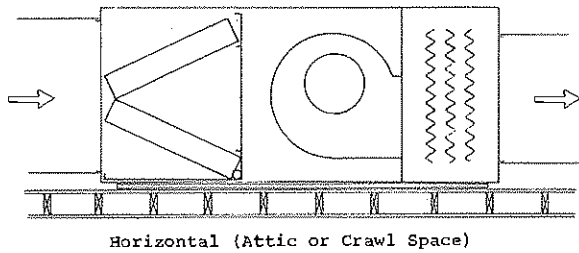

AIRFLOW PERFORMANCE DATA

MAXIMUM E.S.P. INFORMATION*						
Type of Application	Rating of Electric Heaters		MODEL B48EHQ		MODEL B60EHQ	
			High	Low	High	Low
Heat Pump Alone or Heat Pump In Conjunction With Electric Heat	35	1 Ph	--	--	--	--
	30	1 Ph	--	--	--	--
	25	1 Ph	--	--	--	--
	20	1 Ph	.6	.5	.7	.6
	15	1 Ph	.6	.5	.7	.6
	10	1 Ph	.6	.5	.7	.6
	36	3 Ph	--	--	--	--
	30	3 Ph	--	--	--	--
	27	3 Ph	--	--	--	--
	24	3 Ph	--	--	--	--
	21	3 Ph	--	--	--	--
	18	3 Ph	.6	.5	.7	.6
	15	3 Ph	.6	.5	.7	.6
	12	3 Ph	.6	.5	.7	.6
	9	3 Ph	.6	.5	.7	.6
Heat Pump In Emergency Heat Mode (Electric Heat Only Or Air Cond	35	1 Ph	--	--	.7	.6
	30	1 Ph	.6	.5	.7	.6
	25	1 Ph	.6	.5	.7	.6
	20	1 Ph	.6	.5	.7	.6
	15	1 Ph	.6	.5	.7	.6
	10	1 Ph	.6	.5	.7	.6
	36	3 Ph	--	--	.7	.6
	30	3 Ph	.6	.5	.7	.6
	27	3 Ph	.6	.5	.7	.6
	24	3 Ph	.6	.5	.7	.6
	21	3 Ph	.6	.5	.7	.6
	18	3 Ph	.6	.5	.7	.6
	15	3 Ph	.6	.5	.7	.6
	12	3 Ph	.6	.5	.7	.6
	9	3 Ph	.6	.5	.7	.6

*Values shown are for standard bottom return opening mounted in the vertical position. Reduce the E.S.P. shown by .10 with #RA45 return air plenum installed. Reduce the E.S.P. shown by .05 for horizontal and counterflow installations.

BLOWER COIL PERFORMANCE				
CFM DRY COIL WITH FILTER				
E.S.P. Inches H ₂ O	B48EHQ		B60EHQ	
	High	Low	High	Low
.00	1925	1740	2200	1865
.10	1880	1675	2160	1845
.20	1820	1600	2115	1825
.30	1750	1525	2070	1800
.40	1675	1435	2025	1770
.50	1600	1335	1875	1740
.60	1500	--	1925	1700
.70	1380	--	1875	1650

MAXIMUM ALLOWABLE AIRFLOW RANGE

B48EHQ 1335 to 1750 CFM

B60EHQ 1700 to 2100 CFM

RATED CFM

1625

2000

Model	Volts/PH	Heater Kw @ 240V	Max. Unit Amps	Heater Amps	Internal Fuses		Required Max. External Fuses		Minimum Ckt. Ampacity		Power Ckt. Wiring Δ		Ground Wire Size Δ	
					Ckt. A	Ckt. B	Ckt. A	Ckt. B	Ckt. A	Ckt. B	Ckt. A	Ckt. B	Ckt. A	Ckt. B
B48EHQ	240/1	0	4.4				15		15		14		14	
		10	46	41.6			60		58		4		10	
		15 Δ	66.9	62.5	60/30		90		84		2		8	
		20	87.6	83.2	60/60		110		110		2		6	
		25	108.6	104.2	60	60/30	60	80	58	78	4	3	10	8
		30	129.4	125.0	60	60/60	60	110	58	104	4	2	10	6
	240/3	0	4.4				15		15		14		14	
		9	26.1	21.7			35		33		8		10	
		12	33.3	28.9			45		42		6		10	
		15	40.5	36.1			60		51		6		10	
		18 Δ	47.6	43.2			60		60		4		10	
		21	54.9	50.5	35/40		70		69		4		8	
B60EHQ	240/1	0	6.4				15		15		14		14	
		10	48	41.6			60		60		4		10	
		15	68.9	62.5	60/30		90		86		2		8	
		20 Δ	89.6	83.2	60/60		125		112		2		6	
		25	110.6	104.2	60	60/30	60	80	60	78	4	3	10	8
		30	131.4	125.0	60	60/60	60	110	60	104	4	2	10	6
	240/3	0	6.4				15		15		14		14	
		9	28.1	21.7			35		35		8		10	
		12	35.3	28.9			45		44		6		10	
		15	42.5	36.1			60		53		6		10	
		18 Δ	49.6	43.2	35/30		70		62		4		8	
		21	56.9	50.5	35/40		80		71		3		8	
240/1	24	64.2	57.8	45/40		80		80		3		8		
	27	71.4	65.0	45/45		90		89		2		8		
	30	78.6	72.2	60/45		100		98		1		8		

Δ Suggested size based on use of 60°C wiring material for ampacities less than 100A and 75°C wiring material for ampacities greater than 100A.

Δ Based upon Table 250-95 °F 1978 N.E.C.

Δ Maximum of 20Kw 1 phase and 18Kw 3 phase operates in conjunction with heat pump. Any installed Kw above these amounts operates during emergency heat operation. See page 6 for additional information.

GENERAL

Units are shipped completely assembled and internally wired, requiring only duct connections, thermostat wiring and external 208-240 volt AC power supply.

The B48EHQ and B60EHQ blower coil units, with various Kw electric heat options are suitable for use with the following air conditioner and heat pump outdoor sections. It can be used both as an air conditioning system with electric heat and as a heat pump with electric heat. Refer to sections titled, Air Conditioning With Electric Heat and Heat Pump With Electric Heat for complete information.

APPROVED COMBINATIONS

<u>Air Conditioning</u>		<u>Heat Pump</u>	
<u>Outdoor Section</u>	<u>Indoor Section</u>	<u>Outdoor Section</u>	<u>Indoor Section</u>
42ECQ	B48EHQ	42HPQ	B48EHQ
48ECQ1	B48EHQ	48HPQ2	B48EHQ
60ECQ1	B48EHQ	60HPQ3	B60EHQ

IMPORTANT NOTE: The B60EHQ is matched only with the 60HPQ3 outdoor heat pump unit. Matching the B60EHQ with 60ECQ1 outdoor air conditioning unit actually results in 1000 Btuh loss and increased power consumption over approved combination as shown above.

UNPACKING

Upon receipt of equipment, carton should be checked for external signs of damage. If damage is found, request for inspection by carrier's agent should be made in writing immediately.

SIZING

Size of unit for a proposed installation should be based on heat loss calculation made according to methods of National Warm Air Heating and Air Conditioning Association. The air duct should be installed in accordance with the Standards of the National Fire Protection Association for the Installation of Air Conditioning and Ventilating Systems of Other Than Residence Type, NFPA No. 90A, and Residence Type Warm Air Heating and Air Conditioning Systems, NFPA No. 90B. Where local regulations are at a variance with instructions, installer should adhere to local codes.

MOUNTING POSITIONS

The B48EHQ and B60EHQ can be installed in three positions with respect to airflow direction: Upflow, horizontal and downflow. The general intent of these mounting positions is shown on the cover page of this installation manual.

Return air plenum RA45 is required for upflow installations (unless a crawl space or similar installation with return air duct beneath unit mounting surface). The RA45 plenum is square in design and the 14" x 22" duct flange can be positioned as desired for ease of installation.

The unit is shipped with the coil installed for upflow mounting position. It is secured in place by two screws, one at each bottom front corner of the slide support angles. A coil shipping bracket is installed at the top left of the angled coil drain pan (unit in upflow position, looking at coil access opening), secured by one screw. To convert to either horizontal or downflow position, remove front access panel, remove two screws securing coil pan assembly, remove shipping bracket, and remove coil.

Place cabinet in desired mounting position, and reinstall coil as shown on cover page. Make sure the coil is installed as shown with respect to blower. It is not necessary to reinstall shipping bracket or the two securing screws thru the slide angles.

IMPORTANT: The unit as received has coil installed for upflow position only. It must be rotated 180° for both horizontal and downflow positions. See Note under "Condensate Drain."

DUCTWORK

Design the ductwork according to methods given by the National Warm Air Heating and Air Conditioning Association. When duct runs through unheated spaces, it should be insulated with a minimum of two inches of insulation. Use insulation with a vapor barrier on the outside of the insulation. Flexible joints should be used to connect the ductwork to the equipment in order to keep the noise transmission to a minimum.

FILTER

These units come equipped with a 24" x 24" x 1" thick disposable fibreglas filter and must not be operated without a filter in place. Filter access is gained by removing an angle piece located at the bottom of the main unit cabinet (as viewed in upflow position), just above the RA45 plenum location - if utilized.

The filter should be replaced periodically throughout the year, as these are year-round heat-cool systems. Special attention should be given to filter cleanliness on any new installation, as airborne dust and debris from recent construction can easily plug a filter in a matter of days.

Dirty filters are the most prevalent and most easily corrected problem to be encountered in any forced air heating and/or cooling system.

LOCATION AND CLEARANCES

All access to the equipment is from one side, and at least 24 inches should be provided from this side for service access.

Unit casing is suitable for 0 inch clearance. The first four (4) feet of ductwork attached to the outlet (supply air) connections of the unit are to have a minimum of 1 inch clearance, with 0 inch clearance for any remaining ductwork.

CONDENSATE DRAIN

Determine where the drain line will run. This drain line contains cold water and must be insulated to avoid drops of water from dropping on ceiling, etc. A trap must be installed in the primary drain line below the bottom of the drain pan.

For horizontal installations with auxiliary drain pan, a separate drain line should be run from the auxiliary drain pan and terminated where the homeowner can see it. Be certain to show the homeowner the location of the drain line and to explain its purpose. In the event of overflow of primary drain, water will collect in auxiliary pan and run out through the auxiliary drain line.

It is not recommended that any condensate drain lines be connected to a sewer main. Drain lines must be installed in accordance with local codes.

When installed horizontal in an attic installation, a platform should be made for the unit to sit on. This platform can be made from 3/4 inch plywood or boards. An auxiliary drain pan should always be used when equipment is installed over a finished living area, to provide protection from water damage in case of plugging of the primary drain line from the unit condensate collection pan.

Secure four pieces of cork or live rubber, 4" x 4", of sufficient thickness to allow primary drain to clear edge of auxiliary drain pan, under each corner of the unit.

NOTE: There is a 3/8" copper tube brazed on an angle thru the coil drain pan approximately 2" from the 3/4" main drain pipe coupling. This is an overflow drain to control the point at which water would exit the drain pan in the event the primary drain becomes plugged. When the coil assembly is removed and reinstalled for downflow, make sure the 3/8" drain overflow tube extends slightly beyond the coil door when in place.

INTERCONNECTING TUBING

It is recommended that the interconnecting tubing be the CT-12 series charged tubing sets. This is a precharged tubing set with an insulated suction line. Both suction and liquid line are equipped with the correct quick connect fittings for proper match up to the indoor and outdoor sections. The CT-12 series is available in standard tubing lengths of 15, 25, 35 and 45 feet.

THERMOSTAT LOW-VOLTAGE WIRING

A 24V terminal block is mounted on the inside of the unit. There is also a 24V terminal block located in the outdoor section of remove heat pumps and two tagged 24V wires in the outdoor section of remove air conditioners.

Specific control circuit wiring diagrams for the various applications are referenced in the sections titled AIR CONDITIONING WITH ELECTRIC HEAT and HEAT PUMP WITH ELECTRIC HEAT. These diagrams detail the recommended controls and wiring to allow the best possible operation of the different types of systems with respect to energy conservation while still maintaining close comfort levels for the occupant.

TRANSFORMER, HEAT-COOL BLOWER RELAY, FUSING

The B48EHQ and B60EHQ are provided with a 65VA transformer. The transformer is protected by a 3 Amp fuse located in the 24V terminal block compartment and wired into the transformer secondary.

A heat-cool blower relay is installed to provide blower operation automatically with any thermostat demand for heating or cooling, or can be operated continuously for air circulation on command from the thermostat fan switch.

All single phase models with 15Kw or higher and all three phase models with 18Kw or higher are internally fused and sub-divided. See electrical data tables for more information.

UNIT OPERATION

The controls in the B48EHQ and B60EHQ provide for manual/auto blower operation in addition to the staging of the installed electric heat. The table below lists the stages by Kw breakdown for both air conditioning and heat pump installations.

IMPORTANT NOTE: A maximum of 20Kw, 1-Ph and 18Kw, 3-Ph can be operated in conjunction with heat pump. Larger Kw's can be installed as shown below, but will function only during defrost cycle, emergency heat operation, or periods of compressor cut-off, if used.

TWO SPEED BLOWER MOTOR

The B48EHQ and B60EHQ both have a two-speed blower motor, but they are different motors. The B48EHQ has a 1/2 hp motor and the B60EHQ has a 3/4 hp motor.

Motor lead wire identification is the same for both motors:

- Common - Yellow
- High - Black
- Low - Red
- Capacitor - Brown (2)

Both models are shipped wired on high speed. The unused red (low speed) lead wire is taped off. If low speed operation is desired, remove and tape black wire from terminal 6 on blower relay and connect red wire to terminal 6. Refer to wiring diagrams for electrical circuitry and to airflow charts for capabilities and limitations on blower speeds, static pressures and air delivery vs. installed Kw heaters.

BLOWER MOTOR OILERS

The blower motors should be oiled twice a year with approximately 8-10 drops of 20 weight motor oil. DO NOT over-oil and DO NOT use 3-in-1 oil or any other light oil.

IMPORTANT NOTE FOR DOWNFLOW INSTALLATION: Loosen belly-band bolt securing motor enough to rotate motor so oilers are above either 3 or 9 o'clock position so oilers do not drain and to permit reoiling.

CONTROL STAGES BY HEATER KW									
Model	Total Kw	PH	Matched With A/C			Matched With Heat Pump			
			Wall Stat		O.D.Stat	Wall Stat		O.D.Stat	Em. Heat
			1st St.	2nd St.		1st St.	2nd St.		
B48EHQ & B60EHQ	10	1	10	--		H.P. ²	10 ⁶		
	15	1	10	5		H.P.	15 ⁷		
	20	1	10	10		H.P.	20 ⁴	⁴	
	25	1	10	10	5 ³	H.P.	20 ⁴	⁴	5 ³
	30	1	10	10	10 ³	H.P.	20 ⁴	⁴	10 ³
	35 ¹	1	10	10	15 ³	H.P.	20 ⁴	⁴	15 ³
	9	3	9	--		H.P.	9 ⁶		
	12	3	12	--		H.P.	12 ⁶		
	15	3	15	--		H.P.	15 ⁶		
	18	3	9	9		H.P.	9	⁸	9 ⁵
	21	3	9	12		H.P.	9		12 ⁵
	24	3	12	12		H.P.	12		12 ⁵
	27	3	12	15		H.P.	12		15 ⁵
	30	3	15	15		H.P.	15		15 ⁵

- ¹ Model B60EHQ Only.
- ² Heat pump is always 1st stage.
- ³ If O.D. stat is not used, 24V terminals DH and O1 must be connected together. The Kw shown under O.D. stat will then cycle with 2nd stage.
- ⁴ If one O.D. stat is used, 10Kw will switch from 2nd stage to O.D. stat, leaving only 10Kw on 2nd stage. This is normally recommended.
- ⁵ This amount of heat also cycles on during brief defrost cycles.
- ⁶ If 2nd stage wall stat is not calling for heat, this amount of Kw will automatically come on during defrost cycles.
- ⁷ If 2nd stage wall stat is not calling for heat, 5Kw will automatically come on during defrost.
- ⁸ To operate all 18Kw with H.P., use one O.D. stat.

AIR CONDITIONING WITH OR WITHOUT SUPPLEMENTAL ELECTRIC HEAT

When the B48EHQ or B60EHQ are marched with the approved outdoor air conditioning sections, different thermostats may be required depending on installed Kw and desired staging. Listed below are the "Recommended" wall thermostats, sub-bases, number of outdoor stats, and number of 24V wires required.

Model	Kw	PH	Bard No.	Description	Bard No.	Description	No. of Outdoor Thermostats	No. of 24V Stat to I.D. Unit	Wires Required I.D. Unit to O.D. Unit
B48EHQ and B60EHQ	0	1	8403-001	T87F2055	8404-003	Q539A1147		3	2
	10	1	"	"	"	"		4	2
	15	1	8403-004	T872C1004	8404-005	Q672A1005		5	2
	20	1	"	"	"	"		5	2
	25	1	"	"	"	"	1	5	4
	30	1	"	"	"	"	1	5	4
	35 ¹	1	"	"	"	"	1	5	4
	0	3	8403-001	T87F2055	8404-003	Q539A1147		3	2
	9	3	"	"	"	"		4	2
	12	3	"	"	"	"		4	2
	15	3	"	"	"	"		4	2
	18	3	8403-004	T872C1004	8404-005	Q672A1005		5	2
	21	3	"	"	"	"		5	2
	27	3	"	"	"	"		5	2
	30	3	"	"	"	"		5	2

¹ 35Kw, 1 Ph on B60EHQ only.

² Part No. 8408-001 Adjustable range + 10 to 45°F.
8408-005 Adjustable range 0 to +30°F.
These are field installed in outdoor section.

HEAT PUMP WITH SUPPLEMENTAL ELECTRIC HEAT

The system and its safety controls are designed in such a manner that the heat pump and a maximum of 20Kw, 1 ph and 18Kw, 3 ph can operate simultaneously. Larger Kw's can be installed, however, and are controlled by the emergency heat switch and/or field installed compressor cut-off. This allows for "total" heating capability in case of a malfunction in the outdoor heat pump unit.

Listed below are the thermostats required for use with these heat pump models. It is essential that one or the other of these thermostat and sub-base combinations be used because the internal wiring of both the heat pump unit and the thermostat are specially designed for one another.

Model	Kw	Ph	Thermostat & Subbase Combination	No. of Outdoor Thermostats	No. of 24V Wires Req'd.	
					Stat to I.D. Unit	I.D. Unit to O.D. Unit
B48EHQ & B60EHQ	0	1	A or B		5	5
	10	1	"		8	6
	15	1	See Chart	$\begin{matrix} \uparrow \\ \uparrow \\ \uparrow \\ \uparrow \\ \uparrow \\ \uparrow \end{matrix}$	9	8
	20	1	Next Column		9	8
	25	1	"		9	8
	30	1	"		9	8
30	1	"	9		8	
35 ¹	1	"	9		8	
	0	3	A or B		5	5
	9	3	"		8	6
	12	3	See Chart	$\begin{matrix} \uparrow \\ \uparrow \\ \uparrow \\ \uparrow \\ \uparrow \\ \uparrow \end{matrix}$	8	6
	15	3	Next Column		9	8
	18	3	"		9	8
	21	3	"		9	8
	24	3	"		9	8
	27	3	"		9	8
	30	3	"	9	8	

¹ 35Kw 1 ph on B60EHQ only.

² Part No. 8408-001 Adjustable range +10 to +45°F.
8408-005 Adjustable range 0 to +30°F.
These are field installed in outdoor section.

³ Compressor cut-off recommended for all climate areas that experience sub-zero temperatures. Add one (1) additional 8408-005 to total if this applies.

⁴ All electric heat cycles on 2nd stage of wall stat as wired at factory. The last 5, 10 and 9Kw for 15, 20 and 18Kw models respectively can be held off by using one (1) outdoor stat. This is optional--see CCD4260-7.

⁵ One outdoor thermostat should be used to keep 1st 20Kw from cycling together on stage 2 of wall stat. The 5, 10 or 15Kw cycles on only during emergency heat, compressor cut-off, or defrost cycle. See CCD4260-8.

WALL THERMOSTAT AND SUB-BASE COMBINATIONS			
Group	Thermostat	Subbase	Predominant Feature
A	8403-012 (T872R1164)	8404-007 (Q672L1185)	Heat or Cool - No Auto ¹
B	8403-015 (T872N1036)	8404-008 (Q672F1299)	Automatic Heat-Cool Changeover Position ²

¹ No automatic changeover position--must manually place in heat or cool. Reversing valve remains energized at all times system switch is in heat position (except during defrost cycle). No pressure equalization noise when thermostat is satisfied on either heating or cooling.

² Allows thermostat to control both heating and cooling operation when set in "auto" position. Reversing valve de-energizes at end of each "on" heating cycle.

IMPORTANT NOTE: Both thermostat and sub-base combinations shown above incorporate the following features: Man-auto fan switch, Off-Heat-Cool-Em. Ht. switch, and two (2) indicator lamps—one for Em. Ht. and one for compressor malfunction.

THERMOSTAT INDICATOR LAMPS

The red lamp marked "Em. Ht." comes on and stays on whenever the system switch is placed in the Em. Ht. position. The green lamp marked "check" will come on if there is any problem that prevents the compressor from running when it is supposed to be.

EMERGENCY HEAT POSITION

The operator of the equipment must manually place the system switch in this position. This is done when there is a known problem with the outdoor section, or when the green "check" lamp comes on indicating a problem.

COMPRESSOR MALFUNCTION RELAY

Actuation of the green "check" lamp is accomplished by a voltage type relay which is factory installed and located in the outdoor unit on 1 ph units only. The compressor malfunction relay is optional and must be field installed on all matching 3 ph outdoor units.

THERMAL CUT OFFS AND LIMIT CONTROL

A thermal cut-off is installed for each 3, 4 or 5Kw segment of the installed electric heaters (9Kw = 3-3Kw, 15Kw = 3-5Kw, etc.) These are a back-up safety device to the primary safety—the Hi-Limit control. The thermal cut-offs are located in the heater mounting plate in the control compartment, and are a one-shot device. They must be replaced with an identical part should they function.

The Hi-Limit control is an automatic reset device and controls the operation of the electric heaters during any abnormal condition: Dirty filters, closed registers, defective blower motor, etc.

Access to the limit control is gained by removing a 6" x 8" plate, secured by four (4) screws. This plate is attached to the blower deck to the left of the blower housing (when viewing the unit in upflow position from access panel side). It is not absolutely necessary, but desirable, to remove the blower housing for easiest access.

CONTROL CIRCUIT WIRING DIAGRAMS

To aid the installer in making the 24V control circuit connections for all the Kw and phase variations, and also to show "Recommended" installations of outdoor thermostat and compressor cut-off options, a series of control circuit wiring diagrams are included in this manual. These diagrams depict the low voltage terminal boards located in the indoor and outdoor sections, and the respective wall thermostats and sub-bases necessary to accomplish the required control functions.

The table below lists, by Kw and phase, the appropriate control circuit diagram (CCD) number. The diagrams are located on page 7 of this manual.

CONTROL CIRCUIT WIRING DIAGRAMS			
Type	Total Kw	Phase	CCD No.
A/C	0	1 or 3	CCD4260-1
	10	1	CCD4260-2
	15, 20	1	CCD4260-3
	25, 30, 35 [⚠]	1	CCD4260-4
	9, 12, 15	3	CCD4260-2
	18, 21, 27, 30	3	CCD4260-3
H.P.	0	1 or 3	CCD4260-5
	10	1	CCD4260-6
	15, 20	1	CCD4260-7
	25, 30, 35 1	1	CCD4260-8
	9, 12, 15	3	CCD4260-6
	18	3	CCD4260-7
	21, 27, 30	3	CCD4260-6

[⚠] 35Kw 1 ph on model B60EHQ only.

THERMOSTAT HEAT ANTICIPATION

Some of the wall thermostats require setting of the heat anticipator to assure proper cyclic operation and good temperature control within the structure being heated and cooled. Other anticipators are fixed and require no adjustment. The table below summarizes the anticipator types and their ranges, if adjustable.

Bard No.	Description	Stage	Type	Range	Stage	Type
8403-001	T87F2055	1	Adj.	.10-1.2A	1	Fixed
8403-004	T872C1004	1	Adj.	.10-1.2A	1	Fixed
		2	Adj.	.10-1.2A	1	Fixed
8403-012	T872R1164	1	Adj.	.10-1.2A	1	Fixed
		2	Fixed	—	—	—
8403-015	T872N1036	1	Adj.	.10-1.2A	1	Fixed
		2	Fixed	—	—	—

[⚠] Both of these thermostats have a W2 and a W3 connection terminal that are controlled by the 2nd stage mercury switch. W2 is connected to the fixed anticipator and W3 by-passes the anticipator, thus allowing outdoor thermostat operation without disrupting cycling rate, etc.

DOWNFLOW (COUNTERFLOW) INSTALLATION

A B48EHQ-B60EHQ combustible floor base is required for downflow installations to assure a 1" clearance from combustible materials to the outlet plenum (duct).

A 20½" x 22½" opening is required in the floor (mounting surface). See illustrations.

The B48EHQ-B60EHQ combustible floor base must be ordered separately. It is not included as part of the basic unit.

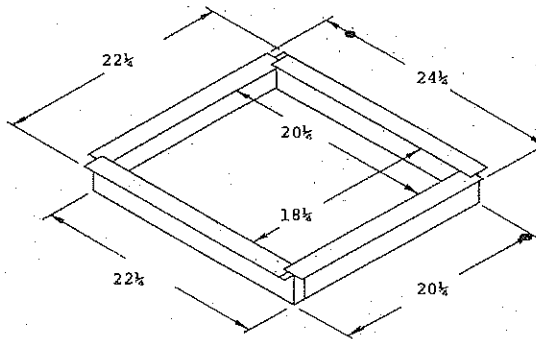
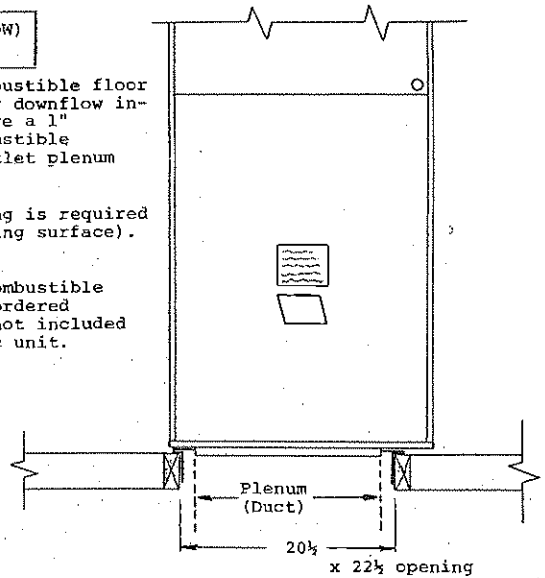

AIR CONDITIONING CONTROL CIRCUIT WIRING DIAGRAMS

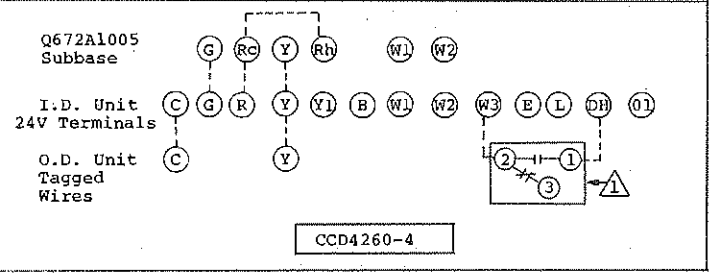
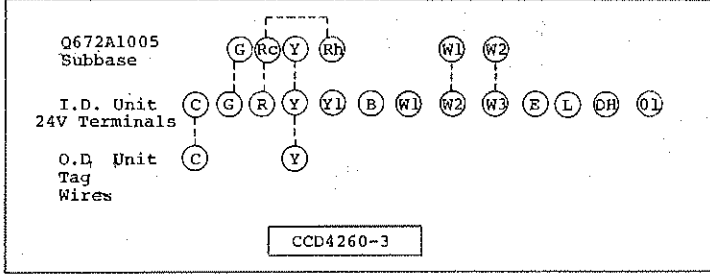
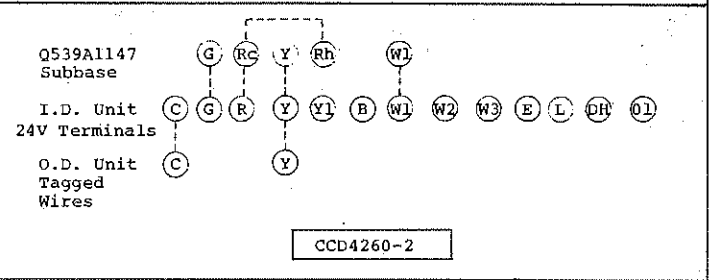
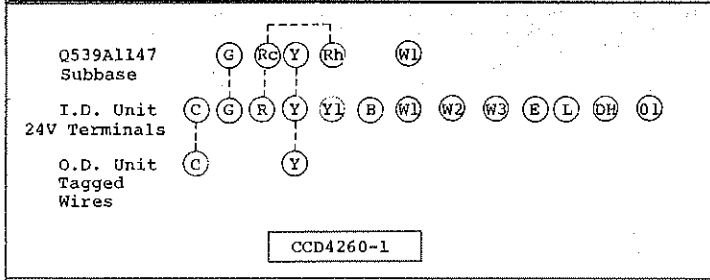

HEAT PUMP CONTROL CIRCUIT WIRING DIAGRAMS

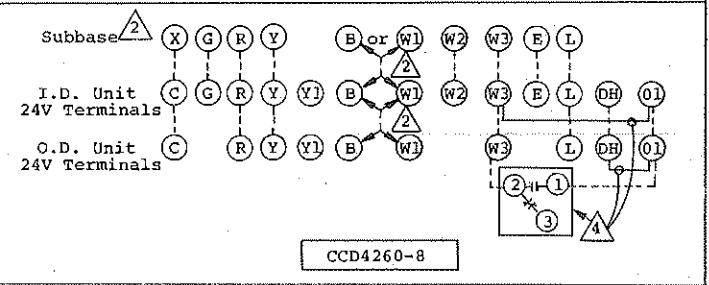
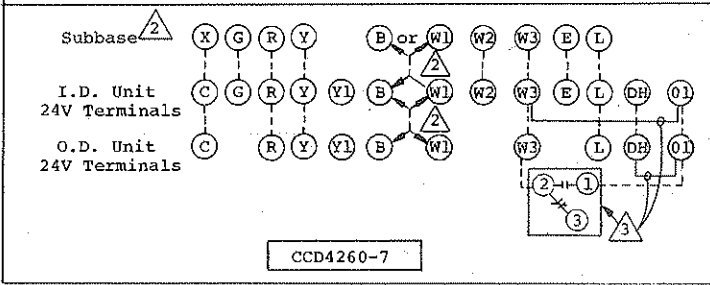
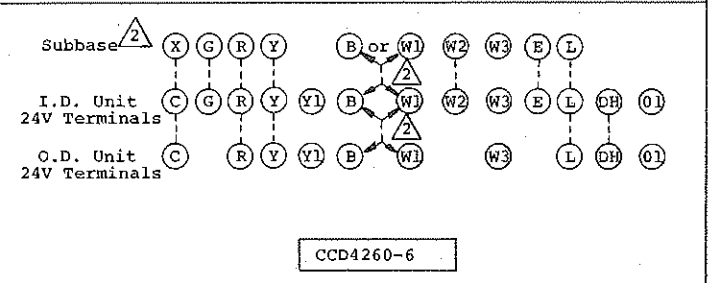
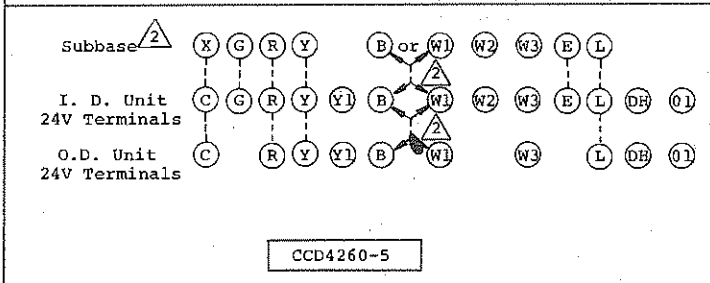

NOTES

- 1 Optional outdoor thermostat, used to hold last 5, 10 or 15Kw for 25, 30 and 35Kw models respectively, from cycling with the normal 10Kw on 2nd stage of wall stat. Use 8408-001 or 8408-005.
- 2 "E" terminals only are used with combination A 8403-012 (T872R1164) stat and 8404-007 (Q672L1185 sub-base). "W1" terminals only are used with combination B 8403-015 (T872N1036) stat and 8404-008 (Q672F1299) sub-base.
- 3 Optional outdoor thermostat, used to keep last 5, 10 or 9Kw for 15, 20 and 18Kw models respectively, from cycling with the 1st 10 or 9Kw on 2nd stage of wall stat. Cycles on based on outdoor temperature. Automatically cycles on during defrost, Em. Ht. and compressor cut-off. Remove factory jumpers W3 - 01 at indoor unit and DH-01 at outdoor unit.
- 4 Optional outdoor thermostat used to hold 2nd 10Kw heater bank from cycling on stage 2 of wall stat, cycles on based on outdoor temperature. The last 5, 10 or 15Kw cycles on only during Em. Ht., compressor cut-off, or defrost cycle. Remove factory jumpers W3-01 at indoor unit and DH-01 at outdoor unit.

COMPRESSOR CUT-OFF — ALL H.P. MODELS

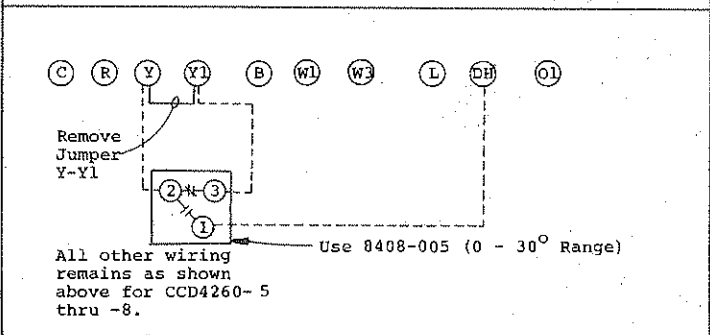

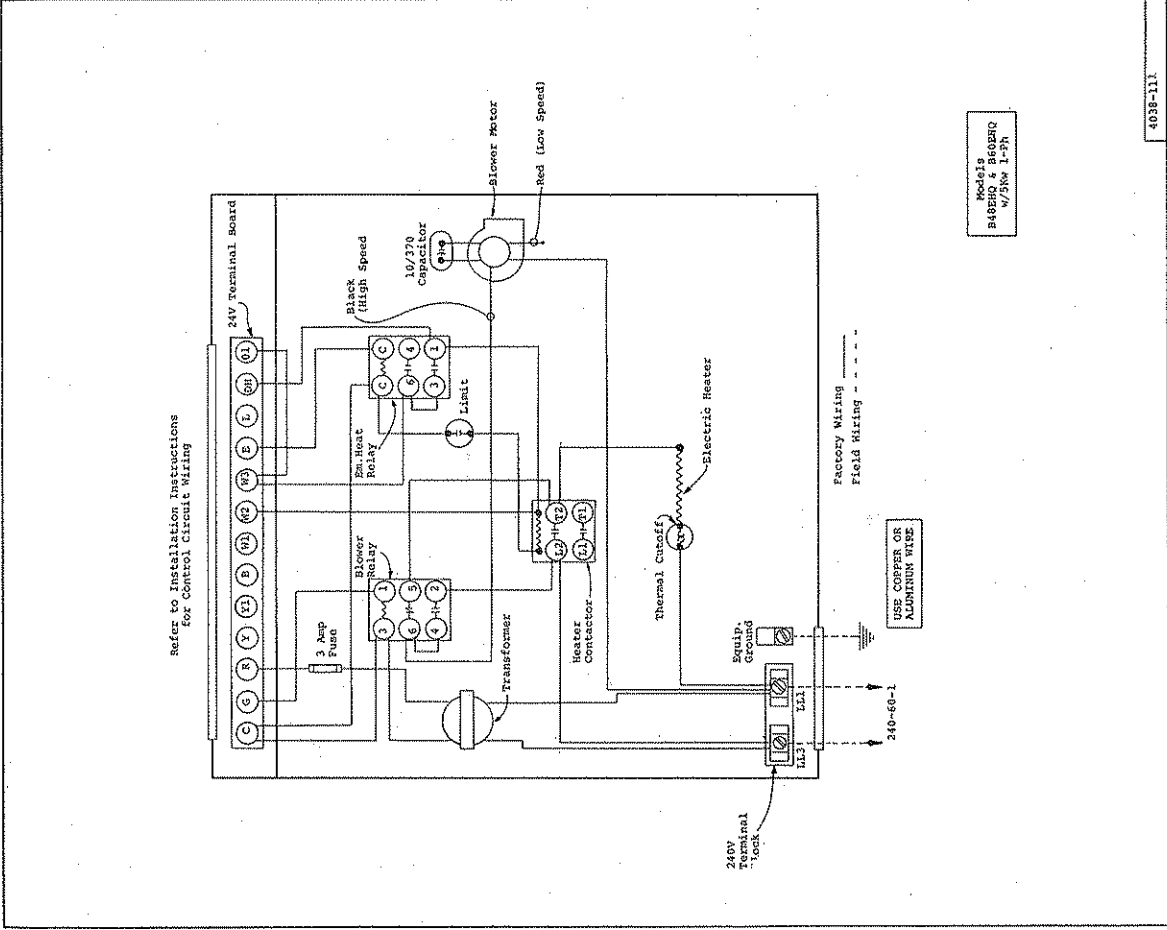
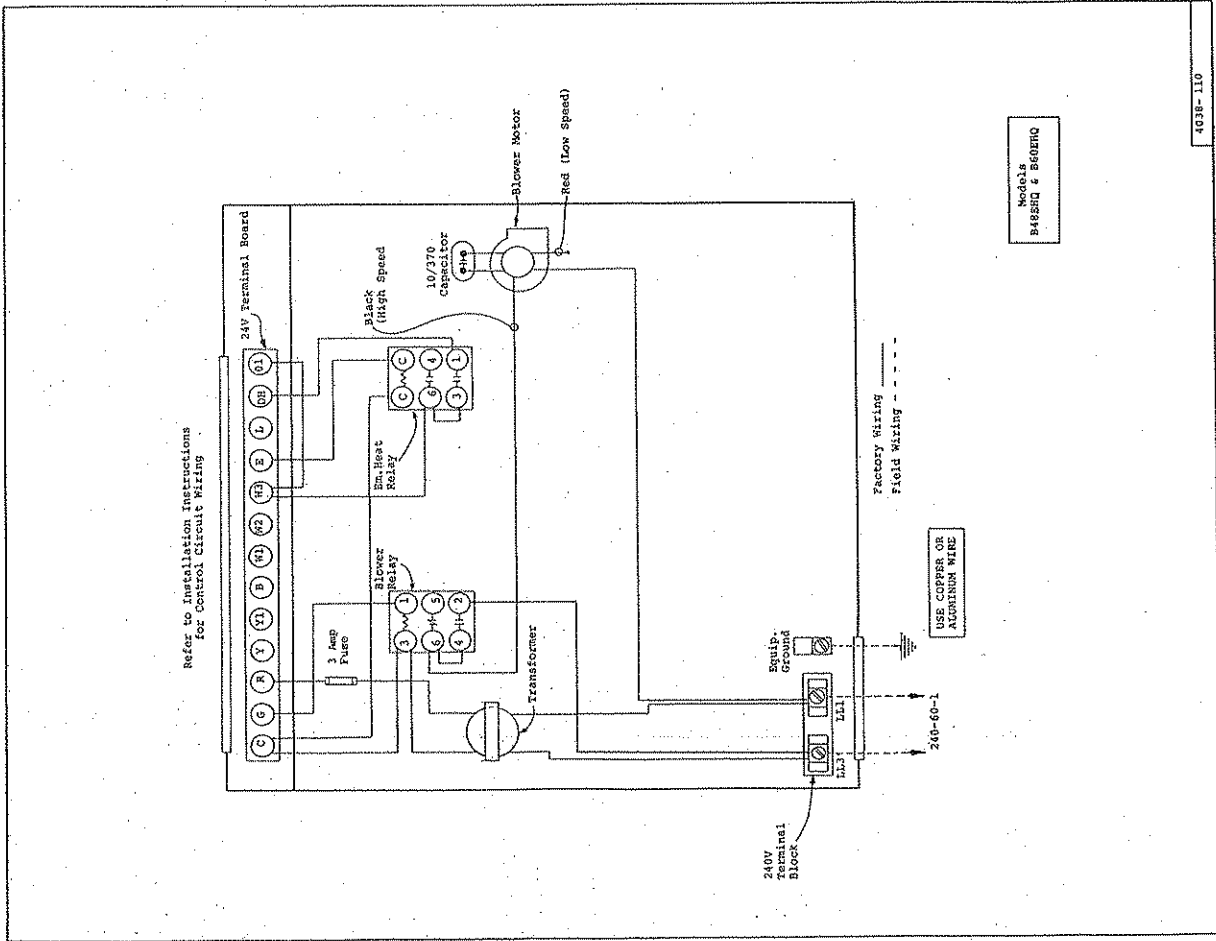

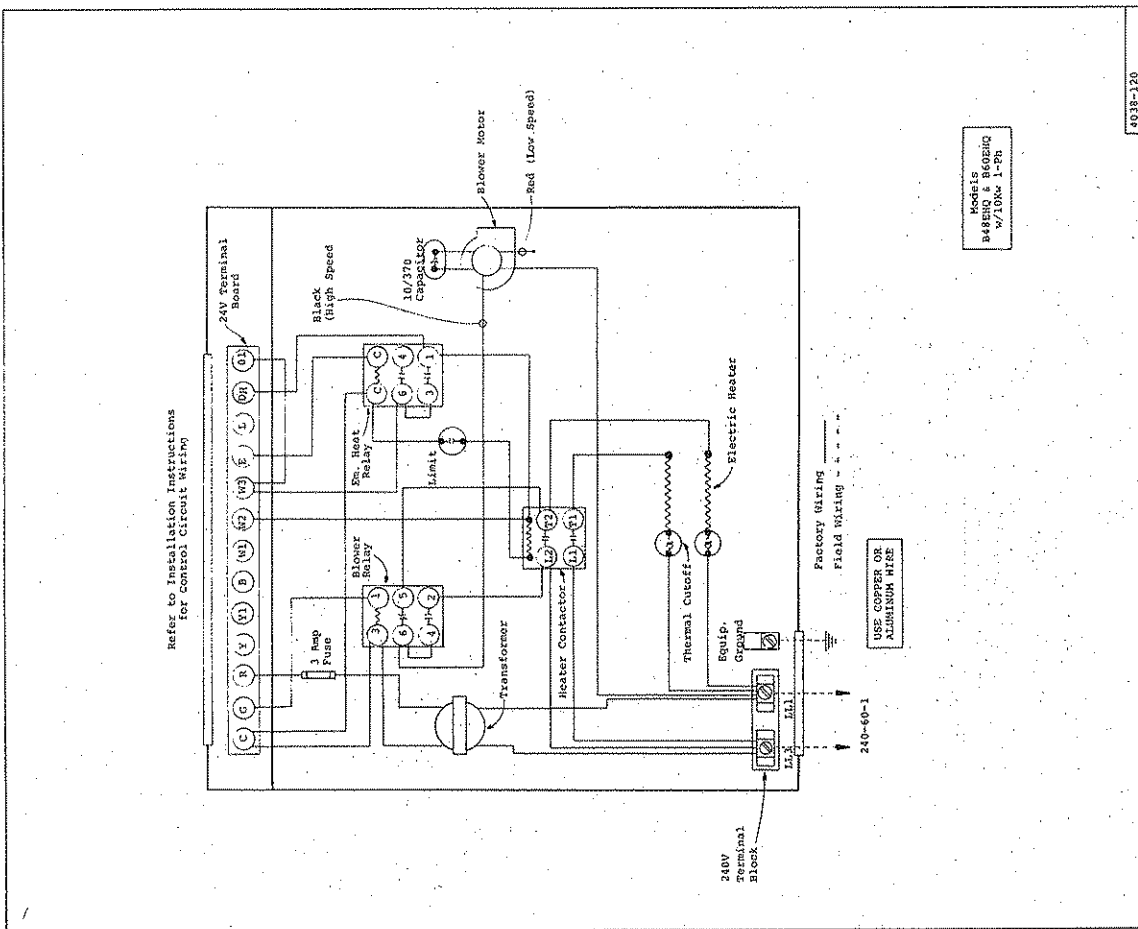
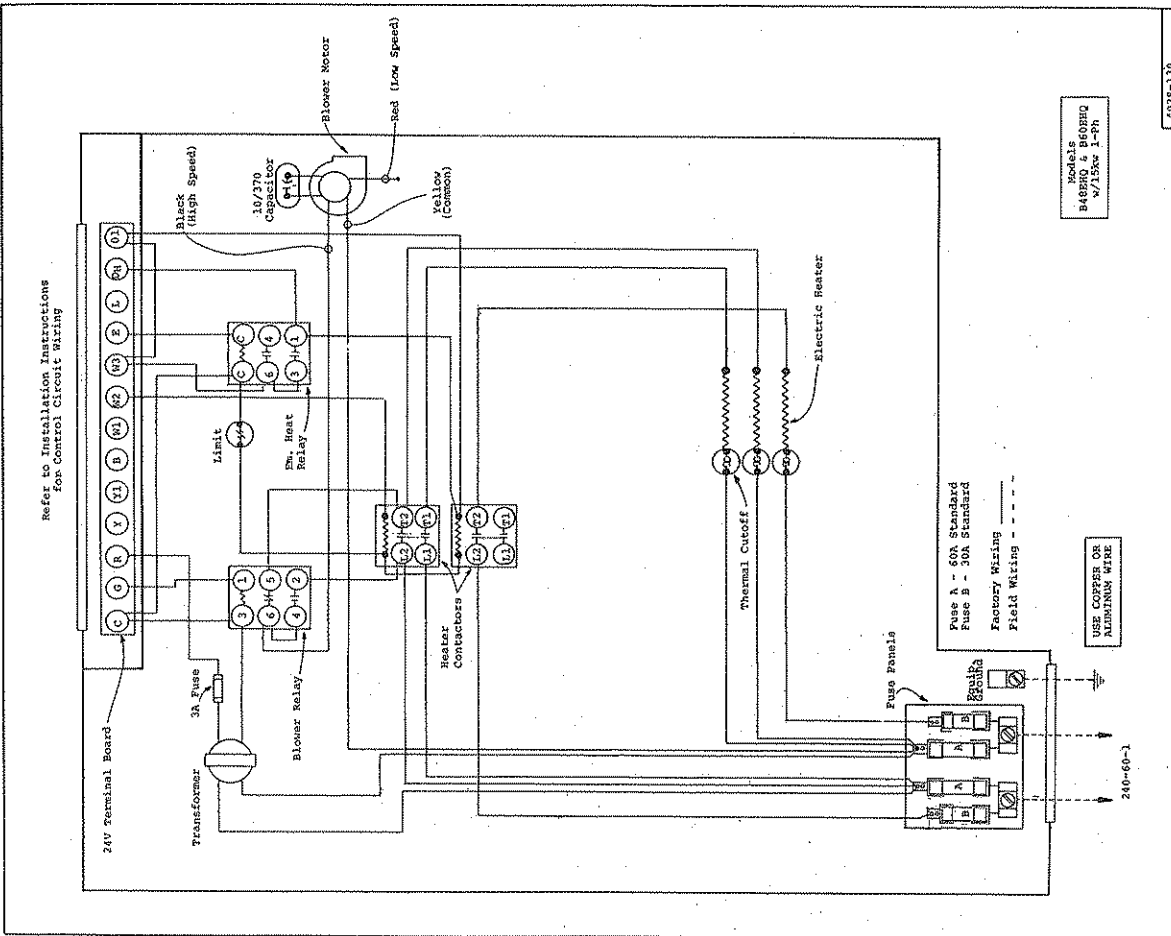

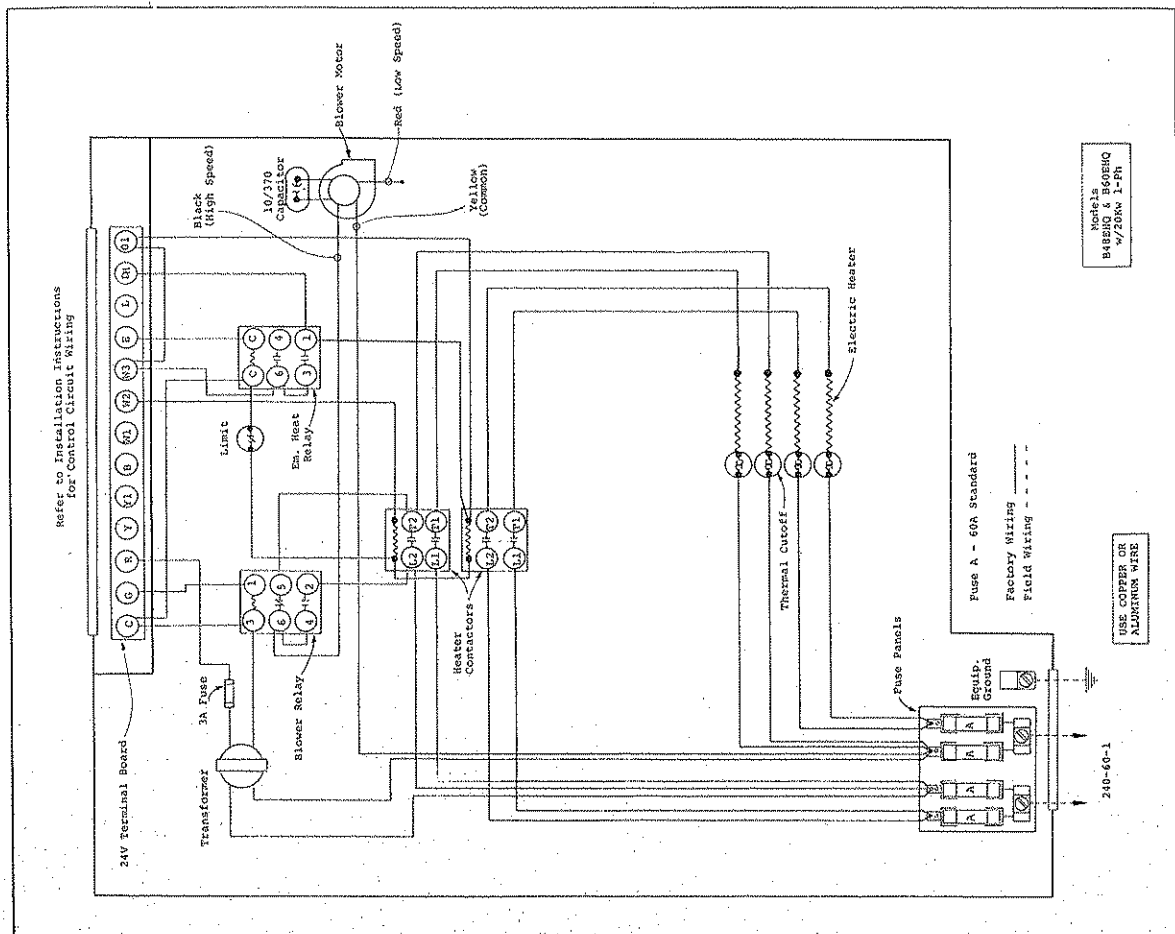
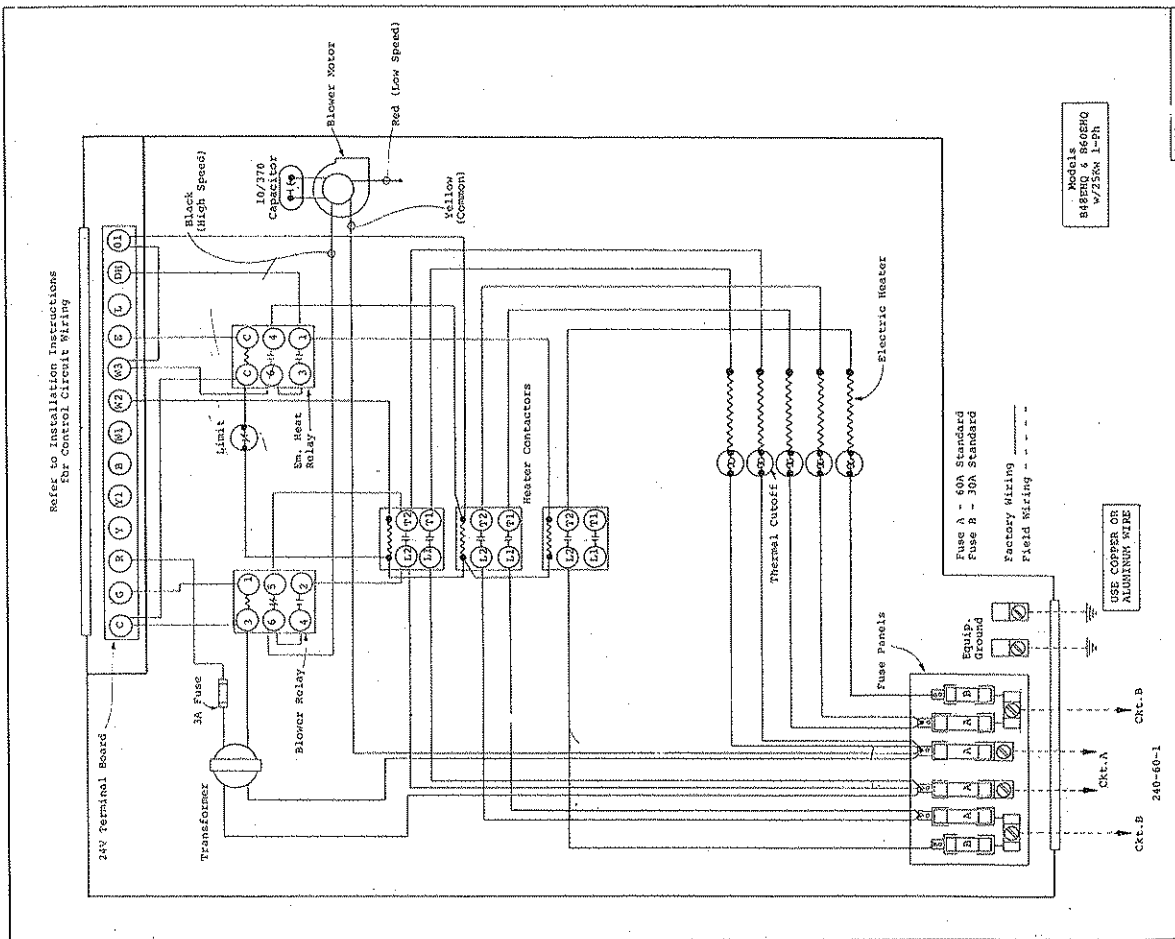

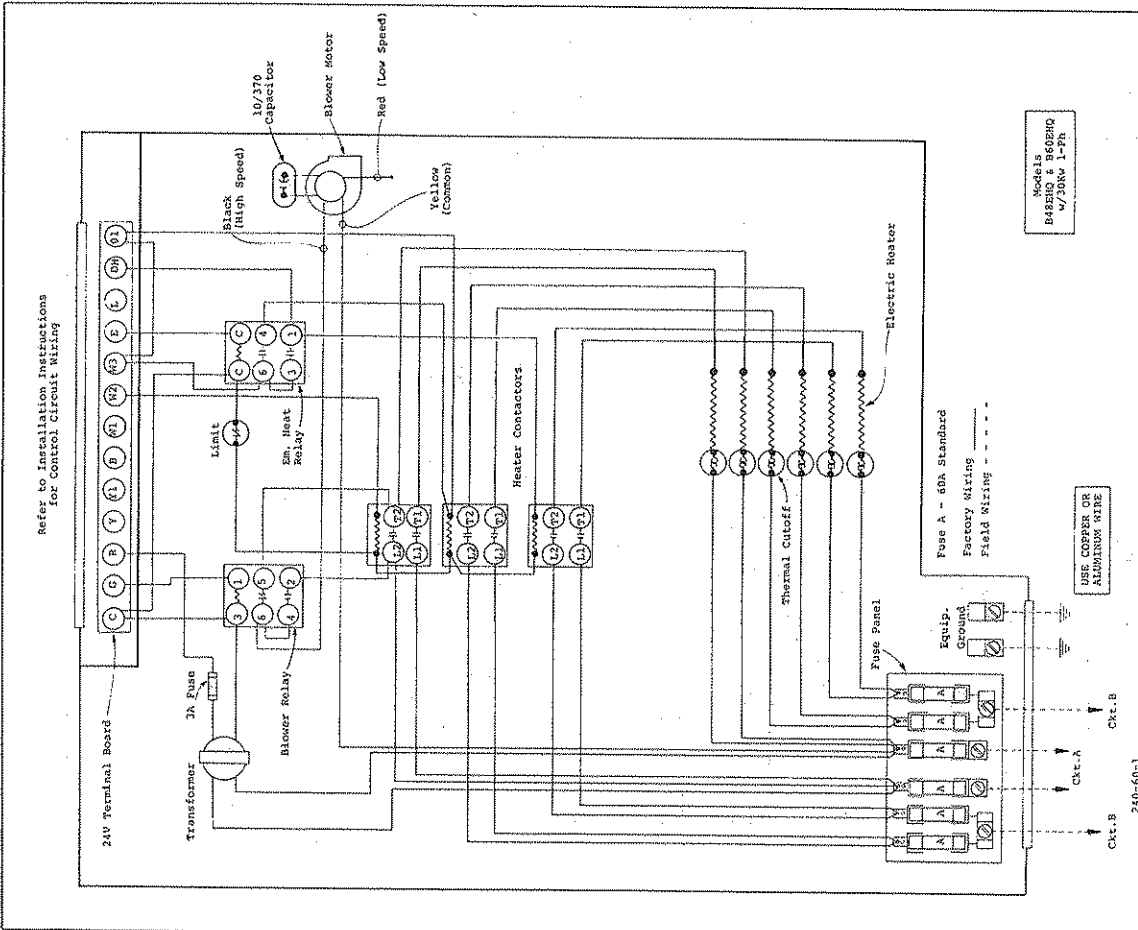
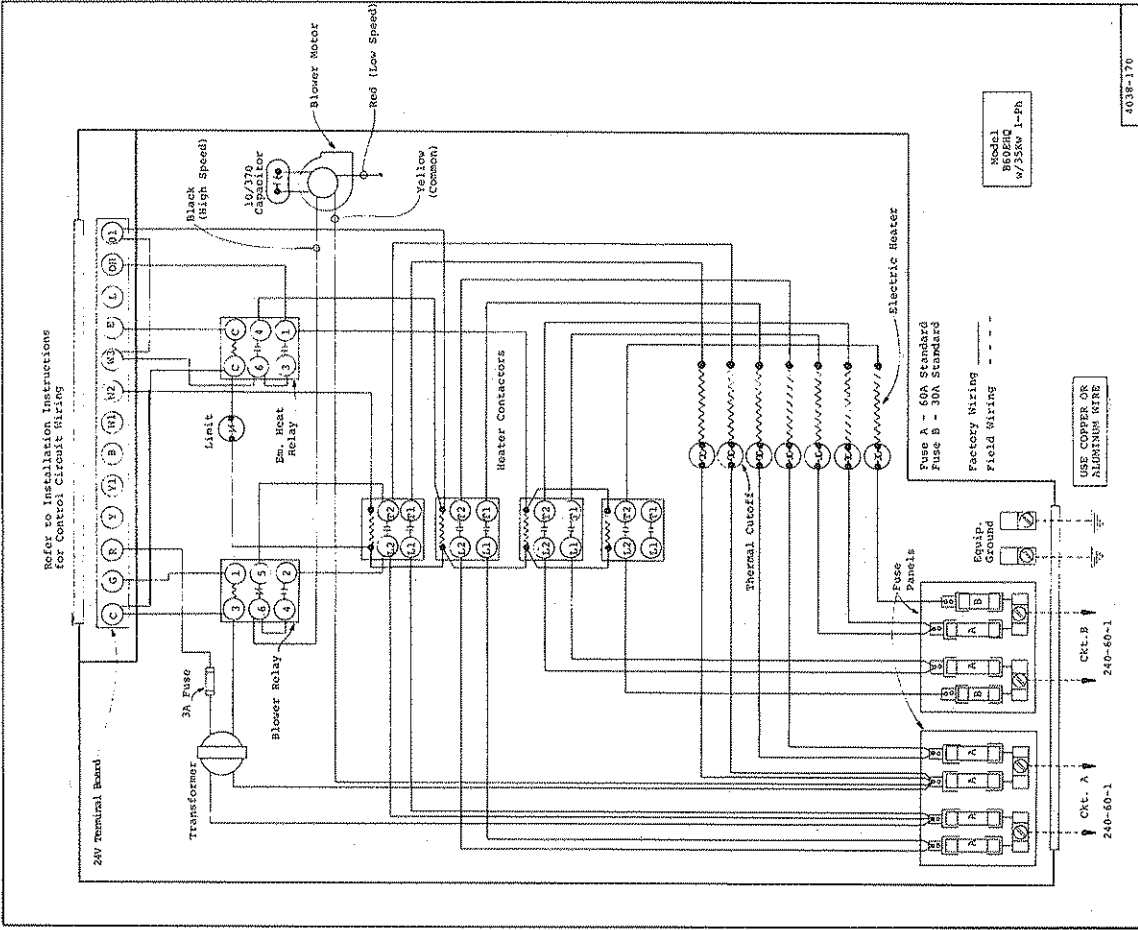

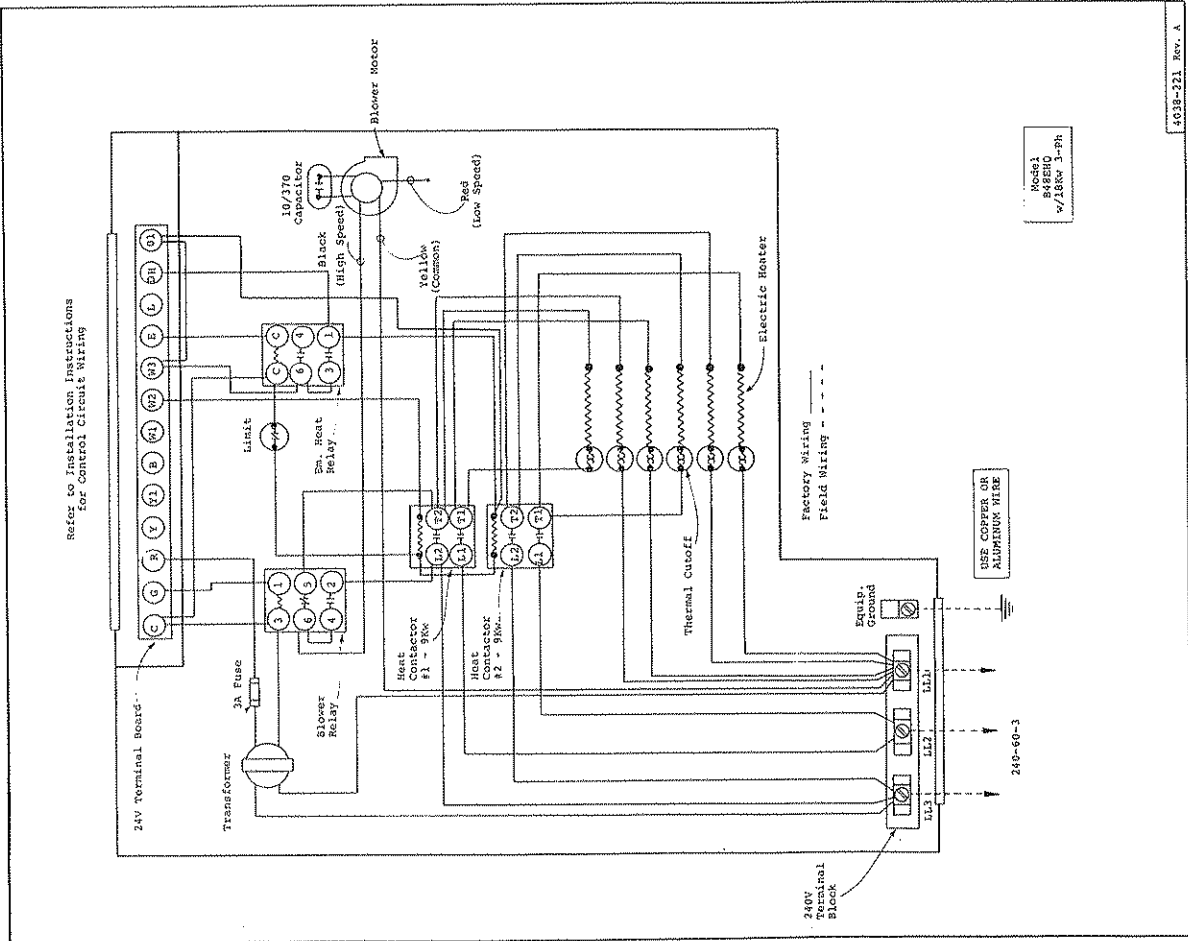
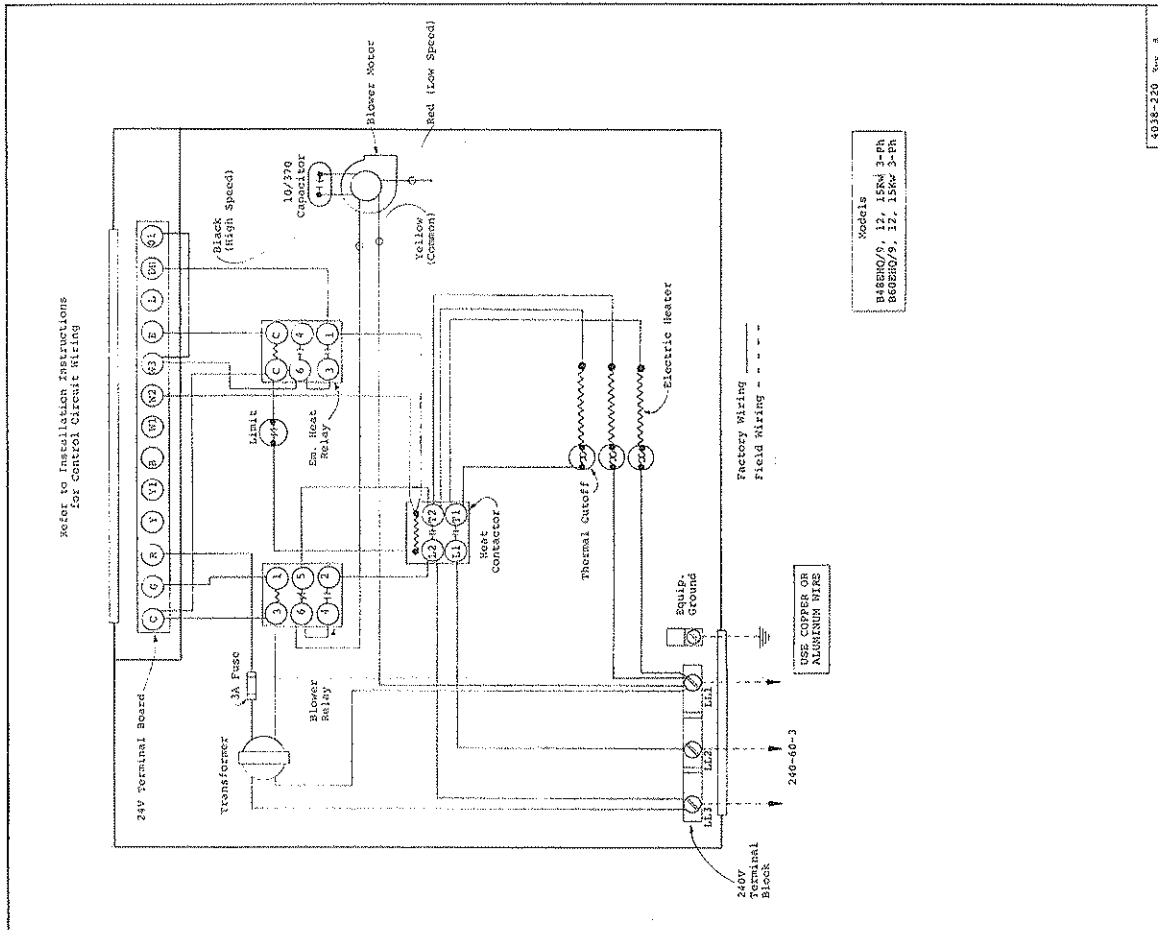

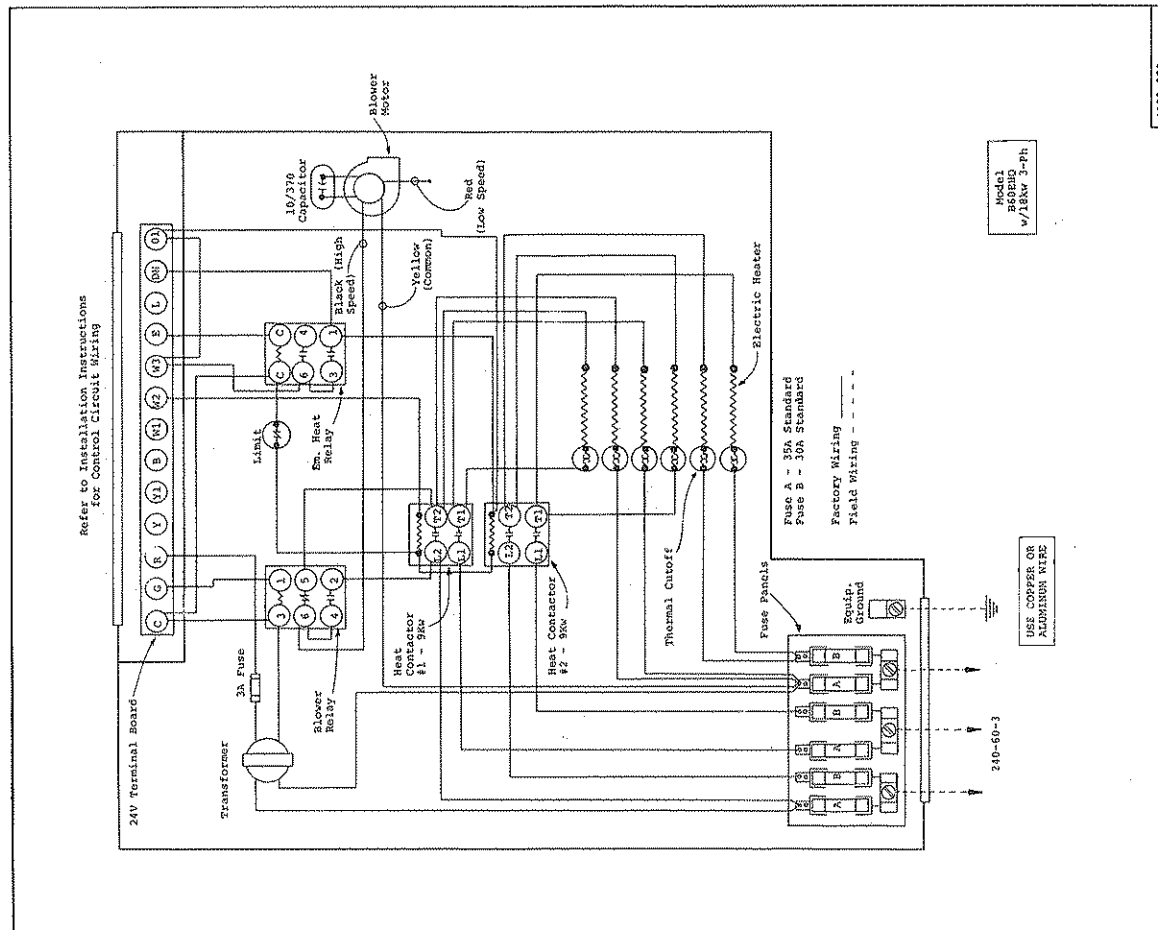
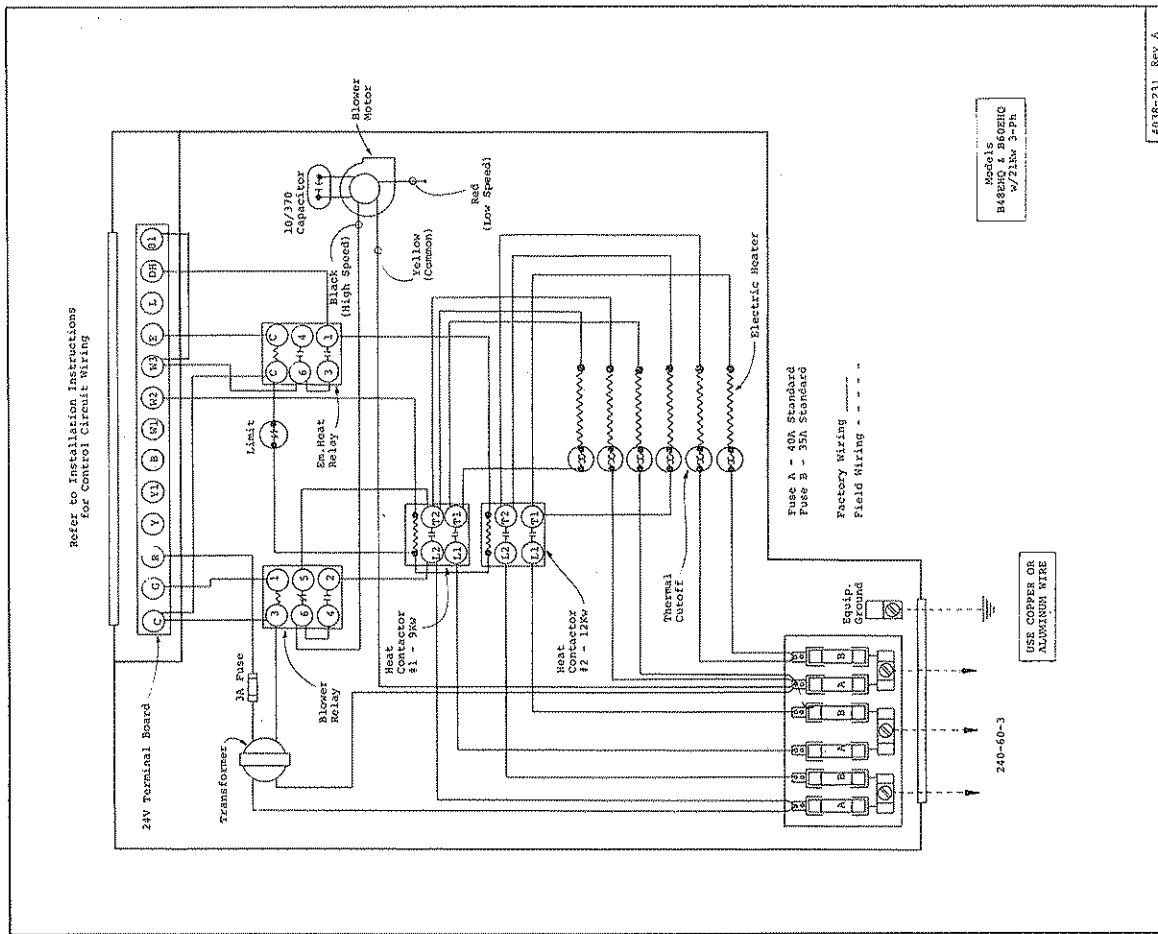

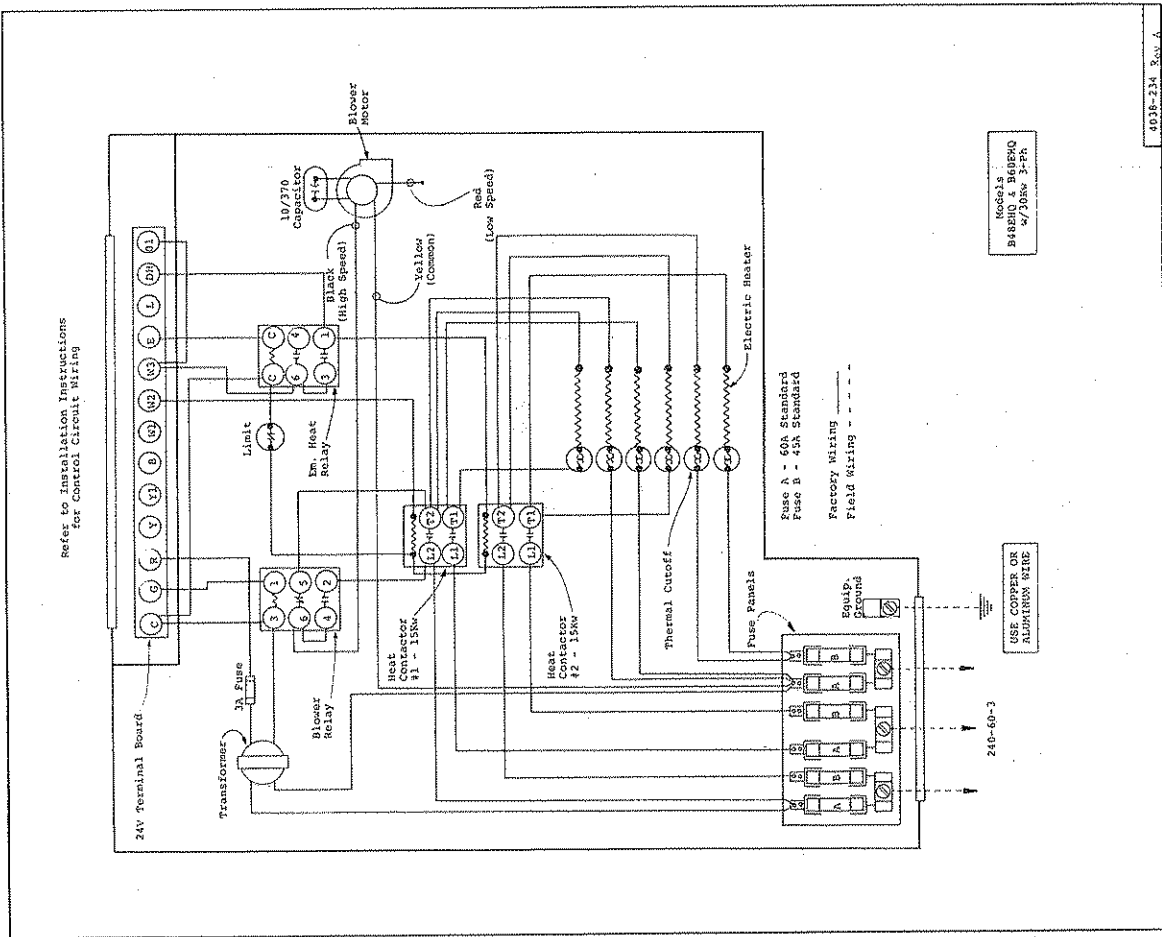

4018-114 Rev. A

PARTS LIST
SPLIT SYSTEM BLOWER COILS

PART NO.	DESCRIPTION	B48EHQ	B60EHQ
5152-027	Blower Housing 10-10	x	
5152-015	Blower Wheel 10-10	x	
5152-044	Blower Wheel 12-7		x
8552-002	Capacitor 5/370V	x	
8552-005	Capacitor 10/370V		x
5811-009	Capillary Tube	(4)	(4)
5651-006	Check Valve	x	x
8401-006	Contactora - Heater 20A	x	x
8401-010	Contactora - Heat 3-Ph	x	x
8401-001	Contactora - Heat 3-Ph	x	x
5060-020	Evaporator Coil	x	x
7004-015	Filter 24x24	x	x
8614-006	Fuse - Heater 30A	x	x
8614-007	Fuse - Heater 60A	x	x
8614-035	Fuse - Heater 35A 3-Ph	x	x
8614-033	Fuse - Heater 45A 3-Ph	x	x
8614-032	Fuse - Heater 40A 3-Ph	x	x
8614-017	Fuse Block 15Kw	x	x
8614-014	Fuse Block 25Kw	x	x
8614-019	Fuse Block 30Kw	x	x
8614-018	Fuse Block 20Kw	x	x
8614-020	Fuse Block 30Kw 3-Ph	x	x
8614-021	Fuse Block 3-Ph		x
8604-023	Heat Strip 5Kw		x
8604-024	Heat Strip 10Kw	x	x
8604-025	Heat Strip 15Kw	x	x
8604-035	Heat Strip 9Kw	x	x
8604-036	Heat Strip 12Kw	x	x
8402-033	Limit Switch L140-2.5	x	
8402-012	Limit Switch L130-1.5		x
8106-013	Motor - Blower 1/2 hp	x	
8107-003	Motor - Blower 3/4 hp		x
8200-003	Motor Mount	x	
8200-021	Motor Mount		x
5451-011	Motor Mounting Parts	x	x
8201-014	Relay - Blower	x	x
8201-013	Relay - Emergency Heat	x	x
5210-006	Strainer	x	x
8607-001	Terminal Block 230V	x	x
8607-002	Terminal Block 3-Ph	x	x
8607-010	Terminal Block	x	x
8402-025	Thermal Cut-off	x	x
8407-022	Transformer	x	x
5152-043*	Blower Housing 12-7		x

* To order Blower Housing for B60EHQ, use this part number and specify "Blower Housing only" on your order.

IMPORTANT

PURCHASER'S RESPONSIBILITIES

Below are the responsibilities of the purchaser and these items cannot be considered as defects in workmanship or material.

1. Air filter cleaning or replacement.
2. Failure to operate due to improper air distribution over indoor and outdoor equipment sections.
3. Failure to start due to voltage conditions, blown fuses or other damage due to inadequacy or interruption of electrical service.
4. Damage caused directly or indirectly by improper installation.
5. Damage due to lack of proper and periodic maintenance.
6. Damage resulting from transportation, moving or storage of unit.
7. Unit must be readily accessible for servicing and/or repair at all times.
8. Any adjustment or service to the unit should be made by qualified service personnel.
9. Misapplication of product.

MODEL NO. _____ SERIAL NO. _____ DATE
INSTALLED _____

INSTALLER: Please fill in above blanks and leave this manual with equipment owner/operator.