

INSTALLATION INSTRUCTIONS

MODELS

MH30B, MH36B, MH42B

PACKAGED HEAT PUMPS

FOR RESIDENTIAL, COMMERCIAL,
OR MOBILE HOME
HEATING/COOLING APPLICATIONS

COPYRIGHT AUGUST, 1989
BARD MANUFACTURING COMPANY
BRYAN, OHIO

UNPACKING THE SELF-CONTAINED UNIT

It is recommended that the unit be unpacked at the installation site to minimize damage due to handling.

1. Cut and remove the metal band from around unit.
2. Remove the carton from the unit.
3. The installation manual is contained in an envelope shipped with the unit. Make sure that it does not get lost.
4. Carefully block up the unit and remove the shipping skid.
5. CAUTION - DO NOT tip the unit on its side. Oil may enter the compressor cylinders and cause starting or operating trouble. If unit has set on its side, restore to upright position and do not run for several hours. Also run intermittently for a few seconds. Do this three or four times with three minutes in between. Observe abnormal compressor noise.

INSTALLING THE SUPPLY AND RETURN FITTINGS ON THE SELF-CONTAINED UNIT

The supply and return fittings are to be fastened with sheet metal screws on three sides. Seal with duct tape on all four sides.

LOCATING AND INSTALLING THE RETURN AIR ASSEMBLY-- MOBILE HOME APPLICATION

IMPORTANT

The MH42B unit requires two twelve inch diameter return air ducts. Sufficient airflow for proper system operation is not available using a single return air duct.

To avoid complications, locate and install the return air assembly first. The return air box with grille and filter can be located anywhere in the floor of the mobile home. Keep in mind that the closer to the cooling unit the better because less duct will be needed. Always use at least one 7' length of duct, however, a good spot is under the television set in a corner or under a table or davenport if a minimum two inch clearance is available. If desired, the return opening can be located inside a closet with louvered doors. The return air grille can be placed in the wall of a closet and the air conducted into the filter box through a boxed-in area at the closet floor level. Make sure filter is readily accessible.

After determining the location of the return air opening, start the installation from under the home by cutting a small hole in the fiber underboard to determine how the floor joist location will affect the cutting of the opening needed for the box. Floor joists generally are located on 16" centers leaving 14-3/8" between joists. After measuring the return air box cut the hole so the box will fit between the floor joists. In most installations it will be necessary to cut a similar hole in the fiberboard directly under the one in the floor. However, if the floor is more than 10" deep, it will only be necessary to cut a round hole for the collar on the return air box or for the insulated duct.

Finally, set the box into the opening and fasten with screws or nails. Put the filter and the return air grille in place.

LOCATING AND INSTALLING THE SUPPLY DUCT CONNECTORS MOBILE HOME APPLICATION

When locating the supply duct connector, check carefully for floor joists, axles, wheels and frame members that could interfere with the installation of the connector or with the running of the flexible duct. Ideally, the supply duct connector should be located in the bottom of the main duct, forward of center of the mobile home BUT NOT UNDER A REGISTER.

To locate the center of the duct, first cut a 6" hole in the fiberboard below the duct at the desired location. After locating the duct center, increase the hole in the fiberboard to approximately the size of the connector to be used. Next cut an opening in the bottom of the duct 1/8" larger than the actual dimension of the connector being used. After inserting the connector, bend the tabs flat inside the duct.

It is a good practice to seal all connections with duct tape. Seal the opening in the fiberboard around the duct connector.

For double wide homes or for special applications, these connectors are fed by two flexible ducts.

CONNECTING THE INSULATED RETURN-AIR AND SUPPLY FLEXIBLE DUCTING

All flexible ducts are furnished with a male and female metal end. The ducts can be connected to the corresponding fitting and sheet metal screwed in place. Slide the insulation and outer jacket over the end and use duct tape to seal joints.

If the flexible ducts are long enough, it will be easier to connect them to the fittings on the unit before sliding the unit into place.

RECOMMENDED REGISTER TYPE

Satisfactory heating/cooling of a mobile home will depend greatly on what type register is used. A very open type with no deflection (allowing the air to move straight up) is best. If these are not available, straighten the fins of the present registers as much as possible.

DUCT REQUIREMENTS

THE SUPPLY DUCT SYSTEM, INCLUDING THE NUMBER AND TYPE OF REGISTERS, WILL HAVE MUCH MORE EFFECT ON THE PERFORMANCE OF AN AIR CONDITIONING SYSTEM THAN ANY OTHER FACTOR! The duct must be sufficiently large to conduct an adequate amount of air to each register. The registers must be designed to throw the cooled air up to the ceiling. The duct must be built tightly enough to prevent loss of cooled air to the outside.

IMPORTANT: The MH42B unit requires two 12 inch diameter return air ducts. Sufficient airflow for proper system operation is not available using a single return air duct.

The output delivery of the system will not cool the home if the air is lost to the outside through leaks in the duct system. Also, the duct can be large enough in dimension but too small because it is collapsed or restricted with a foreign object. See chart for airflow and static pressure capabilities.

For rooftop or permanent structure applications, either round pipe or rectangular ductwork can be used, following standard duct sizing and layout techniques.

INDOOR BLOWER PERFORMANCE CFM - Dry Coil*			
E.S.P. (in. H ₂ O ^{***})	MH30B	MH36B	MH42B
.00	1295	1335	1475
.10	1250	1290	1445
.20	1200	1230	1410
.30	1135	1175	1360
.40	1075	1120	1310
.50	1000	1050	1235
.60**	940	980	1160

*CFM with 10Kw heaters installed.
**Maximum E.S.P. on heating.
***With 20x20 permanent filter and return air filter box installed.

RATED CFM and E.S.P. (Wet Coil-Cooling)			
Model	Rated CFM	Rated E.S.P.	Recommended Airflow Range
MH30B	1000	.50	900 - 1100
MH36B	1050	.50	945 - 1155
MH42B	1200	.50	1080 - 1320

IMPORTANT

The equipment covered in this manual is to be installed by trained, experienced service and installation technicians. Any heat pump is more critical of proper operating, charge and an adequate duct system than a straight air conditioning unit. All ductwork, supply and return, must be properly sized for the design air flow requirement of the equipment. ACCA is an excellent guide to proper sizing. All ductwork or portions thereof not in the conditioned space should be properly insulated in order to both conserve energy and prevent condensation or moisture damage.

SHIPPING DAMAGE

Upon receipt of equipment, the carton should be checked for external signs of shipping damage. If damage is found, the receiving party must contact the last carrier immediately, preferably in writing, requesting inspection by the carrier's agent.

GENERAL

The refrigerant system is completely assembled and charged. All internal wiring is complete.

These instructions explain the recommended method to install the air cooled self-contained unit and the electrical wiring connections to the unit.

These instructions and any instructions packaged with any separate equipment required to make up the entire air conditioning system should be carefully read before beginning the installation. Note particularly "Starting Procedure" and any tags and/or labels attached to the equipment.

While these instructions are intended as a general recommended guide, they do not supersede any national and/or local codes in any way. Authorities having jurisdiction should be consulted before the installation is made.

INSTALLATION

Size of the unit for a proposed installation should be based on heat loss calculation made according to methods of National Warm Air Heating and Air Conditioning Association. The air duct should be installed in accordance with the Standards of the National Fire Protection Association for the Installation of Air Conditioning and Ventilating Systems of Other Than Residence Type, NFPA No. 90A, and Residence Type Warm Air Heating and Air Conditioning Systems, NFPA No. 90B. Where local regulations are at a variance with instructions, installer should adhere to local codes.

WIRING - MAIN POWER

Refer to the unit rating plate for wire sizing information and maximum fuse or "HACR Type" circuit breaker size. Each unit is marked with a "Minimum Circuit Ampacity." This means that the field wiring used must be sized to carry that amount of current. Refer to the National Electrical Code for complete current carrying capacity data on the various insulation grades of wiring material.

If an optional heater package is installed, a separate power circuit must be added. Refer to the Electrical Information Chart for circuit information. **DO NOT ATTEMPT TO COMBINE A BASIC UNIT AND A HEATER PACKAGE TO ONE POWER SUPPLY CIRCUIT.**

The unit rating plate lists a "Maximum Time Delay Fuse" or "HACR Type" circuit breaker that is to be used with the equipment. The correct size must be used for proper circuit protection and also to assure that there will be no nuisance tripping due to the momentary high starting current of the compressor motor.

If this unit is operated in cooling below a 65° outdoor ambient temperature, the installation of low ambient controls (LAC-1 and 8201-008 relay) to unit is required.

ELECTRICAL INFORMATION										WIRING INFORMATION ②						
Model	Volts/PH	Optional Heater Package	Max. Unit Amps	No. Field Power Circuits	Optional Heater Internal Fuses	Required Overcurrent Protection ①		Minimum Circuit Ampacity		Power Circuit Wiring		Ground Wire Size ③				
						Ckt. A	Ckt. B	Ckt. A	Ckt. B	Ckt. A	Ckt. B	Ckt. A	Ckt. B			
MH30B ④	230/208 60-1	None	21.3	1		40	30	26	26	10	10	10	10			
		EH3MA-A05	42.1	2										52	6	10
		EH3MA-A10	62.9	2										78	3	8
		EH3MA-A15	65.1	2	30/60									104	1	6
		EH3MA-A20	85.7	2	60											
MH36B ④	230/208 60-1	None	24.3	1		45	30	30	26	10	10	10	10			
		EH3MA-A05	45.1	2										52	6	10
		EH3MA-A10	65.9	2										78	3	8
		EH3MA-A15	65.9	2	30/60									104	1	6
		EH3MA-A20	85.7	2	60											
MH42B ④	230/208 60-1	None	31.3	1		60	30	39	26	8	10	10	10			
		EH3MA-A05	52.1	2										52	6	10
		EH3MA-A10	72.9	2										78	3	8
		EH3MA-A15	72.9	2	30/60									104	1	6
		EH3MA-A20	85.7	2	60											

- ① Time delay fuses or "HACR Type" circuit breakers must be used for 60 and smaller sizes. Standard fuses or circuit breakers are suitable for sizes 70 and larger.
- ② Based on 60°C copper wire. Other wiring materials must be rated for marked "Minimum Circuit Ampacity" or greater.
- ③ Based upon Table 250-95 of N.E.C., 1981.
- ④ Maximum of 10Kw operates with heat pump, extra 5 or 10Kw of 15 or 20Kw models operates during emergency heat operation.

OPTIONAL ELECTRIC HEATER PACKAGES

Four electric heater packages are available as options. Each package comes complete with heaters and controls. Model numbers of approved electric heat packages are as follows:

EH3MA-A05	(5Kw)
EH3MA-A10	(10Kw)
EH3MA-A15	(15Kw)
EH3MA-A20	(20Kw)

IMPORTANT: A separate power entrance is required for the heater package. DO NOT attempt to wire a basic unit and a heater package to one power circuit.

INSTALLATION

Installation of the heat package requires removing the unit blower from its securing slide mount, inserting the heat package into the same mount and reinstalling the unit blower into a similar mount on the heat package. A minimal amount of wiring is required. Refer to the heat package installation instructions for detailed installation information.

WIRING -- LOW VOLTAGE, THERMOSTAT

To select the appropriate number of thermostat wires to be run and the correct thermostat, refer to the chart below.

Optional Heater Package	Number of Thermostat Wires Req'd.	Thermostat/Subbase
None	6	T874N1024/Q674F1261
EH3MA-A05	10	or T874R1129/Q674L1181
EH3MA-A10	10	
EH3MA-A15	10	
EH3MA-A20	10	

PRESSURE SERVICE PORTS

High and low pressure service ports are installed on all units so that the system operating pressures can be observed. Pressure curves can be found later in the manual covering all models on both cooling and heating cycles. It is imperative to match the correct pressure curve to the unit by model number.

SEQUENCE OF OPERATION

Cooling - Circuit R-Y makes at thermostat pulling in compressor contactor starting the compressor and outdoor motor. The G (indoor motor) circuit is automatically completed on any call for cooling operation, or can be energized by manual fan switch on subbase for constant air circulation.

Heating - A 24V solenoid coil on reversing valve controls heating cycle operation. Two thermostat options, one allowing "Auto" changeover from cycle to cycle and the other constantly energizing solenoid coil during heating season and thus eliminating pressure equalization noise except during defrost, are to be used. On "Auto" option, a circuit is completed from R-W1 and R-Y on each heating "on" cycle, energizing reversing valve solenoid and pulling in compressor contactor starting compressor and outdoor motor. R-G also make starting indoor blower motor. Heat pump heating cycle now in operation. The second option has no "Auto" changeover position, but instead energizes the reversing valve solenoid constantly whenever the system switch on subbase is placed in "Heat" position, the "B" terminal being constantly energized from R. A thermostat demand for heat completes R-Y circuit, pulling in compressor contactor starting compressor and outdoor motor. R-G also make starting indoor blower motor.

SERVICE HINTS

1. Caution homeowner to maintain clean air filters at all times. Also, not to needlessly close off supply and return air registers. This reduces air flow through the system, which shortens equipment service life as well as increasing operating costs.
2. Switching to heating cycle at 75°F or higher outside temperature may cause a nuisance trip of the manual reset high pressure switch.

3. The heat pump wall thermostats perform multiple functions. Be sure that all function switches are correctly set for the desired operating mode before trying to diagnose any reported service problems.
4. Check all power fuses or circuit breakers to be sure that they are the correct rating.
5. Periodic cleaning of the outdoor coil to permit full and unrestricted airflow circulation is essential.

IMPORTANT INSTALLER NOTE
For improved start-up performance, wash the indoor coil with a dishwasher detergent.

REFRIGERANT CHARGE

The correct system R-22 charge is shown on the unit rating plate. Optimum unit performance will occur with a refrigerant charge resulting in a suction line temperature (6" from compressor) as shown in the following table:

Model	Rated Airflow	95°F O.D. Temperature	82°F O.D. Temperature
MH30B	1000	58 - 60	69 - 71
MH36B	1050	60 - 62	68 - 70
MH42B	1200	62 - 64	70 - 72

The above suction line temperatures are based upon 80°F dry bulb/67°F wet bulb (50% R.H.) temperature and rated airflow across the evaporator during cooling cycle.

CRANKCASE HEATERS

All units are provided with some form of compressor crankcase heat. Some single phase units utilize the compressor motor start winding in series with a portion of the run capacitor to generate heat within the compressor shell to prevent liquid refrigerant migration.

Some single phase models have an insertion well-type heater located in the lower section of the compressor housing. This is a self-regulating type heater that draws only enough power to maintain the compressor at a safe temperature.

Some form of crankcase heat is essential to prevent liquid refrigerant from migrating to the compressor, causing oil pump out on compressor start-up and possible valve failure due to compressing a liquid.

Refer to wiring diagram to find exact type of crankcase heater used.

The following decal is affixed to all outdoor units detailing start-up procedure. This is very important. Please read carefully.

IMPORTANT

THESE PROCEDURES MUST BE FOLLOWED AT INITIAL START-UP AND AT ANY TIME POWER HAS BEEN REMOVED FOR 12 HOURS OR LONGER.

TO PREVENT COMPRESSOR DAMAGE WHICH MAY RESULT FROM THE PRESENCE OF LIQUID REFRIGERANT IN THE COMPRESSOR CRANKCASE

1. MAKE CERTAIN THE ROOM THERMO STAT IS IN THE OFF POSITION (THE COMPRESSOR IS NOT TO OPERATE).
2. APPLY POWER BY CLOSING THE SYSTEM DISCONNECT SWITCH THIS ENERGIZES THE COMPRESSOR HEATER WHICH EVAPORATES THE LIQUID REFRIGERANT IN THE CRANKCASE.
3. ALLOW 4 HOURS OR 60 MINUTES PER POUND OF REFRIGERANT IN THE SYSTEM AS NOTED ON THE UNIT RATING PLATE, WHICHEVER IS GREATER.
4. AFTER PROPERLY ELAPSED TIME THE THERMOSTAT MAY BE SET TO OPERATE THE COMPRESSOR.
5. EXCEPT AS REQUIRED FOR SAFETY WHILE SERVICING -- DO NOT OPEN SYSTEM DISCONNECT SWITCH.

7981-081

COMPRESSOR CUT-OFF THERMOSTAT AND OUTDOOR THERMOSTATS

Heat pump compressor operation at outdoor temperatures below 0°F are neither desirable nor advantageous in terms of efficiency. Since most equipment at time of manufacture is not designated for any specific destination of the country, and most of the equipment is installed in areas not approaching the lower outdoor temperature range, the compressor cut-offs are not factory installed.

NOTE: Maximum amount of electric heat which can be operated in conjunction with the compressor during heating mode is 10Kw on 1 phase and 12Kw on 3 phase. The balance of the electric heat can be operated only during compressor cut-off or emergency heat mode.

COMPRESSOR CUT-OFF AND OUTDOOR THERMOSTAT WIRING

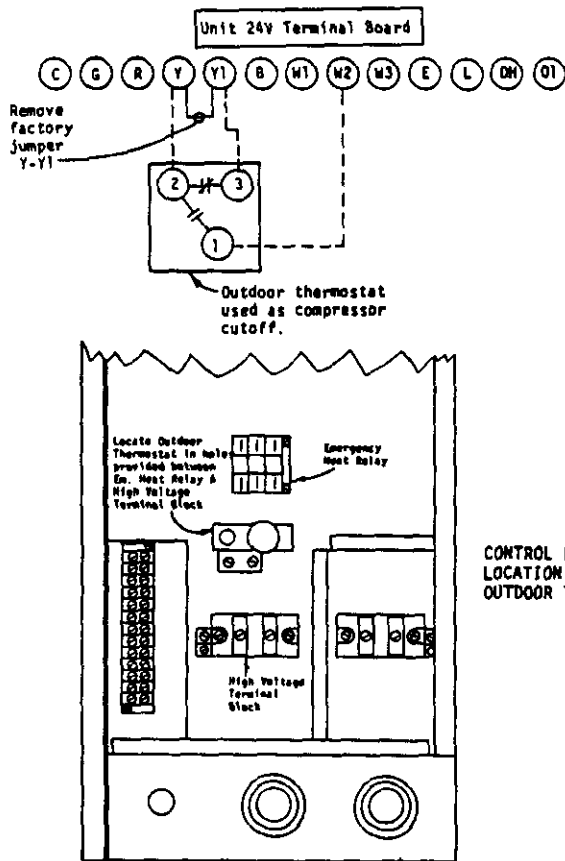

IMPORTANT NOTE: Both thermostat and subbase combinations shown incorporate the following features: Man-Auto fan switch, Off-Heat-Cool-Em.Heat Switch, and two (2) indicator lamps--one for emergency heat and one for compressor malfunction.

THERMOSTAT INDICATOR LAMPS

The red lamp marked "Em.Ht." comes on and stays on whenever the system switch is placed in the Em. Ht. position. The green lamp marked "check" will come on if there is any problem that prevents the compressor from running when it is supposed to be.

EMERGENCY HEAT POSITION

The operator of the equipment must manually place the system switch in this position. This is done when there is a known problem with the outdoor section, or when the green "check" lamp comes on indicating a problem.

DEFROST CYCLE

The defrost cycle is controlled by time and temperature. The 24 volt timer motor runs all the time the compressor is in operation. When the outdoor temperature is in the lower 40°F temperature range or colder, the outdoor coil temperature is 32°F or below. This temperature is sensed by the defrost thermostat mounted near the bottom of the outdoor coil on a return bend. The defrost thermostat closes at approximately 32°F. Every 60 (or 30) minutes that the compressor is running, contacts 3-5 close for 7 minutes, with contacts 3-4 closed for the first 40 seconds of that 7 minutes. If the defrost thermostat is closed, the defrost relay energizes and places the system in defrost mode. An interlocking circuit is created with timer contact 3-5 and defrost relay contact 7-9 in series.

During the defrost mode, the refrigerant cycle switches back to the cooling cycle, the outdoor motor stops, electric heaters are energized, and hot gas passing through the outdoor coil melts any accumulated frost. When the temperature rises to approximately 57°F, the defrost thermostat opens, de-energizing the defrost relay and returning the system to heating operation.

If some abnormal or temporary condition such as a high wind causes the heat pump to have a prolonged defrost cycle, contacts 3-5 of the defrost timer will open after 7 minutes and restore the system to heating operations automatically.

There are two time settings on the defrost timer--30 minutes and 60 minutes. Most models are shipped wired on the 60 minute setting for greatest operating economy. If special circumstances require a change to the shorter time, remove wire connected to terminal 5/60 and reconnect to terminal 5/30.

There is a manual advance knob located on the timer. This can be used to advance timer to contact closure point if it is desired to check out defrost cycle operation, without waiting for time to elapse.

HEAT ANTICIPATION

Both of the thermostats shown below have a fixed heat anticipator for stage 1 with no adjustment required. Stage 2 has an adjustable anticipator for the W2 connection and fixed for the W3 connection. Both the W2 and W3 circuits are controlled by the stage 2 bulb. The only heat anticipator that needs to be checked is stage 2 and it should be set to match the load carried by the W2 circuit. The normal factory wiring provides for only one electric heat contactor to be controlled by W2, and the anticipator should be set at .40A. If special field wiring is done, it is best to actually measure the load but a good rule is .40A for each heat contactor controlled by W2.

WALL THERMOSTAT AND SUBBASE COMBINATIONS			
Group	Thermostat	Subbase	Predominant Feature
A	8403-017 (T874R1129)	8404-009 (Q674L1181)	Heat or Cool ① No Auto
B	8403-018 (T874N1024)	8404-010 (Q674F1261)	Automatic Heat-Cool Changeover Position ②

- ① No automatic changeover position--must manually place in heat or cool. Reversing valve remains energized at all times system switch is in heat position (except during defrost cycle). No pressure equalization noise when thermostat is satisfied on either heating or cooling.
- ② Allows thermostat to control both heating and cooling operation when set in "AUTO" position. Reversing valve de-energizes at end of each "ON" heating cycle.

DEFROST TIMER WIRING

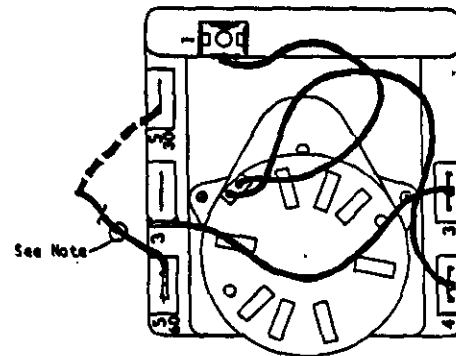

NOTE: All models are connected to 5/60 terminal (60 minute). Any model can be changed from 60 minutes to 30 minutes by unplugging from 5/60 terminal and reconnecting to 5/30 terminal as shown by dotted line.

**TYPICAL MH30B, MH36B
SINGLE SUPPLY DUCT SYSTEM**

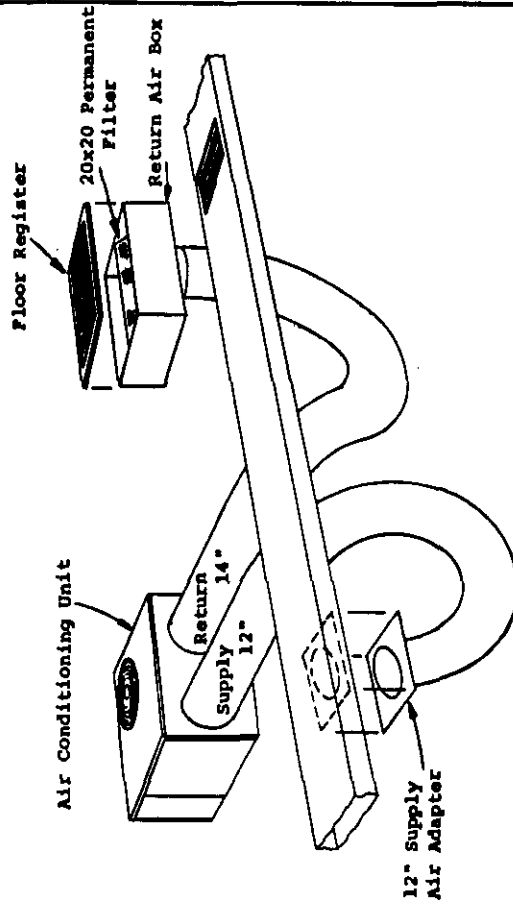

- Qty. 1** 7001-014 Fitting Pack
 (1) 12½ x 20 x 10½ Return Air Box
 (1) 20 x 20 Permanent Filter
 (1) 12 x 20 Floor Register
 (1) 12" Supply Air Adapter

NOTE: Flex Ducts are not supplied as part of the basic unit (field supplied).

**OPTIONAL MH30B, MH36B
DOUBLE SUPPLY DUCT SYSTEM**

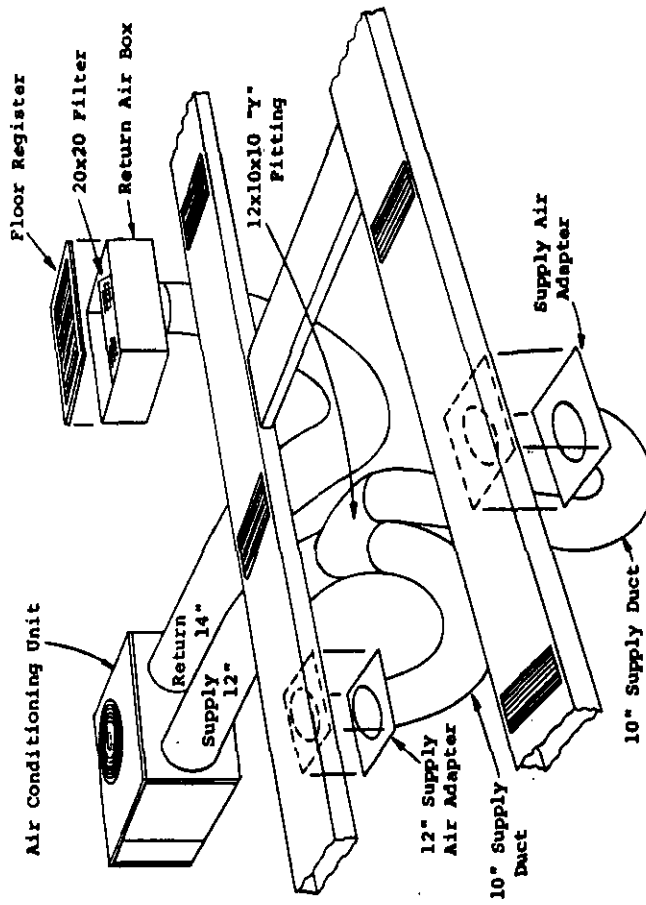

- Qty. 1** 7001-014 Fitting Pack
 (1) 12½ x 20 x 10½ Return Air Box
 (1) 20 x 20 Permanent Filter
 (1) 12 x 20 Floor Register
 (1) 12" Supply Air Adapter

- Qty. 1** 7001-015 Fitting Pack
 (1) 12 x 10 x 10 "Y" Fitting
 (2) 10" Supply Air Adapter

NOTE: Flex Ducts are not supplied as part of the basic unit (field supplied).

TYPICAL MH42B
SINGLE SUPPLY DUCT SYSTEM

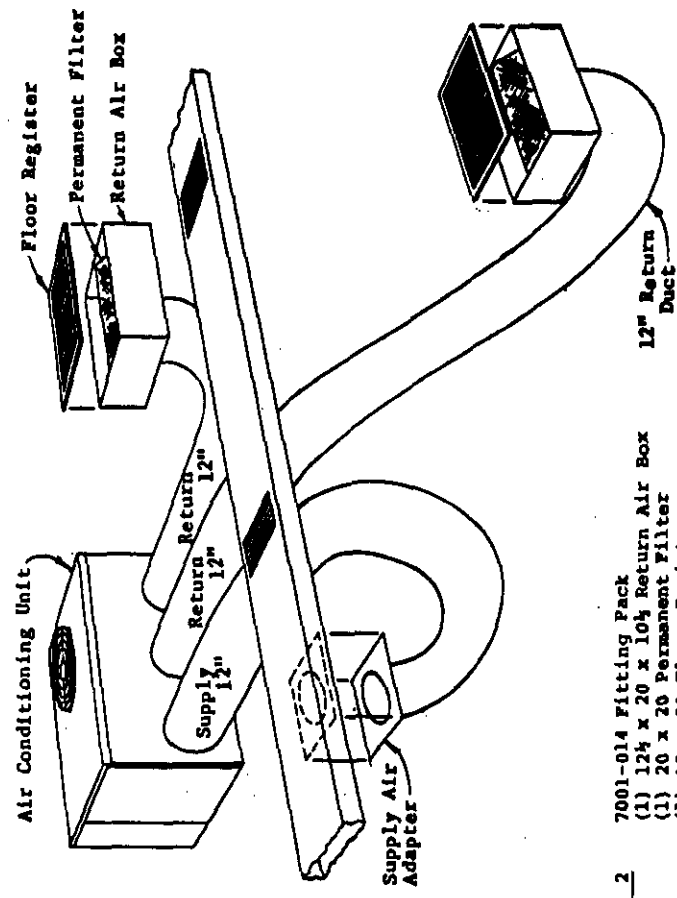

- Qty. 2 7001-014 Fitting Pack
 (1) 12 1/4 x 20 x 10 1/4 Return Air Box
 (1) 20 x 20 Permanent Filter
 (1) 12 x 20 Floor Register
 (1) 12" Supply Air Adapter

IMPORTANT: Two 12 inch diameter return air ducts must be installed. Ducts are not supplied as part of the basic unit (field supplied).

OPTIONAL MH42B
DOUBLE SUPPLY DUCT SYSTEM

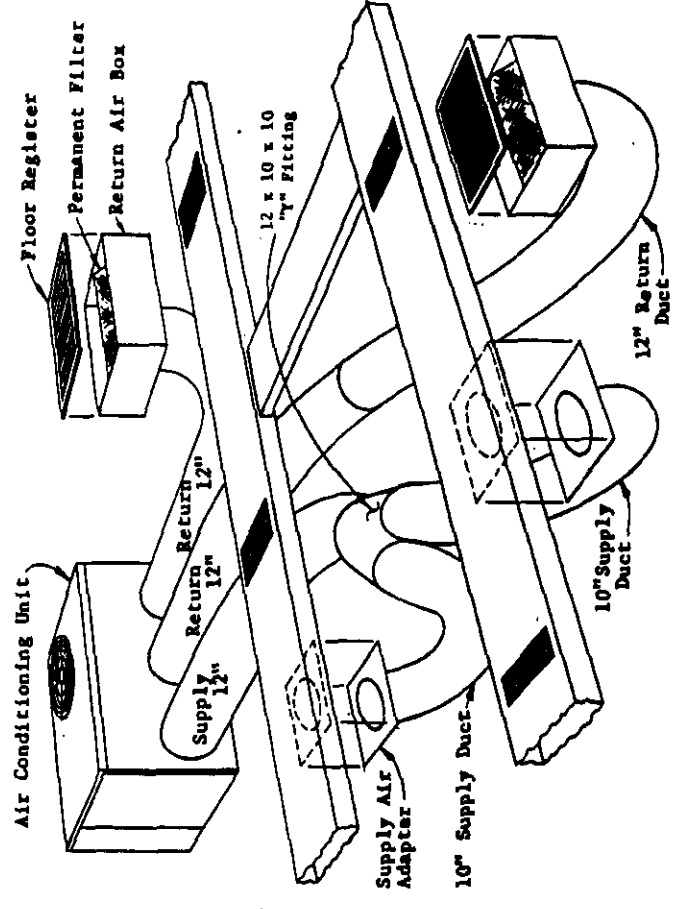

- Qty. 2 7001-014 Fitting Pack
 (1) 12 1/4 x 20 x 10 1/4 Return Air Box
 (1) 20 x 20 Permanent Filter
 (1) 12 x 20 Floor Register
 (1) 12" Supply Air Adapter

- Qty. 1 7001-015 Fitting Pack
 (1) 12 x 10 x 10 "Y" Fitting
 (2) 10" Supply Air Adapter

IMPORTANT: Two 12 inch diameter return air ducts must be installed. Ducts are not supplied as part of the basic unit (field supplied).

These curves are based upon 80°DB, 67°WB R.A. Temp. and Rated CFM (airflow) across the evaporator coil and should be used for reference purposes only. Special information can be found under section titled "Refrigerant Charge" elsewhere in manual. If there is any doubt as to correct operating charge being in the system, the charge should be removed, system evacuated, and recharged according to serial plate instructions.

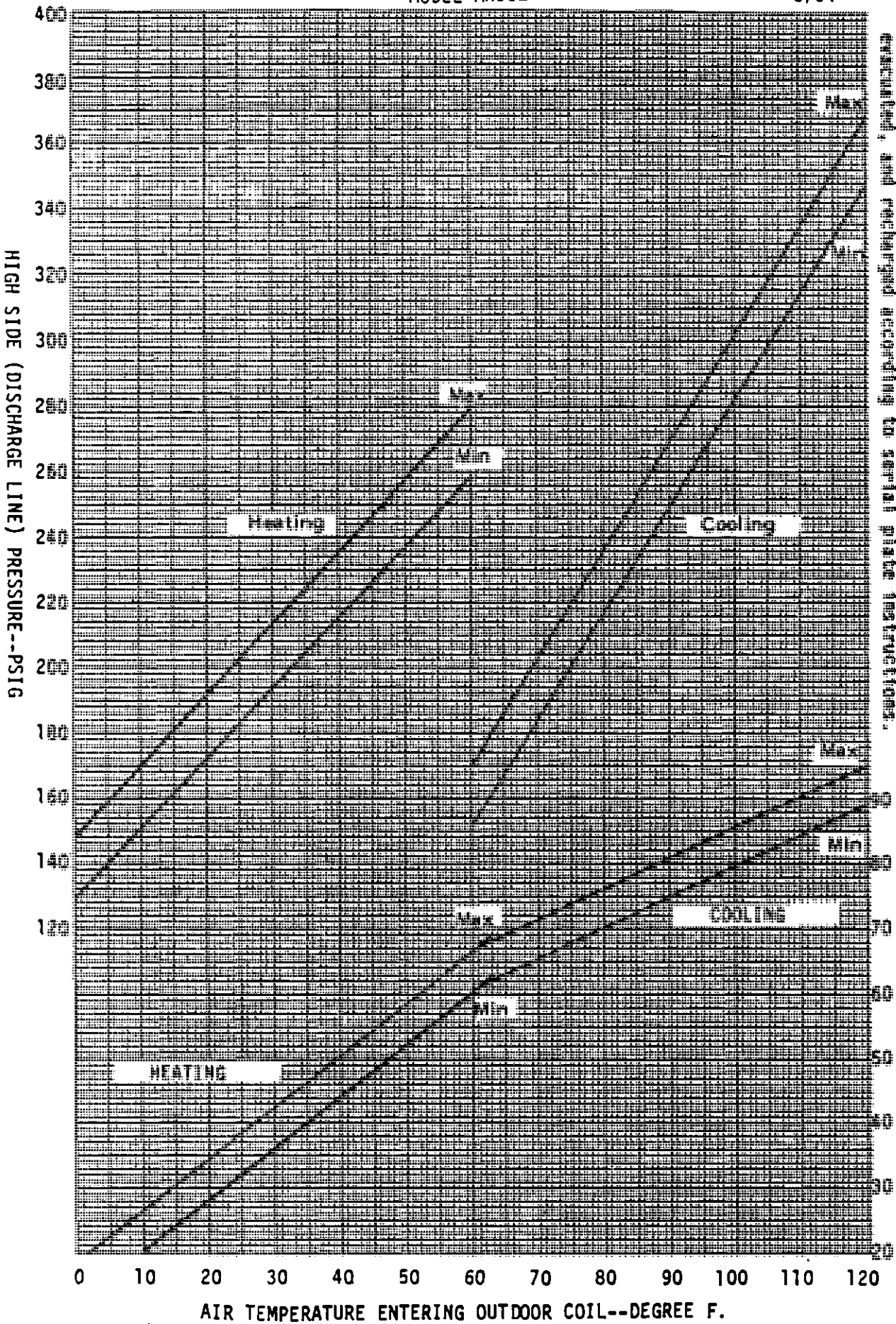

LOW SIDE PRESSURE--PSIG.
(SUCTION LINE)

MODEL MH36B

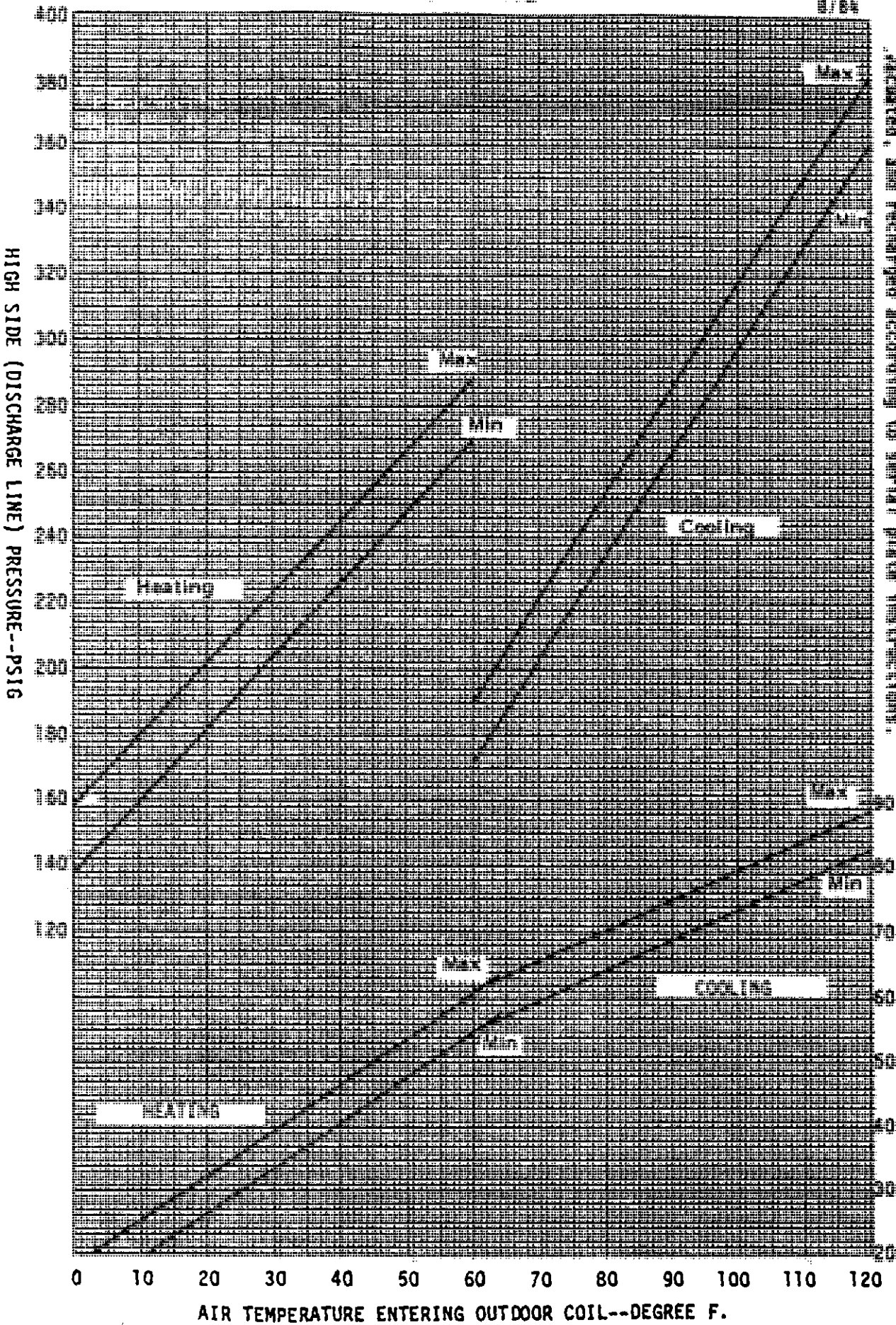

... section on 80°DB, 67°WB R.A. Temp. and P...
 across the evaporator coil and should be us...
 e purposes only. Special information can be...
 er section titled "Refrigerant Charge" elsewhere in...
 If there is any doubt as to correct operating charge...
 in the system, the charge should be removed, system...
 ulated, and recharged according to serial plate instructions.

LOW SIDE PRESSURE--PSIG
 (SUCTION LINE)

These curves are based upon 80°DB, 67°WB R.A. Temp. and Rated CFM (airflow) across the evaporator coil and should be used for reference purposes only. Special information can be found under section titled "Refrigerant Charge" elsewhere in manual. If there is any doubt as to correct operating charge being in the system, the charge should be removed, system evacuated, and recharged according to section titled "Refrigerant Charge".

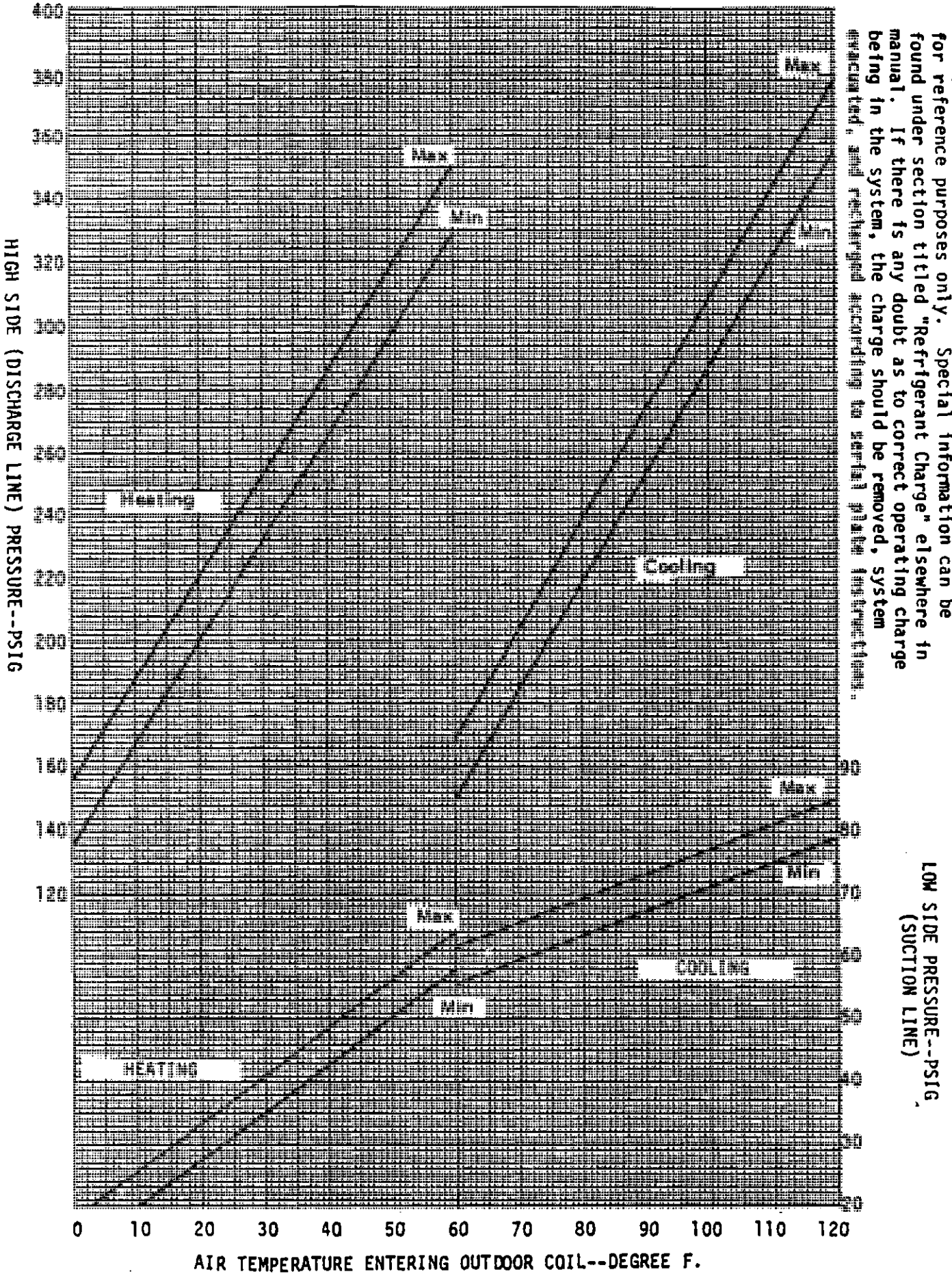

LOW SIDE PRESSURE--PSIG
(SUCTION LINE)

T874N1024/
Q674P1261
or
T874R1129/
Q674L1181

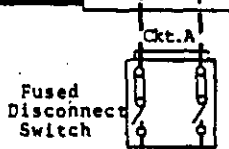
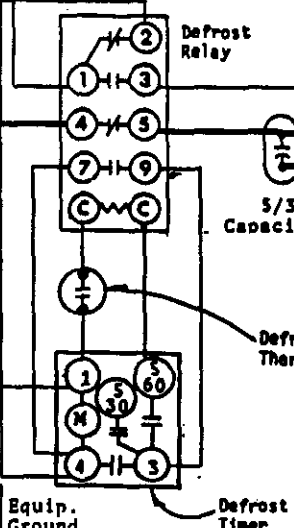
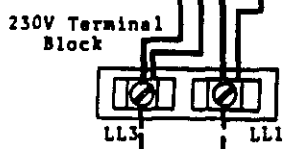
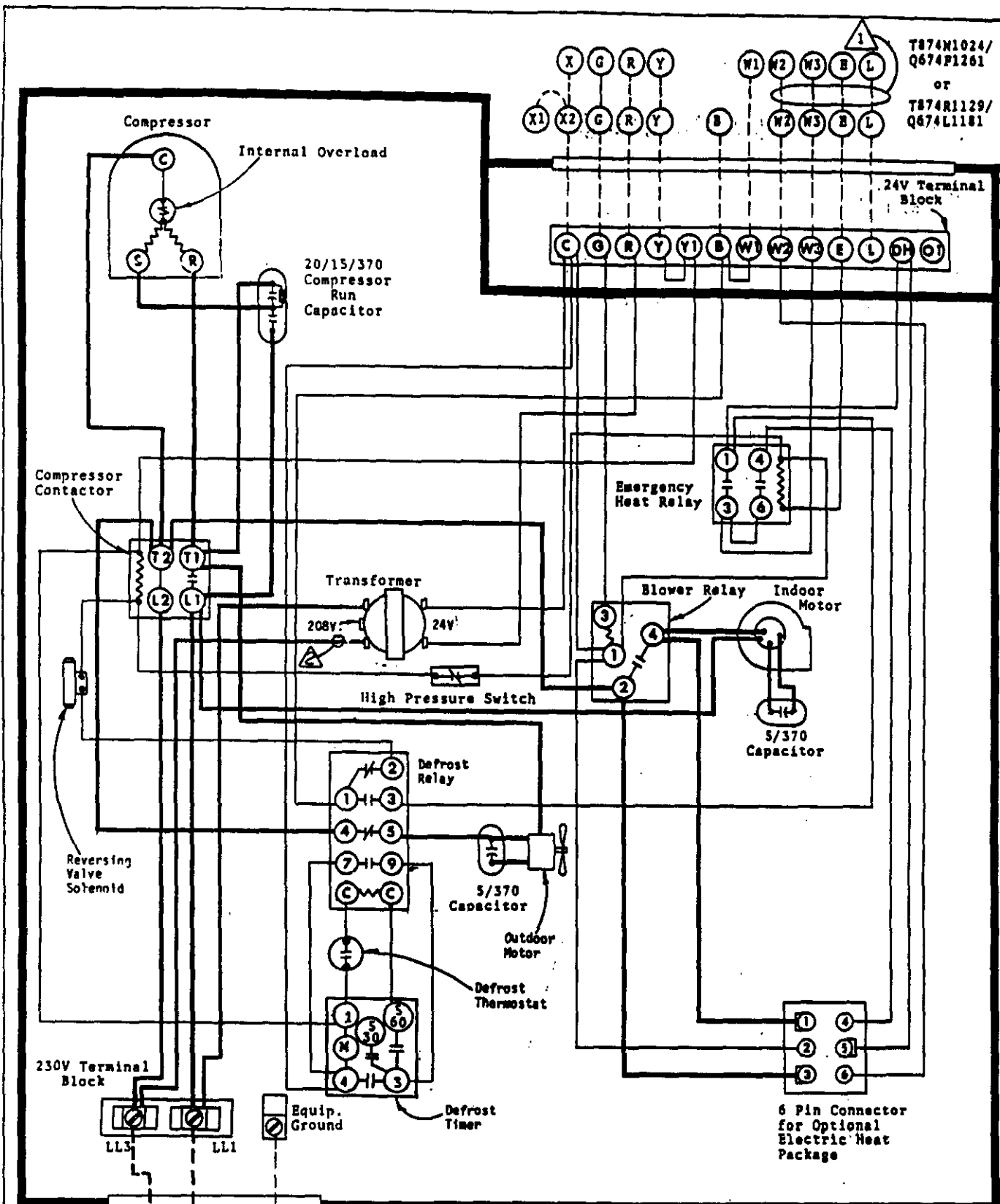

USE COPPER OR ALUMINUM WIRE

	FACTORY WIRING	FIELD WIRING
Low Voltage	————	- - - - -
High Voltage	————	- - - - -

- ⚠ Required only when optional electric heat package is installed.
- ⚠ For 208V operation move this wire to 208V transformer tap.

230/208-60-1

4059-110G

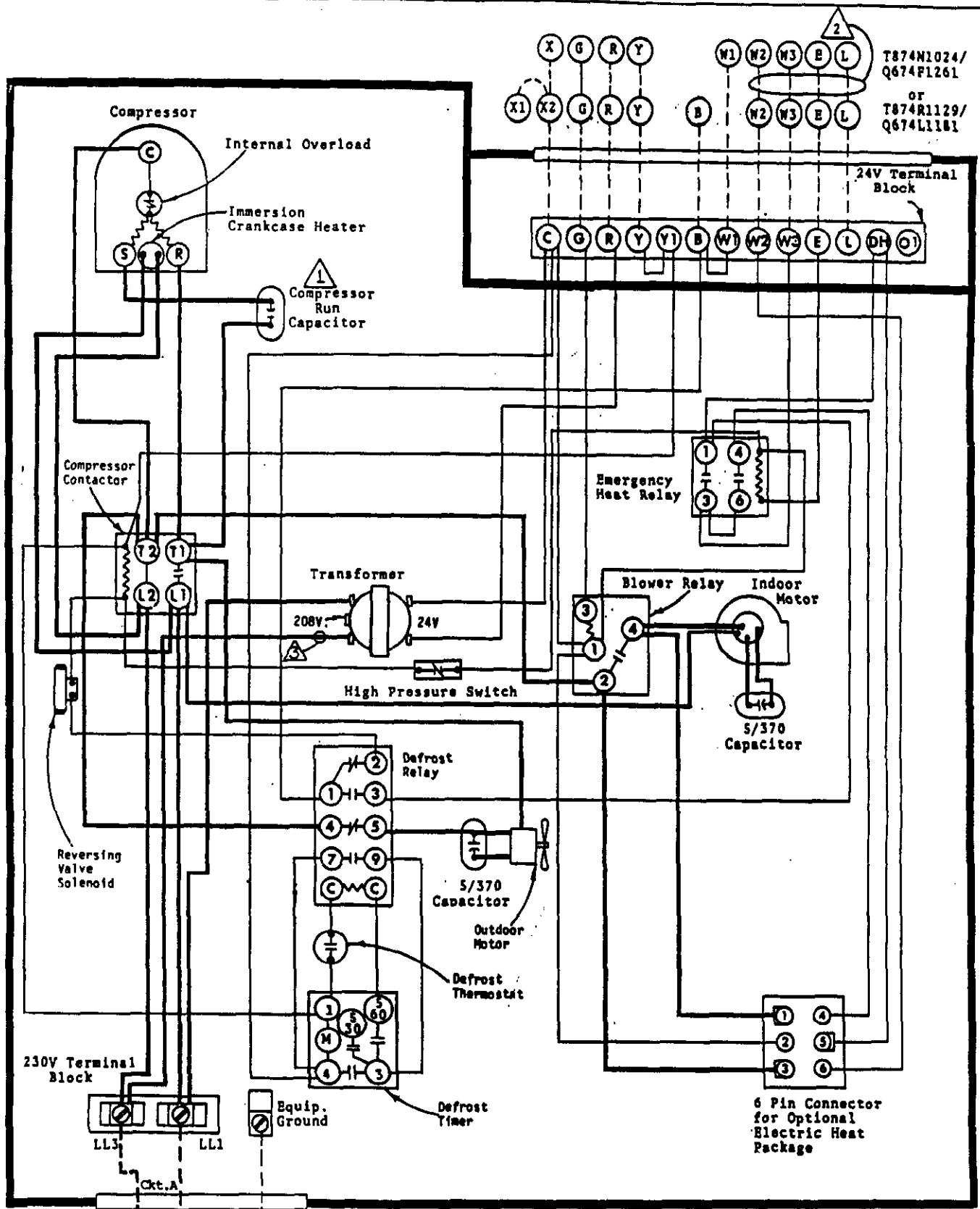

T874N1024/
Q674F1261
OR
T874R1129/
Q674L1181

USE COPPER OR ALUMINUM WIRE

	FACTORY WIRING	FIELD WIRING
Low Voltage	————	- - - -
High Voltage	————	- - - -

- ⚠ MH36A - 35/440 Cap.
MH42A - 40/440 Cap.
- ⚠ Required only when optional electric heat package is installed.
- ⚠ For 208V operation move this wire to 208V transformer tap.

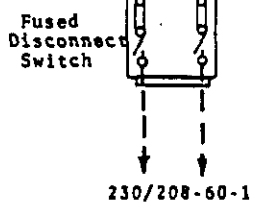

4059-120H

