Refrigeration, Heating & Air Conditioning

Thermostats



Bard Manufacturing Company
Bryan, Ohio 43506

*Since 1914...Moving, ahead just as
planned.*

Manual No.: 2100-053 Rev. A
Date: 09/18/95

Contents

Thermostats	1	Cooling Anticipator	6
Heating Thermostat	1	Heating-Cooling Thermostat	7
Temperature Indicator	2	Two-Bulb Thermostat	7
Bimetal Temperature Switch	2	System Switches	7
Switching Mechanisms	2	Terminal Letters	7
Enclosed Contact Switch	2	Staging Heating and Cooling	8
Mercury Switches	2	Two-Stage Thermostat	8
Dial Adjustment	3	Staging Heat	8
Differential	3	Outdoor Thermostat	8
The Thermostat and the System	4	Temperature Droop	9
Forced Warm Air System —		Setback Thermostat	9
Non-Anticipated Thermostat	4	Subbases	9
Forced Warm Air System —		Split Subbases	9
Anticipated Thermostat	5		
Types of Heat Anticipators	5	Calibration	10
How to Set an Adjustable Anticipator	5	Thermostat	10
Gas and Oil Furnace	5	Thermometer	10
Additional Information for Electric Heat or		Installation	10
Heat Pump Applications	6	Internal Wiring Schematics	12
Cooling Thermostat	6	Heat Pump Thermostat and Subbases	13

Thermostats

Heating Thermostat

A thermostat is an adjustable heat actuated switch. It automatically turns heating and air conditioning equipment on and off to maintain constant controlled temperatures within a building. It is the brain center of a home comfort center. For most homeowners, it is the only contact with the equipment which produces their indoor comfort.

The thermostat is a simple, yet highly-engineered device which allows the homeowner the capability to control his comfort destiny. The thermostat receives the homeowner's command and implements the command to maintain the comfort level. Many have a thermometer designed into the cover. The thermometer may be used as a guide when the heat actuated switch is adjusted.

In its simplest form, a thermostat is a device which responds to air temperature changes and causes a set of electrical contacts to "open" or "close". This is the basic function of a thermostat, but there are many different types designed to perform a variety of switching functions.

One of the early types of heating systems which was capable of some degree of automatic control was the hand fired coal furnace. Thermostatic control of this system was accomplished with a SPDT thermostat and a damper motor. The physical layout of this system is shown below:

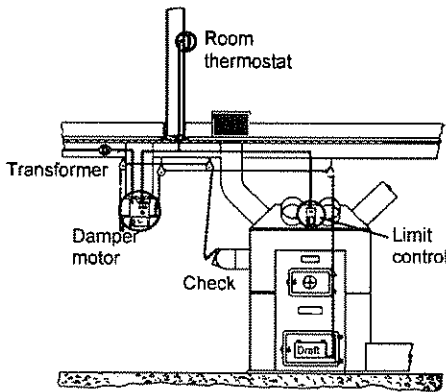

When the thermostat called for heat, the damper motor shaft would turn, opening the draft damper which would increase the combustion in the fire box. When the room thermostat was satisfied, the draft damper would close and the check damper would open which would tend to retard combustion. This was a long way from the completely automatic systems of today, but it was a beginning of automatic control for residential heating systems.

The bimetal room thermostat gets its name from the fact that it uses a bimetal to open or close a set of contacts upon an increase or a decrease in room air temperature. Just for the sake of review, let's look at how a bimetal works. A bimetal is two pieces of metal, which at a given temperature, are the same length.

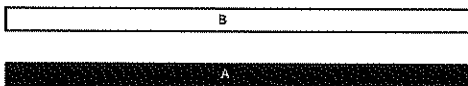

If we increase the temperature of these two pieces of metal, one will become longer than the other. This is because they are different metals having different rates of expansion.

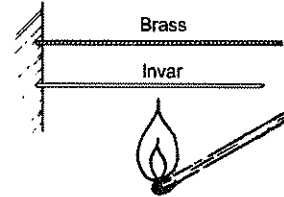

To make these two different metals work for us, we weld them together in such a way that they become one solid piece, but they still keep their individual characteristics of different rates of expansion.



Now when we apply heat, brass still expands at a faster rate than invar. In order for brass to become longer, it must bend the entire piece into an arc.

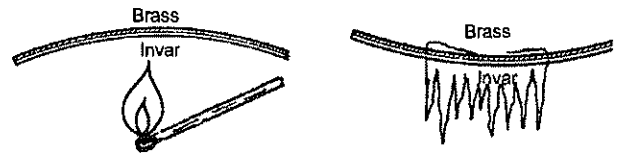

We now anchor one end of the bimetal to something solid, and the free end will now move down or up with an increase or decrease in temperature. By attaching contacts to the free end and placing other stationary contacts nearby, we can get different switching actions with changes in temperature.



In low voltage bimetal thermostats we want as much bimetal area as possible to be exposed to the changes in room air temperature. We do this by forming a long piece of bimetal into a small coil.

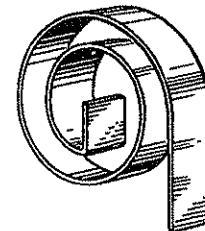

Bimetal devices are made in a variety of sizes, shapes, and configurations. The "U" in a "U" shape bimetal closes on a temperature rise and opens on a temperature fall. A spiral shape bimetal twists and untwists when the temperature changes. A cupped disc bimetal snaps and unsnaps; a bimetal coil winds and unwinds. Each shape has its particular advantage, depending upon where and how it is used.

The different bimetal shapes are used in various other heat sensitive, electrical switching devices such as limit overloads and relays. These various electrical components will be discussed in detail later.

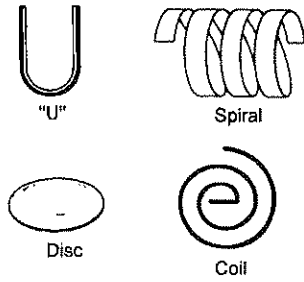

Temperature Indicator

When one end of the bimetal is anchored, the other will move up and down as the temperature increases and decreases.

When a temperature scale is placed at the free end, this bimetal can be used to indicate the temperature of the air. It then becomes a thermometer.

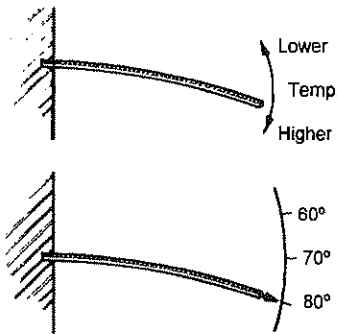

The thermostat utilizes the bimetal coil for both the temperature control setting and the room temperature indicator (thermometer).

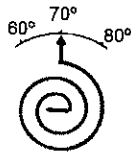

Bimetal Temperature Switch

The bimetal coil used in the thermostat for controlling the heating and cooling system has the advantage of being compact, yet extremely sensitive to small changes in temperature. Its light weight, surface area, and thinness cause it to react quickly to temperature changes in the air around it. The coiled bimetal can be anchored at either the inside or outside end. In most thermostats, it is anchored in the center. As the temperature changes, the coil winds and unwinds moving the outer end in an arc.

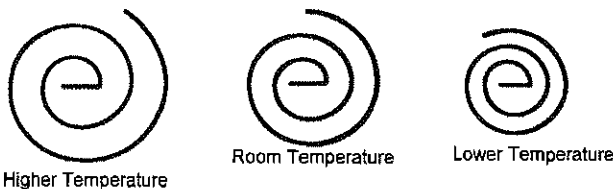

Switching Mechanisms

If an electrical contact is placed on the end of a bimetal, and the contact touches a fixed contact as the bimetal warps, the bimetal becomes a switch. The bimetal now has the capacity to automatically activate electrical devices as the temperature changes.

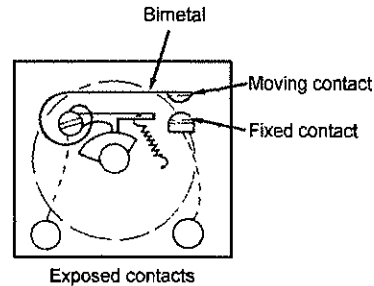

Enclosed Contact Switch

There are disadvantages, however, with the contact on the surface of the bimetal. Since the contacts are exposed openly on the surface, the contacts can become dirty. Oxidation and corrosion may also occur, hampering electrical conductivity producing an arcing effect.

Because of the problems of exposed contact, the enclosed contact switch was developed. The switch contacts are sealed in a glass tube to protect them from dust or moisture. The contacts open and close depending on the movement of a magnet, which is attached to the moveable end of the bimetal. The position of the magnet is controlled by bimetal responses to room temperature. There are also disadvantages to this type of switch. Besides the extra expense to make the switch operate, there is a risk of cracking the glass tube with all the moveable parts inside.

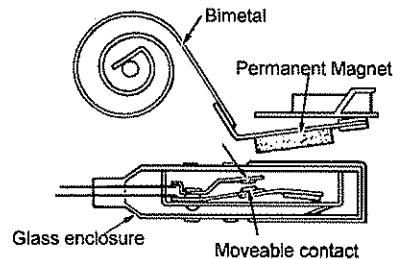

Mercury Switches

Another kind of switch which turns the furnace on and off is called a mercury switch or bulb.

The mercury switch consists of a sealed glass tube containing two electrodes and a small droplet of mercury. When this tube is tipped in one direction or the other, mercury flows to the lowest end.

When the mercury is at the end opposite the electrodes, the switch is open and no current can flow.

When the tube is tipped in the other direction, the mercury flows to the electrodes, making contact with both of them completing an electrical circuit. Mercury is an excellent electrical conductor; therefore, current can flow from one electrode to the other through the mercury. The switch is now closed.

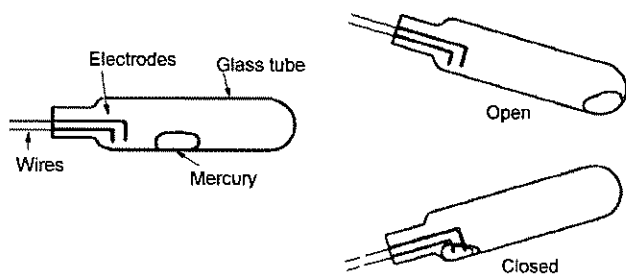

So that the switch can turn on and off with changes in temperature, it is mounted on the outside of the bimetal coil. When the coil winds and unwinds, it will tip the mercury bulb back and forth.

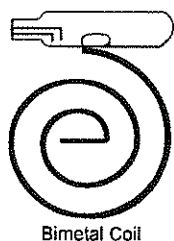

For example, when the temperature goes down, the coil winds up tighter, tilting the bulb so the mercury flows to the electrodes. This starts the furnace. The thermostat is said to be making a "call for heat".

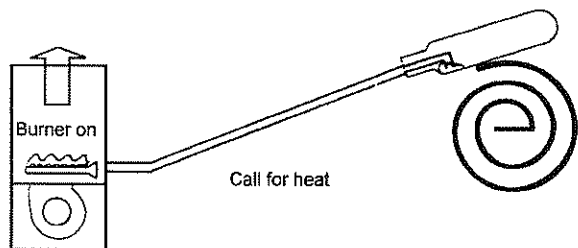

When the temperature goes high enough to cause the coil to unwind and tip the bulb in the other direction, the mercury flows away from the electrodes. The circuit is then opened and the furnace stops. The thermostat is then said to be "satisfied".

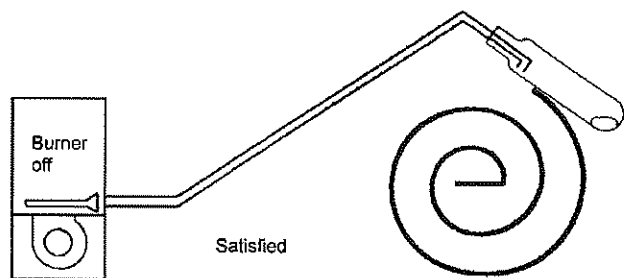

In order for the mercury switch thermostat to operate properly the thermostat must be level. The mercury switch is affected by gravity since gravity causes the mercury to flow from one end of the bulb to the other when tilted.

The mercury switch is not immune to malfunctions. The conductivity of the mercury can be adversely affected should the glass tube become cracked or if the thermostat is wired into the line voltage circuit. In either case oxidation, or "mercury distortion", can occur. When the film from oxidation builds up on the mercury and the mercury comes in contact with the electrodes, the film can cause an insulation effect on the electrodes which affects their operation.

Dial Adjustment

Because different people will prefer different room temperatures, an adjustment must be provided to keep the room warmer or cooler, as desired. This is done by providing a dial on the thermostat, which can be set to the temperature the homeowner wants to maintain. This dial is connected to the anchor of the bimetal coil.



When the thermostat is turned down to a lower temperature setting, it tips the coil. Now the coil must get cooler and wind up tighter before the furnace comes on.

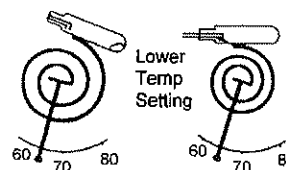

If a higher temperature is desired, the thermostat is turned up. This rotates the coil in the opposite direction so the furnace will run longer before the temperature gets high enough to unwind the coil and turn it off.

The thermostat, therefore, becomes an automatic switch turning the furnace on and off, allowing the homeowner to choose his own temperature.

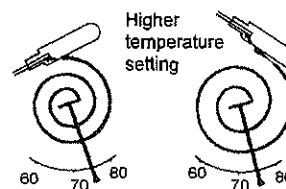

Differential

The thermostat will hold room temperature in agreement with the dial setting. However, a serious problem can take place within the thermostat. Vibration, even from a person walking across the room, can bounce the mercury bulb causing the furnace to cycle on and off rapidly (**fast cycle**) or **chatter**. This is hard on the furnace as well as the nerves.

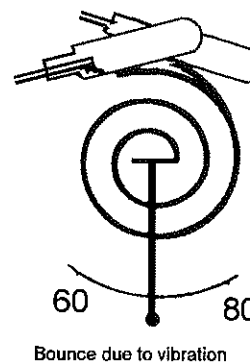

Bounce due to vibration

In order to overcome this problem, the glass bulb inside the thermostat is shaped slightly like a bean with a little hump in the center. The mercury must run over the hump when the bulb is tilted. It takes a little more tilt in either direction to get the mercury flowing from one end to the other. To achieve this extra tilt, the room temperature must be a little lower than the temperature setting to turn the furnace on, and a little higher to turn the furnace off.

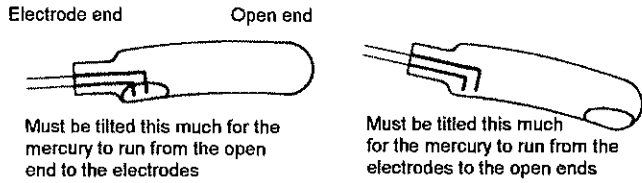

The weight of the mercury works in conjunction with the shape of the bulb to control vibration and chatter. The weight of the mercury delays movement of the bimetal. In terms of temperature, this means the bimetal coil must wind or unwind a little more to cause the bulb to tilt and the mercury to flow.

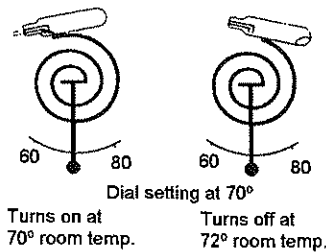

The shape of the bulb and weight of the mercury cause the thermostat to turn the furnace off at a higher temperature than it turns the furnace on. This built-in temperature difference is 2° and is called a **temperature differential** (see graph). If the temperature control setting is set for 68° F, the furnace will be turned on when the temperature falls to a temperature approximately 1° F lower than the set point. Therefore, a slight vibration and pounding won't cause the switch to rapidly open and close.

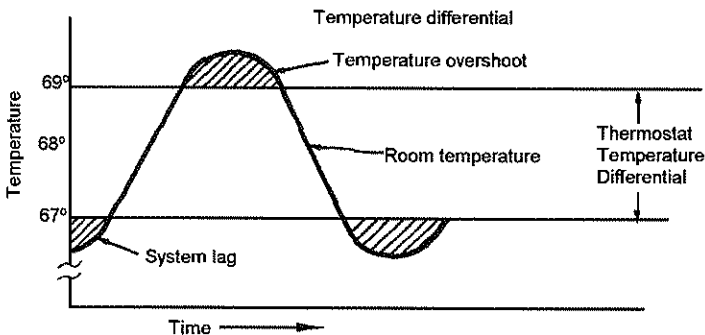

The Thermostat and the System

In any type of heating system, the success of the thermostat depends on several factors. First, the heating system must be of the right size (BTU output) to meet the needs of the area being heated. Second, the air distribution system must be properly designed and installed so that there is even air distribution to all rooms. Third, the thermostat must be located so that it can “feel” the **average** air temperature in the area being heated.

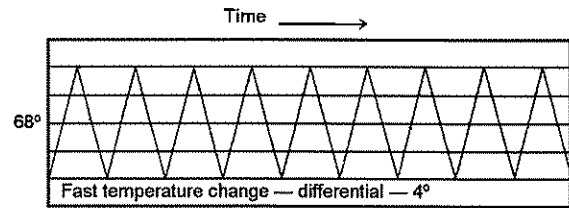

Figure 1

By having an improper balance of heating system size, thermostat location or air distribution we might expect a fast temperature change in the area being controlled. These conditions could result in a wide temperature differential as shown in Figure 1.

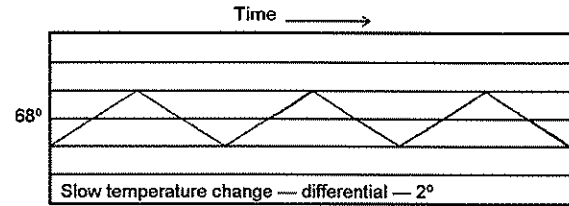

Figure 2

However, when we properly size the heating plant, balance the air distribution, and properly locate the thermostat, we will have a slower temperature change and thus a narrower differential as shown in Figure 2.

Forced Warm Air System — Non-Anticipated Thermostat

The temperature lever on the thermostat is set at 68° F, the furnace has been off for some time and the room air temperature is dropping slowly. The bimetal element has been following the air temperature change and will close the electrical contacts at 68° F. This causes the heating system to start. At this moment no warm air is being delivered to the room because the heating system must **warm-up** to the **fan-on** setting on the fan control.

While the heating system is **warming-up**, the room air temperature will continue to drop slowly. Depending on the type of heating system, the room air temperature will drop to 67-1/2° F, or 67° F or more before the blower comes on and the warm air is “felt” by the thermostat bimetal. This difference in temperature between the point at which the thermostat contacts close and the point the air temperature at the thermostat starts to rise is known as **system lag**. The amount of the **system lag** in degrees F will depend on the thermostat location, type and size of the furnace, and the design of the air distribution system.

With the furnace “on” and the blower running, the room air temperature will continue to rise. If the thermostat has a mechanical differential of 2° F, the electrical contacts will open at 70° F and shut down the primary control on the furnace. However, the furnace is still **hot** and the blower will continue to deliver warm air to the room until the furnace temperature drops to the **fan-off** setting on the fan control. The additional heat that has been delivered to the room after the thermostat contacts have opened is called **overshoot**. This “overshoot” can carry the room air temperature to 70-1/2° F, 71° F or higher.

The effect of **system lag** and **overshoot** are shown in Figure 3.

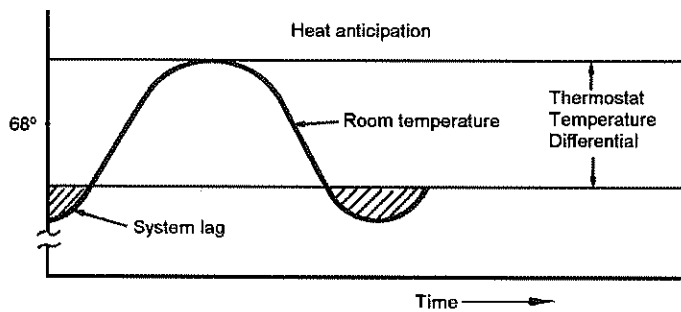

Forced Warm Air System — Anticipated Thermostat

To reduce the wide differential resulting from a nonanticipated thermostat, we simply add a small amount of heat to the bimetal element so that it is slightly warmer than the surrounding room air temperature. We do this by placing a resistor in the thermostat close to the bimetal element. This resistor in the thermostat close to the bimetal element. This resistor is in series with the contacts. When the contacts close and the primary control is energized, the current flowing through the primary control must also flow through the resistor. The current flowing through the resistor causes it to heat-up, which in turn heats the bimetal element. Thus, we **anticipate** the point at which the thermostat contacts should open to give us a narrow differential.

With the same setting of 68° F as in the previous example and the furnace **off**, the bimetal element temperature is dropping slowly. When the bimetal element temperature reaches 68° F, the contacts close, turning the furnace **on**. At this point the anticipating resistor begins to heat-up, which in turn heats the bimetal element.

The room air temperature will drop slightly before the blower comes on and warm air is delivered to the room. The room air temperature now begins to rise, but the bimetal element is warmer than the surrounding air due to the heat from the anticipating resistor.

With the same mechanical differential of 2° F, the thermostat contacts will open when the heat from the anticipator raises the bimetal temperature to 70° F. The room air temperature at this point may be 68-1/2° F and rising.

Because the furnace has been **on** a shorter period of time, there is less heat left in the heat exchanger. This means we will have less **overshoot**. In the meantime, the bimetal element is cooling down because it is no longer being heated by the anticipator. Thus, we begin the cycle all over again.

We have not eliminated **system lag** or **overshoot**, but through the use of **heat anticipation** we reduce these factors to the negligible point.

Types of Heat Anticipators

Heat anticipators are made in two types: fixed and adjustable. A fixed anticipator can be either wire wound or the carbon resistor type. Fixed anticipators must match the current draw of the primary control. A number of different ranges are available. The most versatile heat anticipator is, of course, the adjustable type.

How to Set an Adjustable Anticipator

The primary purpose of the adjustable anticipator thermostat is to provide a single thermostat to match almost any type of primary control in the field today.

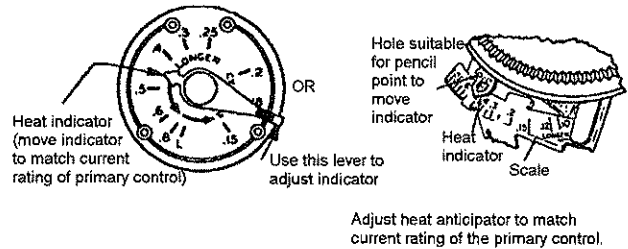

Adjust heat anticipator to match current rating of the primary control.

The adjustable heat anticipator has a slide wire adjustment with the pointer scale marked in tenths of an ampere. This is used to set the anticipator to agree with the control amp draw of whatever furnace might be used, gas, oil, or electric.

If the primary control nameplate has no rating or if further adjustment is necessary, use the following procedure to determine the current draw of each stage.

The current draw of each heating stage must be measured with the thermostat removed and the power on.

1. Connect an ac ammeter of appropriate range between the heating terminals of the subbase.
Stage 1 — between W1 and RH or R;
Stage 2 — between W2 and RH or R.
2. Move the system switch to **heat** or **auto**.
3. After one minute, read the ammeter and record the reading.
4. After mounting the thermostat, set the adjustable heat anticipator(s) to match the respective reading(s) measured in step 3.

Gas and Oil Furnace

If you want to change the cycle for the heating system, you can make a simple adjustment on the anticipator to do this.

Additional adjustment, if necessary, may be made as follows:

Burner cycles too short — set adjustable heater to a slightly higher dial setting (1/2 division).

Burner cycles too long — set adjustable heater to a slightly lower dial setting (1/2 division).

Occasionally you may find a system where longer or shorter cycles of the primary control are desirable. If the primary control draws .45 amps and you want a longer cycle, set the anticipator to .5 or .6 amps. This puts less resistance in the circuit. With less resistance, but the same current (from the primary control), you will generate less "false" heat and get a longer cycle of the primary control.

If a setting of .45 amps on the adjustable anticipator gives a cycles that is longer than desired, reset the indicator to .3 or .25 amps. This will put **more** resistance in the circuit and thus generate more **false** heat for shorter cycles.

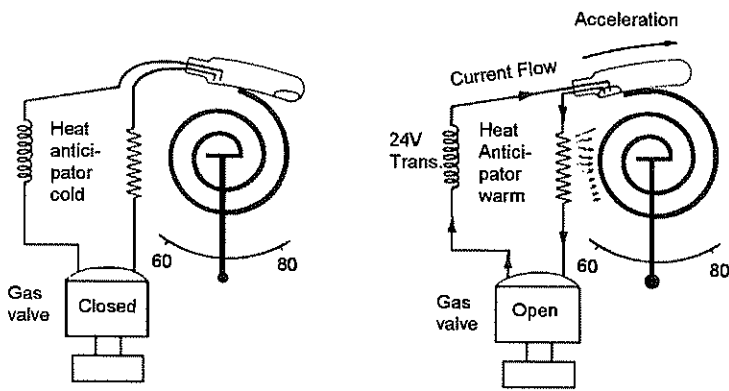

The heat anticipator is connected electrically in series with the gas valve in a gas furnace, the primary control in an oil furnace, and with the heat controls in an electric furnace.

Additional Information for Electric Heat or Heat Pump Applications

Adjust heat anticipator to match current rating of heating relay for W1 (and W2 if 2-stage). Move indicator on the scale to correspond with this current rating.

If the current rating is not given, proceed as follows:

1. Wrap exactly 10 loops of thermostat wire (W1) around the prongs of an Amprobe.
2. Let the heating system operate for one minute before reading the W1 or W2 current draw.
3. Divide the reading obtained in step 2 by 10.
4. Use the value calculated in step 3 to set the heat anticipator.
5. Repeat the procedure for (W2) if 2-stage heat.

NOTE: Cooling anticipators on all thermostats are fixed and do not require setting.

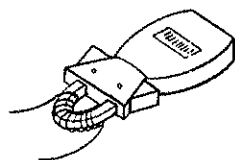

Example: $\frac{6.0 \text{ amps}}{10 \text{ loops}} = .6 \text{ A}$

Cooling Thermostat

Thermostats not only control the heating system (furnace), but control the cooling system (compressor, condenser coil, and evaporator coil) as well.

The theory of a cooling thermostat is simple to understand: reverse the position of a mercury switch on the bimetal coil. Now when the coil heats up and unwinds, the mercury switch closes its contacts starting the compressor in the condensing unit.

When the cooling thermostat is turned down to make the air cooler, it tips the mercury bulb so that the coil must cool more and wind tighter to turn the cooling system off.

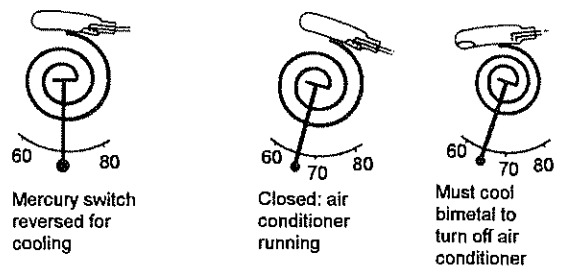

Cooling Anticipator

Like the heating thermostat, the cooling thermostat is equipped with an anticipator. It is called a **cooling anticipator**. It does the same job as a heating anticipator.

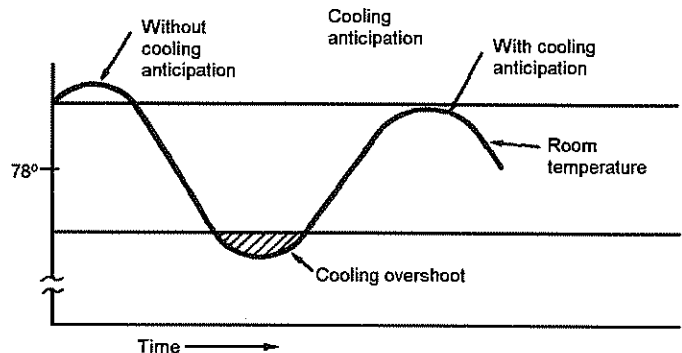

Cooling anticipation like heating anticipation allows the room temperature to be controlled within plus or minus one degree.

The anticipator is a small fixed resistor wired in parallel with the cooling mercury switch. When the switch is closed during a cooling demand, the anticipator is parallel and bypassed. At the same time, the mercury switch energizes the compressor contactor to run the cooling system.

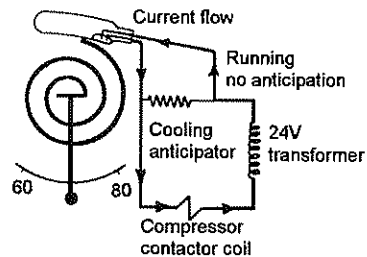

When the cooling demand is satisfied, the mercury switch opens. This puts the cooling anticipator in series with the compressor contactor coil. A very small current flows through both the coil and resistor. The amperage is not enough to pull the coil, but is sufficient to cause the resistor to heat up. The heat generated by the resistor fools the bimetal coil into thinking there is a call for cooling before the room temperature rises to the dial setting of the thermostat. The cooling anticipator compensates for the lag between the time of the call for cooling and when the system begins to cool the room.

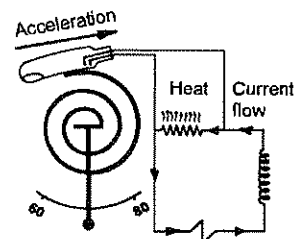

Heating-Cooling Thermostat

When heating and cooling are combined for year round comfort, it would be impractical to use a separate thermostat for each. Therefore, the two are combined into one **heating-cooling thermostat**.

Two-Bulb Thermostat

Now that the heating and cooling thermostats have been covered individually, the next step is to combine them into a single thermostat for year round control.

The bulk and expense of two separate bimetal coils, one for heating and one for cooling, is avoided when two mercury bulbs are mounted on the same bimetal coil. This results in the assembly illustrated below.

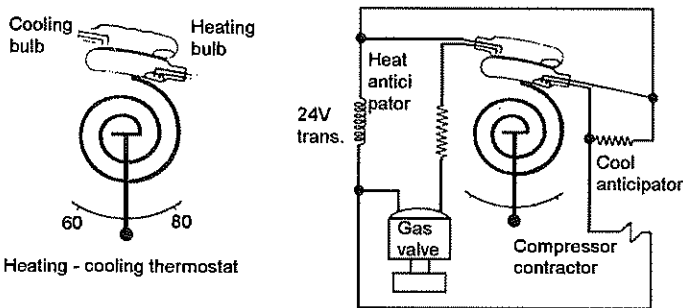

The heating and cooling anticipators are mounted near the coil. A single transformer is used as illustrated on the diagram.

The two mercury bulbs can be combined into one. This is done by using one common electrode, one heating electrode and one cooling electrode as illustrated. When the bulb is tilted in one direction, it closes the heating contacts, and in the other direction, the cooling contacts are closed.

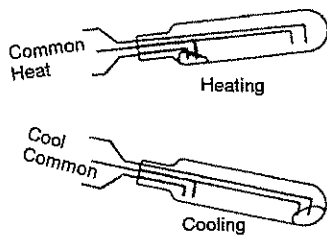

System Switches

Unless a switch is provided in the heating-cooling thermostat, the thermostat will continuously switch back and forth from heating to cooling. In effect, the heating and cooling will fight a battle with each other. The switch provides a means to throw control to cooling, for example, while disconnecting the heating circuit.

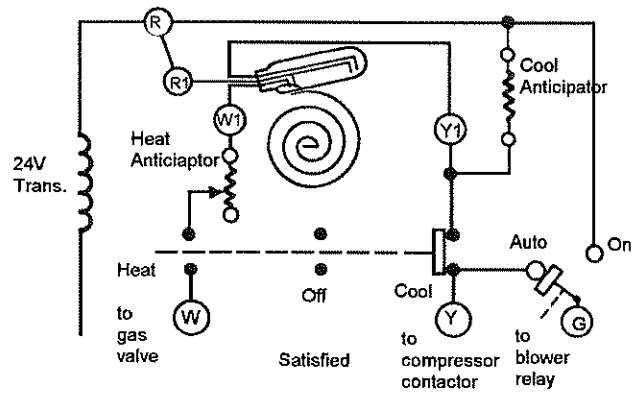

Likewise, when the switch is moved to heating, the switch connects the heating components while electrically isolating the cooling circuit. When the switch is in the center **off** position, neither the heating nor cooling circuits are energized.

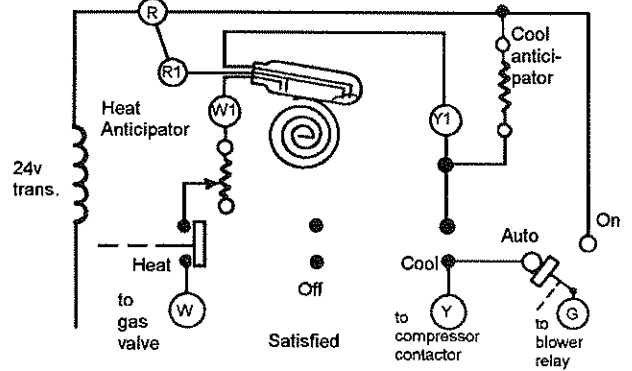

Many thermostats — heating, cooling, or combination — are equipped with a fan switch. The purpose of this switch is to allow the homeowner to control the blower operation independently of the **cool-off-heat switch**.

When this **fan** switch is at **auto**, the blower runs only when there is a call for heating or cooling. When a thermostat is satisfied, the blower shuts off. The continuous blower position is normally marked **on**. When this switch is turned to **on**, the blower will run all the time.

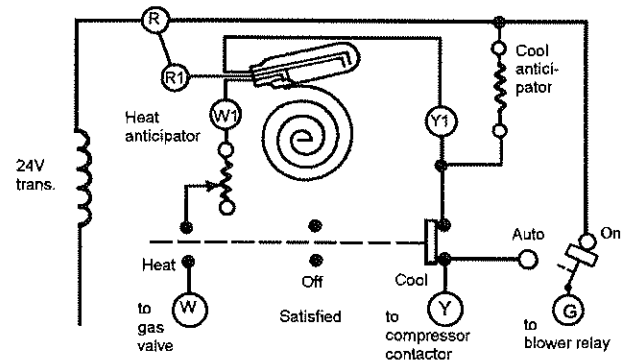

Terminal Letters

The lettered terminal designations are typical of those used on some thermostats. Other thermostats may use different letters to denote terminal connections, but these are called out in the

thermostat installation instructions. The instructions also include the thermostat wiring diagram.

Some Common Thermostat Terminal Markings

MODEL	COMMON	COOLING	HEATING	FAN
IF56	R	Y	W	G
T87	R	Y	W	G

Staging Heating and Cooling

The staging of heating or cooling is a way to align furnace and cooling unit capacities with comfort requirements. Heating and cooling units are applied so enough heating or cooling is available for the most extreme weather condition. Weather conditions are variable, falling short of the design (peak) condition of the unit a majority of the time. Indoor comfort conditions depend upon the outdoor temperature. Staging allows the unit flexibility in satisfying indoor comfort requirements, by compensating for the heat loss and heat gain of a structure caused by changing outdoor temperatures. When operating below design conditions, heating can be delivered in several stages, greatly reducing energy consumption of the unit. Cooling, likewise, can be broken into two stages. The brain center of this energy saving operation is the two-stage thermostat.

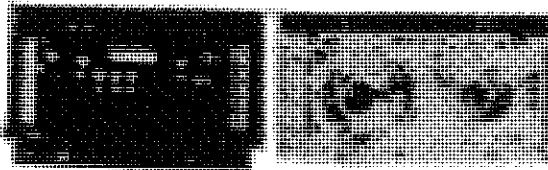

Two-Stage Thermostat

The two-stage thermostat, like the heating-cooling thermostat, has two bulbs mounted on the same bimetal coil. They are mounted at slightly different angles so one mercury switch closes before the other. One bulb energizes the first stage. On continued demand, the second bulb energizes the second stage.

Staging Heat

The first stage of heat satisfies the thermostat demand when the heat delivered is greater than the heat loss of the structure. As outside temperature drops, the heat loss of the structure increases. When the room temperature decreases by an amount equal to the temperature differential between stages of heat (approximately 2°), a second mercury switch closes its contacts in the thermostat. The second stage of heat is energized. In the staging of heat, as extra stages are needed, they are energized in addition to the first stage. Demand satisfied, the second stage of heat deenergizes. Regardless of outdoor thermostat temperature, the last stage of heat energized is always satisfied before the previous stage. Each thermostat bulb has its own heat anticipator. Since the bulbs work independently, their anticipators may have different settings. Amperage draw for each must be measured separately. Their adjustable anticipators are set accordingly.

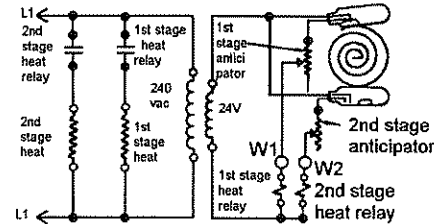
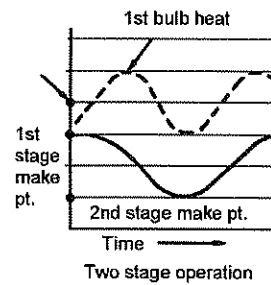

Outdoor Thermostat

The outdoor thermostat is used in conjunction with either a single-stage or two-stage indoor thermostat to match the heat output of an electric furnace to the heat loss of the conditioned space based upon outdoor air temperature. The outdoor thermostat, as its name implies, is used in order to monitor the outdoor air temperature. More heat is required in a conditioned space if the outdoor air temperature is colder.

The outdoor thermostat is a 24-volt, bellows switch. The thermostat set point is manually adjusted and is normally set to a temperature where the heat loss in the house cannot be handled by the previous heating stages.

The function of an outdoor thermostat is similar to that of a two-stage room heating thermostat. When the outdoor temperature falls below the outdoor thermostat set point, the pressure in the bellows also drops causing the bellows switch to collapse. This closes the thermostat's contacts and energizes additional heating elements. The previous heat stages are cycled on and off by the indoor thermostat. As long as the outside temperature is above the set point of the outdoor thermostat, the previous stages should be able to satisfy the heat requirements of the conditioned space. The outside thermostat cannot energize the additional heat elements unless the room thermostat is calling for heat, and the outside temperature is below the set point of the outdoor thermostat.

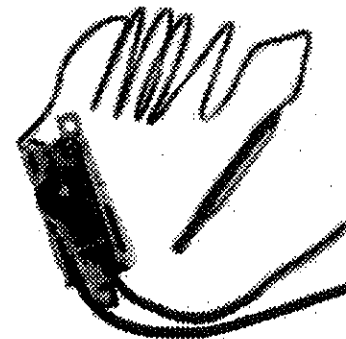

Temperature Droop

Because of several factors, the average temperature in a conditioned space may be lower than the set point of the indoor thermostat. The difference between the set point of the indoor thermostat and the average room temperature is called **temperature droop**. The extent of the temperature droop is dependent upon the severity of outdoor temperatures and the ability of the heating system to respond to these conditions.

As discussed earlier in this section, there is a time lag between the call for heat by the thermostat and the delivery of the heat to the space.

As the outdoor temperature falls, the rate of heat loss from the space will increase. Since the heat delivery time lag remains the same and the rate of heat loss increases, the temperature droop will increase. During certain conditions, the temperature droop, or difference between the thermostat set point and average temperature of the space, can be as much as 7° or 8°. Innovations are continuing in thermostat design. Some now have accessory outdoor air temperature sensors that can aid in compensating for the droop factor.

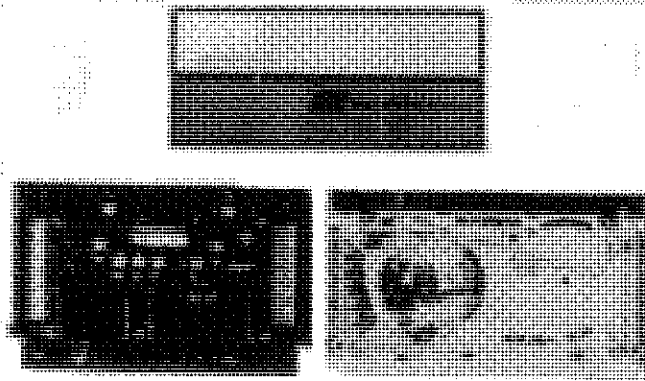

Setback Thermostat

The automatic setback thermostat is an energy-saving device that permits the homeowner to select temperatures for certain periods of low demand during the day. This means real fuel/energy dollar savings for the heating and cooling season. **Not recommended for heat pumps.**

A quartz clock allows the homeowner the flexibility to change heating temperature periods two times every 24 hours. The quartz clock is set for the times the desired temperatures are to go into effect. There is also a high temperature lever and a low temperature lever. These are set for the high and low temperature changes to be used during a 24-hour period.

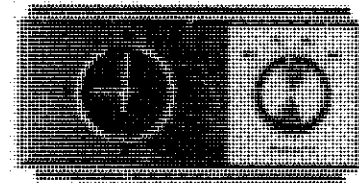

The setback thermostat also allows cooling setups and setbacks during the cooling season. This feature allows the homeowner to set up the temperature during the daytime when the home is unoccupied. The thermostat then automatically lowers the temperature before the homeowner returns in the evening.

Subbases

Many thermostats are designed for use with subbases. A subbase is a plate or bracket which mounts on the wall. Thermostat wiring connections are made to it. The thermostat is screwed onto the subbase. These screws complete the electrical connections between thermostat and subbase.

In some cases the subbase contains the **cool-off-heat** switch and the **fan** switch.

Split Subbases

The split subbase is designed for heat pumps and larger commercial equipment with a greater number of control voltage loads. The split subbase has two input terminals. This allows the use of two transformers if needed.

Calibration

Thermostat

T874 thermostats are accurately calibrated at the factory. They do not have provision for field calibration.

The T87F is calibrated at the factory and no recalibration should be necessary. If the thermostat is accurately leveled and still appears to be out of calibration, order 104994 Calibration Wrench. Instructions for recalibrating are furnished with the wrench.

Thermometer

1. Remove thermostat cover by pulling up from the bottom of cover until it clears the cover clip.
2. Set the cover on a table near an accurate thermometer.
3. After allowing 5 or 10 minutes for stabilization, compare the readings. If they are the same, replace cover and put system into operation. If they are different, recalibrate the thermostat thermometer, Step 4.
4. Insert a small screwdriver in the thermometer shaft (Figure 4) and turn it until the thermometers read the same. When the thermometer is calibrated, replace cover and place system into operation.

NOTE: Hand heat will offset the thermometer reading. After making each adjustment, wait 5 or 10 minutes for the thermometer to stabilize before comparing.

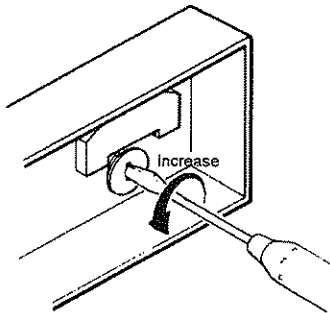

Figure 4 — Thermometer Calibration

Installation

The best, most sensitive thermostat cannot do its job properly if it is poorly installed. A few of the do's and don'ts for the installation of a thermostat are:

1. Level the thermostat carefully. This is more important because the mercury switch is affected by gravity. Gravity causes the mercury to flow from one end of the bulb to the other when tilted.



Important

A subbase incorrectly leveled will cause the temperature control to deviate from set point.

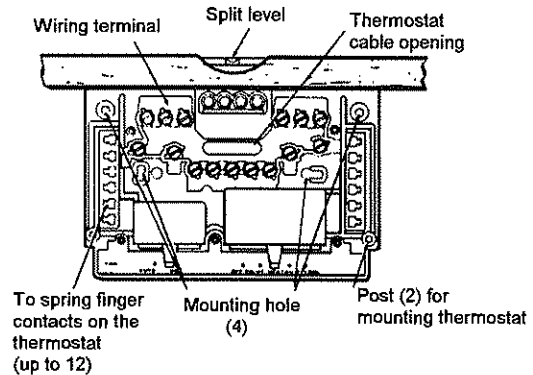

2. Locate the thermostat on an inside wall which remains close to the indoor temperature. The surface of an outside wall is cooler than room temperature in winter and warmer in summer. The thermostat bimetal senses this and is thrown out of temperature balance with the room air.

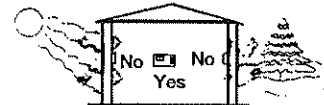

3. Place the thermostat away from drafts. If it is opposite an outside door or near an air register, it will swing far out of temperature balance with the room air.

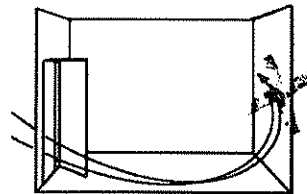

4. Locate it on a solid wall which is not affected by vibration from appliances or slamming doors or stairways.

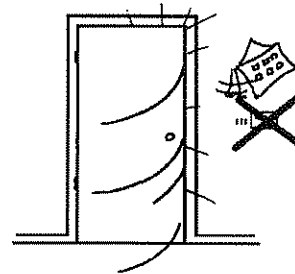

5. Locate the thermostat 4 to 5 feet above the floor so that it regulates temperature at the living level. Usually, the air near the floor is slightly cooler and the air near the ceiling slightly warmer than the average room air.

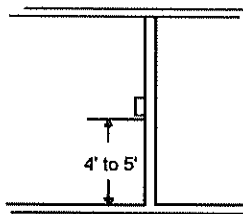

6. Do not locate it in a wall where it is affected by temperature from air ducts, water pipes, or a chimney within the wall.

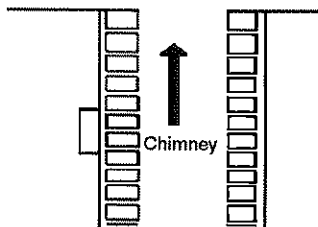

7. Do not place it where it can be affected by sunlight during any part of the day.

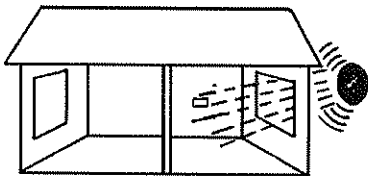

8. Do not locate it where the free circulation of air to it is blocked by a ledge or shelf directly above or below it.

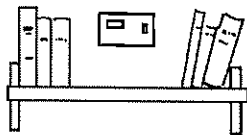

9. Do not place a lamp, television set or other heat producing appliances beneath the thermostat.

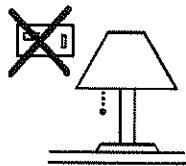

10. Seal the wiring opening in the wall behind the thermostat so it is not affected by drafts within the wall stud space.



11. Do not place on a heavy wall, such as brick, which acts as a heat sink and slows down the response of the thermostat.



12. Finally, make all wiring connections clean and secure.

Internal Wiring Schematics

8403-002 (T87F) thermostat with 8404-003 (Q539A) subbase

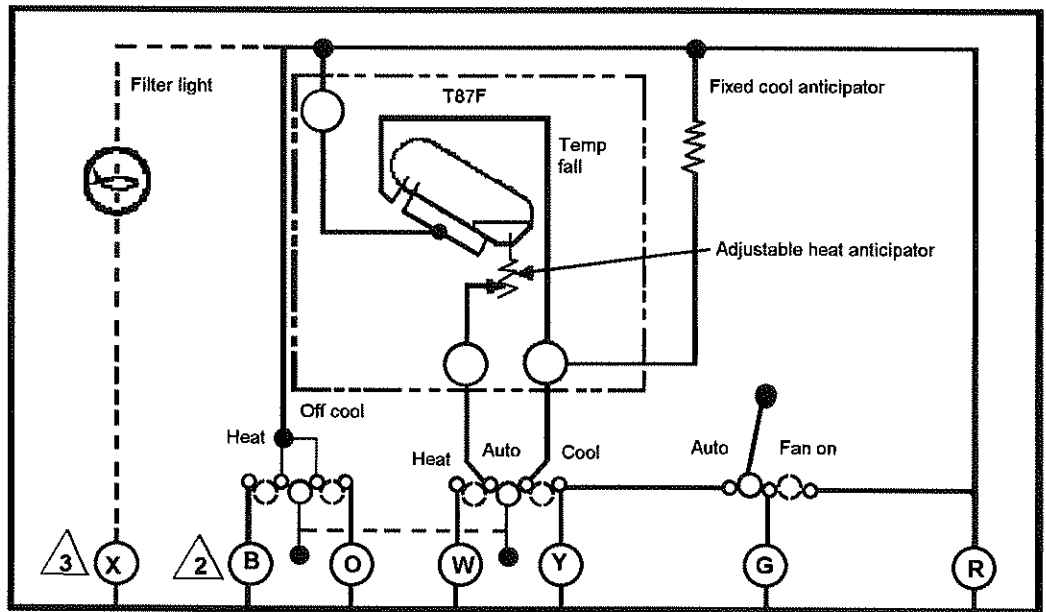

- ⚠ No. 4 terminal is the same as B terminal.
- ⚠ X terminal used on Q539 models with factory installed malfunction light.

T87F thermostat with Q539A1220 subbase

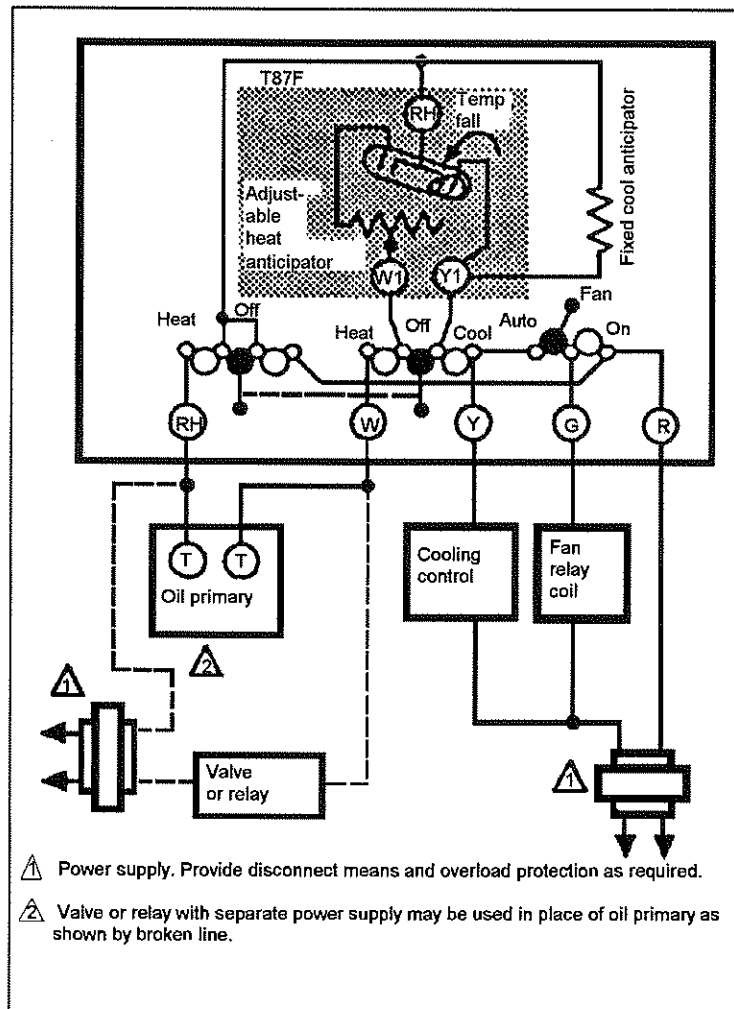

- ⚠ Power supply. Provide disconnect means and overload protection as required.
- ⚠ Valve or relay with separate power supply may be used in place of oil primary as shown by broken line.

Heat Pump Thermostat and Subbases

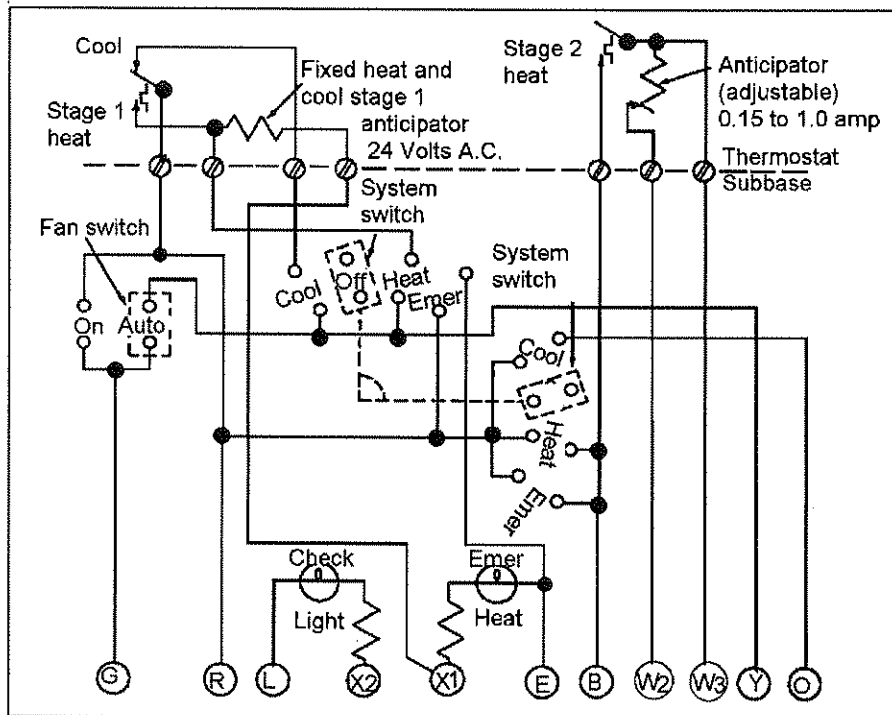

IF58 heat pump thermostat
with subbase

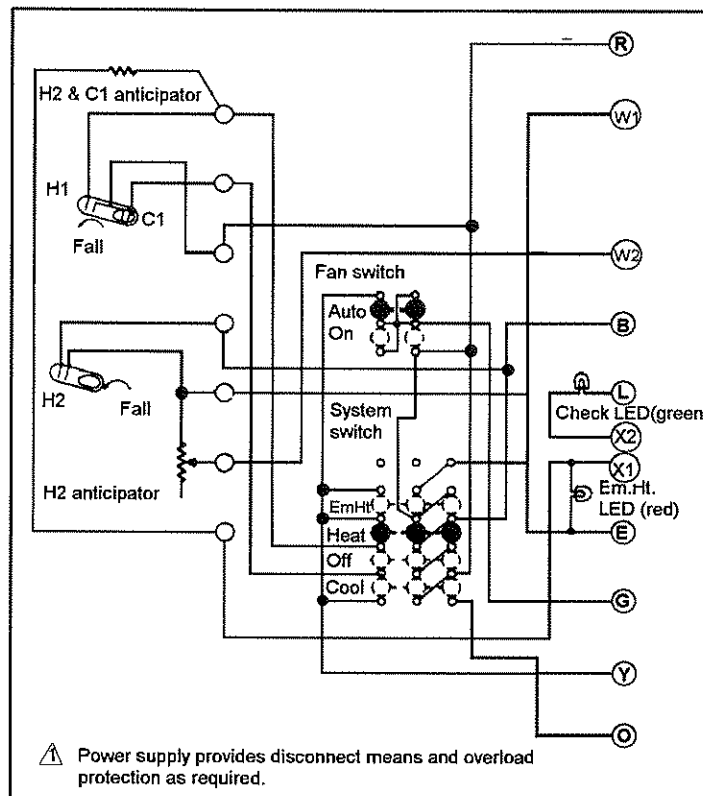

8403-017 (T874R) thermostat with
8404-009 (Q674L) subbase