

# INSTALLATION INSTRUCTIONS

ECONOMIZER

MODEL ECON-P-35

WITH PD-3A AND PD-5A ECONOMIZER DAMPERS

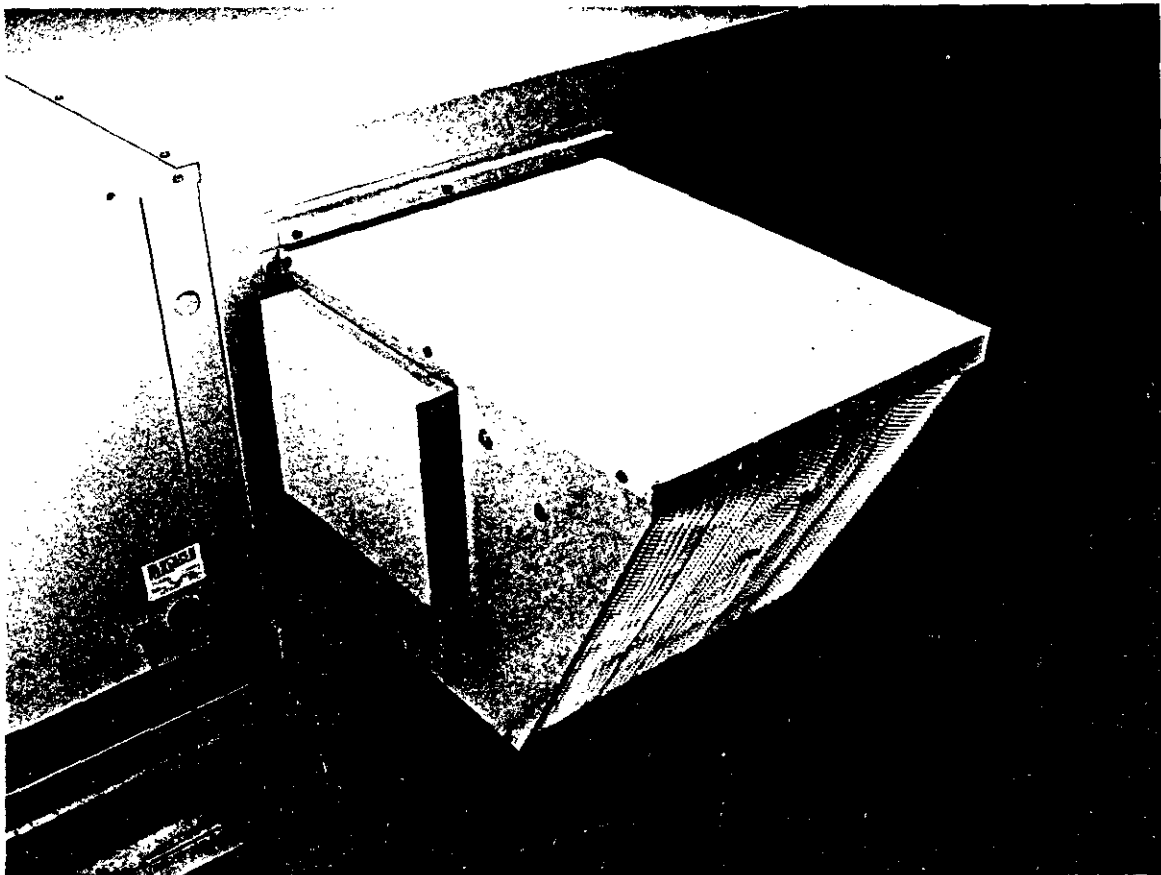



# INSTALLATION INSTRUCTIONS ECON-P-35 ECONOMIZER WITH PD-3A AND PD-5A ECONOMIZER DAMPERS

## GENERAL INFORMATION

The Economizer should only be installed by a trained heating and air conditioning technician. These instructions serve as a guide to the technician installing the Economizer package. They are not intended as a step-by-step procedure with which the mechanically inclined owner can install the package.

## UNPACKING

Upon receipt of the equipment, the cartons should be checked for external signs of shipping damage. If damage is found, the receiving party must contact the last carrier immediately, preferably in writing, requesting inspection by the carrier's agent.

## DESCRIPTION

The ECON-P-35 Economizer with either the PD-3A or PD-5A damper assembly is an electrical mechanical economizer system designed to provide "free" cooling where the outdoor air temperature is cool enough to provide the needed cooling without running the compressor. When cooling is needed, the system automatically takes advantage of the cool outdoor air when available and uses it for first stage cooling. This then reduces the need to run the air conditioning compressor providing lower operating costs and increasing the service life of the equipment. If the outdoor air gets too warm or humid to be helpful, the enthalpy control detects this condition and automatically closes the outdoor air damper and opens the return air damper and switches to the compressor operation. This is all done automatically to achieve maximum savings without attention from the user.

The model ECON-P-35 economizer package is designed to be used with the packaged air conditioners (P-series 2-1/2 thru 5 ton) and packaged heat pumps (PH-series 2-1/2 thru 5 ton). It must be used with the new RHE36 (2-1/2 or 3 ton) or RHE60 (4 or 5 ton) roof hood. It may optionally be used with the 9042-003 (P36 curb) or 9042-004 (P60 curb), galvanized steel roof curbs to provide a good, easy to install, labor-saving and troublefree installation.

The economizer is shipped in two sections. One contains the basic economizer package which includes the economizer, enthalpy control, multi-stage thermostat, subbase, damper linkage, outdoor air damper, left-hand crank arm and all necessary hardware items. Shipped separately is either an 18" x 30" damper, PD-3A (for 2-1/2 or 3 ton units) or an 18" x 42" damper, PD-5A (for 3-1/2, 4 or 5 ton units).

## DESCRIPTION OF MAJOR CONTROLS AND COMPONENTS

*NOTE: DO NOT manually move drive motor arm. If you do, it will damage the drive gears in the motor.*

### A. Economizer Package

Electro-Mechanical System (See Picture K)

Drive motor - 24V, 42.3VA - W963B1009

Mixed Air Controller

Measures return or mixed air to insure air is not delivered at too cold a temperature. Field adjustable from 55°-80°.

Minimum Position Potentiometer

To provide an adjustable minimum position on the outside air damper to meet code and application requirements for fresh air. To be factory set at 0% open.

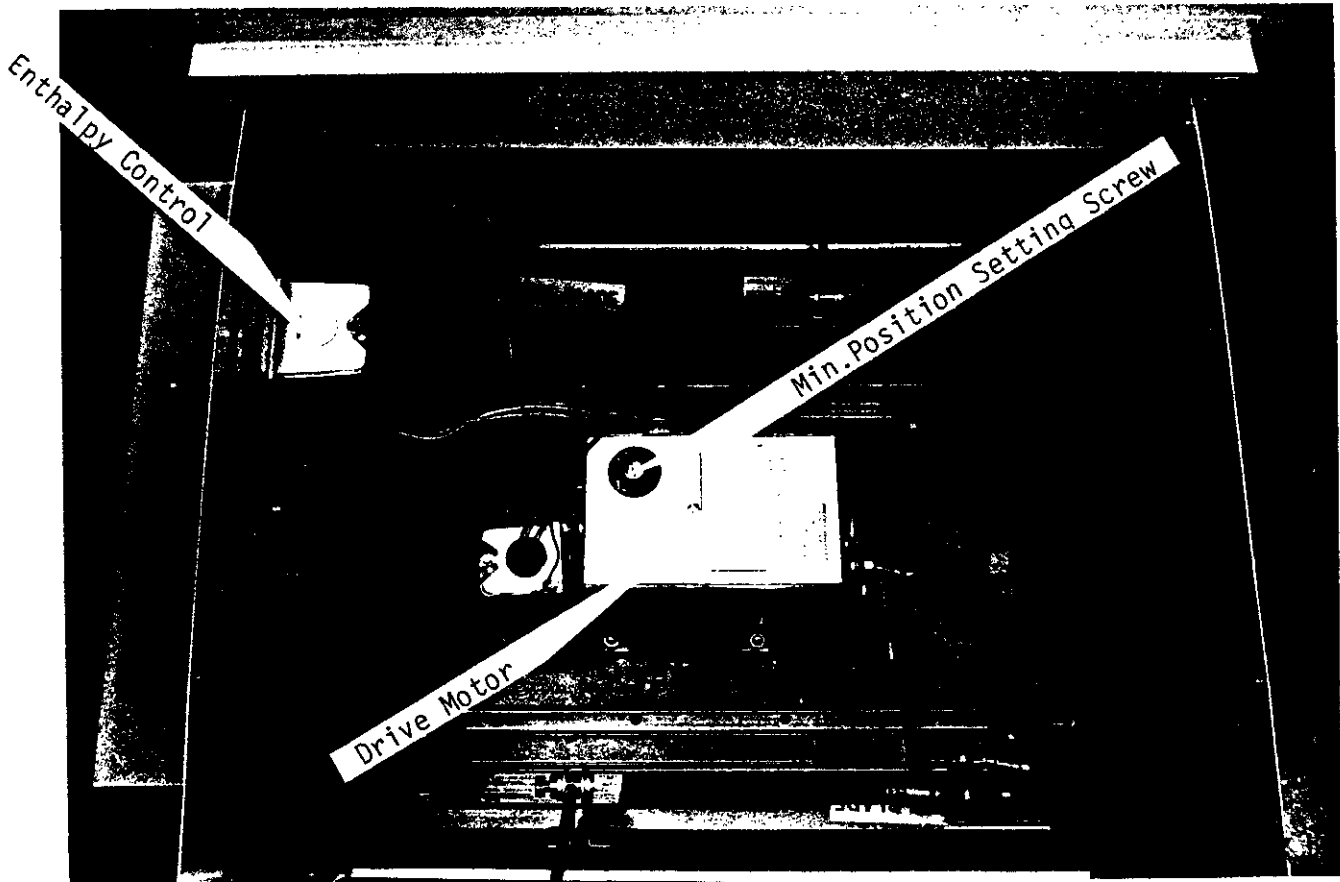

PICTURE K (Shown with top of Economizer off)

### B. Enthalpy Control (H205A1012B) (See Picture K)

Measures outdoor air temperature and humidity and interfaces with the Mixed Air Sensor to make the decision if outside air is sufficiently below the return air temperature to have the outside air provide "free-cooling."

### C. Other components used in the installation of economizer.

PACKAGED AIR CONDITIONERS	PACKAGED HEAT PUMPS
Thermostat - T874D1009 (2-stage cooling, 2-stage heating)	Thermostat - T8300B1027 (2-stage cooling, 2-stage heating)
Subbase - Q674B1000	Subbase - Q6300B1000
Dampers & Linkage (PD-3A or PD-5A)	Dampers & Linkage (PD-3A or PD-5A)
Transformer - 55VA (8407-015)	Transformer - 55VA (8407-015)
Relay - 8201-015	Relay - 8201-015

## BASIC INSTALLATION

1. Unpack the basic economizer assembly which includes the pre-assembled economizer. A separate box containing a 55VA transformer, mounting angles or gussets, a left-hand crank arm and necessary hardware is located in the economizer.
2. Assemble the return air damper to the economizer with four bolts at the end of the damper assembly to the angle at the bottom of the economizer (Picture A). Insure the end of the damper with the drive blade is towards the economizer. Also connect two sheet metal angle gussets with bolts and pointed screws provided (Picture B). Remove the right-hand crank arm from the return air damper which was packed separately and re-install in the same location the left-hand crank arm which was shipped with the economizer. Bolt through hole closest to arm (Picture C).



PICTURE A

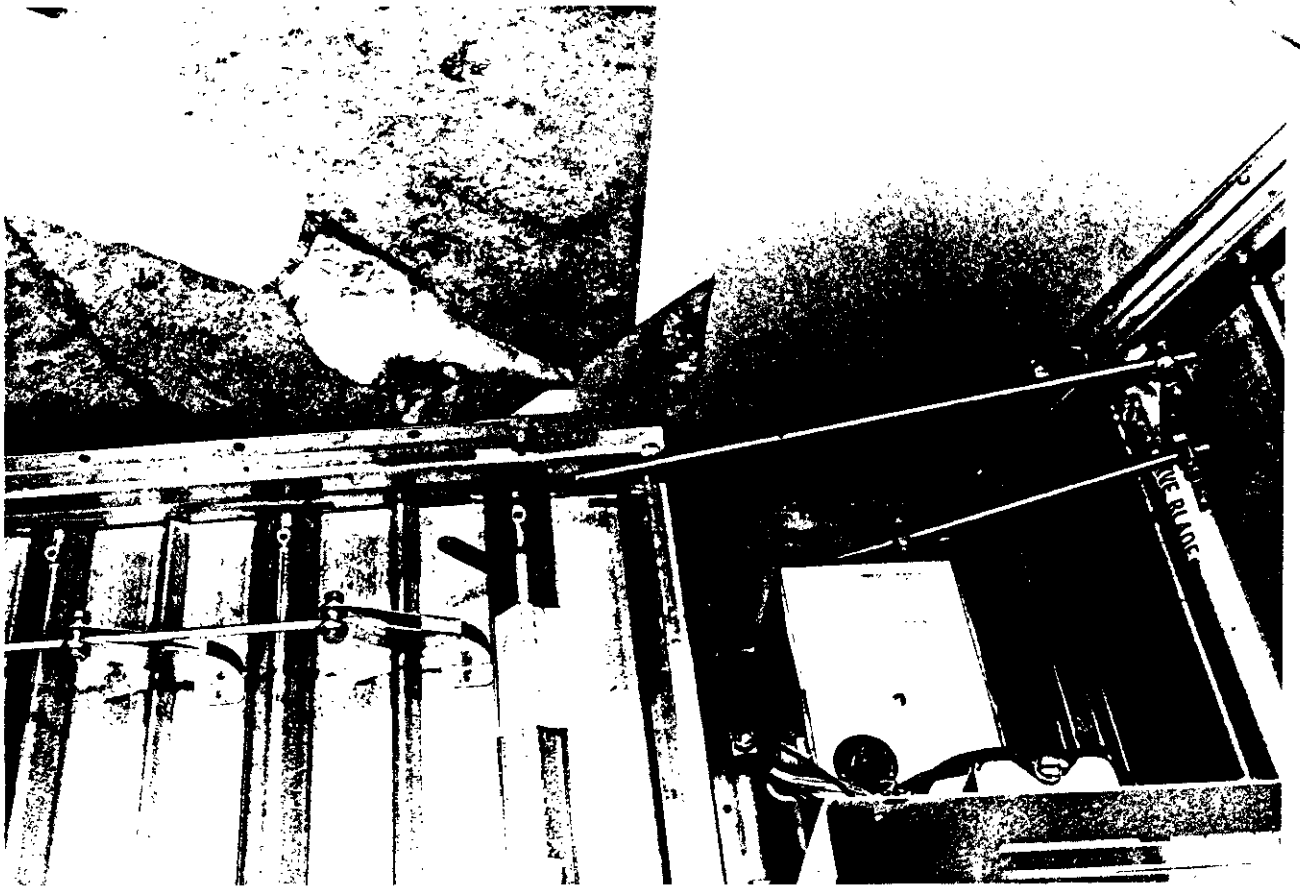

PICTURE B

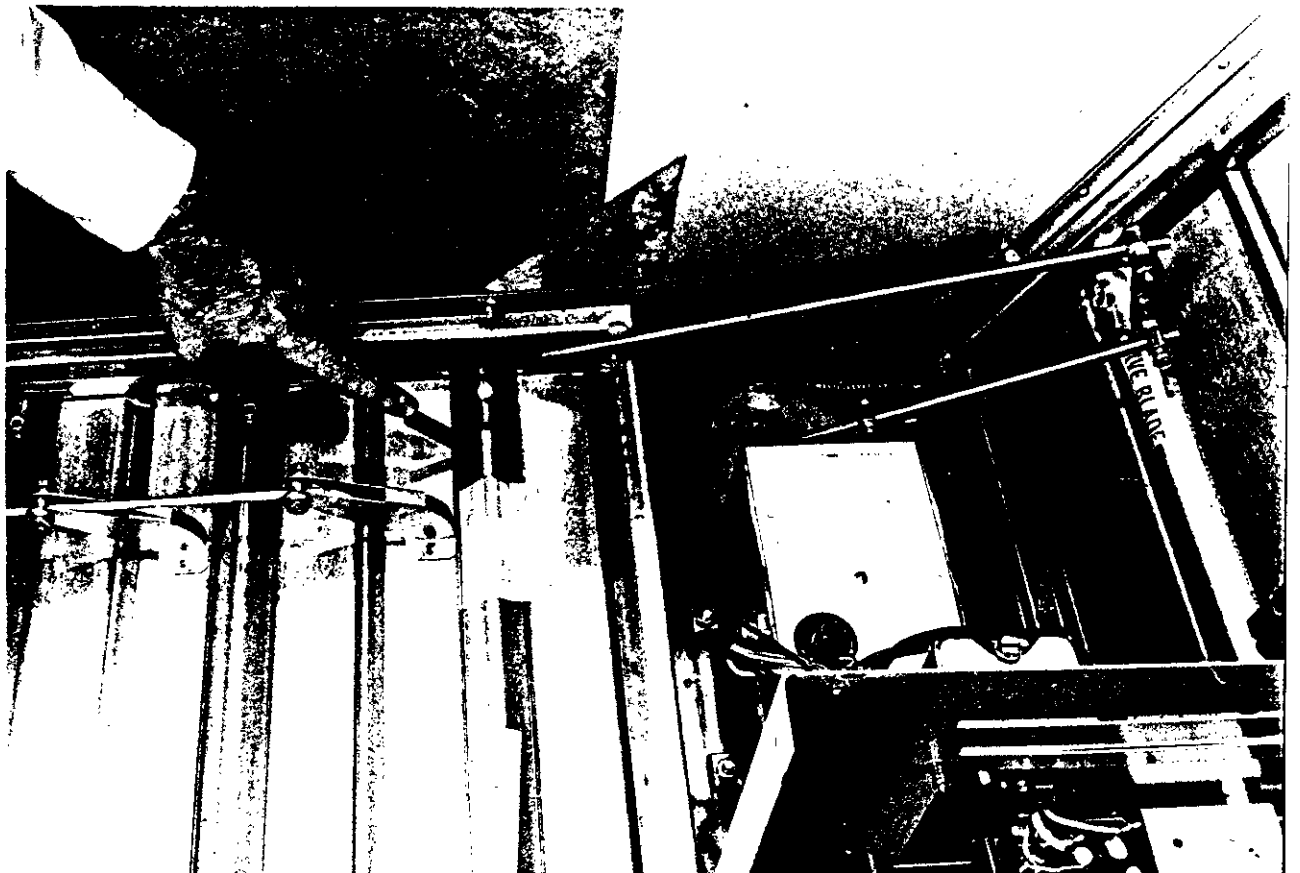

PICTURE C

3. Remove the economizer access cover from the side of the roof hood. RHE36 left side, RHE60 right side.
4. Remove the cover over the enthalpy control from the left side of the economizer package.

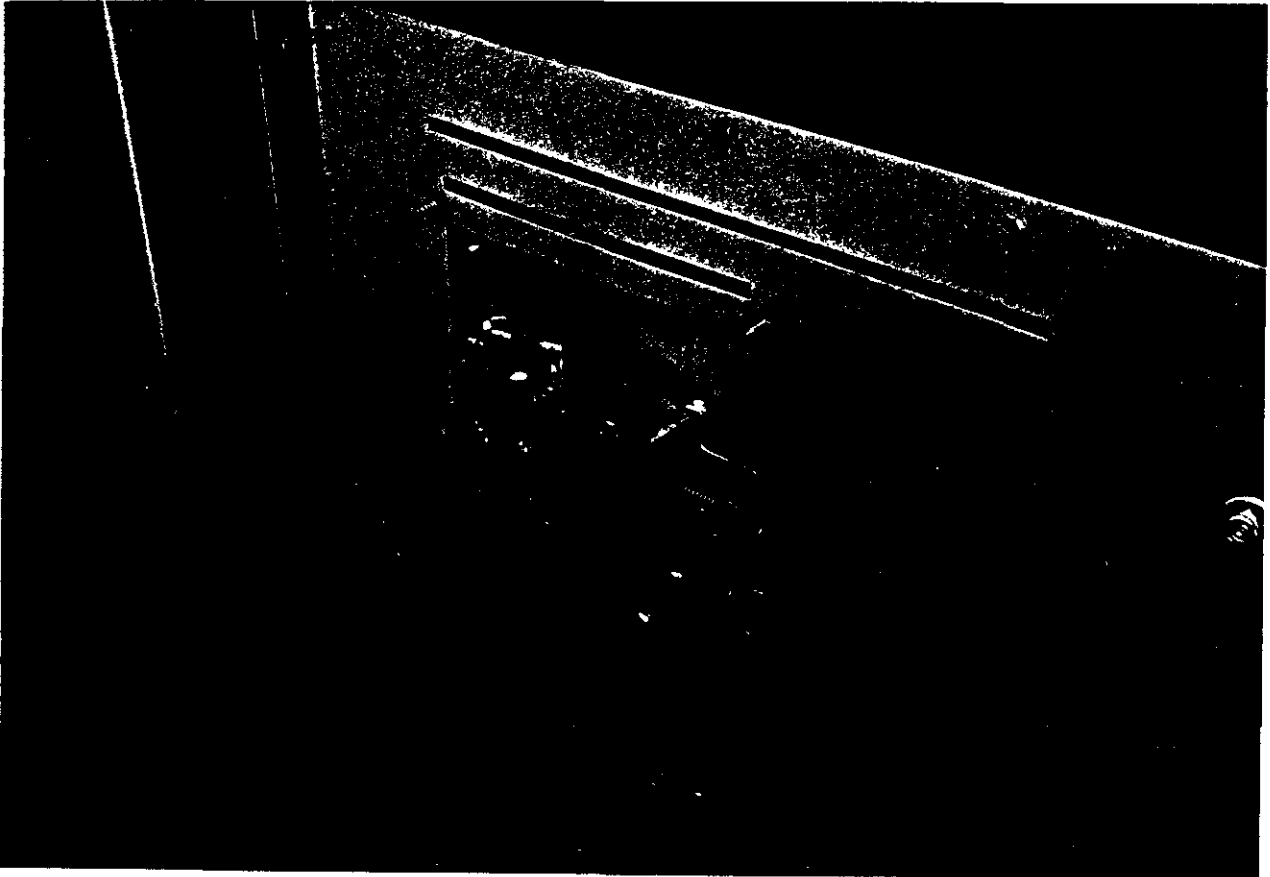

PICTURE D

5. With the dampers in the closed position, slide the economizer assembly (refer to Picture E) into the opening on the side of the roof hood on the two rails. Make sure that the damper assembly is square and flat on the slides or runners so the damper blades remain free. Secure the economizer to the roof hood with three screws on each side and the bottom flange. DO NOT attach the top flange of the economizer at this point. Reinstall the enthalpy cover.
6. Remove the top and filter from the economizer package.

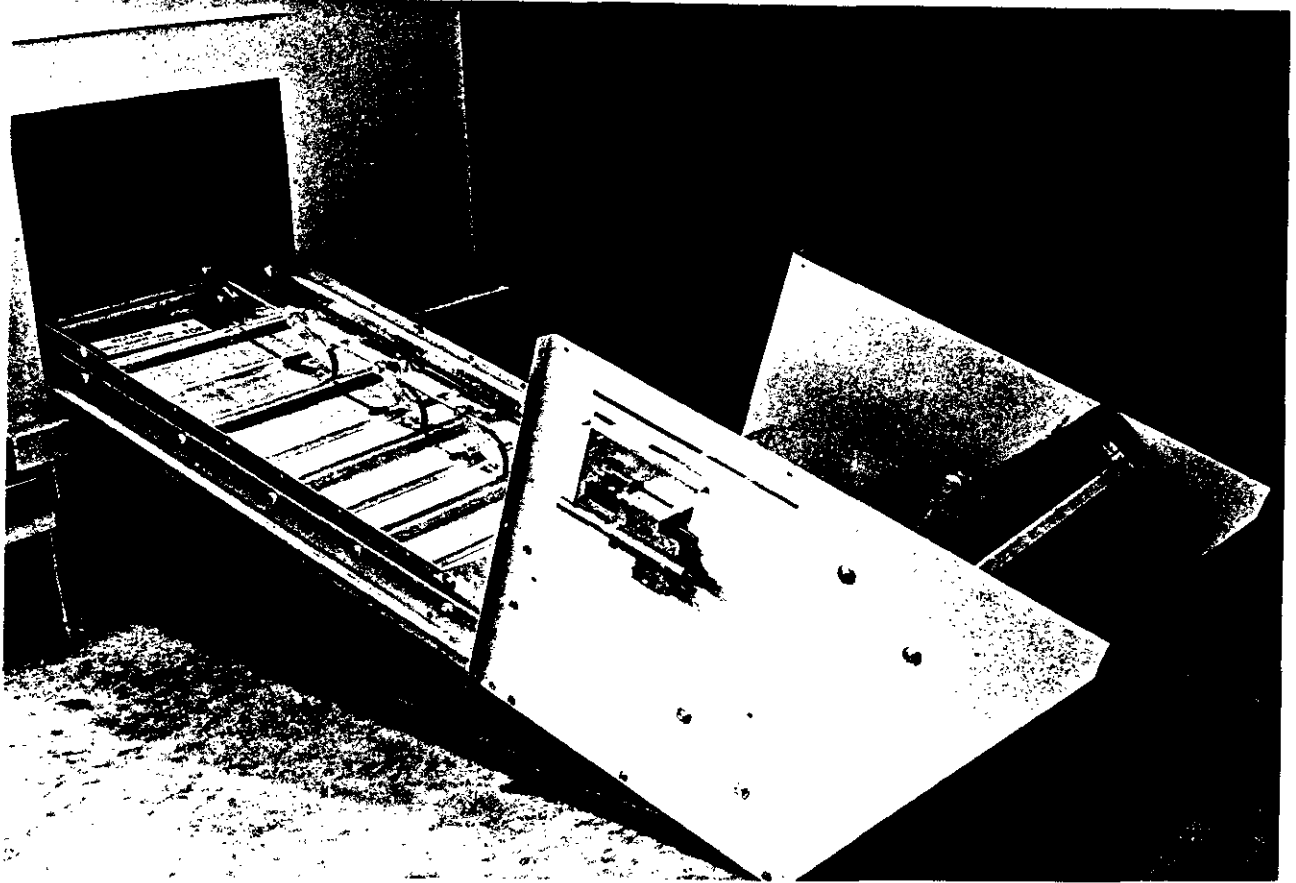

PICTURE E

7. Remove the plastic shipping ties from the economizer control sensor capillary and from the 18 inch damper rod. Note that the damper rod is 18 inches long which is the length required for the PD-5A. This must be shortened to 15 inches for use with the PD-3A.
8. Connect the 18 inch (or 15 inch) rod from the outside damper linkage to the crank arm on the return air damper using swivel nut included in parts package. Adjustment will be required at both ends. Adjust with outside air damper in the closed position and the return air damper in a full open position. (See Pictures F and G).
9. Route the mixed air sensor bulb to the plastic tie located under the bottom horizontal partition between the return air and supply air opening of the roof hood and secure in place. Take care in routing the capillary to insure that it will not be kinked or does not interfere with linkage or damper operation. The bulb on the capillary tube should be secured in the tie to prevent any vibration or movement during operation.





PICTURE F



PICTURE G

10. Electrical (Refer to Wiring Diagram)

- A. Install (drill holes and use screws provided) 55VA transformer 8407-015 packed with the economizer in the control panel of the P-series air conditioner or PH-series heat pump. Connect the two 230V leads (black and orange) to 230V supply connections (terminal block).

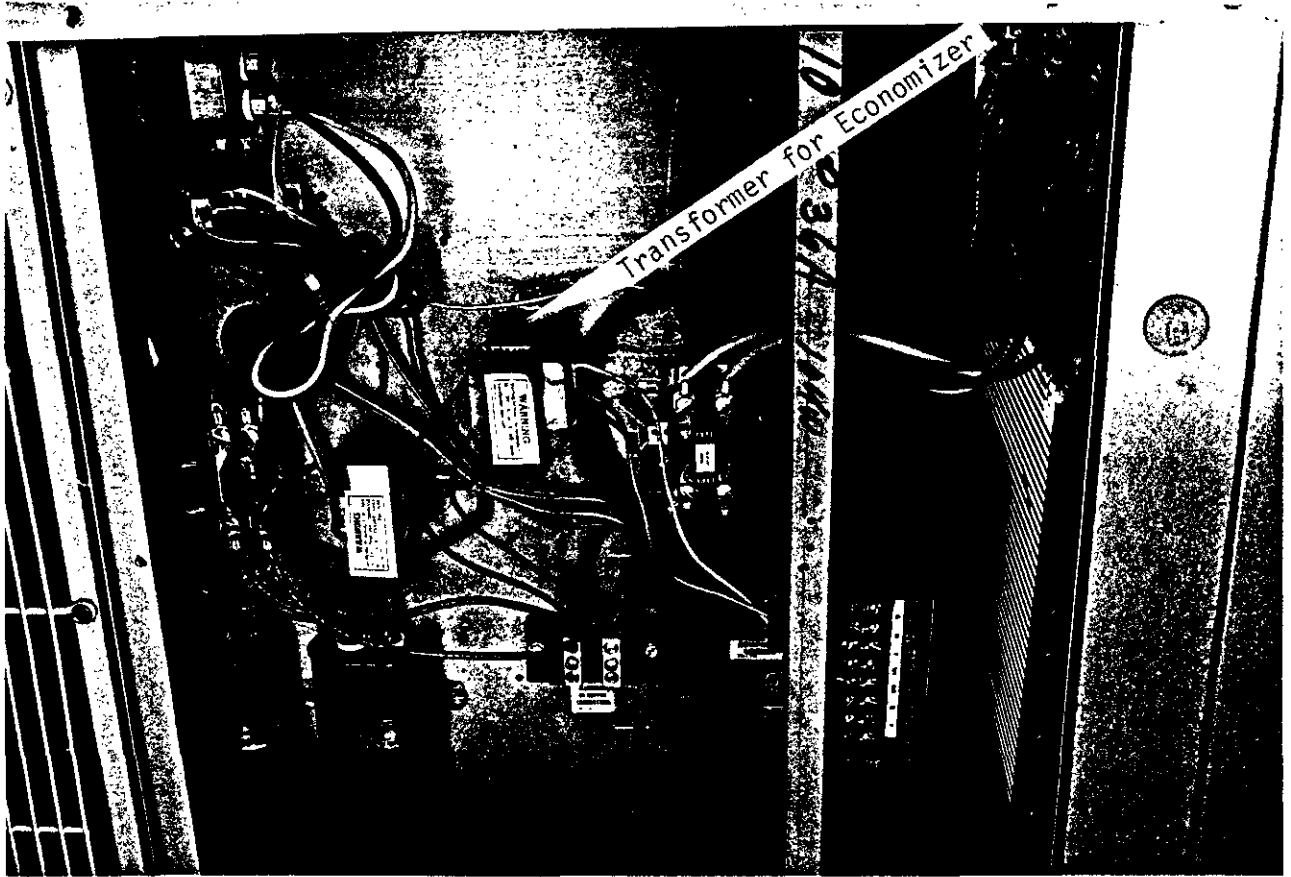

PICTURE H

(Typical transformer location for p36A. In other models, A/C and H/P units, locate the transformer in available space in control box.)

- B. 24V Connections - use the five wire thermostat cable supplied and connect two leads to the 55VA transformer 24V and three to the 24V terminal block per the wiring diagram. Route the 24V thermostat cable through the grommet in the bottom of the economizer and into the air conditioning control panel through the low voltage wire entrance hole provided in the unit.
- C. Wire the thermostat and subbase as shown on the diagram.

## 11. Field Adjustment

- A. Enthalpy Control - adjust control knob to position A, B, C or D. Set at maximum combination of temperature and humidity considered acceptable for the installation per chart I and II. (Typical would be halfway between A and B, 70°DB @ 55% R.H.).

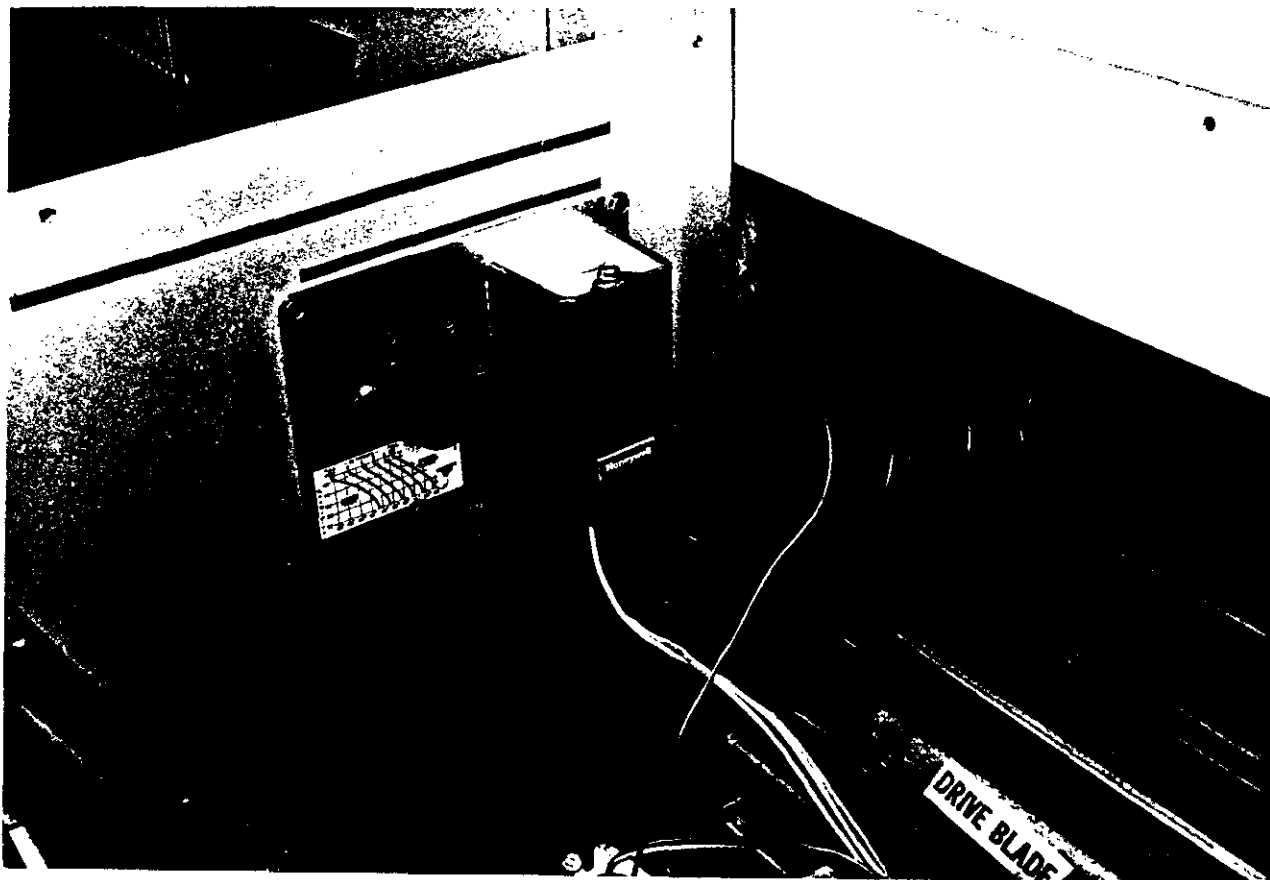

PICTURE I

# CHART I

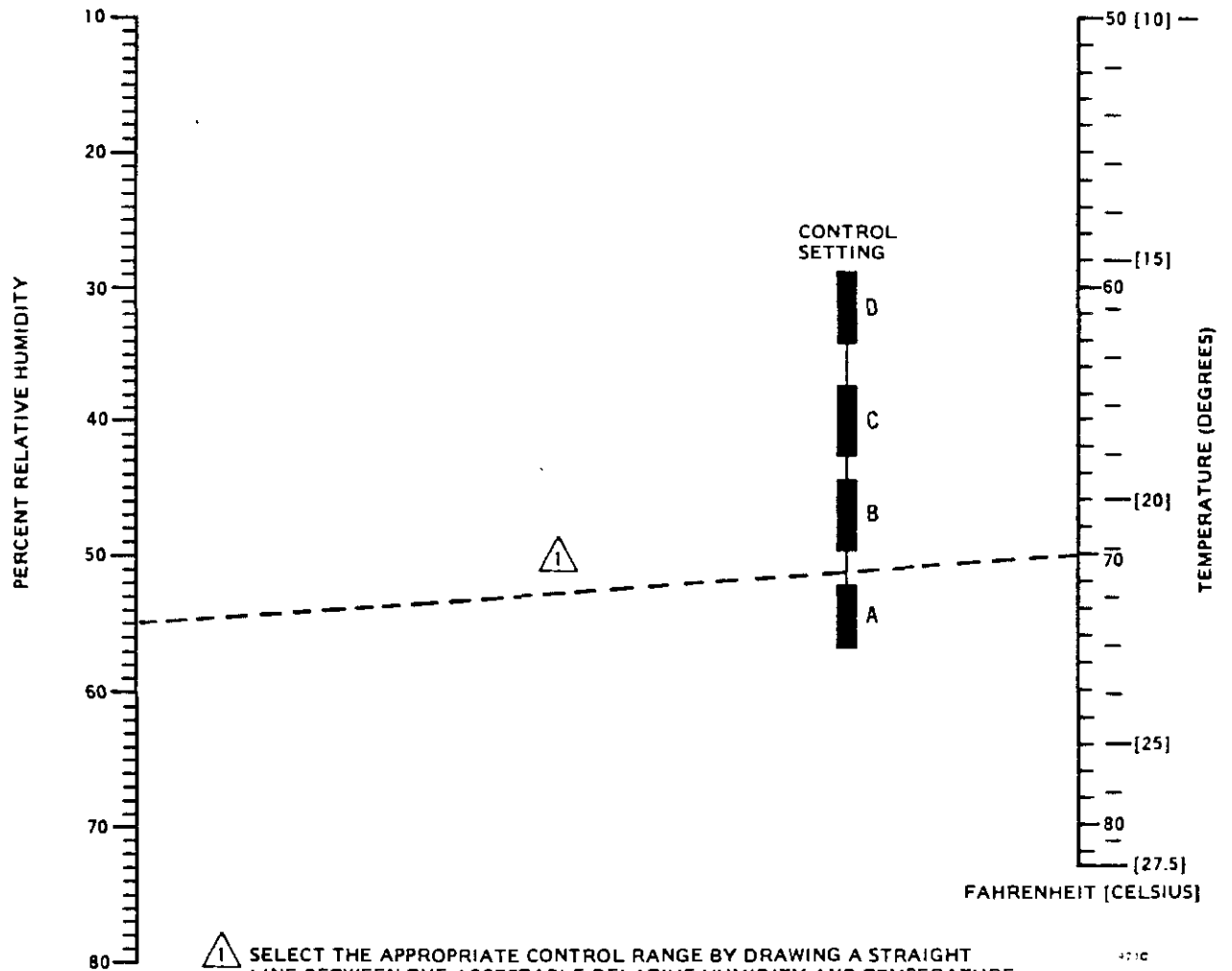

 SELECT THE APPROPRIATE CONTROL RANGE BY DRAWING A STRAIGHT LINE BETWEEN THE ACCEPTABLE RELATIVE HUMIDITY AND TEMPERATURE FOR INSTALLATION. ADJUST H205A DIAL TO CONTROL SETTING INDICATED.

# CHART II

Symbol	Meaning
A	Supply Air
B	Room Air
C	Return Air
D	Outdoor Air

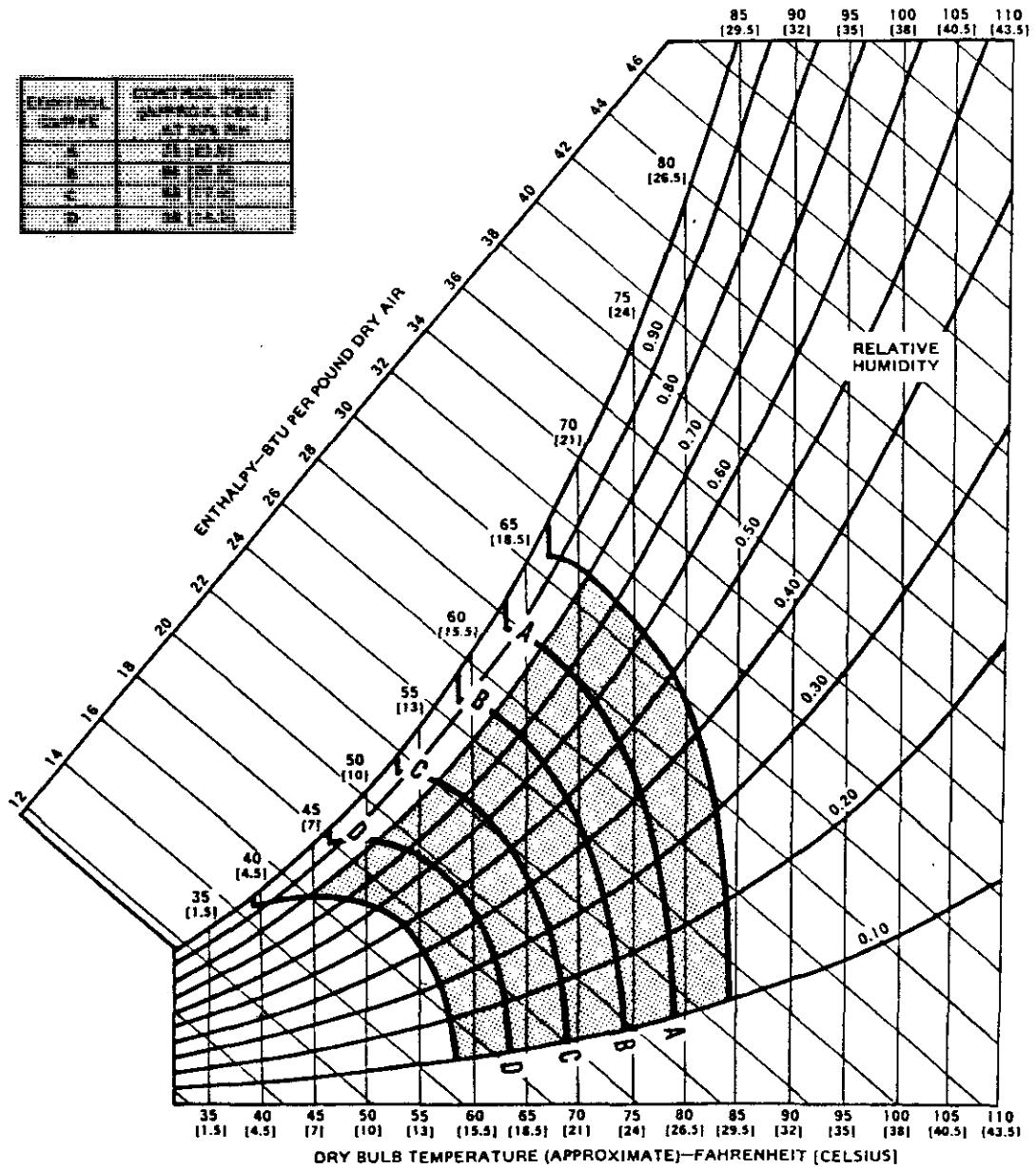

9708

PARTIAL PSYCHROMETRIC CHART WITH H205A PERFORMANCE CURVES SUPERIMPOSED. SHADED AREA REPRESENTS CONTROL RANGE. CURVES ILLUSTRATE RESET IN TEMPERATURE CONTROL POINT DUE TO CHANGES IN RELATIVE HUMIDITY.

- B. To adjust the minimum position potentiometer, set the minimum closing position of the outdoor air damper to meet local codes and/or application requirements for ventilation.

EXAMPLE:

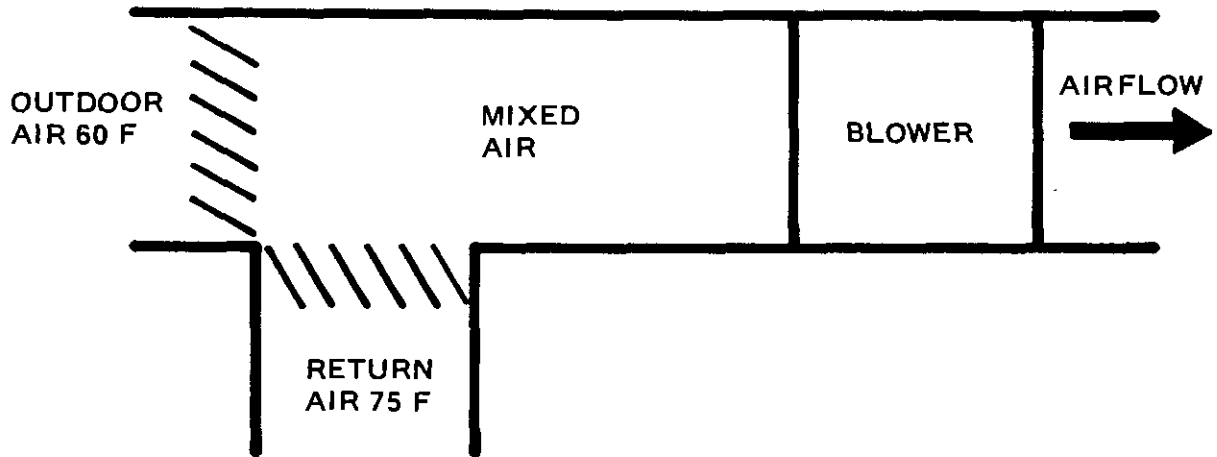

Assume: 10 percent minimum Outdoor Air is required by code—

1. Measure Return Air temperature (usually about 75°F).
2. Measure Outdoor Air temperature (60°F in this example).
3. Calculate the Mixed Air temperature which will result from the desired combination of OA (10 percent) and RA (90 percent)

$$\begin{array}{rcl} 10 \text{ percent} & = & .1 \times 60 \text{ degrees OA} & = & 6.0 \\ 90 \text{ percent} & = & .9 \times 75 \text{ degrees RA} & = & \underline{67.5} \\ & & \text{MA Temp.} & & 73.5 \text{ F} \end{array}$$

4. Make sure the Mixed Air controller is out of the circuit. Turn Mixed Air controller set point to highest setting.
5. Adjust minimum position potentiometer (by removing cap and turning slotted adjustment screw with screwdriver) until proper Mixed Air temperature, as calculated above, is reached. Care should be taken to insure thermometer is sensing air that is well mixed.
6. Mark correct setting on dial of minimum position potentiometer. Replace cap.
7. Return mixed air control to its proper setting (55-60°F).
12. Reinstall economizer filter and economizer cover. Now attach the top flange of the economizer to roof hood.

## SETTING AND ADJUSTMENT—— MIXED AIR CONTROLLER

The mixed air controller is set to maintain a mixed air temperature which provides satisfactory cooling and maximum system economy. Insert screwdriver through the hole in the case and turn inner dial to the desired setting. Suggested settings for different areas of the country are listed in Table 1.

TABLE 1—— RECOMMENDED MIXED AIR CONTROLLER  
SETTINGS FOR MAXIMUM ECONOMY

REGION	MIXED AIR
Southeast	60°F
South-Central	60°F
Southwest	55°F
West	55°F
North-Central	55°F
Northeast	55°F

## OPERATION——

The purpose of the economizer is to use outside air for cooling whenever possible to minimize compressor operating time.

When the space thermostat calls for cooling, the outside air damper will move to the full open position if outdoor air enthalpy is below the enthalpy control set point and mixed air temperature is above the mixed air limit set point. When the mixed air temperature falls below the limit set point, the limit controller opens.

Or, when the outside air enthalpy rises above the controller set point, the outside air damper closes to the minimum position. All cooling must then be provided by the mechanical cooling equipment.

The economizer is energized by the space thermostat. The economizer will operate only on a call for cooling and is held at minimum position during heating. This enables the economizer to function during cooling and provides maximum fuel economy during the heating cycle.

## SEQUENCE OF OPERATION

Condition 1 - Outside air is warmer than inside. Y1 closes on call for 1st stage cooling which is economizer cycle. Enthalpy control makes decision to keep dampers in normal position and blower comes on. Indoor temperature continues to rise until Y2 closes, turning compressor on. When Y2 is satisfied, compressor shuts off and blower continues to run until 1st stage is satisfied.

Condition 2 - Outside cooler than inside but due to internal load conditions, cooling is still required.

Y1 closes, blower turns on and dampers move to economizer mode position (outside air open-return air closed). Now in "free cooling" mode. On indoor temperature fall, Y1 opens - blower shuts off and dampers return to closed normal position.

If indoor temperature continues to rise and economizer mode cannot satisfy the cooling requirements, Y2 closes on wall stat. Compressor comes on and dampers return to normal position.

Condition 3 - Outside temperature is below the setting of the mixed air controller (to be factory set at 55°, field adjustable if desired) and cooling is still required due to high internal load.

Y1 closes on indoor temperature rise, blower turns on, outside air dampers remain closed, return air dampers remain open. As indoor temperature continues to rise, Y2 closes starting compressor.

## RELIEF DAMPER

Many buildings have enough natural relief to avoid severe problems with building and over-pressurization. In some installations, where large quantities of outdoor air is brought into a tightly constructed building, exhaust provisions may be required to prevent over-pressurization. This can be accomplished by (a) "natural" relief, (b) barometric relief dampers or (c) exhaust dampers. The need must be determined and if required, the proper selection must be made for the application by the HVAC system designer.

## CHECKOUT——

When installation is complete, check the entire system for proper operation. The checkout procedure is intended to ensure:

1. The economizer controls operate properly.
2. The motor operates properly.
3. The dampers perform as intended without binding.

Set thermostat well below room temperature and set enthalpy controller at maximum. Outdoor air damper should open and return air damper should close.

When the setting of thermostat or enthalpy controller is turned to the other end of its range, the outdoor air damper should close to minimum position and the return air damper should open.

Before leaving the installation, be sure to return all controllers to their recommended settings.



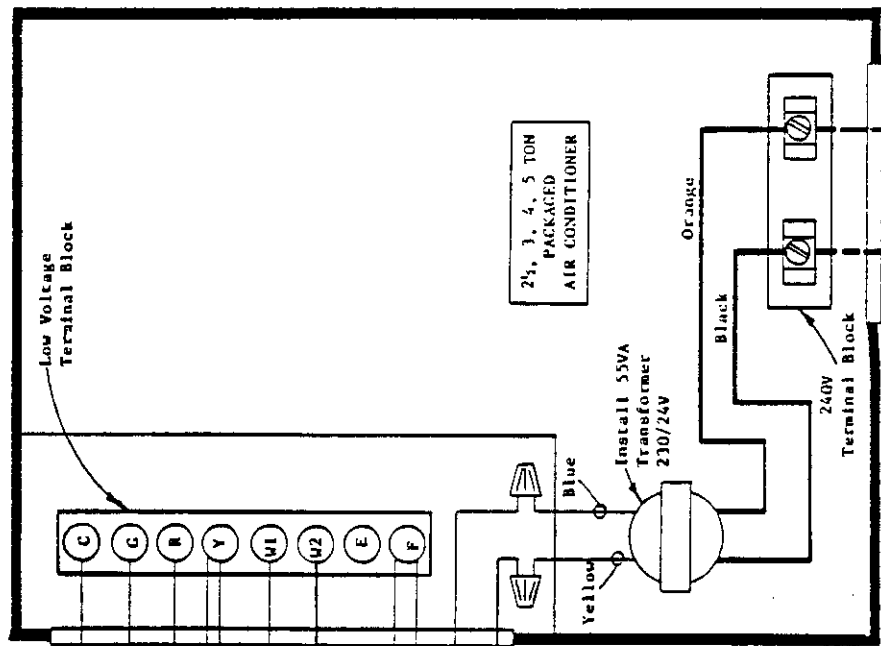
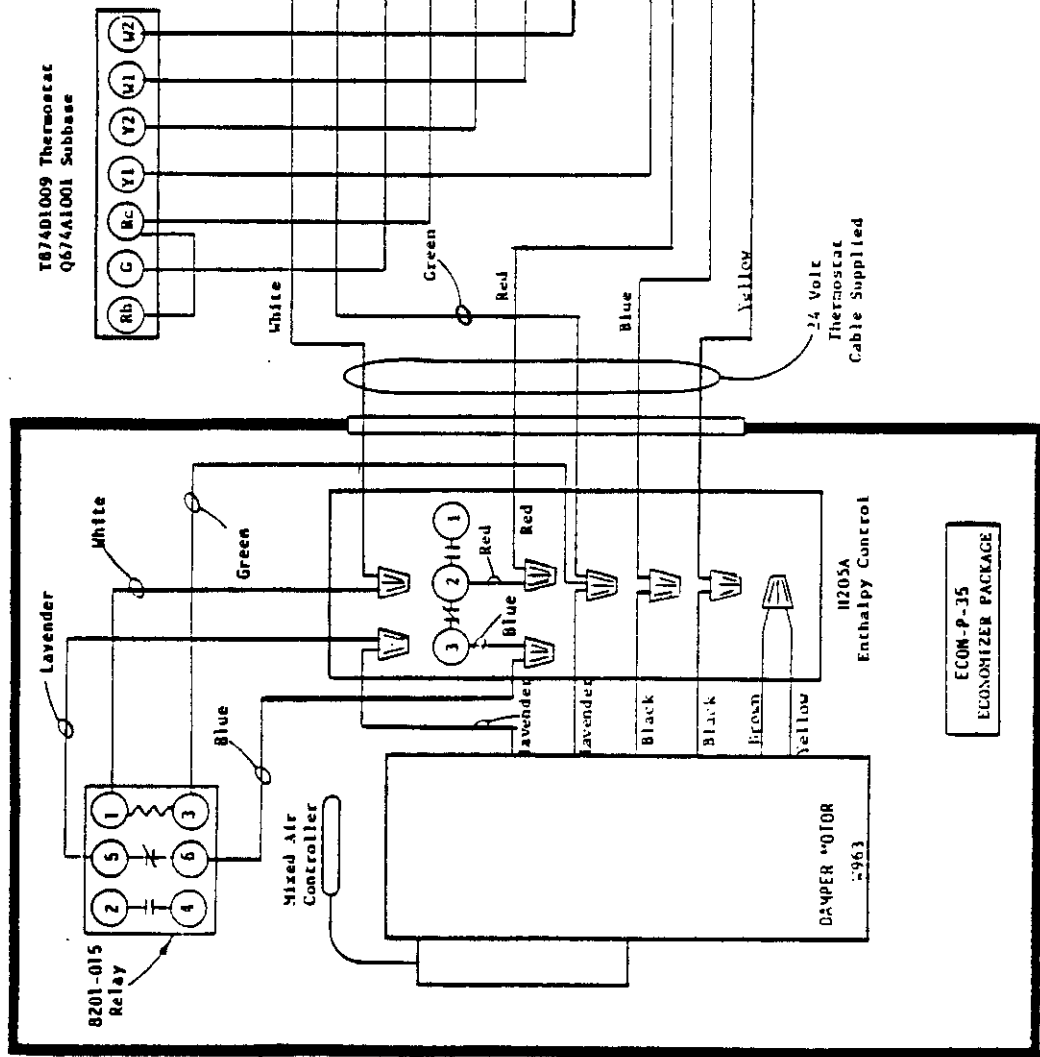

T874D1009 Thermostat  
Q674A1001 Subbase

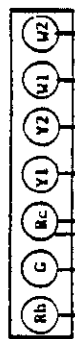

High Voltage Wiring (240V) \_\_\_\_\_  
Low Voltage Wiring (24V) \_\_\_\_\_

**AIR CONDITIONER CONNECTION DIAGRAM**

230-20R-1-60

4056-110A

Line Voltage  
Supply to Unit

T 8300B 1027 (8403 023)  
Q 6300B 1000 (8404 015)

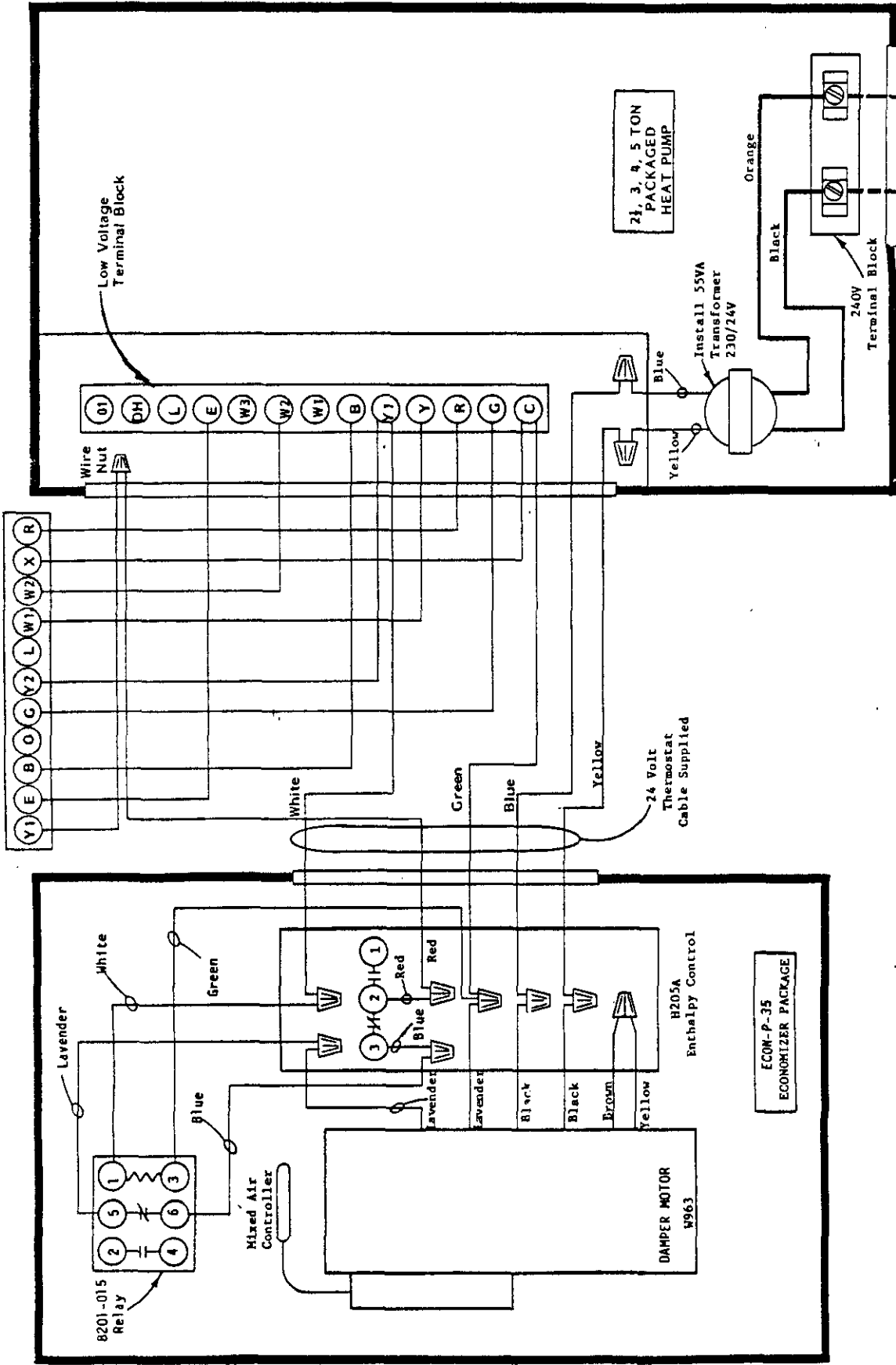

High Voltage Wiring (240V) ———  
Low Voltage Wiring (24V) ———

HEAT PUMP CONNECTION DIAGRAM