

MANUAL 2100-099D

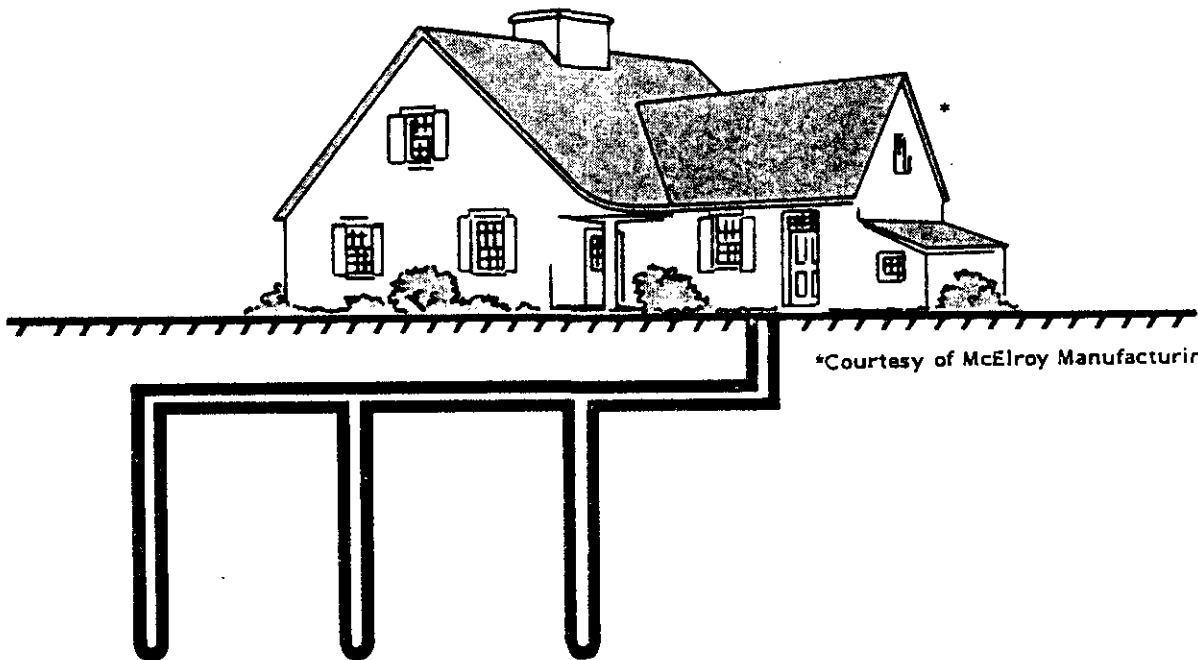

EARTH COUPLED LOOP SYSTEM DESIGN MANUAL



*Courtesy of McElroy Manufacturing.

BARD MANUFACTURING CO. • BRYAN, OHIO 43506
DEPENDABLE QUALITY EQUIPMENT... SINCE 1914

IMPORTANT

The following Bard Water Source Heat Pumps will not work on earth loop systems.

WPV 30 or WPVD 30
WPV 36 or WPVD 36
WPV 53 or WPVD 53
WPV 62 or WPVD 62
WQS 30 or WQSD 30
WQS 36 or WQSD 36
WQS 50 or WQSD 50

For EARTH LOOP SYSTEMS use one of the following:

WPV 30A or WPVD 30A
WPV 36A or WPVD 36A
WPV 53A or WPVD 53A
WPV 62A or WPVD 62A
HWP 30 or HWP 30
HWP 36 or HWP 36

The design of an earth coupled system is divided up into the following steps.

- I. Determine the structure design heating load in Btuh loss and design cooling load in Btuh gain. It is very important that an accurate load calculation of the structure be done, therefore, it is recommended that "Manual J" from ACCA or other national accepted methods be used.
- II. Select a water source heat pump. When selecting a water source heat pump for use on an earth coupled system, it may have to operate at entering water temperatures between 30°F to 100°F, therefore it is very important that the minimum and maximum entering water temperatures of the selected water source be within that range. Several models on the market today have a much smaller operating range such as 45° to 85° or 60° to 85° entering water temperature. Some of those will not provide satisfactory operation on an earth coupled installation.

The heating or cooling capacity of the water source heat pump should be determined from the manufacturer's specifications for the local ground water temperatures. The water source heat pump should be sized as follows:

Heat Pumps Sized For Cooling. The sensible output capacity of cooling equipment, should not be less than calculated total sensible load nor should it exceed the calculated sensible load by more than 25 percent. The corresponding latent capacity should not be less than the calculated total latent load. The equipment sensible and latent capacities should be determined from the manufacturers cataloged performance data. Catalog performance should be verified at the local ground water temperature and indoor design conditions expected on a design day.¹

Heat pumps which are sized for heating only should not be less than 75 percent nor more than 115 percent of the calculated total heating load. (Auxiliary heat should be sized to make up for any deficiency in output when the heat pump unit is undersized.) Emergency heat may be required in some locations.²

Heat pumps which provide heating and cooling shall be sized to the cooling requirements specified above. In this case the thermal balance point will be limited by the design cooling requirement but, if a lower thermal balance point is desired, heat pumps may be oversized for sensible cooling by up to 25 percent. Auxiliary heat should be sized to make up for the difference between the design heating load and the heat pump output on a design day. Emergency heat may also be required in some locations.³

III. Selection of type earth coil and materials to be used.

EARTH COUPLED SYSTEMS--Earth coupling is a method by which water used by the heat pump is circulated through pipes buried in the ground. Heat is transferred to and from the soil through the walls of the pipe. Earth coupled systems are used in areas where insufficient ground water is available, or where it is impractical to drill a well. The piping may be buried in either a vertical or a horizontal configuration.

When designing an earth coupled system, particular attention must be paid to balancing the system between the heat pump unit and the earth coupled loop. In a balanced system, the earth coupled loop will remove all of the heat energy transferred to the water by the heat pump (cooling cycle), and will provide all of the heat energy to the water that the heat pump unit is capable of absorbing (heating cycle). The net result of a perfectly balanced system is that the change in water temperature through the heat pump is offset by an equal and opposite change in temperature through the earth coupled loop. For instance, if the heat pump unit in the cooling cycle causes the water temperature to rise 15°F, then the loop must cause a corresponding drop of 15°F.

A word of caution is required here. Although the earth coupled loop is designed for a balanced rise and fall in water temperature, suggesting that the net average loop water temperature remains constant, because the ground temperature may vary $\pm 15^\circ\text{F}$ from season to season, the loop water temperature may vary $\pm 20^\circ\text{F}$ from the balance point temperature. This is because the ground is able to overcool the loop water in winter, and may undercool in summer. Because of this, the temperature of the water entering the water source heat pump unit may drop below 30°F in winter or rise above 100°F in summer. This range in entering water temperature is extremely important because water source heat pumps are designed to operate within specific operating temperature ranges (see manufacturer's specifications for water source heat pump operating ranges). The temperature ranges are established to protect both the heat pump unit and the water loop piping. Furthermore, these temperature ranges are based on water only passing through the system. The low temperature limit of 40°F in a water source heat pump unit is established to protect the loop water from freezing. Again, this low limit presumes that water only flows through the system. If, however, water is mixed with a non-toxic antifreeze solution, the entering water temperature can be allowed to fall to 30°F.

HEAT PUMP:

Use only a water source heat pump that can be operated on loop temperatures well below 40°F down to 25°F. Information on when to use an antifreeze solution in a ground coupled water source heat pump system is contained in the following discussions on vertical and horizontal configurations.

PIPE:

Use polybutylene (PB) or polyethylene (PE) pipe for horizontal coils, vertical U-bend wells and for service lines to the wells and lake exchangers. IPS PB pipe is used with insert fittings and clamps. CT5 PB pipe is fused together with appropriate fittings using a fusion tool. PE pipe is heat butt fused with appropriate fittings using a fusion tool.

CLEANLINESS:

During installation keep trash, soil and small animals out of the pipe. Leave the ends of the earth loop pipe taped until the pipe is ready to be connected to the service lines or the equipment room piping.

PRESSURE TESTING:

Plastic pipe assemblies should be pressure tested at twice the anticipated system operating pressure prior to backfilling. Normal static equipment room pressure is 50 psig.

BACKFILL:

Narrow trenches made with a chain trencher can be backfilled with the tailings provided no sharp rocks are present.

Wider backhoed trenches can be backfilled with the excavated material provided it is in loose granular form. If the material contains clumps of clay or rocks, the plastic pipe must be covered first with sand before filling in with clumps and rocks.

Drilled boreholes of 4-6 inches in diameter are common for vertical geothermal wells. Backfill may be any granular material not containing sharp rocks. This includes the drilling tailings, sand, pea gravel or bentonite mud.

LOCATION MARKERS:

It is desirable that the locations of important points such as well heads be marked for subsequent recovery. The placement of a steel rod just below the surface can identify these features or mark the outline of an entire serpentine earth coil.

^{1,2,3} "Manual J by Air Conditioning Contractors of America, 1981 Edition, p. 44.

AS-BUILT PLANS:

Earth coupling features should be drawn on a site plan as installed if possible, to aid in the location of key components. A simple way to locate key features is to make 2 measurements (sides of a triangle) from 2 corners of a building to the feature. Record these measurements in a table on the plans.

Reasons for using an earth coupled system.

1. Unlike a standard solar system the loop operates day or night, rain or shine all year, delivering heat to and from the heat pump.
2. It is cost effective in northern or southern climates.
3. Because the water circulates through a sealed closed-loop of high strength plastic pipe, it eliminates scaling, corrosion, water shortage, pollution, waste and disposal problems possible in some open well water systems.

VERTICAL. A vertical earth coupled system consists of one or more vertical boreholes through which water flows in plastic pipe. A distinct advantage of a vertical system over a horizontal system is that the vertical system requires less surface area (acreage). In areas where the ambient groundwater (average well water) temperature is less than 60°F, the use of an antifreeze solution, such as propylene glycol, to avoid freezing the loop is recommended. (Figures 1, 2 and 3).

Boreholes are drilled 5" to 6" in diameter for 1-1/2" diameter pipe. For 3/4" diameter pipe loop systems, the vertical loops are connected in parallel to a 1-1/2" diameter pipe header. A borehole of 3" to 4" in diameter is used for 3/4" diameter loops, this lowers drilling cost. The 3/4" diameter pipe also costs less per ton of heat pump capacity. The smaller pipe is easier to handle, yet there is no sacrifice in pressure rating. Also two loops in one hole reduces borehole length. Depth for these systems is usually between 80 and 180 feet.

The basic components of a vertical earth coupled system are detailed in Figure 1. Each borehole contains a double length of pipe with a U-bend fitting at the bottom. Multiple boreholes may be joined in series or in parallel. Sand or gravel packing is required around the piping to assure heat transfer. In addition, the bore around the pipes and immediately below the service (connecting) lines must be cemented closed to prevent surface water contamination of an aquifer in accordance with local health department regulations.

SERIES U-BEND

A series U-bend well earth coupling is one in which all the water flows through all of the pipe, progressively traveling down and then up each well bore. Series wells need not be of equal length.

PIPE:

1-1/2" CTS or IPS polybutylene or polyethylene pipe is commonly used in 5 to 6 inch bore holes. IPS PB pipe is used with insert fittings and clamps. Turn the clamps so that they face inward and will not be chaffed by the well bore. Tape the clamped section of the U-bend with duct tape to provide added protection to the clamps while the pipe is being installed into the well.

CTS PB pipe is heat fused together with fittings. PE pipe is heat fused together with butt joints.

STIFFENER:

Tape the last 10 to 15 feet of pipe above the U-bend together to a rigid piece of pipe or conduit. This will make installing the pipe into the well easier.

FILL AND PRESSURE TEST:

Fill with water and pressure test before lowering the U-bend into a well bore. When drilling with air, a bore can be completed that contains no water. If unfilled plastic pipe is lowered into the bore, it will be crushed as the hole slowly fills.

MULTIPLE WELLS:

Multiple 100' wells connected in series are the easiest to drill and install in most areas. It will be difficult to sink water filled plastic U-bends into mud filled holes over 150' deep without weights. Wells are generally spaced 10 feet apart in residential systems.

SERVICE LINES:

Follow the guidelines for the horizontal earth coil when installing the service lines to and from the U-bend well.

PARALLEL U-BEND

A parallel U-bend well earth coupling is one in which the water flows out through one header, is divided equally, and flows simultaneously down two or more U-bends. It then returns to the other header. Headers are reverse return plumbed so that equal length U-bends have equal flow rates. Lengths of individual parallel U-bends must be within 10% of each other to insure equal flow in each well.

PIPE:

1-1/2" CTS polybutylene or polyethylene pipe is used for the headers with 1" or 3/4" pipe used for the U-bends. 4" bore holes are sufficient for placement of 1" U-bends.

Follow "Series U-bend Well" instructions on:

STIFFENER
FILL & PRESSURE TEST
MULTIPLE WELLS
SERVICE LINES

VERTICAL (SERIES) SYSTEM

PIPE: High strength polyethylene,
fusion joined

or

polybutylene, joined with type
300 stainless steel bands and
stainless screws or heat fusion
fittings

FLOW PATH: SERIES

PIPE SIZES: 3/4, 1, 1-1/4, 1-1/2 & 2 INCH

BORE LENGTH: 100 to 175 FEET/TON

PIPE LENGTH: 200 to 350 FEET/TON

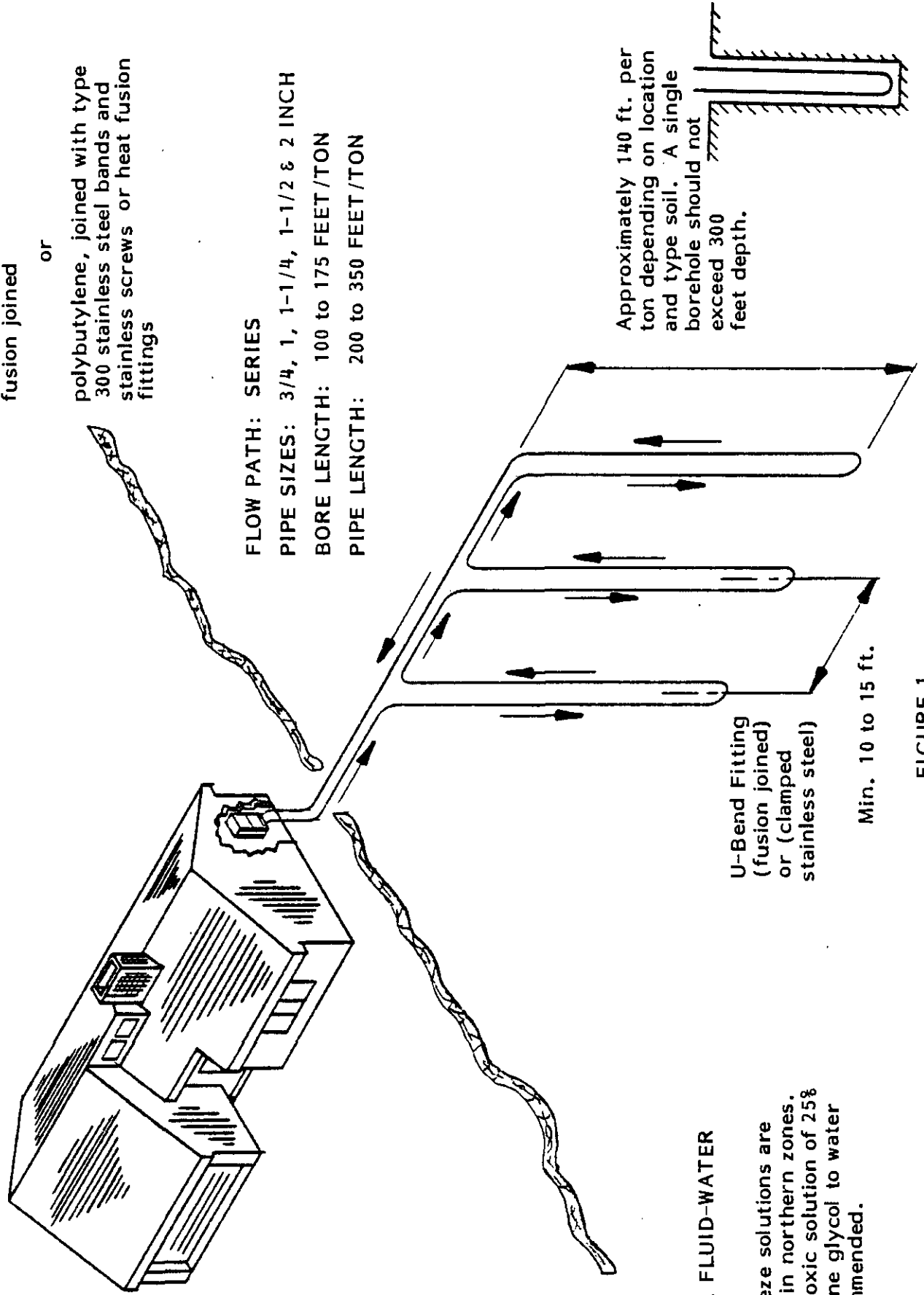

TRANSFER FLUID-WATER

NOTE:

Antifreeze solutions are
needed in northern zones.
A non-toxic solution of 25%
propylene glycol to water
is recommended.

Min. 10 to 15 ft.

Approximately 140 ft. per
ton depending on location
and type soil. A single
borehole should not
exceed 300
feet depth.

FIGURE 1.

VERTICAL (PARALLEL) SYSTEM

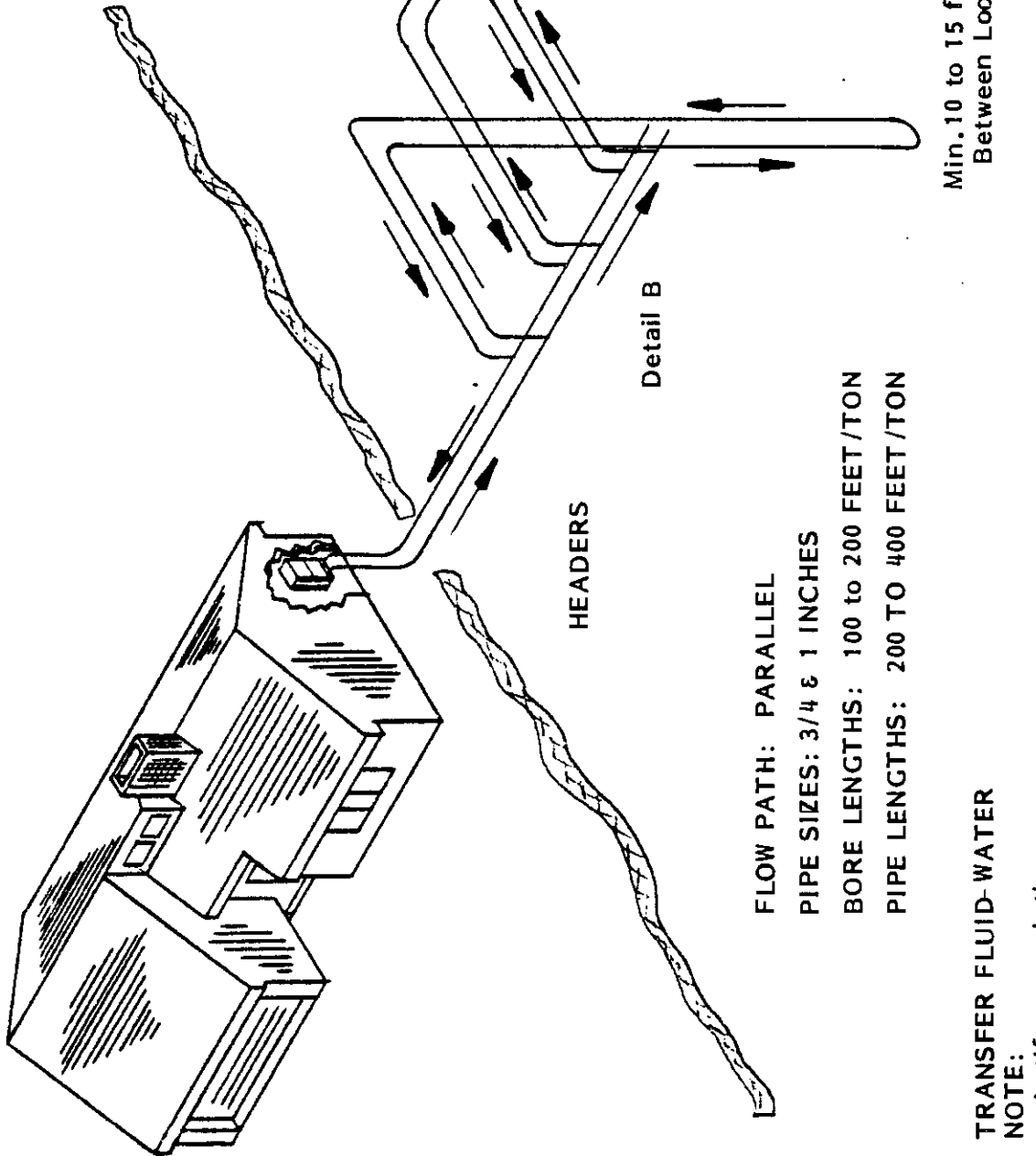

PIPE - Header, 1-1/2" O.D. Vertical,
 3/4" O.D. or 1" O.D.
 polyethylene high strength
 fusion joined or high strength
 polybutylene joined with Type 300
 stainless steel bands and screws
 or heat fusion fittings

FLOW PATH: PARALLEL
 PIPE SIZES: 3/4 & 1 INCHES
 BORE LENGTHS: 100 TO 200 FEET/TON
 PIPE LENGTHS: 200 TO 400 FEET/TON

TRANSFER FLUID-WATER
 NOTE:
 Antifreeze solutions are
 needed in northern zones.

Approximately
 170 ft. + per ton
 depending on
 location and type
 soil

Min. 10 to 15 ft.
 Between Loops

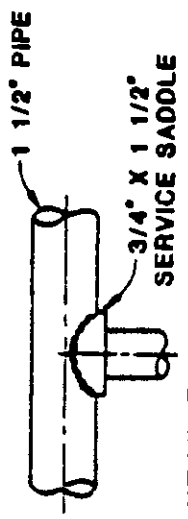

U-Bend Fitting
 (fusion joined)

DETAIL B

FIG 1:2

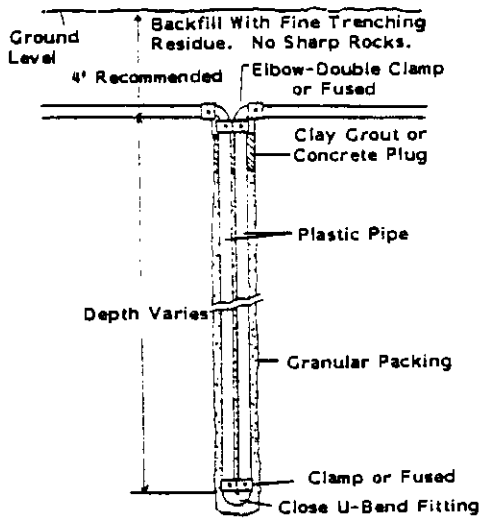
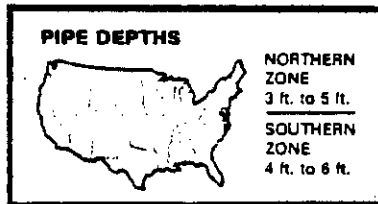

FIGURE 3. Vertical Earth Coupled Borehole & Piping

HORIZONTAL. A horizontal earth coupled system is similar to a vertical system in that water circulates through underground piping. However, the piping in this system is buried in a trench. (Figures 7, 8 and 9).



Pipe depths in the Northern Zone should be 3 to 5 feet. Excessive depth will reduce the ability of the sun to recharge the heat used in winter.

Pipe depths in the Southern Zone should be 4 to 6 feet, so that the high temperature of the soil in late summer time will not seriously affect system performance.

Antifreeze will be necessary in the Northern Zone to prevent freezing of the circulated water and to allow the system to gain capacity and efficiency, by using the large amount of heat released when the water contained in the soil is frozen.

Antifreeze solutions used is a non-toxic Propylene Glycol or Calcium Chloride.

The use of multiple pipes in a trench reduces total trench length substantially. If a double layer of pipe is laid in the trench (Figure 4), then the two layers should be set two feet apart to minimize thermal interference. Example: A 1-1/2" series horizontal system with pipes at 5 feet and 3 feet. After installing first pipe at 5 feet depth, partially backfill to 3 feet depth using a depth gauge stick before installing second pipe. With the return line running closest to the surface and the supply line running below it. This arrangement will maximize the overall system efficiency by providing warmer water in heating mode and colder water for cooling mode. Connect pipe ends to heat pump after the pipe temperature has stabilized, so that shrinkage will not pull pipe loose.

Two pipes in the same trench, one above the other, separated by two feet of earth require a trench 60 percent as long as a single pipe. The total length of pipe would be 120 percent as long as a single pipe due to the heat transfer effect between the pipes.

In addition, when laying a double layer of pipe, be careful to avoid kinks when making the return bend (see Figure 5). Backfill the trench by hand when changing direction. If it is necessary to join two pipes together in the trench, use the fusion technique or IPS304 stainless steel or brass fittings for greater strength and durability, then mark fitting locations for future reference by inserting a steel rod just below grade (see Figure 6). The steel rod enables the use of a metal detector to find joints in pipe.

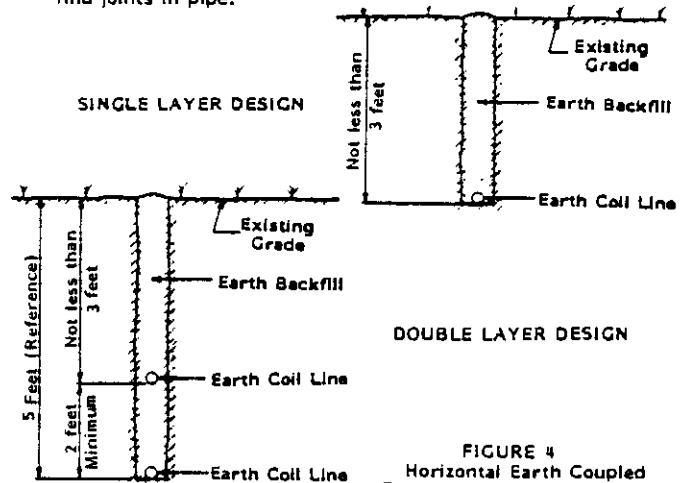
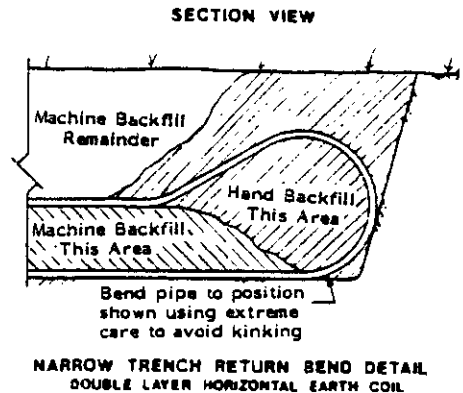

FIGURE 4 Horizontal Earth Coupled Pipe Separation in the Trench

Trenches can be located closer together if pipe in the previous trench can be tested and covered before the next trench is started. This also makes backfilling easier. Four to five feet spacing is good.

In those areas with dry climates and heavy clay soil, heat dissipated into the soil may reduce the thermal conductivity of the soil significantly. In such cases, the designer may specify additional feet of pipe per ton of capacity. A few inches of sand may also be put in with the pipe, or a drip irrigation pipe buried with the top pipe to add occasional small amounts of water.

FIGURE 5.



When making the return bend be careful not to kink the pipe. 2" pipe requires a 4" diameter band.

FIGURE 6.

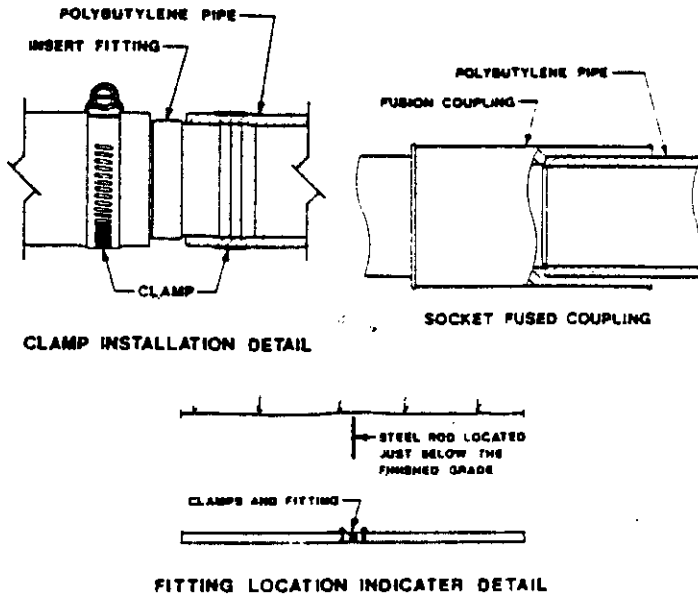

Series horizontal earth couplings are ones in which all the water flows through all of the pipe. These may be made of 1", 1½" and 2" pipe either insert coupled or fused.

NARROW TRENCHES:

Narrow trenches are installed by trenching machines. The trenches are usually 6" wide. Generally speaking, the trencher will require about 5' between trenches. This is sufficient spacing for horizontal earth coils.

The pipe can be coiled into an adjoining trench. Since the trencher spaces the trenches about 5' apart, looping the coil from one trench to another will give a large enough diameter return. The end trench should be backhoed to give enough room for the large diameter band.

If the pipe is brought back in the same trench, bend the pipe over carefully to avoid kinking the pipe and hand backfill the area around the return bend (Figure 5).

To reduce the bend radius, elbows may be used. However, keeping the number of fittings underground to a minimum may be preferable since the potential for leaks is reduced.

If a double layer of pipe is used, the incoming water to the heat pump should be from the deepest pipe. This provides the heat pump with the coolest water in summer and the warmest in winter.

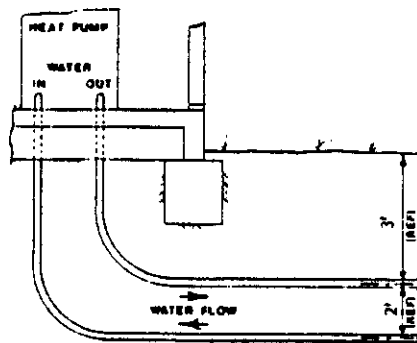

WATER FLOW/CONNECTION SCHEMATIC
DOUBLE LAYER HORIZONTAL EARTH COIL

BACKHOE TRENCHES:

If a backhoe is used, the trench will probably be about 2' wide. In a wide backhoed trench, two pipes may be placed side by side, one on each side of the trench. The pipes in the trench must be at least 2' apart.

Backfill carefully around the pipe with fine soil or sand. Do not drop clumps of clay or rock onto the pipe.

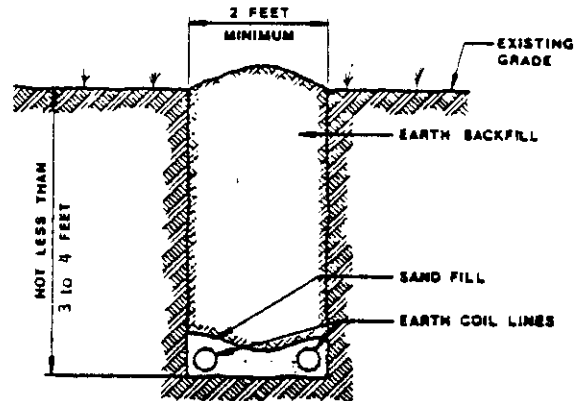

A pit may be excavated at the end of the trench to accommodate a 4' diameter return bend.

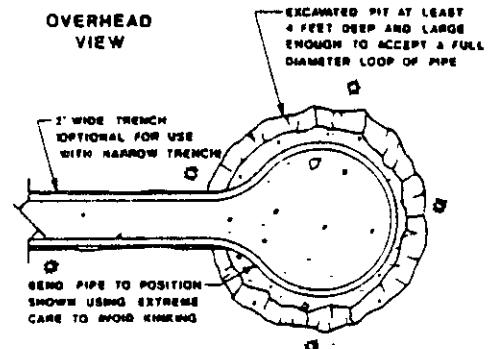

WIDE TRENCH RETURN BEND DETAIL
SINGLE OR DOUBLE LAYER
HORIZONTAL EARTH COIL

SERVICE LINES:

The recommendations for the horizontal earth coils also apply for the installation of the service lines to and from the U-bend wells and pond or lake exchanger.

Bury the service lines a minimum of 3' for single layer pipe, 3' and 5' deep for double layer pipes.

If two pipes are buried in the same trench, keep them 2' apart.

A parallel horizontal earth coupling is one in which the water flows out through a supply header, is divided equally, and flows simultaneously into two or more earth coils. It then returns to the other header. Headers are reverse return plumbed so that equal length earth coils have equal flow rates. Lengths of individual parallel earth coils must be within 10% of each other to insure equal flow in each coil.

Follow "Series Horizontal Earth Coupling" instructions on NARROW TRENCHES and BACKHOE TRENCHES.

HORIZONTAL (SERIES) SYSTEM

ONE PIPE IN TRENCH

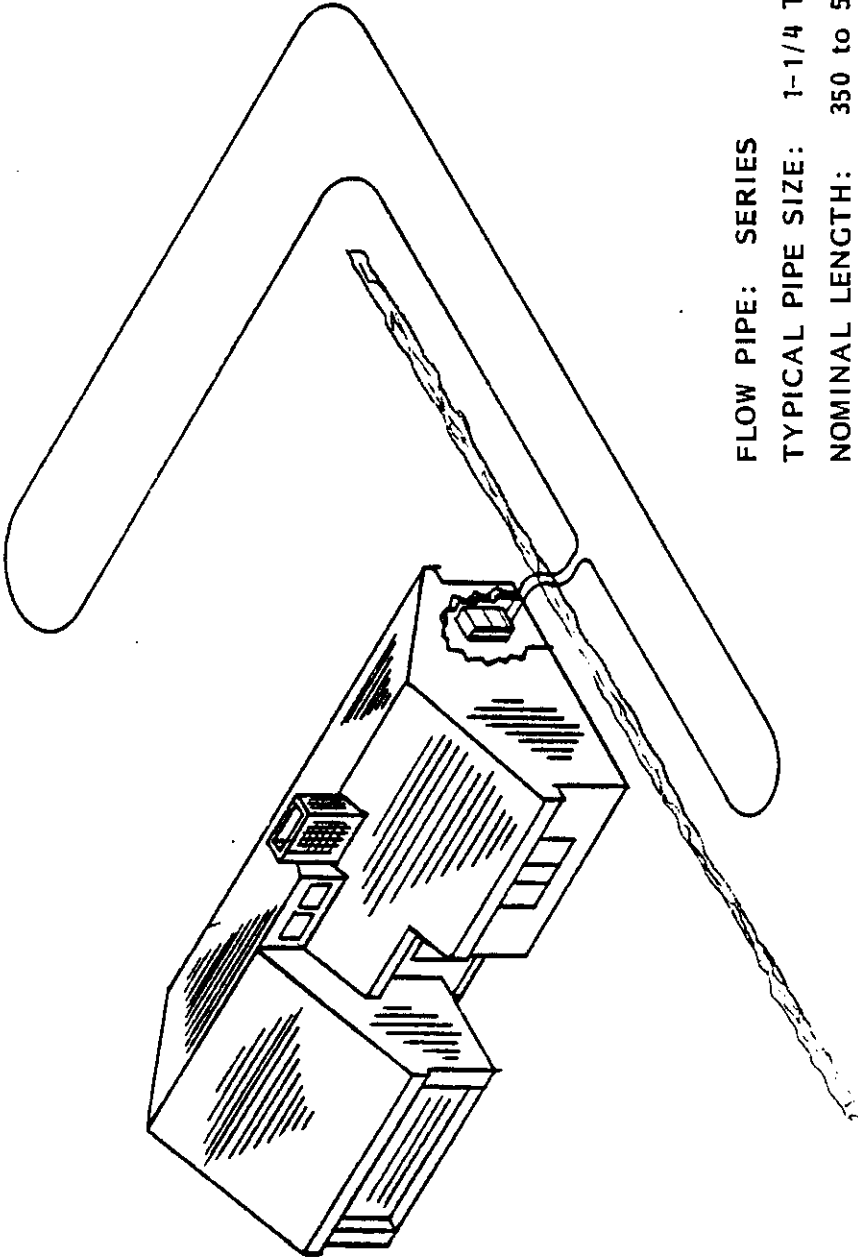

PIPE: High strength polyethylene,
fusion joined

or

polybutylene, joined with
Type 300 stainless steel
bands and screws or heat
fusion fittings

FLOW PIPE: SERIES

TYPICAL PIPE SIZE: 1-1/4 TO 2 INCHES

NOMINAL LENGTH: 350 to 500 FEET/TON

BURIAL DEPTH: 3.5 to 6 FEET

MAXIMUM HEAT PUMP SIZE: 5 TONS

TRANSFER FLUID-WATER

NOTE:

Antifreeze solution needed
in northern zones. A 25%
by volume propylene glycol
to water solution.

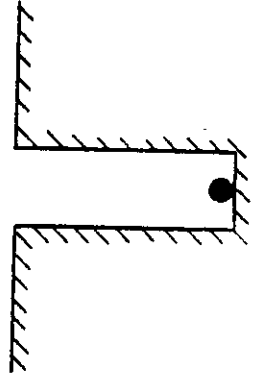

FIGURE 7.

HORIZONTAL (SERIES) SYSTEM

TWO PIPES IN SAME TRENCH

Total Piping Length: Per ton of capacity depends on location and type of soil. First pipe installed at base of trench then partially backfilled with 2' of soil for second re-turn pipe. A single loop should not exceed 2000 feet length.

PIPE - High strength polyethylene, fusion joined.
or
polybutylene, joined with Type 300 stainless steel bands and screws or heat fusion fittings

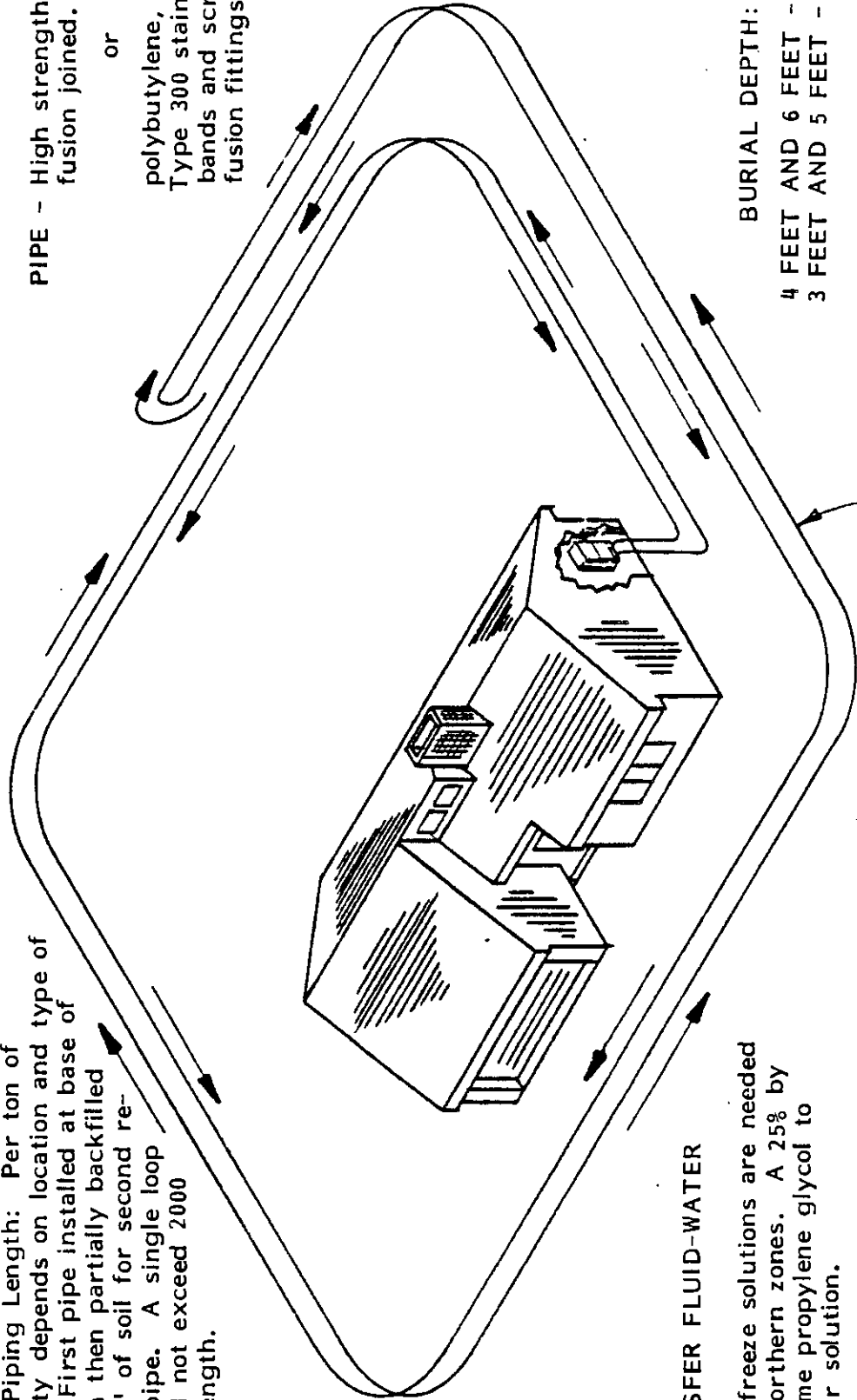

TRANSFER FLUID-WATER

NOTE: Antifreeze solutions are needed in northern zones. A 25% by volume propylene glycol to water solution.

BURIAL DEPTH:

4 FEET AND 6 FEET - SOUTHERN
3 FEET AND 5 FEET - NORTHERN

Min. Space
4 to 6 feet

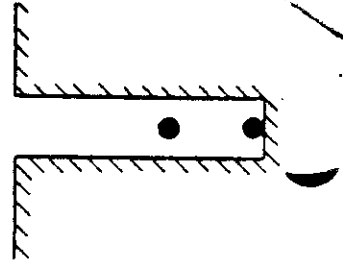

FLOW PATH: SERIES
TYPICAL PIPE SIZE: 1-1/4 TO 2 INCHES
PRACTICAL LENGTH: 210 TO 300 FEET OF TRENCH/TON
420 TO 600 FEET OF PIPE/TON

FIGURE

HORIZONTAL MULTI-LEVEL (PARALLEL) SYSTEM

Be sure the buried pipe system is properly designed for the heat pump load, soil type, climate, the pipe used, and the operating cycle pattern.

System uses 3/4" or 1" pipe, installed four ft. deep, spaced one foot apart vertically. Return bends as shown. Trenches spaced four feet apart. In Northern Zone, pipes are installed at 6 ft., 5 ft., 4 ft., and 3 ft. depths. In Southern Zones, pipes are spaced at 7 ft., 6 ft., 5 ft., and 4 ft. depths.

The use of smaller diameter pipes results in a thinner pipe wall and thus better heat transfer without sacrificing the pipe pressure rating. Parallel hookups are usually required in order to keep water pressure drops from being too high.

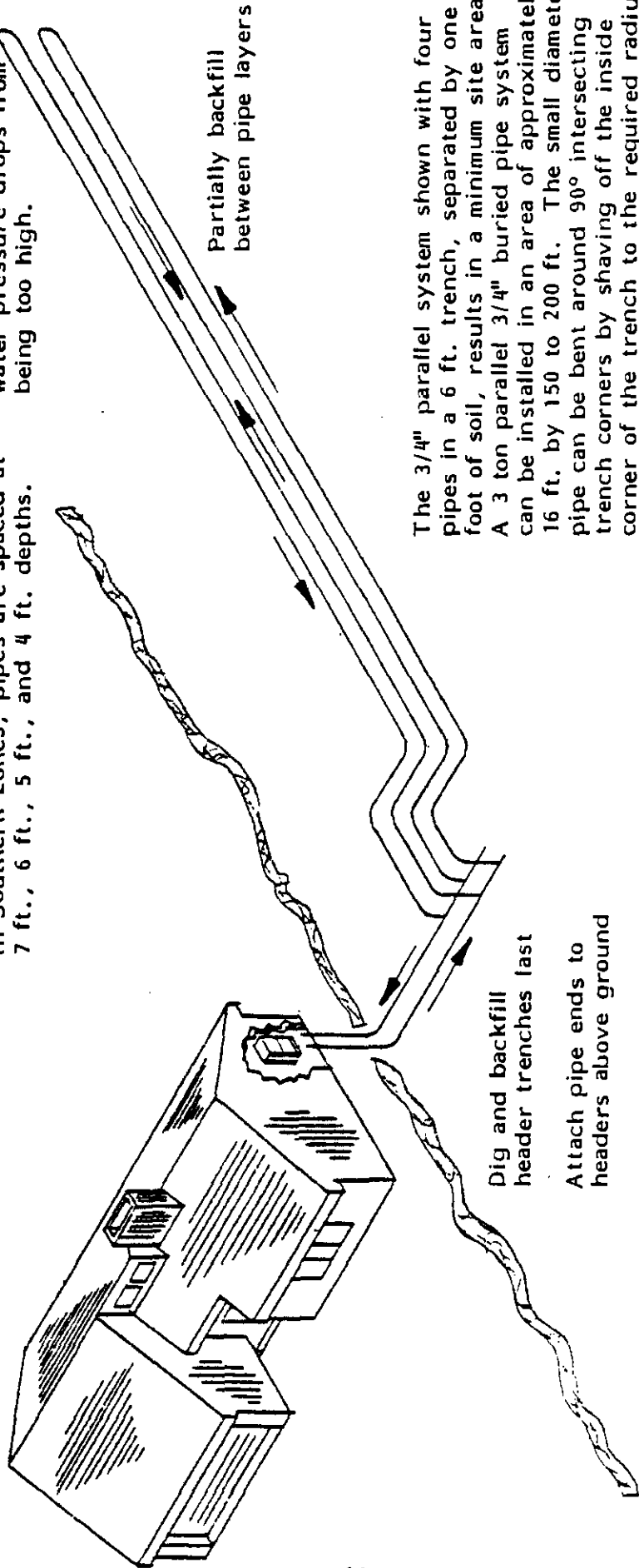

The 3/4" parallel system shown with four pipes in a 6 ft. trench, separated by one foot of soil, results in a minimum site area. A 3 ton parallel 3/4" buried pipe system can be installed in an area of approximately 16 ft. by 150 to 200 ft. The small diameter pipe can be bent around 90° intersecting trench corners by shaving off the inside corner of the trench to the required radius with a shovel to prevent kinking.

FLOW PATH: PARALLEL

TYPICAL PIPE SIZE: PARALLEL PATHS 3/4 TO 1 INCHES
 HEADERS 1-1/2 TO 2 INCHES

PARALLEL PIPE LENGTH: 500 FT. MAX. PIPE LENGTH (3/4 INCH)
 750 FT. MAX. PIPE LENGTH (1 INCH)

FIGURE 9.

TABLE 1. EARTH COUPLING CONSIDERATIONS

AREA OF CONCERN	VERTICAL SYSTEM	HORIZONTAL SYSTEM
1. LIMITATIONS	Boreholes should not exceed 300 feet depth	Single earth coil should not exceed 2000 feet length
2. PIPING MATERIAL	Polybutylene or polyethylene piping	Polybutylene or polyethylene piping
3. PIPE LENGTH	As required to fill and connect boreholes with total linear borehole depth as determined in earth coil design section of this manual	Sized for each application in linear feet per heat pump unit capacity--contact Bard Manufacturing for additional information
4. PIPING CONNECTIONS	If system requires more than one borehole, then connection can be either series or parallel--if parallel, all boreholes must be equal depth	If system requires more than 2000 feet of coil, divide into equal lengths and connect in parallel
5. SERVICE LINES	Service lines between boreholes and from house to field should be polybutylene or polyethylene buried below the frost line or to minimum 4 feet deep	If earth coil line(s) cannot connect directly to heat pump, use polybutylene or polyethylene service pipe buried below the frost line or to minimum 4 feet deep
6. PIPE FITTINGS	IPS 304 stainless steel, brass or bronze	Same as vertical
7. PIPE FITTING LUBRICANT	Use vegetable base lubricant only--petroleum base lubricant will damage piping	Same as vertical
8. CLAMPS	300 series stainless steel worm gear clamps only -check carefully: some "all-stainless" clamps contain 400 series screws which corrode when exposed to some acids in the soil	Same as vertical
9. CLOGGING	When installing, keep soil, sand, trash, etc. out of pipes until connection is made	Same as vertical
10. FLUSHING THE SYSTEM	Before connecting to heat pump, flush piping with high capacity water pump to remove debris	Same as vertical
11. SYSTEM TESTING	Before connecting to heat pump, pipe system should be tested under 50 PSI water pressure	Same as vertical

IV. Design of Earth Coil

The earth coil must be designed to provide a balance between unit capacity, soil resistance and pipe resistance. Table 2 shows typical trench, (pipe lengths) and hole depths per ton of unit capacity at local earth temperature.

Notice as the number of pipes in the trench or borehole increases the total length of the pipe increases by 20 percent for each time an additional pipe is added. Example: 400 ft. of pipe in a horizontal system will require 480 ft. of pipe when installed in two layers in same trench.

The values in the table are given for two sizes of polyethylene pipe, there will be a small difference in lengths if polybutylene pipe is used (add 5%).

To use the table for an approximate length for cost estimation, divide the capacity of the selected heat pump unit, at local ground water temperature, for both heating and cooling modes by 12,000. Then multiply this number times the length of pipe, trench or borehole depth from the table for the type of system you plan to install.

EXAMPLE: HWP36 at 60°F entering ground water has a capacity of 36,800 Btuh cooling and 38,900 Btuh heating.

$$\frac{36,800 \text{ Btuh}}{12,000} = 3.01 \times 400 \text{ ft} = 1226 \text{ feet of } 1\frac{1}{2}'' \text{ Sch 40 polyethylene pipe required for cooling.}$$

$$\frac{38,900 \text{ Btuh}}{12,000} = 3.24 \times 400 \text{ ft} = 1297 \text{ feet of } 1\frac{1}{2}'' \text{ Sch 40 polyethylene pipe required for heating.}$$

Therefore, approximately 1297 feet of 1-1/2" Sch 40 polyethylene pipe is required for a horizontal earth coupled system with one at 5 foot depth in northern climate.

This also assumes that the heating and cooling loads of the structure are equal to the capacity of the heat pump in either mode.

Bard Manufacturing will design the earth loop for you if you desire. Just complete the enclosed worksheet, Form No. F1115 and send to:

Earth Coupled Loop System Design
Bard Manufacturing Company
Box 607
Bryan, Ohio 43506

The information will be inputted into a computer and a printout with various earth loop designs will be sent to you.

TABLE 2. TYPICAL TRENCH, (PIPE LENGTHS) AND HOLE DEPTHS PER TON* FOR VARIOUS DESIGNS AND CLIMATES.

The actual trench lengths and hole depths per ton of WSHP capacity may differ significantly in your area due to soil and climate variations or other conditions.

	Number of pipes in trench and vertical spacing (4-6' Horizontal)					
	Northern Climate			Southern Climate		
	1 at 5'	2 at 3', 5'	4 at 2', 3', 4', 5'	1 at 6'	2 at 4', 6'	4 at 3', 4', 5', 6'
1 1/2" SCH. 40 3408 Polyethylene	400' (400')	240' (480')	168' (672')	400' (400')	240' (480')	168' (672')
3/4" SDR-11 3408 Polyethylene	460' (460')	275' (550')	192' (768')	460' (460')	275' (550')	192' (768')
	Number of loops in wet hole. (10-15' Horizontal spacing)					
	Northern Climate			or Southern Climate		
	1			2		
1 1/2" SCH. 40 3408 Polyethylene	140' (280')			110' (220')		
3/4" SDR-11 3408 Polyethylene	170' (340')			135' (270')		

*Capacity of unit at local ground water temperature. (Table practical for 50°F to 70°F ground water temperature in heavy soil (clay). Contact Bard Manufacturing Company, Telephone: 419-636-1194 for additional information.

Table courtesy of Ditch Witch, The Charles Machine Works, Inc.; Perry, Oklahoma.

V. The Circulation System Design

Equipment room piping design is based on years of experience with earth coupled heat pump systems. The design eliminates most causes of system failure.

Surprisingly, the heat pump itself is rarely the cause. Most problems occur because designers and installers forget that a closed loop earth coupled heat pump system is NOT like a household plumbing system.

Most household water systems have more than enough water pressure either from the well pump or the municipal water system to overcome the pressure or head loss in 1/2" or 3/4" household plumbing. A closed loop earth coupled heat pump system, however, is separated from the pressure of the household supply and relies on a small, low wattage pump to circulate the water and antifreeze solution through the earth coupling, heat pump and equipment room components.

The small circulator keeps the operating cost of the system to a minimum. However, the performance of the circulator MUST be closely matched with the pressure or head loss of the entire system in order to provide the required flow through the heat pump. Insufficient flow through the heat exchanger is one of the most common causes of system failure. Proper system piping design and circulator selection will eliminate this problem.

Bard supplies a worksheet to simplify head loss calculations and circulator selection. Refer to "Circulating Pump Worksheet" section.

Two general methods are used to pipe the water circuit in the equipment room. The first and easiest to use is to install a pump module. This module comes complete with connecting hose and heat pump adapters available from module manufacturers. A second method is to "site build" the piping at the installation.

To move the transfer fluid (water or propylene glycol and water solution) through the earth loop system and the water source heat pump, some type of circulation system is required. Design of circulation system must include provisions for the following: (See Figure 10)

1. Selection of a circulation pump or pumps for total system.
2. Providing air bleed off before start-up and running.
3. Providing for flow monitoring.
4. Positive pressure control and limiting.
5. Antifreeze charging capability.

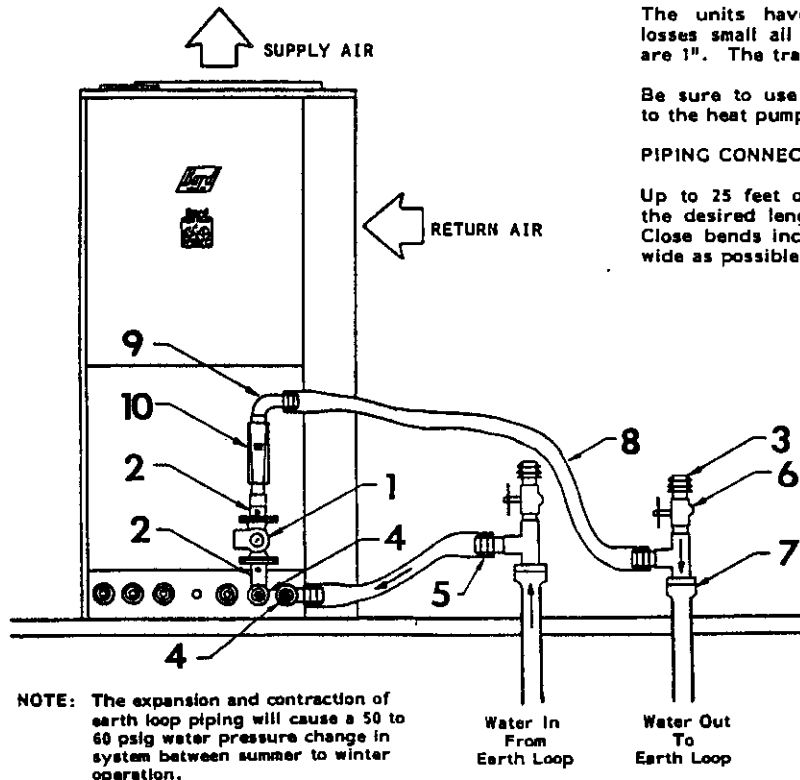

The components for a circulation system are: (See Figure 10A)

1. Circulating Pumps - are engineered for each individual system to provide the correct water flow and overcome the friction loss of the system piping. Isolation flanges or ball valves to insulate pump from system are required on pump. You need to be able to remove the pump from piping without losing the transfer fluid for repairs if ever required. Stainless steel pump body required for use with calcium chloride antifreeze.*

*Determining pressure drop and selecting a circulation pump or pumps. It is very important in selecting the circulating pump that a very accurate pressure drop calculation be made because final pressure drop the selected pump must pump against will determine the actual flow rate (GPM) that is delivered to the water source heat pump, the pumping cost and efficiency of the entire system.

2. Ball Valve and Flange
3. Barb X MIP Brass Adapter
4. Brass Test Plugs - in order to start up and troubleshoot a closed loop system properly, water in and water out temperatures at the heat pump must be monitored. A test plug is installed on one leg of each connection line. A probe thermometer can be temporarily inserted, the temperature monitored and the thermometer removed. Use one thermometer to monitor these temperatures. Using two different thermometers to measure the temperature differential can introduce large measurement errors.
5. Barb X insert brass adapter
6. Two Boiler Drains - Are located on both sides of the circulator for final filling, air purging and antifreeze addition.

The top drain should be the highest point in the equipment room piping. This will help purge air out of the system during final filling at start up.

7. PE or PB pipe to fit transition.
8. 1" reinforced flexible hose.
9. 90° street ell (brass).
10. Flow Meter (Bard part number 8603-012) - on water-in side to monitor water flow.

HEAT PUMP CONNECTIONS:

The units have various female connections. To keep head losses small all piping and components in the circulating pump are 1". The transition from 1" will be made at the heat pump.

Be sure to use a back-up wrench when installing the adapters to the heat pump.

PIPING CONNECTIONS:

Up to 25 feet of reinforced flexible hose is used. Cut hoses to the desired lengths and install with as few bends as possible. Close bends increase pipe head loss so any bends should be as wide as possible. Use the clamps to secure hoses in position.

FIGURE 10A. Closed Loop Equipment Room Piping

Drawing compliments of Oklahoma State University

NOTE: All indoor piping must be plastic if calcium chloride antifreeze is used.

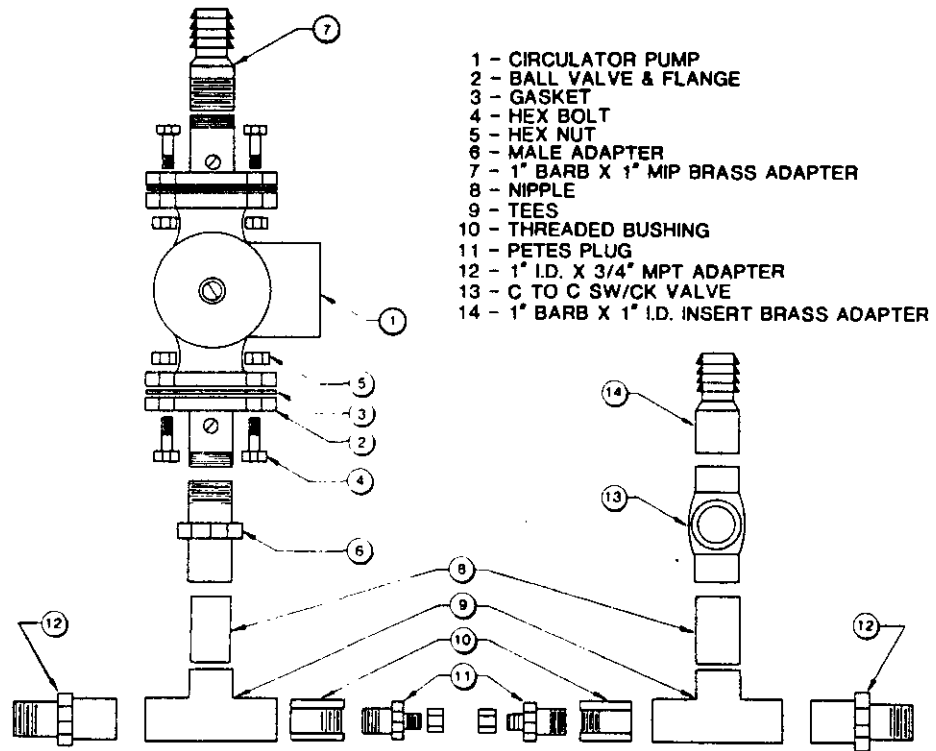

- 1 - CIRCULATOR PUMP
- 2 - BALL VALVE & FLANGE
- 3 - GASKET
- 4 - HEX BOLT
- 5 - HEX NUT
- 6 - MALE ADAPTER
- 7 - 1" BARB X 1" MIP BRASS ADAPTER
- 8 - NIPPLE
- 9 - TEES
- 10 - THREADED BUSHING
- 11 - PETES PLUG
- 12 - 1" I.D. X 3/4" MPT ADAPTER
- 13 - C TO C SW/CK VALVE
- 14 - 1" BARB X 1" I.D. INSERT BRASS ADAPTER

DETAIL A

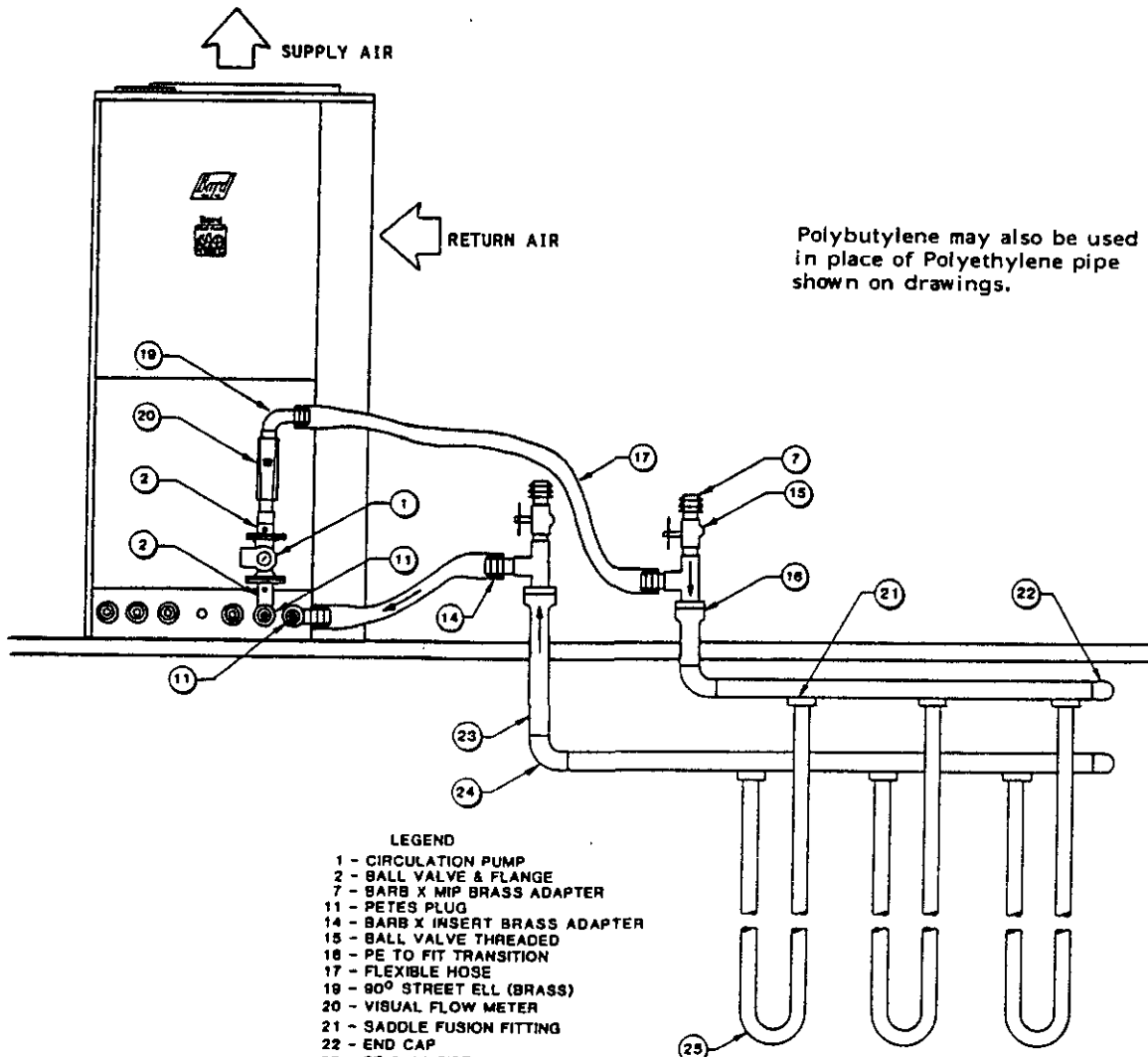

- LEGEND
- 1 - CIRCULATION PUMP
 - 2 - BALL VALVE & FLANGE
 - 7 - BARB X MIP BRASS ADAPTER
 - 11 - PETES PLUG
 - 14 - BARB X INSERT BRASS ADAPTER
 - 15 - BALL VALVE THREADED
 - 16 - PE TO FIT TRANSITION
 - 17 - FLEXIBLE HOSE
 - 19 - 90° STREET ELL (BRASS)
 - 20 - VISUAL FLOW METER
 - 21 - SADDLE FUSION FITTING
 - 22 - END CAP
 - 23 - PE 3408 PIPE
 - 24 - 90° ELL PE 3408
 - 25 - U-BEND PE 3408

DETAIL B

MULTIPLE UNIT INSTALLATION

- 1) Note Location of Check Valves for Preventing Short Circuiting
- 2) Integral Ball Flange Valve located on Pump Mount Allows Flushing of Earth Heat Exchanger with Blocked Flow thru Heat Pump
- 3) Flow Meter or Pressure Ports are Required to Monitor Heat Pump Performance

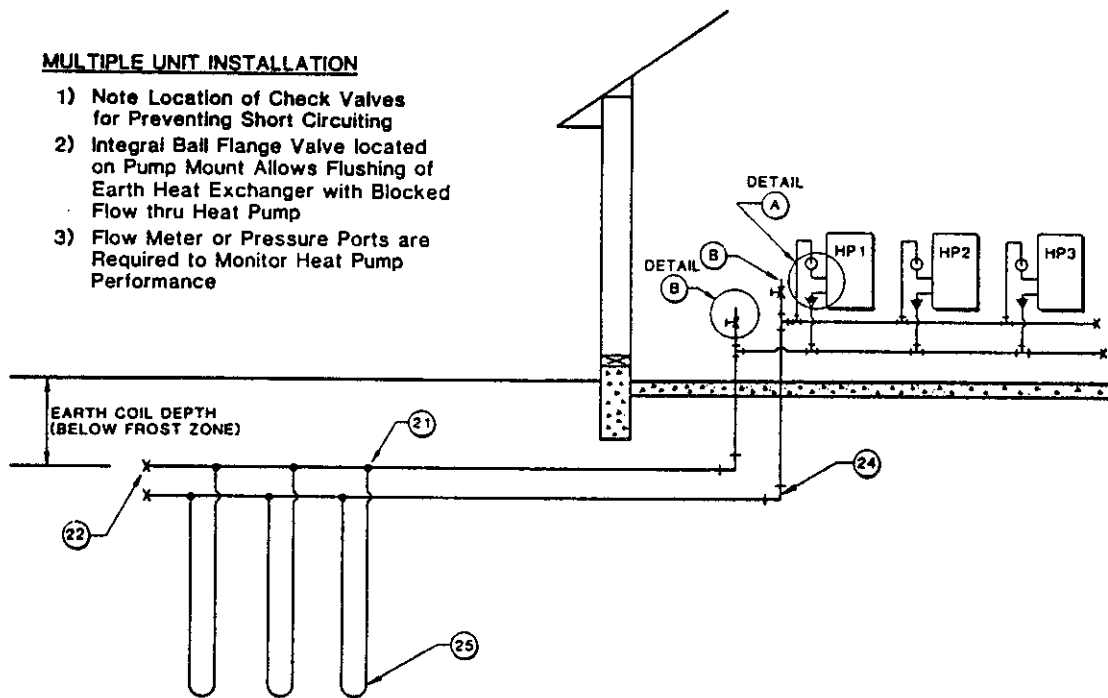

Drawings courtesy of Oklahoma State University.

The components for a circulation system are: (See Fig. 10B)

1. Flow Meter (Bard part number 8603-012) - on water-in side to monitor water flow.
2. Air Vent/Air Purger - will help bleed off any air trapped in the system.
3. Pressure Tank (Ex Trol Model No. 60) - to allow for seasonal expansion and contraction and maintain system under pressure.
4. 2 Boiler Drains - to allow filling of system and antifreeze addition.
5. Circulating Pumps - are engineered for each individual system to provide the correct water flow and overcome the friction loss of the system piping. Isolation flanges or ball valves to insulate pump from system are required on pump. You need to be able to remove the pump from piping without losing the transfer fluid for repairs if ever required. Use stainless steel for calcium chloride antifreeze.
6. Brass Test Plugs - on both "water-in" and "water-out" lines to monitor water temperatures. Use one thermometer to monitor these temperatures. Using two different thermometers to measure the temperature differential can introduce large measurement errors.

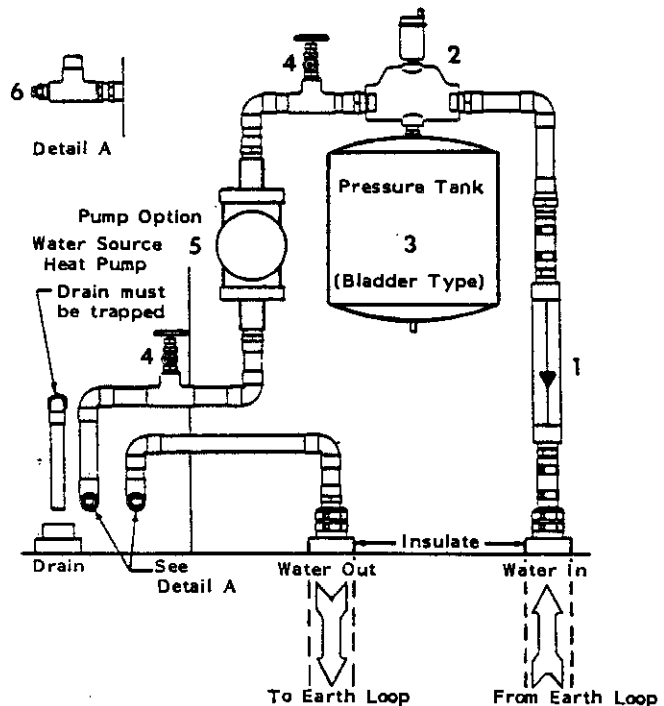

NOTE: Always use 1" piping in equipment room regardless of size fittings on water source heat pump water coil. Also use PVC plastic pipe in equipment room when using calcium chloride antifreeze.

Drawing compliments of
GEO Systems Inc.

FIGURE 10B. Alternate Closed Loop
Equipment Room Piping

CIRCULATING PUMP WORKSHEET

1. Find the Bard heat pump model used in Table 1. MODEL _____

2. Enter water coil head loss: (Table 1) _____ ft. hd.

3. Continue across Table 1 to find GPM flow required for this heat pump. _____ GPM

4. Count each elbow, tee, reducer, air scoop, flowmeter, etc., as 3 FEET OF PIPE EQUIVALENT. Add the EQUIVALENT FEET OF PIPE to the actual feet of PIPE USED. The TOTAL LENGTH is used to determine the PIPING HEAD LOSS below.

NOTE: For a parallel earth loop system figure for only one loop at this time.

Pipe Type & Size	No. Elbows, Tees Devices, Etc. *	Equiv. Ft. of Pipe	Actual Pipe Used	Total Pipe Length
_____	X3	_____	+	_____
_____	X3	_____	+	_____
_____	X3	_____	+	_____
_____	X3	_____	+	_____
_____	X3	_____	+	_____

*IF THE PIPE IS BENT AT A 2 FT. RADIUS OR LARGER, DO NOT FIGURE THE CURVE AS AN ELBOW.

5. PIPING HEAD LOSS for different types of pipe at GPM flow rate of water source heat pump. NOTE: For parallel earth loop system figure for only one loop.

Pipe Type and Size	Total Pipe Length	Piping** Head Loss (Table 2)	ft. hd.
_____	(_____ ÷ 100) X _____ =	_____	_____
_____	(_____ ÷ 100) X _____ =	_____	_____
_____	(_____ ÷ 100) X _____ =	_____	_____
_____	(_____ ÷ 100) X _____ =	_____	_____
_____	(_____ ÷ 100) X _____ =	_____	_____
SUBTOTAL			_____

**For parallel earth loops divide the heat pump GPM (line 3) by number of loops to determine flow rate through each individual loop to select piping head loss.

6. Multiply SUBTOTAL by 1.3 to obtain TOTAL HEAD LOSS FOR SYSTEM using propylene glycol antifreeze solution.

TOTAL HEAD LOSS _____ ft. hd.

7. PUMP SELECTION: Use Table 3 and flow rate, (line 3). Select the pump output which is LARGER or equal to the TOTAL HEAD LOSS FOR SYSTEM. (line 5 or 6).

Circulating Pump Model	No. Pumps
------------------------	-----------

If the TOTAL HEAD LOSS calculated in line 6 is greater than the pump outputs listed in Table 3, go to the pump manufacturer's performance curves and find the required GPM flow for the heat pump. Pump performances are listed for each pump model at different flow rates.

Series pump performance is simply a TOTAL OF THE INDIVIDUAL PUMP PERFORMANCES: if one pump can overcome 10 feet of head loss, two can overcome 20 feet of head loss, three can overcome 30 feet of head loss, etc.

REMEMBER: UNDER NO CIRCUMSTANCES MIX DIFFERENT PUMP SIZES WHEN USING PUMPS IN SERIES.

Heat Pump Model	Feet of Head	G.P.M. Flow Rate
HWP30 or HWP30	4.6	4
HWP36 or HWP36	4.6	5
WPV30A or WPVD30A	4.6	4
WPV36A or WPVD36A	4.6	5
WPV53A or WPVD53A	5.8	6
WPV62A or WPVD62A	5.8	8

PUMP OUTPUT (FEET OF HEAD) @ G.P.M. @ TOP OF COLUMN	Grundfos* Pump Models	No. of Pumps	Water Flow Rate Required in G.P.M.			
			4	5	6	8
20-42	1	11.5	11	--	--	
26-64	1	18.8	18	17.5	16	
26-64	2	37.6	36	35.0	32	
40-75	1	23.8	23.5	23	22.5	
40-75	2	47.6	47	46	43	
26-96	1	27.5	27	26	23.5	
26-96	2	55.0	54	52	47	

*Other models of circulation pumps may be used. Consult the manufacturer's specifications.

Pipe Size and Material	G.P.M. Flow Rate									
	1	1½	2	2½	3	3½	4	5	6	8
Connection Hose 1"	*	*	*	*	*	*	1.14	1.73	2.42	1.43
PVC ¾" - 200 PSI	*	*	*	*	*	*	3.7	5.7	8.0	13.5
PVC 1" - 200 PSI	*	*	*	*	*	*	1.0	1.9	2.7	4.2
Copper ¾"	*	*	*	*	*	*	4.3	6.3	8.9	15.0
Copper 1"	*	*	*	*	*	*	1.5	1.9	2.7	4.5
Polybutylene 1" SDR 13.5	.02	.30	.51	.74	1.04	1.36	1.79	2.71	3.80	6.48
" 1½" SDR 13.5	*	*	*	*	.154	*	.263	.397	.556	.948
" 1¾" SDR 17	*	*	*	*	.065	.116	.138	.166	.233	.397
" 2" SDR 13.5	*	*	*	*	.042	*	.071	.108	.151	.259
" 2" SDR 17	*	*	*	*	.021	.023	.037	.55	.078	.133
Polyethylene ¾" SDR -11	.23	.62	1.02	1.5	2.08	2.7	3.37	5.04	6.93	11.4
" 1" SDR -11	.02	.35	.51	.72	.92	1.18	1.73	1.78	2.38	3.93
" 1½" SCH. 40	*	*	.05	.07	.09	.139	.162	.254	.347	.578
" 2" SCH. 40	*	*	*	*	.023	.023	.046	.069	.092	.162

NOTES: 1. These head losses are for water at 40°F temperature.
2. Count each elbow, tee, reducer, air scoop, flow meter, etc., as 3 feet of equivalent pipe length and add to actual measured pipe length for total length.
3. To adjust the total earth loop piping head loss for propylene glycol antifreeze and water solution at 35°F, multiply the total earth loop head loss for water by 1.3

**PRESSURE DROP CALCULATIONS TO
SELECT CIRCULATION PUMP**

Transfer fluid requirements for closed-loop, earth-coupled heat pump systems varies with fluid temperature and heat pump size. To determine the circulation pump size requirement, the system flow rate requirements (GPM for heat pump used) and total system pressure drop in feet of head loss. From these two pieces of information a circulation pump can be selected from the pump manufacturer performance curves.

The fluid (water) flow rate and water coil pressure drop are found in the manufacturer's heat pump specifications or Table 1 of this section for Bard water source heat pumps. The head loss for different pipe materials and sizes per 100 feet are found in Table 2 of this section and a quick pump selection table for flow rates that match Bard water source heat pumps are in Table 3 of this section.

Following are two examples of how to determine the head loss of earth loops. First example will be a series horizontal system and the second example will be a parallel vertical system.

EXAMPLE 1

Given:

- A. Series horizontal system.
- B. Bard HWP36 water source heat pump to be used.
- C. Heat pump water flow requirement is 5 GPM with a 4.6 ft. hd. loss (see Table 1).
- D. Earth loop 1200 ft. 1-1/2" SDR 15 polybutylene pipe.
- E. 20 ft. 1" copper pipe connecting earth loop to water source heat pump.
- F. The circulation pumping system lay out to be similar to Figure 10.

CIRCULATING PUMP WORKSHEET

1. Find the Bard heat pump model used in Table 1. MODEL HWP36
2. Enter water coil head loss: (Table 1)
3. Continue across Table 1 to find GPM flow required for this heat pump. 5 GPM
4. Count each elbow, tee, reducer, air scoop, flowmeter, etc., as 3 FEET OF PIPE EQUIVALENT. Add the EQUIVALENT FEET OF PIPE to the actual feet of PIPE USED. The TOTAL LENGTH is used to determine the PIPING HEAD LOSS below.

NOTE: For a parallel earth loop system figure for only one loop at this time.

Pipe Type & Size	No. Elbows, Tees & Devices, Etc. *	Equiv. Ft. of Pipe	Actual Pipe Used	Total Pipe Length
<u>1" COPPER</u>	<u>20</u>	X3 <u>60</u>	+ <u>20</u>	<u>80</u>
<u>1 1/2" PE</u>	<u>NONE</u>	X3 <u>NONE</u>	+ <u>1200</u>	<u>1200</u>
_____	_____	X3 _____	+ _____	_____
_____	_____	X3 _____	+ _____	_____
_____	_____	X3 _____	+ _____	_____

*IF THE PIPE IS BENT AT A 2 FT. RADIUS OR LARGER, DO NOT FIGURE THE CURVE AS AN ELBOW.

5. PIPING HEAD LOSS for different types of pipe at GPM flow rate of water source heat pump. NOTE: For parallel earth loop system figure for only one loop.

Pipe Type & Size	Total Pipe Length	Piping** Head Loss (Table 2)
<u>1" COPPER</u>	<u>80</u> ; 100	X <u>1.9</u> =
<u>1 1/2" PE</u>	<u>1200</u> ; 100	X <u>.191</u> =
_____	(_____) ; 100	X _____ =
_____	(_____) ; 100	X _____ =
_____	(_____) ; 100	X _____ =

**For parallel earth loops divide the heat pump GPM (line 3) by number of loops to determine flow rate through each individual loop to select piping head loss.

SUBTOTAL

6. Multiply SUBTOTAL by 1.3 to obtain TOTAL HEAD LOSS FOR SYSTEM using propylene glycol antifreeze solution.

TOTAL HEAD LOSS

7. PUMP SELECTION: Use Table 3 and flow rate, (line 3). Select the pump output which is LARGER or equal to the TOTAL HEAD LOSS FOR SYSTEM. (line 6 or 8).

GRUNDFOS
20-42
Circulating Pump Model No. Pumps 1

If the TOTAL HEAD LOSS calculated in line 6 is greater than the pump outputs listed in Table 3, go to the pump manufacturer's performance curves and find the required GPM flow for the heat pump. Pump performances are listed for each pump model at different flow rates.

Series pump performance is simply a TOTAL OF THE INDIVIDUAL PUMP PERFORMANCES: if one pump can overcome 10 feet of head loss, two can overcome 20 feet of head loss, three can overcome 30 feet of head loss, etc.

REMEMBER: UNDER NO CIRCUMSTANCES MIX DIFFERENT PUMP SIZES WHEN USING PUMPS IN SERIES.

EXAMPLE 2

Given:

- A. Vertical system.
- B. Bard WPV53 water source heat pump.
- C. Heat pump water flow requirements are 6 GPM with a 5.8 ft. hd. loss (see Table 1).
- D. Heat pump connected to circulation pump module and earth coil with 25 ft. of 1" I.D. connection hose.
- E. Pressure drop through flow meter and air vent system and connections to coil of water source heat pump 1" copper.
- F. Three loops (4 tubes) with 373 ft. pipe each.
- G. Loops are 3/4" SDR-11 polyethylene pipe.
- H. Flow rate through each loop will be 1/3 of total flow through total earth loop system because there are three loops and each one will have an equal share of the total flow rate.
 $6 \text{ GPM} \div 3 = 2 \text{ GPM Per Loop}$
- I. 240 ft. of 1-1/2" SCH 40 polyethylene pipe headers.

CIRCULATING PUMP WORKSHEET

- Find the Bard heat pump model used in Table 1. MODEL WPV53A
- Enter water coil head loss: (Table 1) 5.8 ft. hd.
- Continue across Table 1 to find GPM flow required for this heat pump. 6 GPM
- Count each elbow, tee, reducer, air scoop, flowmeter, etc., as 3 FEET OF PIPE EQUIVALENT. Add the EQUIVALENT FEET OF PIPE to the actual feet of PIPE USED. The TOTAL LENGTH is used to determine the PIPING HEAD LOSS below.
NOTE: For a parallel earth loop system figure for only one loop at this time.

Pipe Type & Size	No. Elbows, Tees & Devices, Etc. *	Equiv. Ft. of Pipe	Actual Pipe Used	Total Pipe Length
<u>1" HOSE</u>	<u>NA</u>	<u>X3</u>	<u>NA</u>	<u>25</u>
<u>1" COPPER</u>	<u>14</u>	<u>X3</u>	<u>42</u>	<u>52</u>
<u>3/4" PE</u>	<u>4</u>	<u>X3</u>	<u>12</u>	<u>373</u>
<u>1 1/2" PE</u>	<u>8</u>	<u>X3</u>	<u>24</u>	<u>240</u>
		<u>X3</u>		

*IF THE PIPE IS BENT AT A 2 FT. RADIUS OR LARGER, DO NOT FIGURE THE CURVE AS AN ELBOW.

- PIPING HEAD LOSS for different types of pipe at GPM flow rate of water source heat pump. NOTE: For parallel earth loop system figure for only one loop.

Pipe Type and Size	Total Pipe Length	Piping** Head Loss (Table 2)
<u>1" HOSE</u>	<u>(25 ÷ 100) X</u>	<u>2.42</u>
<u>1" COPPER</u>	<u>(52 ÷ 100) X</u>	<u>2.7</u>
<u>3/4" PE</u>	<u>(373 ÷ 100) X</u>	<u>1.02</u>
<u>1 1/2" PE</u>	<u>(240 ÷ 100) X</u>	<u>.347</u>
	<u>() ÷ 100) X</u>	<u> .</u>

**For parallel earth loops divide the heat pump GPM (line 3) by number of loops to determine flow rate through each individual loop to select piping head loss.

- Multiply SUBTOTAL by 1.3 to obtain TOTAL HEAD LOSS FOR SYSTEM using propylene glycol antifreeze solution.

- PUMP SELECTION: Use Table 3 and flow rate, (line 3). Select the pump output which is LARGER or equal to the TOTAL HEAD LOSS FOR SYSTEM. (line 5 or 6).

If the TOTAL HEAD LOSS calculated in line 6 is greater than the pump outputs listed in Table 3, go to the pump manufacturer's performance curves and find the required GPM flow for the heat pump. Pump performances are listed for each pump model at different flow rates.

Series pump performance is simply a TOTAL OF THE INDIVIDUAL PUMP PERFORMANCES: if one pump can overcome 10 feet of head loss, two can overcome 20 feet of head loss, three can overcome 30 feet of head loss, etc.

REMEMBER: UNDER NO CIRCUMSTANCES MIX DIFFERENT PUMP SIZES WHEN USING PUMPS IN SERIES.

F1129-406

<u>5.8</u>	ft. hd.
<u>.605</u>	ft. hd.
<u>1.40</u>	ft. hd.
<u>3.93</u>	ft. hd.
<u>.92</u>	ft. hd.
	ft. hd.
<u>12.66</u>	ft. hd.
<u>16.46</u>	ft. hd.

26-64 1
Circulating Pump Model No. Pumps

VI. Freeze Protection

Antifreeze solutions used in earth loop system must be non-toxic and non-corrosive. Non-toxic in case there is a leak in the loop system so the ground water will not be contaminated and non-corrosive to protect the metal components used in the circulation pumps and other system components.

When the local well water temperature is below 65°F, the water in the earth loop should be protected from freezing down to 18°F. The recommended antifreeze material is propylene glycol. To determine the amount of antifreeze to be added to the water in the earth loop, calculate the approximate volume of water in the system by using the following table which gives the gallons of water per 100 feet of pipe.

TABLE 4

PIPE MATERIAL	NOMINAL PIPE SIZE	GALLONS PER 100' OF PIPE
Polyethylene		
SDR-11	3/4	3.02
SDR-11	1	4.73
SDR-11	1-1/4	7.52
SDR-11	1-1/2	9.85
SDR-11	2	15.40
SCH 40	3/4	2.77
SCH 40	1	4.49
SCH 40	1-1/4	7.77
SCH 40	1-1/2	10.58
SCH 40	2	17.43
Polybutylene		
SDR-17 IPS	1-1/2	11.46
SDR-17 IPS	2	17.91
SDR-13.5 CTS	1	3.74
SDR-13.5 CTS	1-1/4	5.59
SDR-13.5 CTS	1-1/2	7.83
SDR-13.5 CTS	2	13.38
Copper	1	4.3

Add two gallons for the equipment room devices and heat pump.

PROPYLENE GLYCOL

Where the ground water at 100 ft. depth is less than or equal to 66°F, a 20% by volume solution of propylene glycol is required. The percentage of antifreeze depends on geographical location. A 20% by volume solution of propylene glycol is required for 18°F freeze protection.

Example: For 100 gallons of water in system, 20 gallons of propylene glycol is required.

Two short pieces of hose, a bucket and a small submersible pump are needed to add the antifreeze.

Block the system by closing a ball valve. Blocking flow prevents the antifreeze from being pumped into one boiler drain and out the other.

Attach hoses to the boiler drains. Run the uppermost hose to drain. Connect the other hose to the submersible pump in the bucket. Put full strength propylene glycol into the bucket and pump in the amount needed to give the required percentage by volume. When the required amount has been pumped in, turn off the pump, close the boiler drains, disconnect the hoses and open the isolation flange or gate valve.

CALCIUM CHLORIDE

A 20% by weight solution calcium chloride and water may also be used as an antifreeze in the earth coupled system. It is also non-toxic, a better heat conductor and less expensive than propylene glycol. However, it is mildly corrosive. Multiply the gallons of water in the earth loop system by 1.4841 to find the pounds of 94-97% pure calcium chloride required for 18°F freeze protection.

VII. System Start Up

Once the ground water source heat pump system is completely installed, the final step is to start the system and check for proper operation. The proper sequence on startup is to begin with the water side of the system, then proceed to the air side.

FLUSH THE SYSTEM PIPING--DO NOT connect the water lines from the earth coupled loop to the unit before the water lines have been flushed. Flushing will remove any debris and air that may be trapped in the piping. If water is circulated through the unit without first flushing the water loop piping, the heat pump unit may be damaged. Therefore, follow this procedure carefully before connecting to the unit.

When an earth coupled system, connect the piping to a flushing rig (Figure 13) that can be easily constructed from a 55 gallon drum, 1 hp water pump, and some relatively inexpensive piping. Fill the earth coupling as much as possible then hook one side of the earth coupling to the pump and return the other side of the earth coupling to the top of the barrel. Fill the barrel and turn on the pump. The barrel must be kept at least half full of water to avoid sucking air into the system.

When the proper flushing connections have been made, check to be sure all accessible fittings are secure and tight, and any valves in the line are open. Start the pump and let the water circulate for at least 20-30 minutes. This will allow enough time for any entrained air or debris to be purged from the system. With an earth coupled system, check for possible leaks in the loop by establishing 50 PSIG water pressure in the line and checking the gauge after 15 minutes. If there are no leaks in the line, the pressure will not drop. If the pressure in the line falls by more than 5 PSIG, it may be necessary to dig holes at the coupling locations to check for loose or failed couplings. With all ground water systems, check carefully for any visible signs of water leakage before digging or boring down to any coupling locations. If visible leakage is found, correct the problem and retest the system. If no visible signs of leakage exist, and the piping system is losing more than 5 PSIG in 15 minutes, then proceed to locate the source of the leakage. Remember for proper system operation, there can be no leakage in the water loop.

Pipe Size	1"	1 1/2"	2"
Flow, GPM to start purging	3	7	11
Flow, GPM for rapid purging	5	13	21

BOILER DRAINS -- Boiler drains are located on both sides of the circulator for final filling, air purging and antifreeze addition.

The top drain should be the highest point in the equipment room piping. This will help purge air out of the system during final filling at start up.

FLOW RATE ADJUSTMENT -- When the earth loop has been completely flushed and leak tested, remove the flexible connection from the pipe ends and hook up the supply and return lines to the appropriate connections on the water source heat pump, turn on the circulator pump and let the water circulate through the system for five minutes. DO NOT allow the heat pump to operate yet. The proper sequence is to allow water to circulate, then adjust the flow rate, then operate the heat pump.

If the circulator does not operate immediately, turn off the electrical power to the heat pump, close the isolation flanges, remove the indicator plug, insert a small blade screwdriver into the motor shaft and turn gently until the shaft moves freely. Replace the indicator plug, open the isolation flanges, wait a few minutes then restart the pump.

The flow rate should be the desired operating flow of the model of water source heat pump being used (see manufacturer's specifications). Water flow should not be less than that of the minimum flow rate required for the model of water source being used. If water flow is less than system calculations indicate, check your calculations. If the calculations are correct, there is some trapped air or restriction in the water circuit.

VIII. Other Items to be Followed

- A. Follow the installation instructions for the water source heat pump model being used to check the operation of the refrigeration cycle and specifics in installation in structure. The equipment manual will also show the electrical hookup and air flow requirements.
- B. Follow the Air Conditioning Contractors of America, "Manual D" for proper duct design for the air side of the system.

FIGURE 13. PORTABLE RIG FOR FLUSHING EARTH COUPLED SYSTEMS

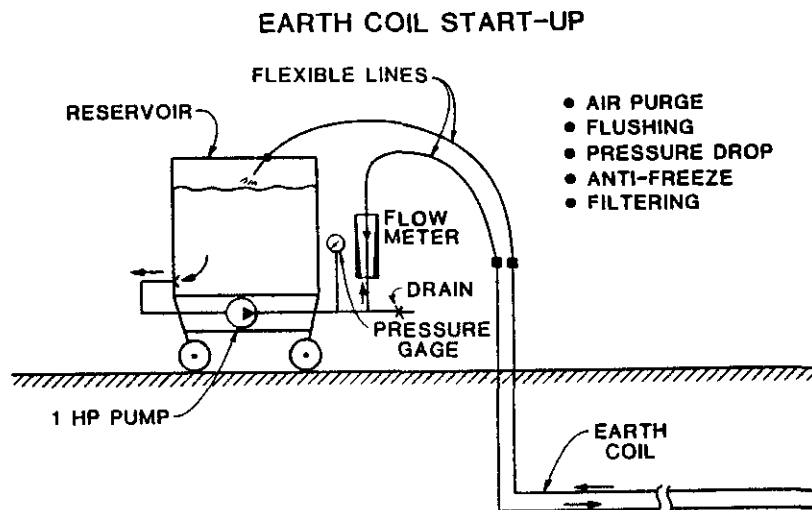

ACKNOWLEDGMENTS

1. Albertson, P. 1983, Pamphlet "Earth-Coupled Water Source Heat Pump," Ditch Witch, Perry, OK.
2. Bose, James E. et al. 1984, "Closed-Loop Ground-Coupled Heat Pump Design Manual," Oklahoma State University, Stillwater, OK.
3. Braud, H. J., Klimkowski, H. and Oliver J. 1983, "Earth-Source Heat Exchanger for Heat Pumps", Louisiana State University, Baton Rouge, LA.
4. Braud, H. J., Baker, F.E. and Smilie, J. L. 1984, "Earth-Coupled Heat Pump Systems", Louisiana Cooperative Extension Service, Baton Rouge, LA.
5. Eitelman, L. 1983, Letter "Pipe Pressure Loss Tables for Polyethylene Pipe," McElroy Manufacturing, Inc., Tulsa, OK.
6. Hatherton, D. L. 1983 "Trenched and Drilled Earth-Coupled Heat Pump Systems", Ground Water Energy Newsletter, (Sept; Oct. 1983), Worthington, Ohio.
7. Hawkinson, G. 1984, Letter "Pipe Head Loss Tables for Polybutylene Pipe", Vanguard Plastics, Inc. McPherson, KA.
8. Partin, James R. 1981, "Drilled and Trenched Earth-Coupled Heat Pump Exchangers," Stillwater, OK.

IX. Closed Loop Systems Suspended in Ponds and Lakes

The pond or lake should be approximately two acres in size with a volume of water equal to twice the size of the house being heated. A larger pond will be required in colder climates. The zone where the exchanger is placed should remain above 40°F in winter.

CAUTION: The performance of this type of system sometimes is hard to predict due to water stratification and other factors. Be very cautious about using this type of system. Again, make sure the ground water heat pump is designed to operate at lower water temperatures.

LAKE EXCHANGER CONSTRUCTION:

Lengths of 3/4" copper tubing 20 ft. long should be soldered or brazed to 1" copper headers on 1 ft. centers. The headers should be reverse return plumbed for balanced flow in the legs. Refer to the drawing.

Connect the lake exchanger to the polybutylene service lines by using a brass bushing and a copper male adapter. **DO NOT** thread plastic into metal fittings to make the connection. 1 1/2" IPS PB service lines are appropriate for systems up to 5 tons.

CALCULATING HEAD LOSS:

Locate the exchanger size in the table. Multiply the length of service lines in 100s of feet by the service line head loss in ft/100 ft. and add that number to the exchanger head loss to get the total loss of the exchanger and service lines.

PLACEMENT:

Place the exchanger near the bottom of the lake at least 10-12 ft. below the lake's lowest operating water level. Popular methods of placement include suspending the exchanger under a dock or pier, or tied to a set of old automobile tires which provide spacing of the exchanger above the lake bottom. Do not allow the exchanger to be placed in the silt on the lake bottom. Best performance is obtained where the exchanger is in open water.

SERVICE LINES:

Bury the service lines a minimum of 4' deep or below the frost line, whichever is deeper, across the shore and keep them separated about 2' in the trench.

Follow the "Horizontal Earth Coil Installation" instructions for the service lines to the lake exchanger.

ANTIFREEZE:

The equivalent of 25% propylene glycol is required.

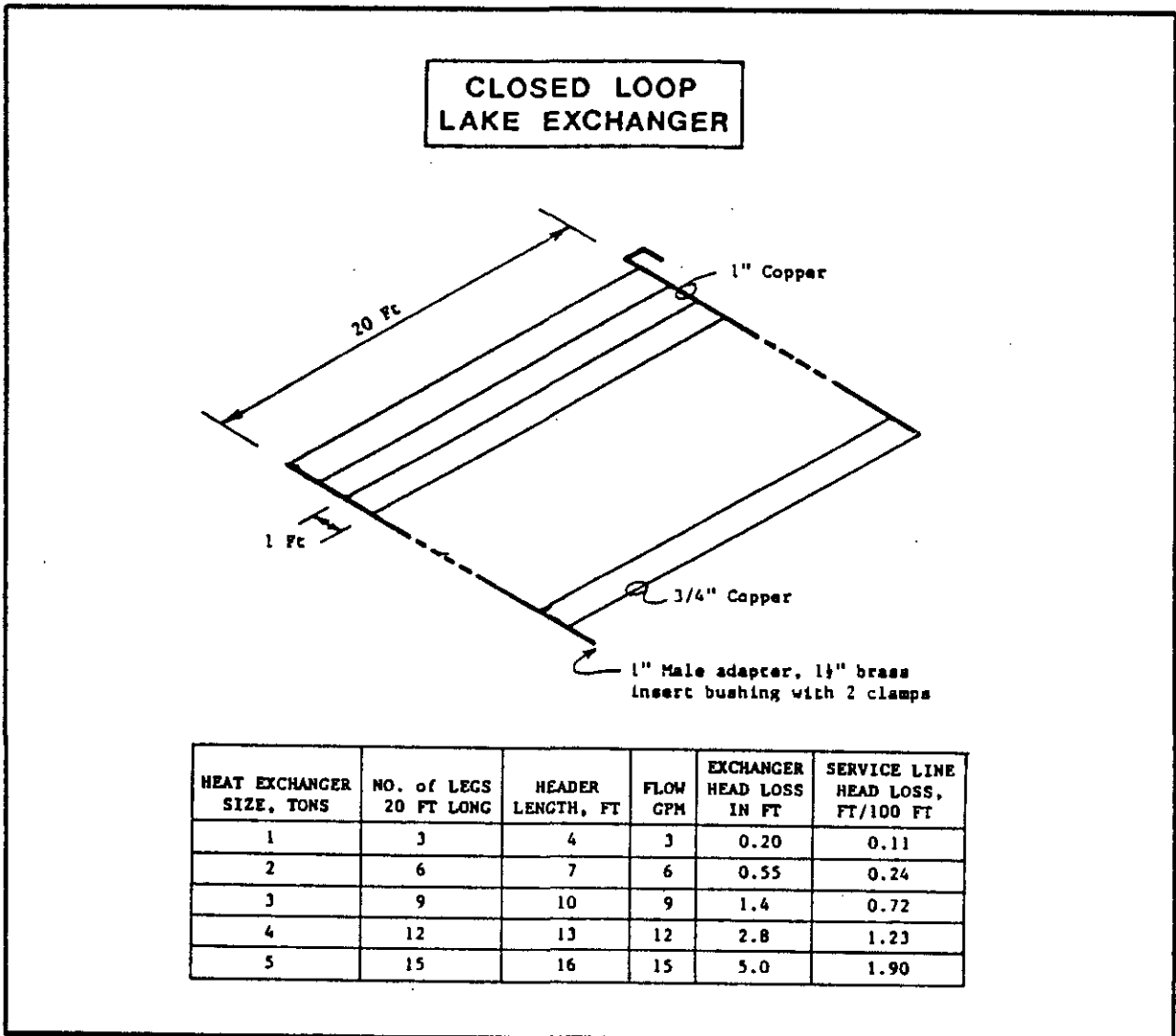

TYPICAL WIRING OF CIRCULATION PUMP OR PUMPS AND WATER SOURCE HEAT PUMP

NOTE: Some systems may only require one circulating pump. In that case use only one set of the contacts such as T1 & L1.

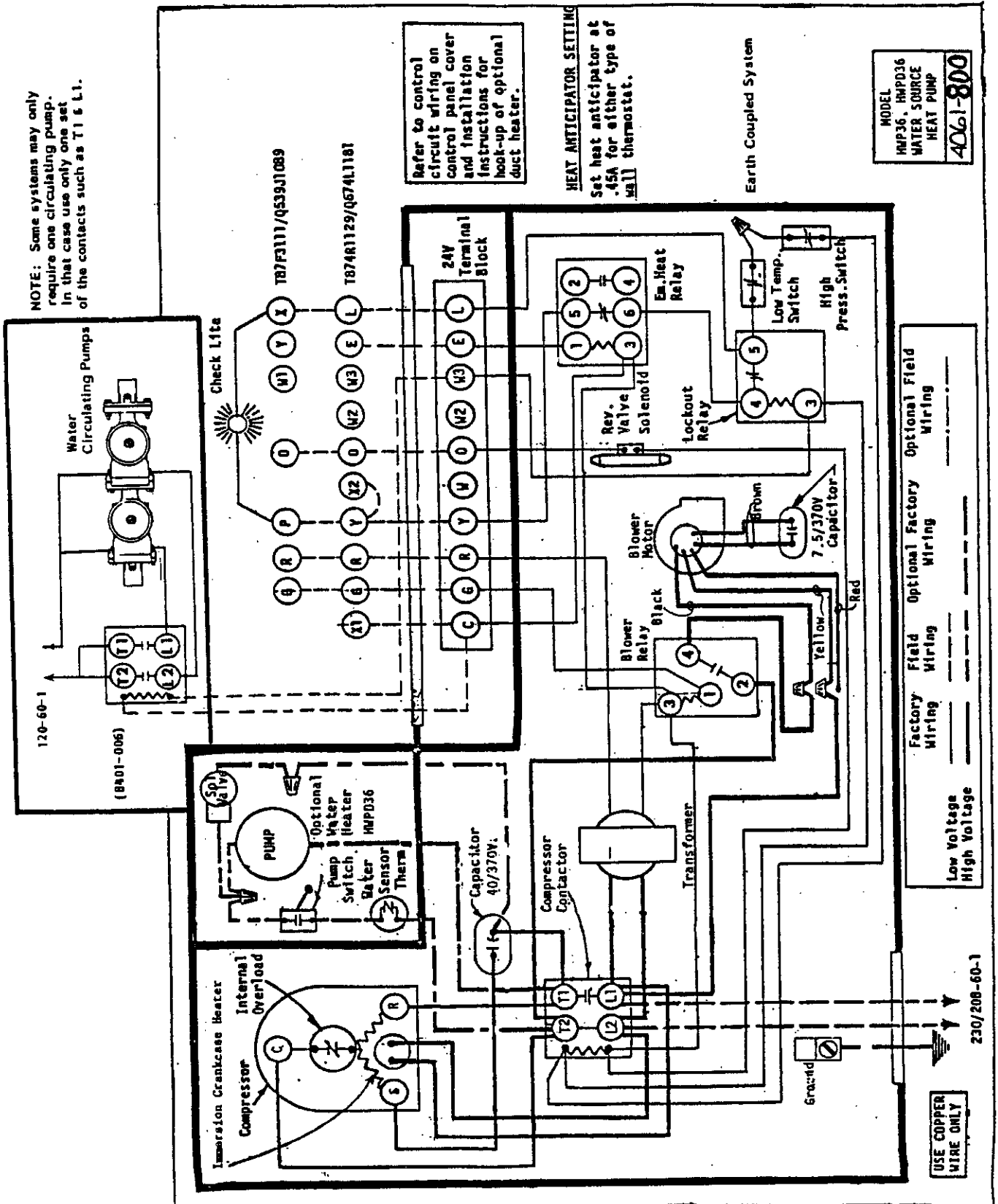

Refer to control circuit wiring on control panel cover and instructions for hook-up of optional duct heater.

HEAT ANTICIPATOR SETTING
Set heat anticipator at .45A for other type of wall thermostat.

Earth Coupled System

MODEL
HMP36, HMPD36
WATER SOURCE
HEAT PUMP
4061-800

Factory Wiring	Optional Factory Wiring	Optional Field Wiring
Low Voltage	High Voltage	

USE COPPER WIRE ONLY

230/208-60-1

INSTALLATION CHECKLIST

BURIED PIPE SYSTEM DESIGN

- Heat Pump Sized.
 - Water pump pressure, GPM, specified.
 - Type, diameter, length of pipe.
 - Type of joint specified.
 - Climate, zone location.
 - Designed heating & cooling load specified.
 - Soil moisture and type specified.
 - Heat pump COP* specified (*Coefficient of Performance).
 - Pipe depth specified.
 - Need for sand or drip system specified.
 - Backfilling specified.
 - (Other) _____
-

PLANNING

- Buried pipe system design completed.
 - Pipe and fittings as specified on layout are on hand.
 - Flagging of existing buried conduit and WSHP pipe route is scheduled.
 - Soil and rock characteristics have been determined.
 - Size and type machine is scheduled. Larger trencher can complete job faster if weather is limiting factor.
 - Alligator chain with Tungsten carbide mining teeth scheduled for installation, if needed.
 - Backhoe scheduled for installation, if needed.
 - Pipe, fitting, clamps, fusion machine scheduled.
 - Testing pump, reservoir, valve gauge assembly scheduled with correct size fittings for pipe.
 - Sand scheduled, if needed.
 - Buried drip irrigation pipe scheduled if seasonal soil moisture control desired.
 - (Other) _____
-

TRENCHING

- Is jobsite flagged for buried conduits and WSHP pipe route?
 - Alligator chain with Tungsten carbide mining teeth for frozen soil and rock.
 - Feed chute for unstable soils.
 - Backhoe for access holes, large rocks.
 - Tongs, narrow hoes for removing loose rocks. Shovels, including long handle and narrow.
 - Fuel, oil, grease gun, tools, fuel filter cartridge, tire gauge, trailer spare.
 - Water hose.
 - Extension cord, trouble light, flood light, flashlight.
 - Boards, plywood strips for intersecting trenches, claw hammer, nails.
 - (Other) _____
-

PIPE INSTALLATION AND TESTING

- Correct size, length, and type of pipe, DO NOT USE PVC PIPE.
 - Fittings, fusion machine, heavy extension cord.
 - Pipe cutter.
 - Type 300 stainless steel clamps. Make sure screws are not plated steel.
 - Torque wrench for clamps.
 - High pressure water pump with reservoir, valves, gauges, correct fittings for pipe.
 - Anti-freeze.
 - Sand, if needed.
 - Buried drip irrigation pipe, if needed.
 - (Other) _____
-

SAMPLE OF COMPUTER PRINTOUT

BE 101685

BARD EARTH LOOP DESIGN

SEND TO: JOHN SMITH HEATING & COOLING DATE:10/16/85
WILLOW ST.
BRYAN, OHIO

CONTRACTOR OR JOB NAME OR NO.: BRYAN PROFESSIONAL BUILDING
JOB GEOGRAPHIC LOCATION: BRYAN, OHIO

BUILDING LOAD & LOCAL EARTH DATA

NOTES:

BUILDING COOLING GAIN 63452 BTUH
BUILDING HEATING LOSS 53719 BTUH

LOCAL GROUND WATER TEMPERATURE 52 F
APPROX. EARTH TEMP. AUG. 20TH 52 AND FEB 20TH 52 @ 100 FT/ DEPTH
ANNUAL ANTICIPATED SOIL TEMP. SWING DEG. F 0
LOCAL SOIL CONDITIONS: WINTER WET SOIL (SATURATED OR AVERAGE ROCK
SUMMER WET SOIL (SATURATED OR AVERAGE ROCK

BARD HEAT PUMP MODELS: WPV62A OR WPVD62A
WITH 2 KW OF RESISTANCE ELECTRIC HEAT
FOR 100% BACK UP RESISTANCE HEAT 15 KW IS REQUIRED

WSHP PERFORMANCE

UNIT COOLING CAP. @ 52 EARTH TEMPERATURE 61340 BTUH 12.33 EER
UNIT HEATING CAP. @ 52 EARTH TEMPERATURE 56360 BTUH 2.73 COP

APPROXIMATE WATER TEMP. (WARMEST) 89 F TO (COLDEST) 36
F ANTICIPATED IN THE SYSTEM DURING NORMAL ANNUAL OPERATION
UNIT COOLING CAP. @ 89 ENTERING WATER TEMP. 56070 BTUH
UNIT HEATING CAP. @ 36 ENTERING WATER TEMP. 47120 BTUH
UNIT OPERATING WATER TEMP. RANGE 25 TO 105 @ 8 GPM

DESIGN FOR VERTICAL EARTH LOOP

600 LENGTH OF BORE HOLE FOR UNIT ABOVE
1380 LENGTH OF PIPE FOR UNIT

ONE LOOP IN BORE HOLE
PE SCH 40 1-1/2 IN. PIPE 1.61 I.D.
TOTAL BORE LENGTH TO BE DRILLED IN MULTIPLE HOLES AT DEPTHS OF APPROXIMATELY 100
FT. HAVE BEEN ASSUMED.

APPROXIMATE 147 GAL OF WATER IN THE LOOP WITH 2 GALLONS ADDED FOR EQUIPMENT

TO DETERMINE CIRCULATION PUMP SIZE SEE SECTION V MANUAL 2100-099

TO DETERMINE NEED OF ANTI-FREEZE SEE SECTION VI MANUAL 2100-099
FOR 18F. FREEZE PROTECTION 32 GALLONS OF PROPLYENE GLYCOL OR 245
LBS OF CALCIUM CHORIDE IS REQRUED.

DESIGN ON THIS PAGE IS APPLICABLE ONLY TO BARD HEAT PUMPS.
THIS INFORMATION IS BASED ON THE LATEST THEORIES AND PERFORMANCE DATA AVAILABLE
AND IS SUBJECT TO CHANGE WITHOUT NOTICE AS ADVANCES IN TECHNOLOGY ARE MADE.

EARTH COUPLED LOOP SYSTEM DESIGN

1. Return Design to: _____ Attn: _____
Address _____ Telephone _____
City and State _____ Zip _____
Job or Contractor (Name or Number): _____
Location of Job _____
(City) (State) (Zip)
2. Geographical location of installation (near): (See Table 2 back of this sheet)

(City) (State) (Zip)
3. Building or zone design: Cooling load: _____ Btu/Hour
Heating load: _____ Btu/Hour
Note: For buildings too large for one heat pump, complete work sheet for each zone)
4. Local ground well water temperature: _____ F°
5. Model of Bard Water Source Heat Pump to be used: _____
6. Type of System: Vertical Loop [] Horizontal Loop [] Type of Antifreeze to be used:
None [] Calcium Chloride [] Propylene Glycol []
7. Water Flow Thru Loop System: Series [] Parallel []
8. Type of pipe to be used: _____ Pipe Nominal Size _____ In.
(See Table 1 back of the sheet)
9. Number of layers of pipe in trench or loops in bore hole: _____
10. For horizontal loop systems describe and type of local soil at depth 1 to 6 foot depth during the late summer.
 - [] a. DRY-LIGHT SOIL (SAND OR GRAVEL) -
grass and weeds turn brown in summer
 - [] b. DAMP-LIGHT SOIL (SAND OR GRAVEL) -
grass turns brown, weeds stay green
 - [] c. DRY-HEAVY SOIL (CLAY)
grass turns brown, weeds stay green
 - [] d. DAMP-HEAVY SOIL (CLAY) -
Grass and weeds stay green all summer
 - [] e. WET-SOIL -
swamp, marsh bottoms, etc.

Send to: Earth Coupled Loop System Design
Bard Manufacturing Company
P.O. Box 607
Bryan, Ohio 43506

Pipe Material Description		Nominal Size
PE		
1	SDR-11	3/4
2	SDR-11	1
3	SDR-11	1-1/4
4	SDR-11	1-1/2
5	SDR-11	2
6	SCH 40	3/4
7	SCH 40	1
8	SCH 40	1-1/4
9	SCH 40	1-1/2
10	SCH 40	2
PB		
11	SDR-17, IPS	1-1/2
12	SDR-17, IPS	2
13	SDR-13.5, Cts	1
14	SDR-13.5, Cts	1-1/4
15	SDR-13.5, Cts	1-1/2
16	SDR-13.5, Cts	2

TABLE 1. Recommended Earthloop Pipes

Note: PE are polyethylene pipes
PB are polybutylene pipes

TABLE 2. Geographical Locations of Input Data.

AL	Birmingham Montgomery	IA	Des Moines Sioux	NV	Ely Las Vegas Winnemucca	PA	Middletown Philadelphia Pittsburg Wilkes-Barre	WI	Green Bay Madison
AZ	Phoenix Tucson	KS	Dodge City Topeka	NJ	Trenton	SC	Charleston Greenville Sumpter	WY	Casper Cheyene Lander Sheridan
AR	Little Rock	KY	Louisville	CA	Los Angeles Merced San Diego	LA	Lake Charles New Orleans Shreveport	NM	Albuquerque Roswell
CO	Colo. Springs Denver Grand Junc.	MA	Portland	NY	Albany Binghamton Niagara Falls Syracuse	SD	Huron Rapid City	TN	Bristol Knoxville Memphis Nashville
DC	Washington	MI	Battle Creek Detroit Sau St Marie	NC	New Bern Greensboro	TX	El Paso Ft. Worth Houston San Antonio	ND	Bismarck Grand Forks Williston
FL	Appalachicola Jacksonville	MN	Duluth Int. Falls Minneapolis	OH	Akron Columbus Dayton Toledo	UT	Salt Lake City	VT	Burlington
GA	Atlanta Augusta Macon	MS	Biloxi Columbus Jackson	OK	Altus Oklahoma City Tulsa	VA	Norfolk Richmond Ronoke	WA	Moses Lake Seattle Spokane
ID	Boise Idaho Falls	MO	Columbia Kansas City Springfield	OR	Astoria Meford Portland	WV	Charleston Elkins		
IL	Chicago E. St. Louis Urbana	MT	Billings Great Falls Missoula						
IN	Fort Wayne Indianapolis South Bend	NB	Grand Island Lincoln North Platte						