

EARTH COUPLED LOOP SYSTEM DESIGN MANUAL (GROUND SOURCE GS SYSTEM)

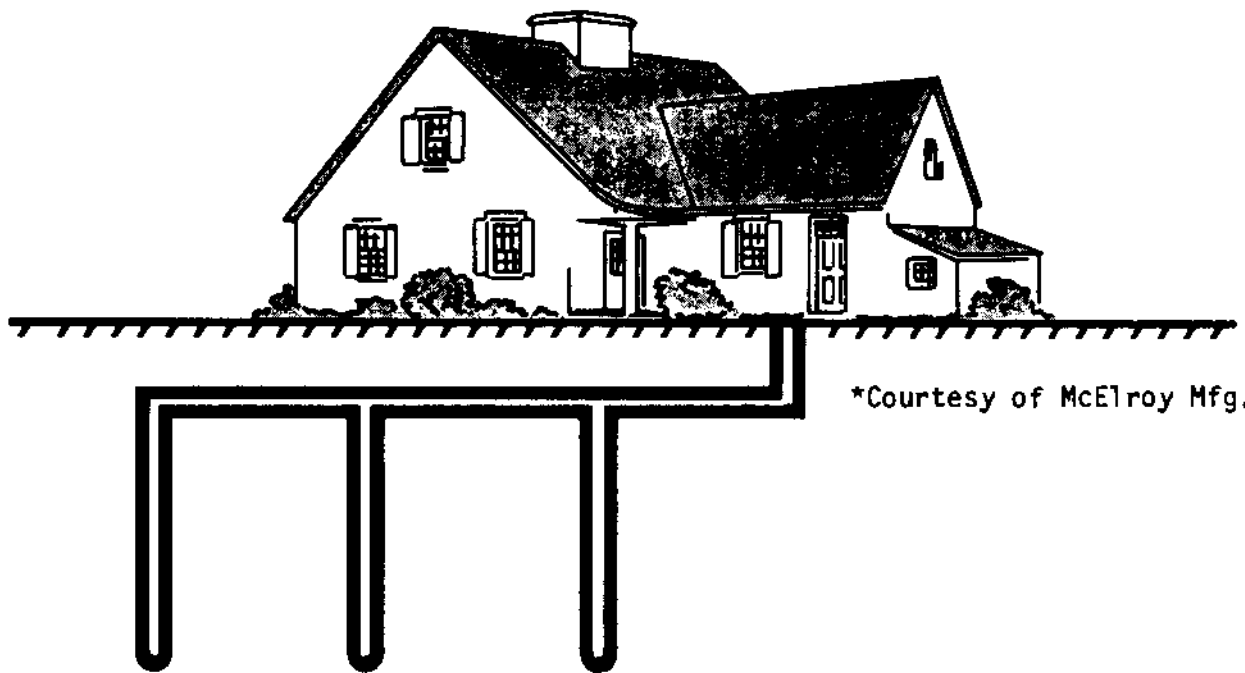

*Courtesy of McElroy Mfg.

MANUAL 2100-099 REV. L
SUPERSEDES REV. K
FILE VOL. I, TAB 1

TABLE OF CONTENTS

I.	Determine The Structure Design Heating In BTUH Loss And Design Cooling Load In BTUH Gain.	2
II.	Select A Water Source Heat Pump	2
III.	Selection Of Type Earth Coil And Materials To Be Used	2
	1. Heat Pump	3
	2. Pipe	3
	3. Cleanliness	3
	4. Pressure Testing	3
	5. Backfill	3
	6. Location Markers	3
	7. As-Built Plans	4
	8. Vertical	4
	9. Series U-Bend	4
	10. Pipe	4
	11. Stiffener	4
	12. Fill And Pressure Test	5
	13. Multiple Wells	5
	14. Service Lines	5
	15. Parallel U-Bend	5
	16. Pipe	5
	17. Horizontal	9
	18. Narrow Trenches	11
	19. Backhoe Trenches	12
	20. Service Lines or Headers.	12
	21. Headering Up	13
	22. Pipe Joining Methods	20
IV.	Design Of Earth Coil	21
	1. Soil Identification	26
V.	Installation Of The Earth Coupled Ground Heat Exchanger	28
	1. Site Plan	28
	2. Installation Equipment	28
	3. Pipe Installation Considerations	31
VI.	The Circulation System Design	35
	1. Heat Pump Connections	36
	2. Piping Connections	36
	3. Pressure Drop Calculations To Select Circulation Pump	41
	4. Standardized Parallel System Header Design	44
VII.	Freeze Protection	48
	1. Criteria For Antifreeze	48
	2. Advantages and Disadvantages of Each Circulation Fluid.	48
	3. The Most Commonly Used Antifreeze Materials	51
	A. Propylene Glycol.	51
	B. Noburst (Propylene Glycol Heater Transfer Fluid)	52
	1. Product Description	52
	2. Recommended Concentrations	53
	3. Maintenance	54
	C. Methyl Alcohol (Methanol)	54
	D. Potassium Acetate (Chevron GS4)	54
	1. Environmental Impacts	55
	2. Corrosion Properties	55
	3. Handling, Storage, and Disposal	55
	4. Adjustments of Fluid Composition	55

VIII.	System Start Up	57
	1. Adding Antifreeze	58
	2. Proper Planning Yields Problem-Free Ground-Source H/P System .	59
	3. Check Bore Holes	59
IX.	Other Items To Be Followed	60
X.	Closed Loop Systems Suspended In Ponds And Lakes	61
	1. Lake Exchanger Construction--Plastic	61
	2. Calculating Head Loss	61
	3. Placement	61
	4. Service Lines	61
	5. Antifreeze.	62
	Acknowledgements	63
	Wiring Diagram	64

FIGURES AND TABLES

Figure 1	Vertical (Series) System	6
Figure 2	Vertical (Parallel) System	7
Figure 3	Series and Parallel Horizontal Systems	8
Figure 3A	Series and Parallel Vertical Systems	8
Figure 4	Pipe Depths.	9
Figure 5	Single and Stacked Horizontal Earth Coils.	9
Figure 6	Two Pipe and Four Pipe Earth Coil In A Wide Trench	10
Figure 7	Horizontal Earth Coil Turnarounds Narrow Trench Return Bend.	10
Figure 8	Ground Heat Exchanger Building Stub Out.	11
Figure 9	Minimum Pipes In a Horizontal Trench	12
Figure 10A	Header Configuration Option.	13
Figure 10B	13
Figure 10C	Spaced Header With Reverse Return.	13
Figure 11A	Header Connections	15
Figure 11B	Trenching Configuration.	15
Figure 11C	Header Hookup (Radical Spacing) and (Single Side).	15
Figure 12	Horizontal (Series) System One-Pipe In Trench.	16
Figure 13	Horizontal (Series) System Two-Pipes In Same Trench.	17
Figure 14	Horizontal Multi-Level (Parallel) System	18
Figure 15	Socket Fusion.	19
Figure 16	Butt Fusion.	19
Figure 17	Sidewall Fusion.	19
Figure 18	Soil Temperature Swing	24
Figure 19	Comparison of Tm At Varying Depths For Different Soils	24
Figure 20	Horizontal Earth Coil Temperature Variations	24
Figure 21	Location Description of Underground Utilities.	29
Figure 22	Four Basic Installation Techniques	29
Figure 22A	Grout Pipe Method With Pump.	34
Figure 23	Closed Loop Equipment Room Piping.	35
Figure 24	37
Figure 25	37
Figure 26	37
Figure 27A	Performance Curve--Model GPM-1--Loop Pump Module	38
Figure 27B	Performance Curve--Model GPM-2--Loop Pump Module	38
Figure 27	Pump Module Hookup	39
Figure 28	Pressure and Temperature Sensing Adapter and Components.	39
Figure 29	Layout and Details of a Typical CL/GS Heat Pump System	40
Figure 30	Multiple Unit Installation	40
Figure 31A	3-Ton Header Design for Polyethylene or Polybutylene	46
Figure 31B	10-Ton Header System--PE Pipe--Butt Fused.	46
Figure 32	Freezing Point Curve--By Volume.	56
Figure 33	Portable Rig for Flushing Earth Coupled Systems.	58
Figure 34	Vertical System (Pond Loop System)	62
Figure 35	Plastic Closed Loop Lake Exchanger	62
Table 1	Soil Thermal Properties.	27
Table 1A	Field Identification of Inorganic Soil Texture	27
Table 2	Water Coil Pressure Drop	42
Table 3	Minimum Flow In Pipe For Turbulance (GPM).	42
Table 4	Selection of Circulation Pump or Pumps	42
Table 5	Piping Feet of Head Loss At Different Flow Rates per 100 Feet.	42
Table 5A	Required Heat Exchanger Components	47
Table 6	Pipe Material.	51
Table 7	Flow Rate (GPM) Required for Debris Flushing and Air Purging	57

IMPORTANT

The following Bard Water Source Heat Pumps will not work on earth loop systems.

WPV30 or WPVD30
WPV36 or WPVD36
WPV53 or WPVD53
WPV62 or WPVD62
WQS30 or WQSD30
WQS36 or WQSD36
WQS50 or WQSD50

For EARTH LOOP SYSTEMS use one of the following:

WPV24
WPV30A or WPVD36A
WPV36A or WPVD36A
WPV53A or WPVD53A
WPV62A or WPVD62A
HWP30 or HWPD30
HWP36 or HWPD36
WPV30B
WPV36B
WPV53B
WPV62B
WQS30A
WQS36A
WQS42A

The design of an earth coupled system is divided up into the following steps.

I. DETERMINE THE STRUCTURE DESIGN HEATING IN BTUH LOSS AND DESIGN COOLING LOAD IN BTUH GAIN

It is very important that an accurate load calculation of the structure be done, therefore, it is recommended that "Manual J" from ACCA or other national accepted methods be used.

II. SELECT A WATER SOURCE HEAT PUMP

When selecting a water source heat pump for use on an earth coupled system, it may have to operate at entering water temperatures between 25°F to 100°F, therefore, it is very important that the minimum and maximum entering water temperatures of the selected water source be within that range. Several models on the market today have a much smaller operating range such as 45° to 85° or 60° to 85° entering water temperature. Some of those will not provide satisfactory operation on an earth coupled installation.

The heating or cooling capacity of the water source heat pump should be determined from the manufacturer's specifications for the design minimum and maximum loop water temperatures. The water source heat pump should be sized as follows:

HEAT PUMPS SIZED FOR COOLING--The output capacity of cooling equipment should not be less than 100% calculated total load nor should it exceed the calculated load by more than 150%. The corresponding latent capacity should not be less than the calculated total latent load. The equipment sensible and latent capacities should be determined from the manufacturer's cataloged performance data. Catalog performance should be verified at the design maximum loop water temperature and indoor design conditions expected on a design day.

HEAT PUMPS SIZED FOR HEATING should not be less than 60% nor more than 115% of the calculated total heating load. Catalog performance should be verified at the design minimum loop water temperature and indoor design conditions expected on a design day. (Auxiliary heat should be sized to make up for any deficiency in output when the heat pump unit is undersized.) Emergency heat may be required in some locations.

HEAT PUMPS FOR HEATING AND COOLING shall be sized to meet 100% to 150% of the design cooling load depending on heating size requirements and allowable indoor temperature swings--units that meet 60% to 90% of the design heating load are generally adequate when allowances for internal and solar gains are considered. Auxiliary heat should be sized to make up for the difference between the design heating load and the heat pump output on a design day. Emergency heat may also be required in some locations. Contact Bard Technical Service for application assistance.

III. SELECTION OF TYPE EARTH COIL AND MATERIALS TO BE USED

EARTH COUPLED SYSTEMS--Earth coupling is a method by which water used by the heat pump is circulated through pipes buried in the ground. Heat is transferred to and from the soil through the walls of the pipe. Earth coupled systems are used in areas where insufficient ground water is available or where it is impractical to drill a well. The piping may be buried in either a vertical or a horizontal configuration.

When designing an earth coupled system, particular attention must be paid to balancing the system between the heat pump unit and the earth coupled loop. In a balanced system, the earth coupled loop will remove all of the heat energy transferred to the water by the heat pump (cooling cycle) and will provide all of the heat energy to the water that the heat pump unit is capable of absorbing (heating cycle). The net result of a perfectly balanced system is that the change in water temperature through the heat pump is offset by an equal and opposite change in temperature through the earth coupled loop. For instance, if the heat pump unit in the cooling cycle causes the water temperature to rise 15°F, then the loop must cause a corresponding drop of 15°F.

A word of caution is required here. Although the earth coupled loop is designed for a balanced rise and fall in water temperature suggesting that the net average loop water temperature remains constant because the ground temperature may vary $\pm 15^{\circ}\text{F}$ from season to season, the loop water temperature may vary $\pm 20^{\circ}\text{F}$ from the balance point temperature. This is because the ground is able to overcool the loop water in winter, and may undercool in summer. Because of this, the temperature of the water entering the water source heat pump unit may drop below 30°F in winter or rise above 100°F in summer. This range in entering water temperature is extremely important because water source heat pumps are designed to operate within specific operating temperature ranges (see manufacturer's specifications for water source heat pump operating ranges). The temperature ranges are established to protect both the heat pump unit and the water loop piping. Furthermore, these temperature ranges are based on water only passing through the system. The low temperature limit of 40°F in a water source heat pump unit is established to protect the loop water from freezing. Again, this low limit presumes that water only flows through the system. However, if the water is mixed with a non-toxic antifreeze solution, the entering water temperature can be allowed to fall to 25°F .

HEAT PUMP

Use only a water source heat pump that can be operated on loop temperatures well below 40°F down to 25°F . Information on when to use an antifreeze solution in a ground coupled water source heat pump system is contained in the following discussions on vertical and horizontal configurations.

PIPE

Use polybutylene (PB) or polyethylene (PE) pipe for horizontal coils, vertical U-bend wells and for service lines to the wells and lake exchangers. PB pipe is fused together with appropriate fittings using a fusion tool. PE pipe is heat butt or socket fused with appropriate fittings using a fusion tool.

CLEANLINESS

During installation, keep trash, soil, and small animals out of the pipe. Leave the ends of the earth loop pipe taped until the pipe is ready to be connected to the service lines of the equipment room piping.

PRESSURE TESTING

Plastic pipe assemblies should be pressure tested at twice the anticipated system operating pressure prior to backfilling. Normal static equipment room pressure is 50 psig.

BACKFILL

Narrow trenches made with a chain trencher can be backfilled with the tailings provided no sharp rocks are present.

Wider backhoed trenches can be backfilled with the excavated material provided it is in loose granular form. If the material contains clumps of clay or rocks, the plastic pipe must be covered first with sand before filling in with clumps and rocks.

Drilled boreholes of 4 - 6 inches in diameter are common for vertical geothermal wells. Backfill may be any granular material not containing sharp rocks. This includes the drilling tailings, sand, pea gravel or bentonite mud.

LOCATION MARKERS

It is desirable that the locations of important points such as well heads be marked for subsequent recovery. The placement of a steel rod just below the surface can identify these features or mark the outline of an entire serpentine earth coil.

AS-BUILT PLANS

Earth coupling features should be drawn on a site plan as installed, if possible, to aid in the location of key components. A simple way to locate key features is to make 2 measurements (sides of a triangle) from 2 corners of a building to the feature. Record these measurements in a table on the plans. (See Figure 21)

Reasons for using an earth coupled system.

1. Unlike a standard solar system, the loop operates day or night, rain or shine all year, delivering heat to and from the heat pump.
2. It is cost effective in northern or southern climates.
3. Because the water circulates through a sealed closed-loop of high strength plastic pipe, it eliminates scaling, corrosion, water shortage, pollution, waste and disposal problems possible in some open well water systems.

VERTICAL

A vertical earth coupled system consists of one or more vertical boreholes through which water flows in plastic pipe. A distinct advantage of vertical system over a horizontal system is that the vertical system requires less surface area (acreage). In areas where the ambient groundwater (average well water) temperature is less than 60°F, the use of an antifreeze solution to avoid freezing the loop is recommended. (Figures 1, 2, and 3)

Boreholes are drilled 5 inch to 6 inch in diameter for 1-1/2 inch diameter pipe. For 3/4 inch diameter pipe loop systems, the vertical loops are connected in parallel to a 1-1/2 inch diameter pipe header. A borehole of 3 inch to 4 inch in diameter is used for 3/4 inch diameter loops, this lowers drilling costs. The 3/4 inch diameter pipe also costs less per ton of heat pump capacity. The smaller pipe is easier to handle, yet there is no sacrifice in pressure rating. Also two loops in one hole reduces borehole length. Depth for these systems is usually between 80 and 180 feet.

The basic components of a vertical earth coupled system are detailed in Figure 1. Each borehole contains a double length of pipe with a U-bend fitting at the bottom. Multiple boreholes may be joined in series or in parallel. Sand or gravel packing is required around the piping to assure heat transfer. In addition, the bore around the pipes and immediately below the service (connecting) lines must be cemented closed to prevent surface water contamination of an aquifer in accordance with local health department regulations.

SERIES U-BEND

A series U-bend well earth coupling is one in which all the water flows through all of the pipe progressively traveling down and then up each well bore. Series wells need not be of equal length.

PIPE

1-1/2 inch polybutylene or polyethylene pipe is commonly used in 5 to 6 inch boreholes.

PB pipe is heat fused together with fittings. PE pipe is heat fused together with butt or fitting joints.

STIFFENER

Tap the last 10 to 15 feet of pipe above the U-bend together to a rigid piece of pipe or conduit. This will make installing the pipe into the well easier.

FILL AND PRESSURE TEST

Fill with water and pressure test before lowering the U-bend into a well bore. When drilling with air, a bore can be completed that contains no water. If unfilled plastic pipe is lowered into the bore, it will be crushed as the hole slowly fills.

MULTIPLE WELLS

Multiple 100 foot wells connected in series are the easiest to drill and install in most areas. It will be difficult to sink water filled plastic U-bends into mud filled holes over 150 feet deep without weights. Wells are generally spaced 10 feet apart in residential systems. The well should not be less than 50 feet deep.

SERVICE LINES

Follow the guidelines for the horizontal earth coil when installing the service lines to and from the U-bend well.

PARALLEL U-BEND

A parallel U-bend well earth coupling is one in which the water flows out through one header, is divided equally, and flows simultaneously down two or more U-bends. It then returns to the other header. Headers are reverse return plumbed so that equal length U-bends have equal flow rates. Lengths of individual parallel U-bends must be within 10% of each other to insure equal flow in each well.

PIPE

1-1/2 inch polybutylene or polyethylene pipe is used for the headers with 1 inch or 3/4 inch pipe used for the U-bends. 4 inch bore holes are sufficient for placement of 1 inch U-bends.

Follow "Series U-Bend Well" instructions on:

Stiffener
Fill and Pressure Test

Multiple Wells
Service Lines

RULE OF THUMB		
MINIMUM DIAMETERS FOR BOREHOLES		
Nominal Pipe Size	Single U-Bend	Double U-Bend
3/4"	3-1/4"	4-1/2"
1"	3-1/2"	5-1/2"
1-1/4"	4"	5-3/4"
1-1/2"	4-3/4"	6"
2"	6"	7"

RULE OF THUMB
For parallel systems, use one loop for each one ton (12,000 Btuh) of heat pump capacity. For example, a three ton heat pump would have three parallel loops. Headers are constructed from 3/4 and 1 inch pipe. For heat pumps with reduced flow requirements (2 GPM/ton and less), the series system should be considered in order to maintain the necessary fluid velocities to promote good heat transfer. See Table 3.

RULE OF THUMB
PVC pipe is not recommended for the buried portion of the earth coupled ground heat exchanger.

FIGURE 1
VERTICAL (SERIES) SYSTEM

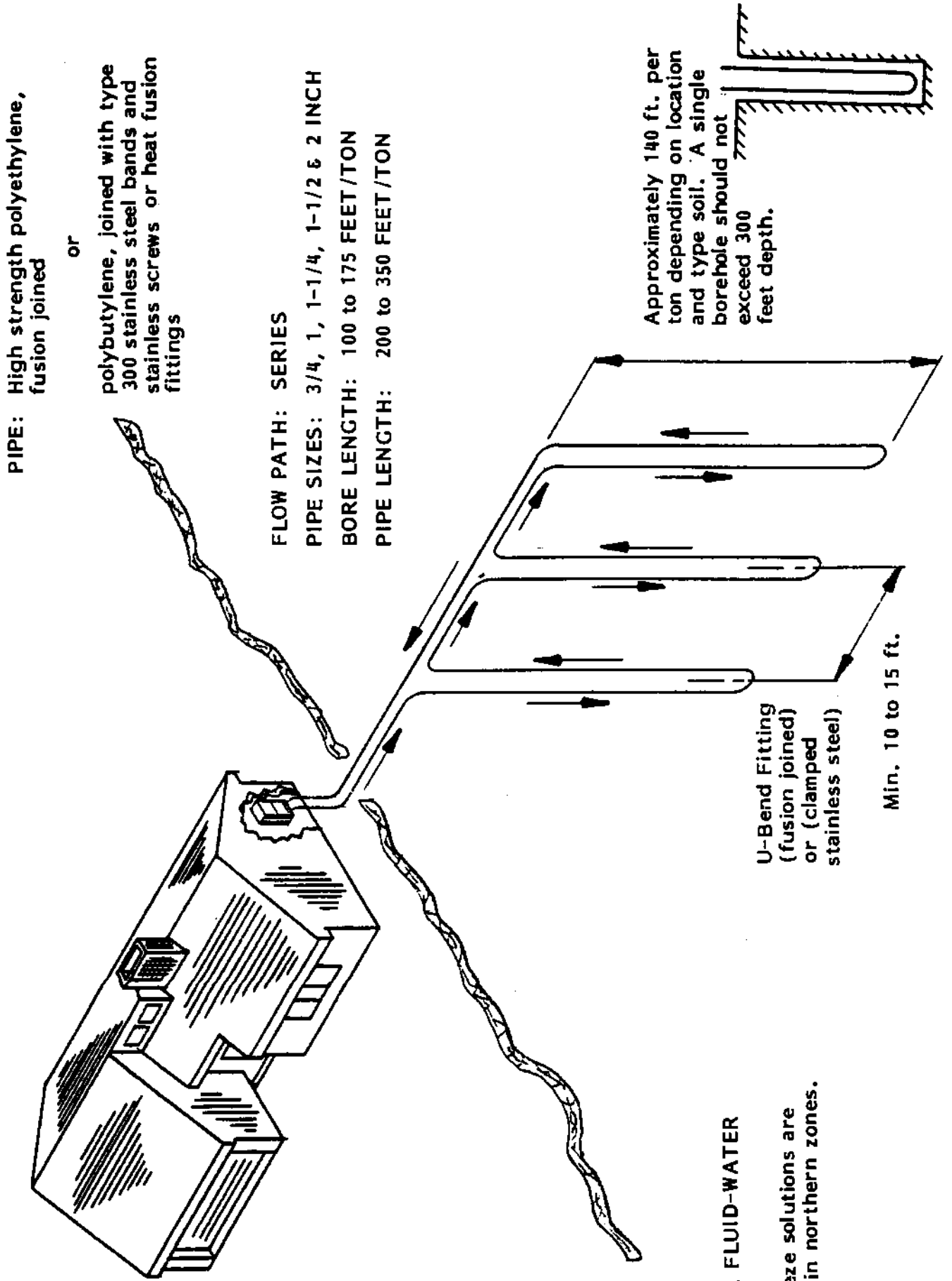

PIPE: High strength polyethylene,
fusion joined

or

polybutylene, joined with type
300 stainless steel bands and
stainless screws or heat fusion
fittings

FLOW PATH: SERIES

PIPE SIZES: 3/4, 1, 1-1/4, 1-1/2 & 2 INCH

BORE LENGTH: 100 to 175 FEET/TON

PIPE LENGTH: 200 to 350 FEET/TON

Approximately 140 ft. per
ton depending on location
and type soil. A single
borehole should not
exceed 300
feet depth.

U-Bend Fitting
(fusion joined)
or (clamped
stainless steel)

Min. 10 to 15 ft.

TRANSFER FLUID-WATER

NOTE:

Antifreeze solutions are
needed in northern zones.

FIGURE 2
VERTICAL (PARALLEL) SYSTEM

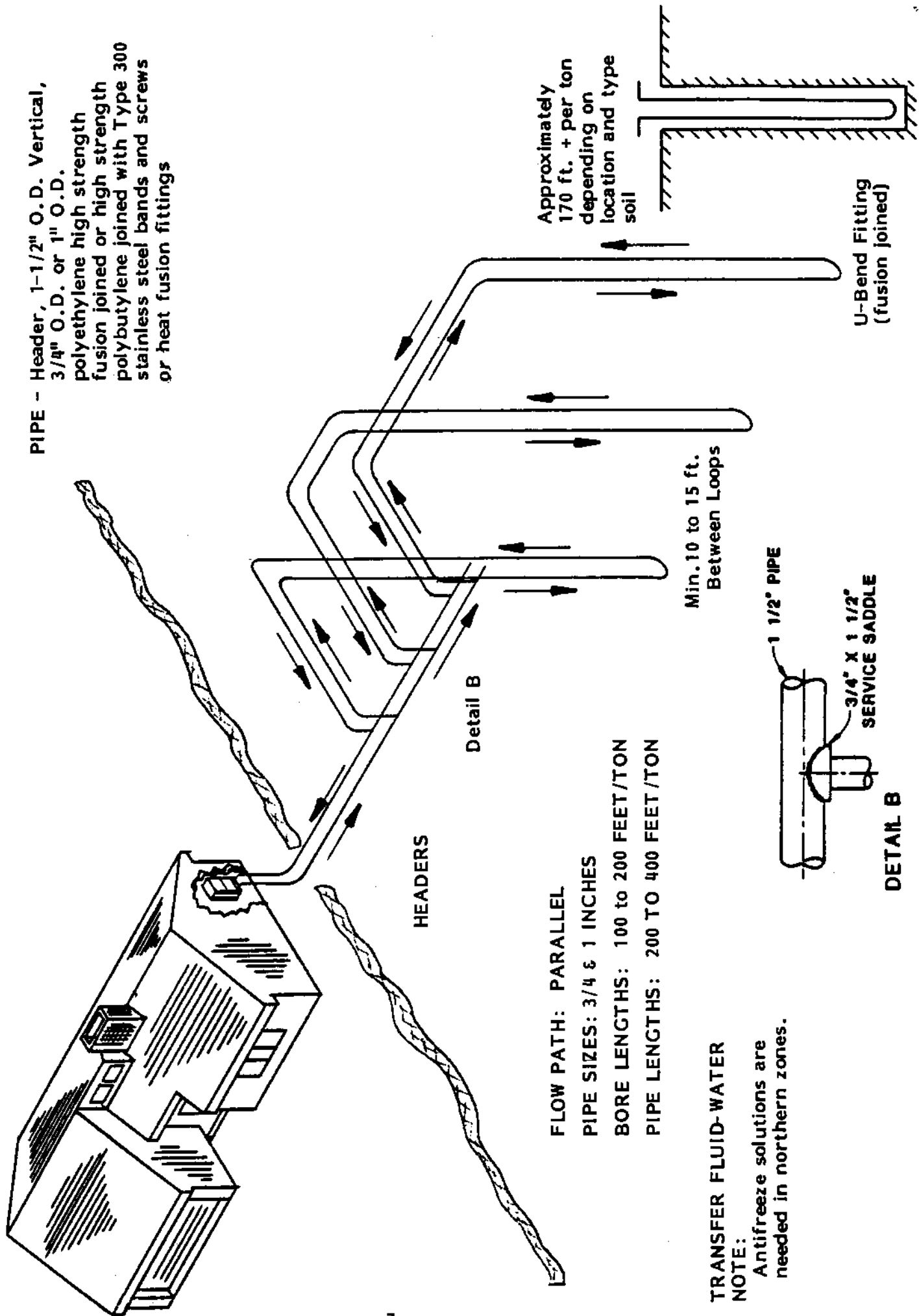

PIPE - Header, 1-1/2" O.D. Vertical, 3/4" O.D. or 1" O.D. polyethylene high strength fusion joined or high strength polybutylene joined with Type 300 stainless steel bands and screws or heat fusion fittings

FLOW PATH: PARALLEL
PIPE SIZES: 3/4 & 1 INCHES
BORE LENGTHS: 100 TO 200 FEET/TON
PIPE LENGTHS: 200 TO 400 FEET/TON

Min. 10 to 15 ft.
Between Loops

TRANSFER FLUID-WATER
NOTE:
Antifreeze solutions are needed in northern zones.

Approximately 170 ft. + per ton depending on location and type soil

U-Bend Fitting (fusion joined)

1 1/2" PIPE
3/4" X 1 1/2" SERVICE SADDLE
DETAIL B

FIGURE 3
SERIES AND PARALLEL HORIZONTAL SYSTEMS

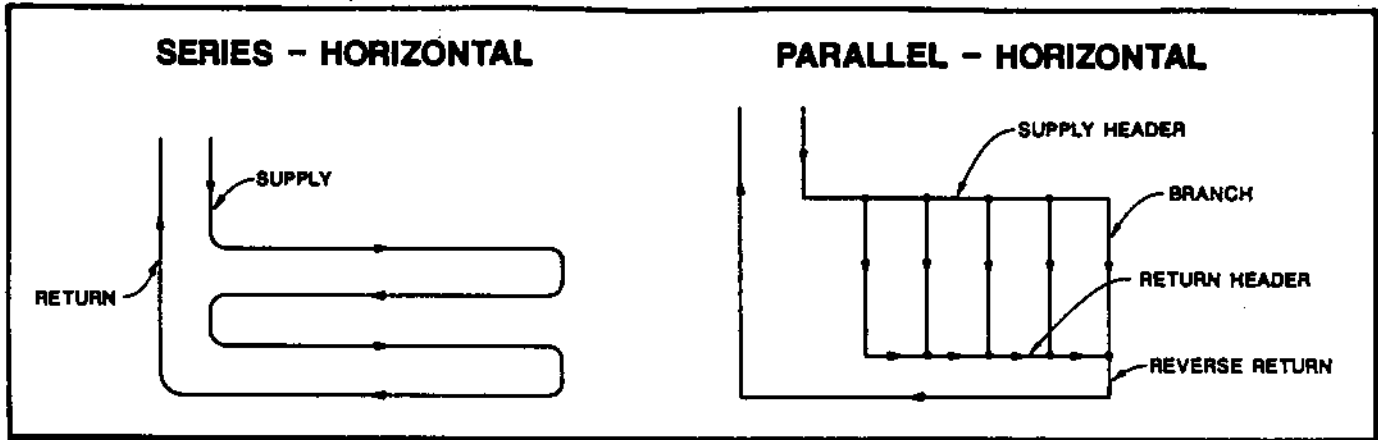
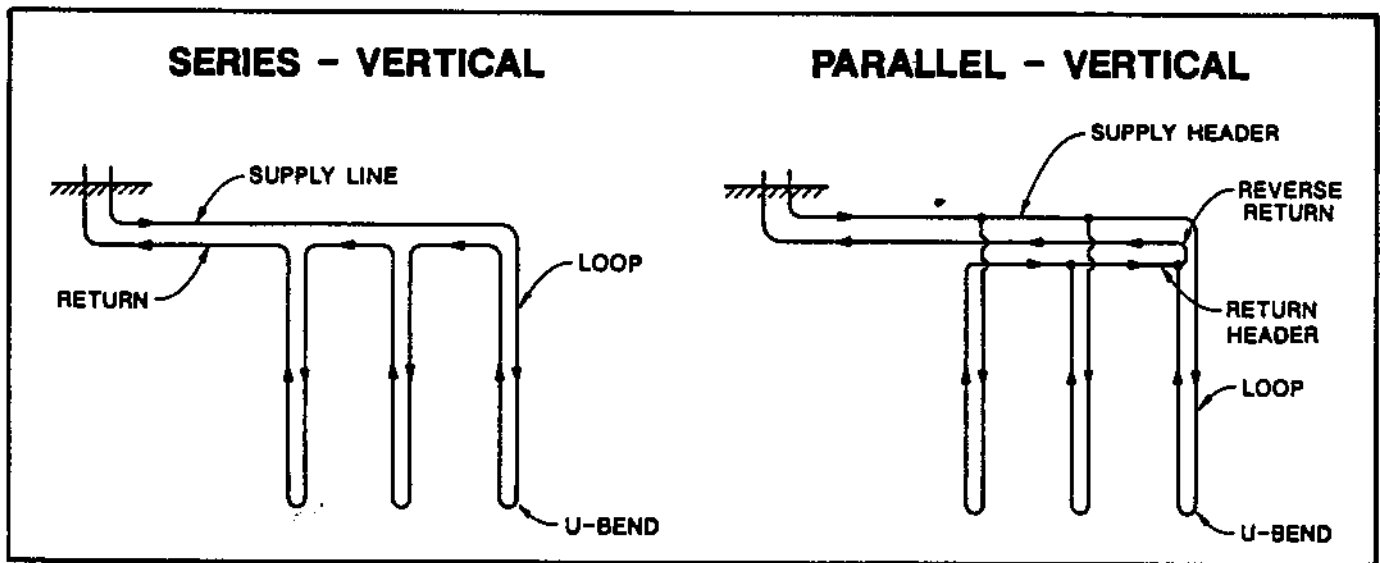

FIGURE 3A
SERIES AND PARALLEL VERTICAL SYSTEMS



SERIES SYSTEM ADVANTAGES

1. Single flow path and pipe size.
2. Slightly higher thermal performance per linear foot of pipe since larger diameter pipe is required in the series system.

SERIES SYSTEM DISADVANTAGES

1. Larger fluid volume of larger pipe in a series requiring greater antifreeze volumes if antifreeze is required.
2. Higher pipe price per unit of performance.
3. Increased installed labor cost with horizontal systems.
4. Limited capacity (length) due to fluid pressure drop characteristics.

PARALLEL SYSTEM ADVANTAGES

1. Lower cost pipe because smaller diameter.
2. Less antifreeze required.
3. Lower installation labor cost on horizontal systems.

PARALLEL SYSTEM DISADVANTAGES

1. Special attention to assure air removal.
2. Special attention required to assure equal length loops.

HORIZONTAL

A horizontal earth coupled system is similar to a vertical system in that water circulates through underground piping. However, the piping in this system is buried in a trench. (See Figures 12, 13, and 14)

Pipe depths in the Northern Zone should be 3 to 5 feet. Excessive depth will reduce the ability of the sun to recharge the heat used in winter.

Pipe depths in the Southern Zone should be 4 to 6 feet, so that the high temperature of the soil in late summer time will not seriously affect system performance.

Antifreeze will be necessary in the Northern Zone to prevent freezing of the circulated water and to allow the system to gain capacity and efficiency by using large amount of heat released when the water contained in the soil is frozen.

Antifreeze solutions used are a non-toxic Propylene Glycol or Potassium Acetate (GS4).

The use of multiple pipes in a trench reduces total trench length substantially. If a double layer of pipe is laid in the trench (Figure 5), then the two layers should be set two feet apart to minimize thermal interference. Example: A 1-1/2 inch series horizontal system with pipes at 5 feet and 3 feet. After installing first pipe at 5 foot depth, partially backfill to 3 foot depth using a depth gauge stick before installing second pipe with the return line running closest to the surface and the supply line running below it. This arrangement will maximize the overall system efficiency by providing warmer water in heating mode and colder water for cooling mode. Connect pipe ends to heat pump after the pipe temperature has stabilized so that shrinkage will not pull pipe loose.

FIGURE 4

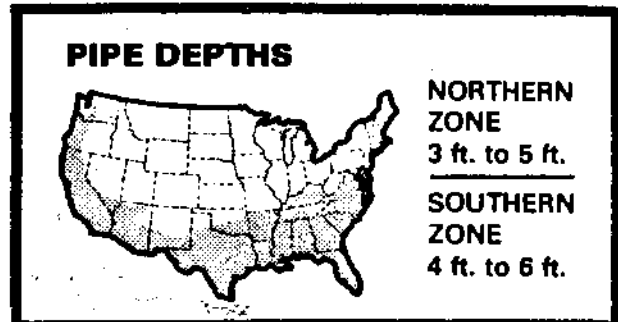

FIGURE 5
SINGLE AND STACKED HORIZONTAL EARTH COILS

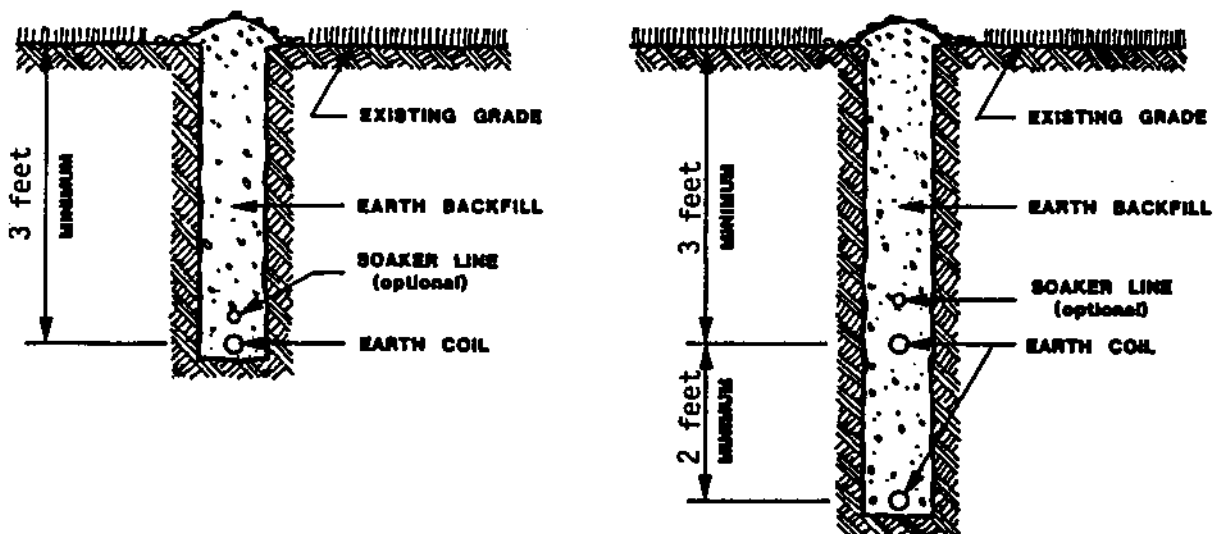
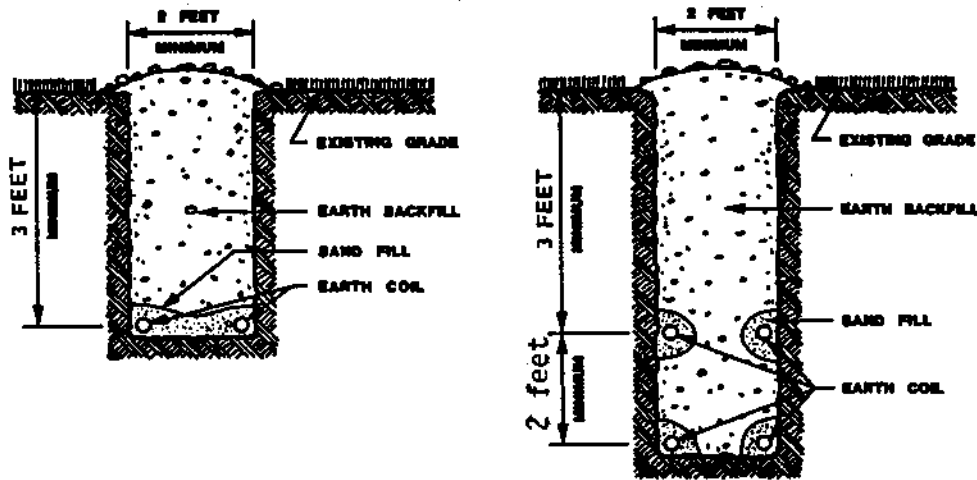

FIGURE 6
TWO PIPE AND FOUR PIPE EARTH COIL IN A WIDE TRENCH





Two pipes in the same trench, one above the other, separated by two feet of earth require a trench 60% as long as a single pipe. The total length of pipe would be 120% as long as a single pipe due to the heat transfer effect between the pipes.

In addition, when laying a double layer of pipe, be careful to avoid kinks when making the return bend (see Figure 7). Backfill the trench by hand when changing direction. If it is necessary to join two pipes together in the trench, use the fusion technique for greater strength and durability. Then mark fitting locations for future reference by inserting a steel rod just below grade. The steel rod enables the use of a metal detector to find joints in pipe.

Trenches can be located closer together if pipe in the previous trench can be tested and covered before the next trench is started. This also makes backfilling easier. Four to five feet spacing is good.

In those areas with dry climates and heavy clay soil, heat dissipated into the soil may reduce the thermal conductivity of the soil significantly. In such cases, the designer may specify additional feet of pipe per ton of capacity. A few inches of sand may also be put in with the pipe, or a drip irrigation pipe buried with the top pipe to add occasional small amounts of water.

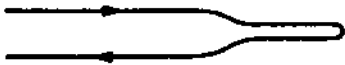
FIGURE 7
HORIZONTAL EARTH COIL TURNAROUNDS
NARROW TRENCH RETURN BEND DETAIL
DOUBLE LAYER HORIZONTAL EARTH COIL

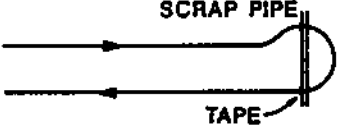
HORIZONTAL RETURN LOOP OPTIONS		
PREFABRICATED U-BEND		<ul style="list-style-type: none"> • BEST • HIGH CRUSH RESISTANCE
90° ELBOWS		<ul style="list-style-type: none"> • BETTER
LARGE RADIUS		<ul style="list-style-type: none"> • GOOD • HAND BACKFILL REQUIRED

When making the return bend, be careful not to kink the pipe. Two inch pipe requires a four foot diameter bend.

RULE OF THUMB		
Maximum recommended pipe length in series: (Pressure loss, water @ 40°F)		
Nominal Size	Description Flow, Length	Head (Feet)
3/4"	SDR-11 (0.86 inch ID) 3 GPM, 500 ft.	10.3
1"	SDR-11 (1.077 inch ID) 3 GPM, 1,500 ft. 4.5 GPM, 800 ft.	10.4 11.4
1-1/4"	SCH40 (1.380 inch ID) 7.5 GPM, 1,200 ft.	12.9
1-1/2"	SCH40 (1.61 inch ID) 9 GPM, 1,500 ft.	10.7
2"	SCH40 (2.067 inch ID) 15 GPM, 2,500 ft.	10.7

NOTE: Fluid pressure drop dictates the length of pipe run in any ground heat exchanger design.

FIGURE 8
GROUND HEAT EXCHANGER BUILDING STUB OUT

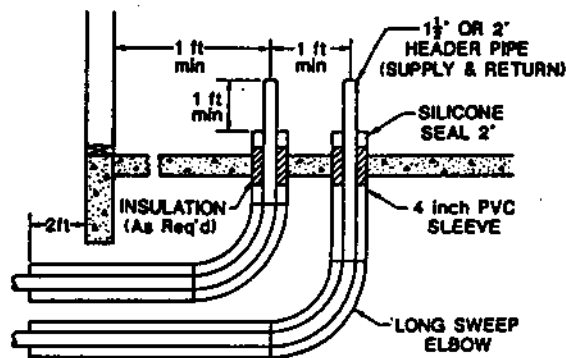

- NOTE: (1) Ground heat exchanger stub outs should be spaced a minimum of one foot from any wall or obstruction.
(2) Long sweep elbows are required for 1-1/2 inch or 2 inch header pipes.

Series horizontal earth couplings are ones in which all the water flows through all of the pipe. These may be made of 1 inch, 1-1/2 inch, and 2 inch pipe either insert coupled or fused.

NARROW TRENCHES

Narrow trenches are installed by trenching machines. The trenches are usually 6 inches wide. Generally speaking, the trencher will require about 5 feet between trenches. This is sufficient spacing for horizontal earth coils.

The pipe can be coiled into an adjoining trench. Since the trencher spaces the trenches about 5 feet apart, looping the coil from one trench to another will give a large enough diameter return. The end trench should be backhoed to give enough room for the large diameter bend.

If the pipe is brought back in the same trench, bend the pipe over carefully to avoid kinking the pipe and hand backfill the area around the return bend (Figure 7).

To reduce the bend radius, elbows may be used. However, keeping the number of fittings underground to a minimum may be preferable since the potential for leaks is reduced.

If a double layer of pipe is used, the incoming water to the heat pump should be from the deepest pipe. This provides the heat pump with the coolest water in summer and the warmest in winter.

BACKHOE TRENCHES

If a backhoe is used, the trench will probably be about 2 to 3 feet wide. In a wide backhoed trench, two or three pipes may be placed side by side, one on each side of the trench. The pipes in the trench must be at least 1.5 feet apart.

Backfill carefully around the pipe with fine soil or sand. Do not drop clumps of clay or rock onto the pipe. See Figure 7 for return loop designs.

FIGURE 9

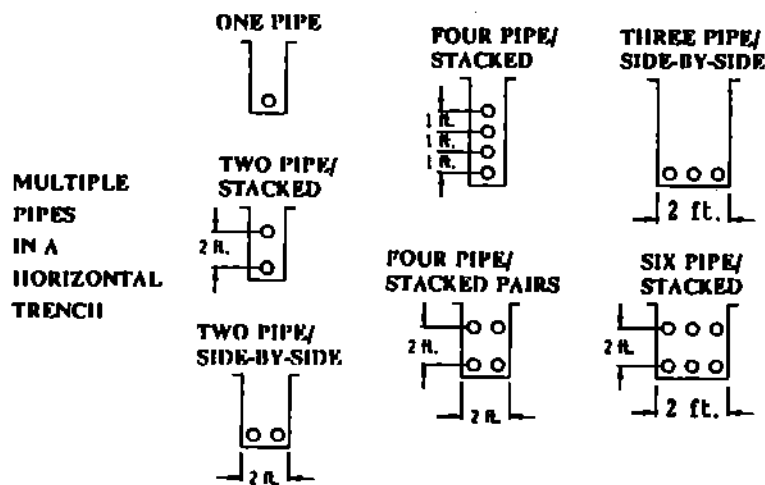

(Recommend minimum of 3 feet of soil above top pipe.)

SERVICE LINES OR HEADERS

The recommendations for the horizontal earth coils also apply for the installation of service lines to and from the U-bend wells and pond or lake exchanger.

Bury the service lines a minimum of 3 feet for single layer pipe, 3 feet and 5 feet deep for double layer pipes.

If 2 pipes are buried in the same trench, keep them 2 feet apart.

A parallel horizontal earth coupling is one in which the water flows out through a supply header, is divided equally, and flows simultaneously into 2 or more earth coils. It then returns to the other header. Headers are reverse return plumbed so that equal length earth coils must be within 10% of each other to insure equal flow in each coil. (Figures 10A thru 10C)

For further information on header design, see section on "Standardized Parallel System Header Design".

Follow "Series Horizontal Earth Coupling" instructions on NARROW TRENCHES AND BACKHOE TRENCHES.

RULE OF THUMB		
Trench length is reduced in the following proportion when multiple pipes are installed in a single trench		
Number of Pipes	Trench/Pipe (Feet)	Depths (ft)
1	500/500	5
2	300/600	4,6
4	200/800	3,4,5,6

HEADERING UP

The process of connecting loops to the header is called headering up. Consider a system of seven bore holes with drilling placement as shown in Figure 11A. The contractor has two choices:

1. Run the supply and return headers down the center of the loop field and connect as shown in Figure 11A.
2. Run the supply and return headers along a single side of the bore holes.

Either method is acceptable. Some contractors prefer to drill bore holes in a single line which reduces the location time between bore holes.

The trenching pattern or sequence connecting the loops to the bell hole is shown in Figure 11B. By placing the main header as shown in Figure 11C and using 90° elbows, pipe loops can be connected without placing undue stress on the pipe. The bell hole must be large enough for two people to work in comfortably.

For bore holes in a straight line, the axis of the service saddle can be laid horizontal and avoid the use of the 90° elbow. Header placement in this case is shown in Figure 11C.

FIGURE 10A
HEADER CONFIGURATION OPTION

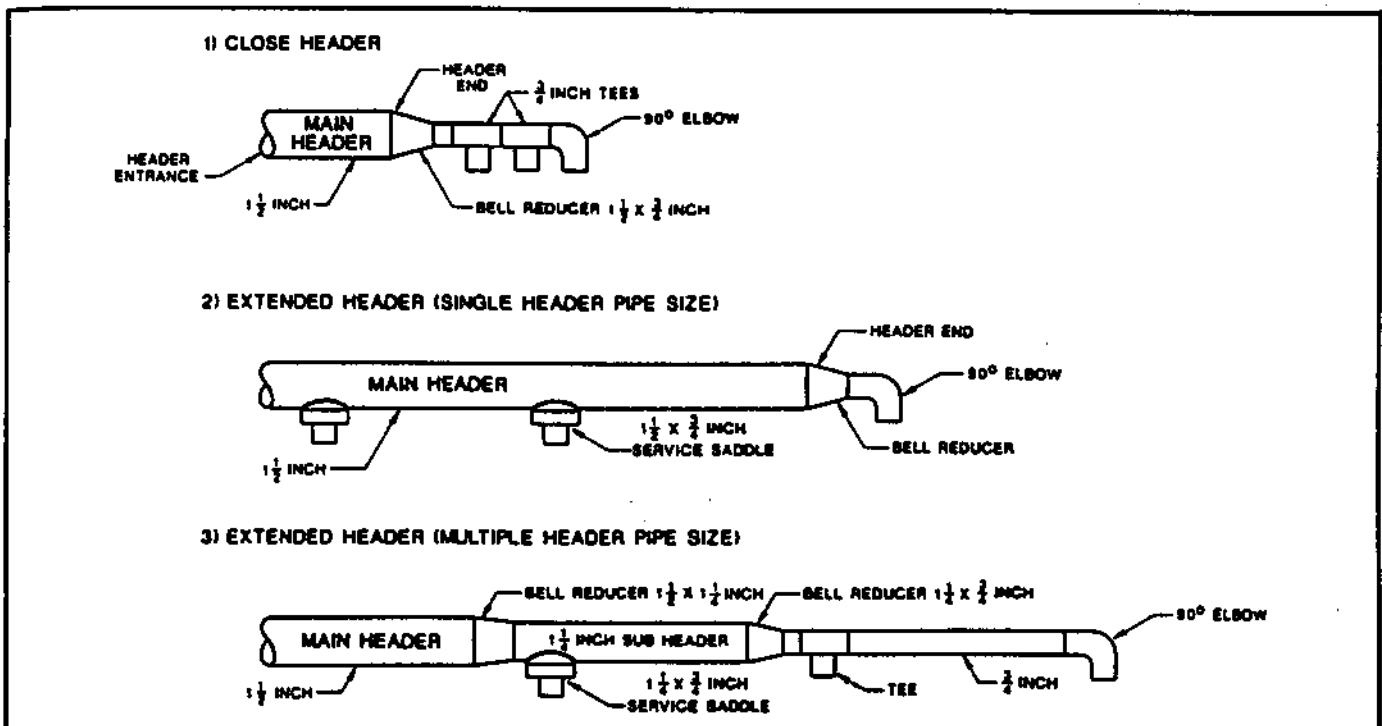

FIGURE 10B

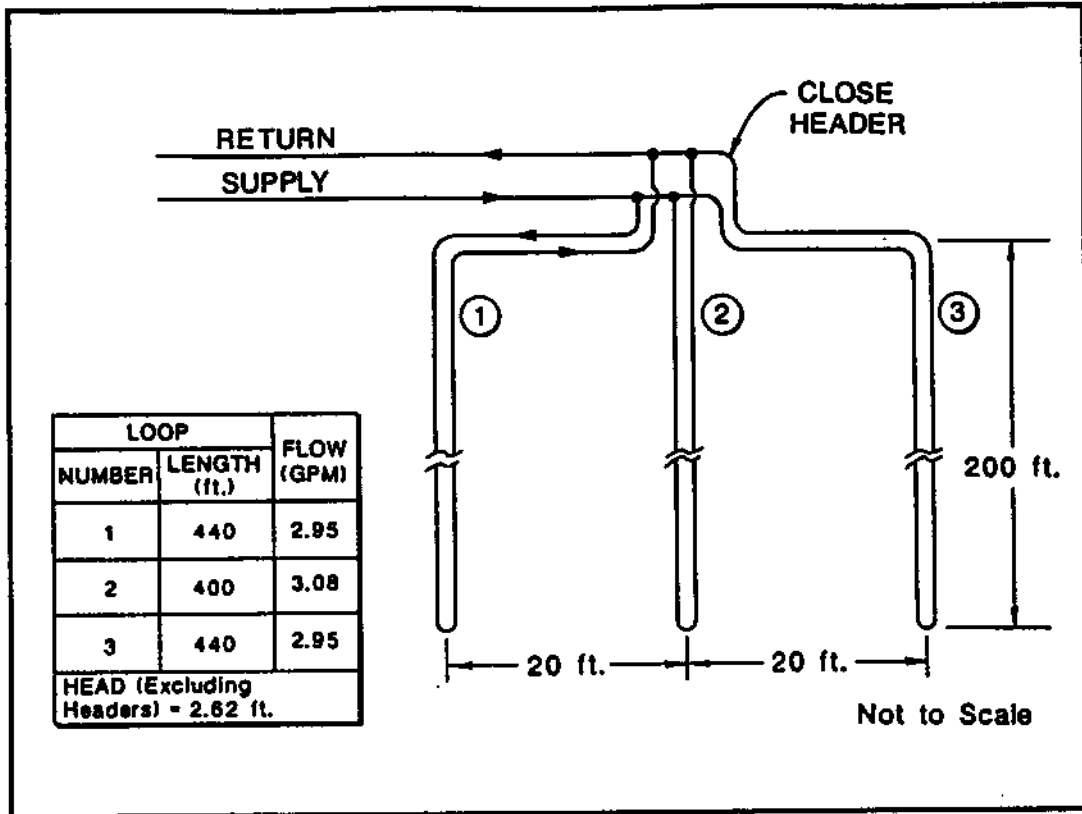
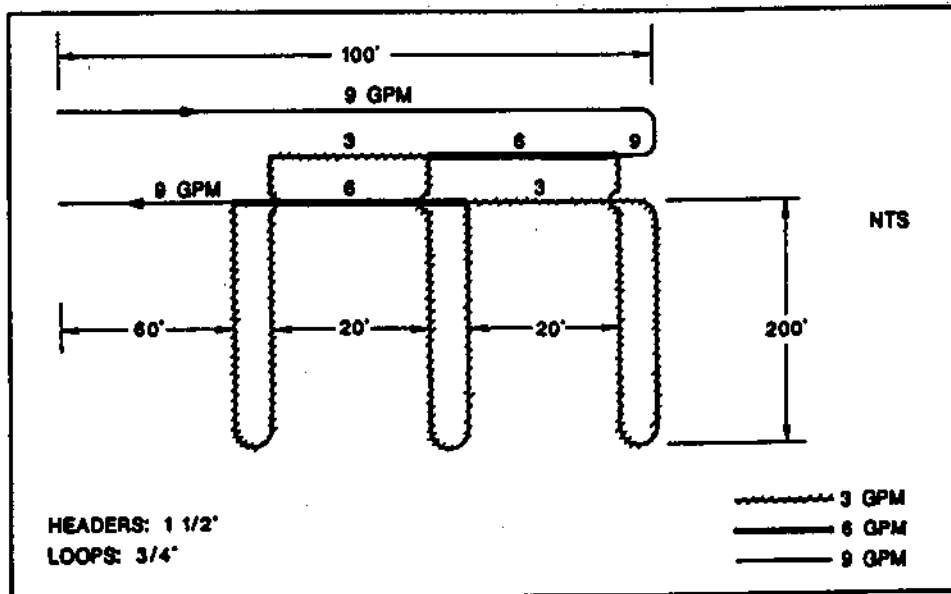
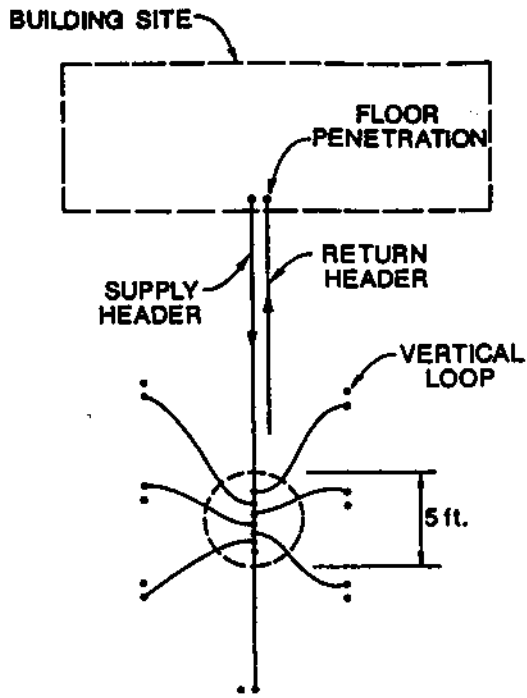

FIGURE 10C
SPACED HEADER WITH REVERSE RETURN

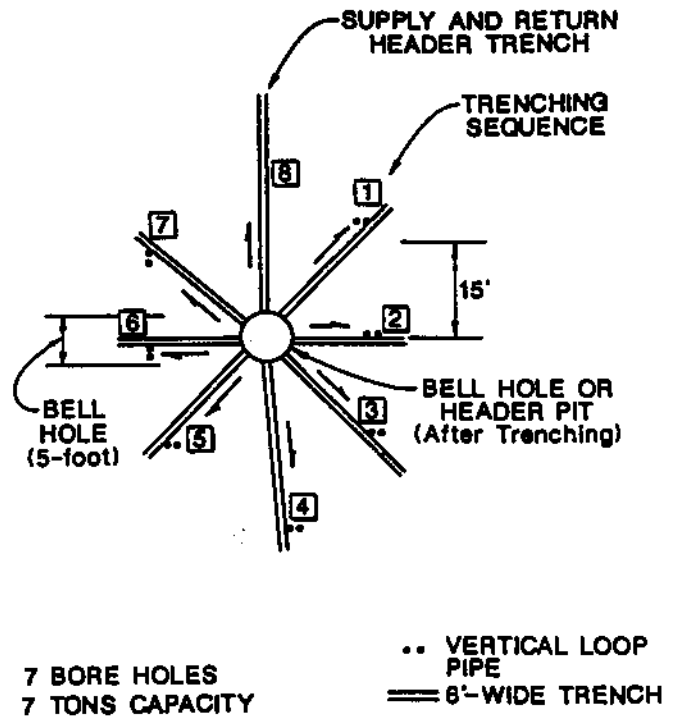

**FIGURE 11A
HEADER CONNECTIONS**



Not to Scale

**FIGURE 11B
TRENCHING CONFIGURATIONS**



**FIGURE 11C
HEADER HOOKUP**

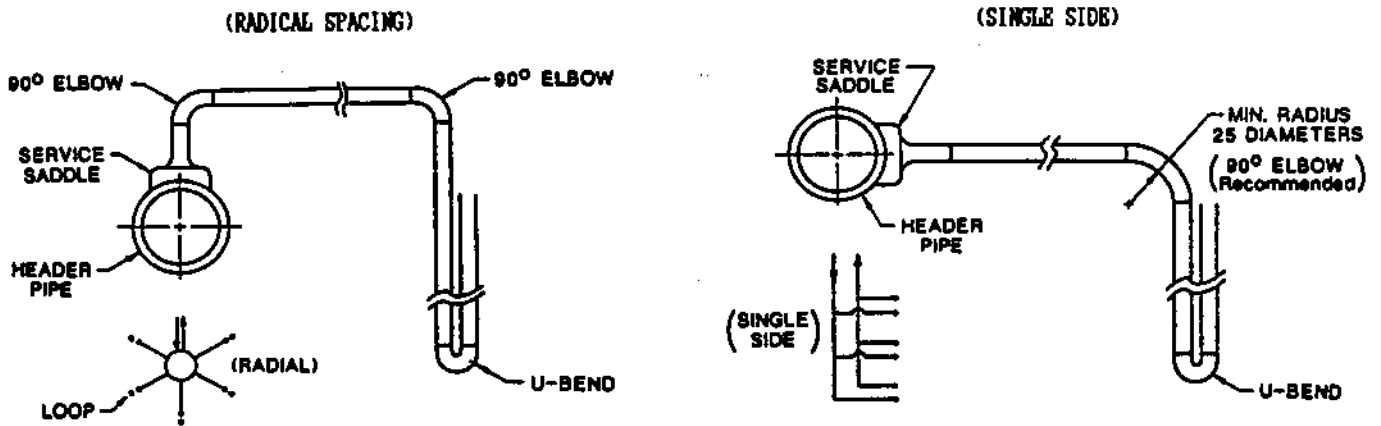
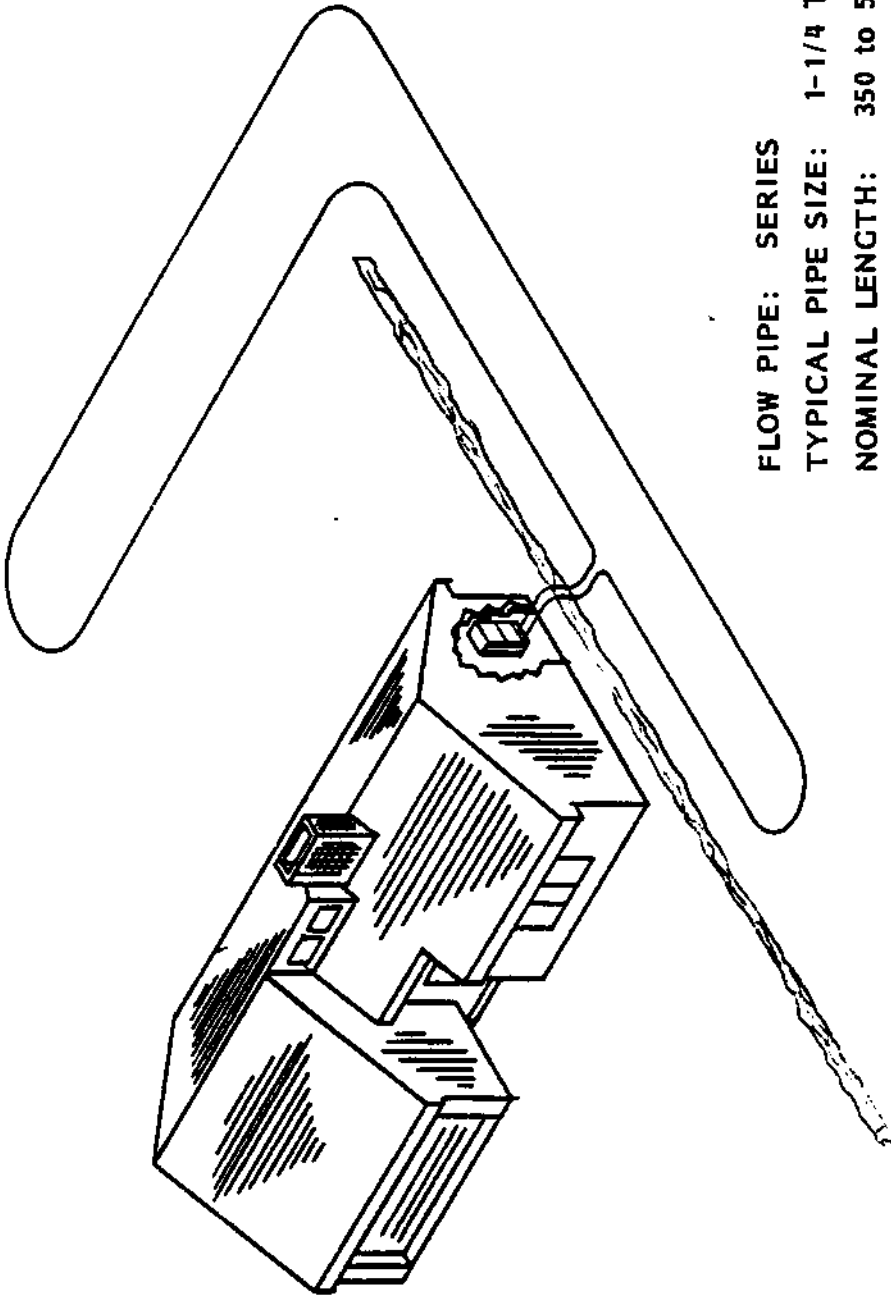

FIGURE 12
HORIZONTAL (SERIES) SYSTEM

ONE PIPE IN TRENCH



PIPE: High strength polyethylene
 fusion joined

or

polybutylene, joined with
 Type 300 stainless steel
 bands and screws or heat
 fusion fittings

- FLOW PIPE: SERIES**
- TYPICAL PIPE SIZE: 1-1/4 TO 2 INCHES**
- NOMINAL LENGTH: 350 to 500 FEET/TON**
- BURIAL DEPTH: 3.5 to 6 FEET**
- MAXIMUM HEAT PUMP SIZE: 5 TONS**

TRANSFER FLUID-WATER
NOTE: Antifreeze solution needed
 in northern zones.

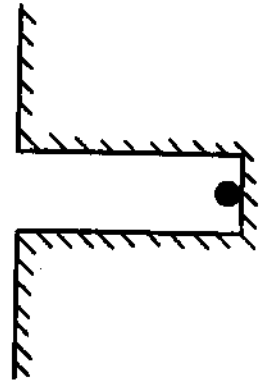
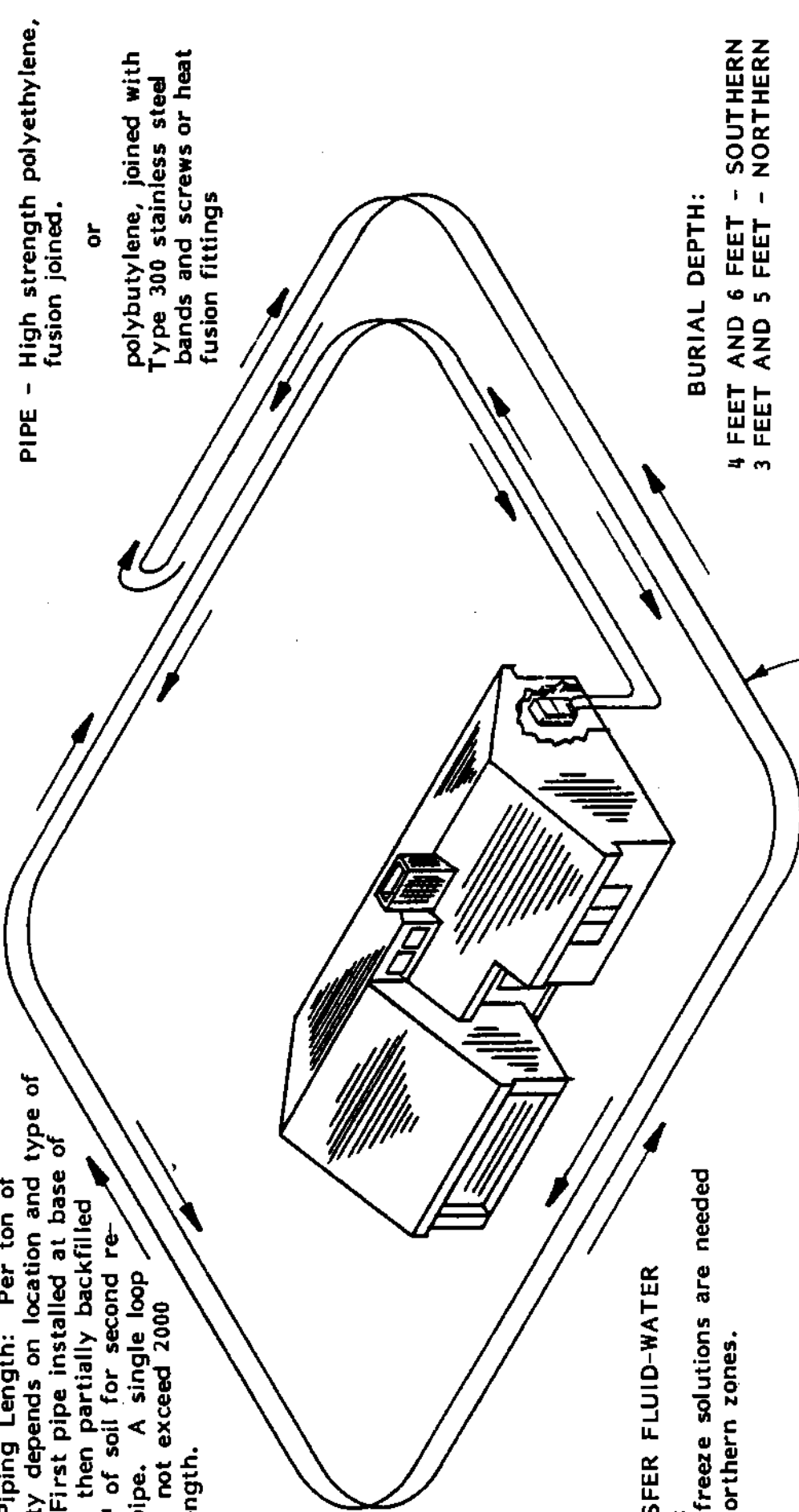

FIGURE 13
HORIZONTAL (SERIES) SYSTEM

TWO PIPES IN SAME TRENCH

Total Piping Length: Per ton of capacity depends on location and type of soil. First pipe installed at base of trench then partially backfilled with 2' of soil for second re-turn pipe. A single loop should not exceed 2000 feet length.

PIPE - High strength polyethylene, fusion joined.
 or
 polybutylene, joined with Type 300 stainless steel bands and screws or heat fusion fittings



TRANSFER FLUID-WATER
 NOTE:
 Antifreeze solutions are needed in northern zones.

BURIAL DEPTH:

4 FEET AND 6 FEET - SOUTHERN
 3 FEET AND 5 FEET - NORTHERN

Min. Space
 4 to 6 feet

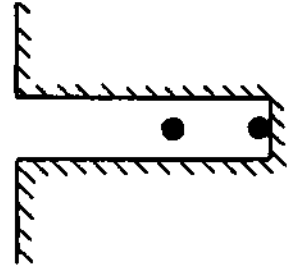

FLOW PATH: SERIES
TYPICAL PIPE SIZE: 1-1/4 TO 2 INCHES
PRACTICAL LENGTH: 210 TO 300 FEET OF TRENCH/TON
420 TO 600 FEET OF PIPE/TON

FIGURE 14
HORIZONTAL MULTI-LEVEL (PARALLEL) SYSTEM

Be sure the buried pipe system is properly designed for the heat pump load, soil type, climate, the pipe used, and the operating cycle pattern.

System uses 3/4" or 1" pipe, installed four ft. deep, spaced one foot apart vertically. Return bends as shown. Trenches spaced four feet apart. In Northern Zone, pipes are installed at 6 ft., 5 ft., 4 ft., and 3 ft. depths. In Southern Zones, pipes are spaced at 7 ft., 6 ft., 5 ft., and 4 ft. depths.

The use of smaller diameter pipes results in a thinner pipe wall and thus better heat transfer without sacrificing the pipe pressure rating. Parallel hookups are usually required in order to keep water pressure drops from being too high.

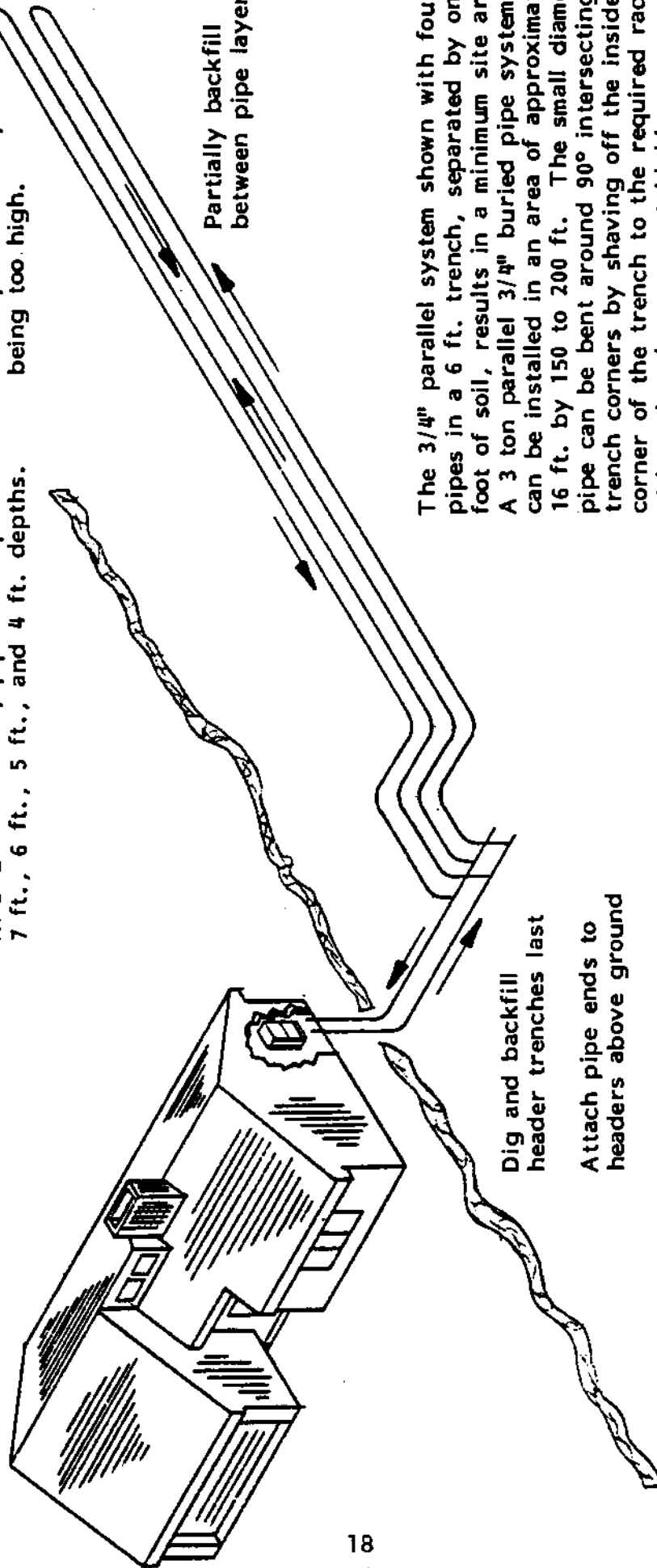

The 3/4" parallel system shown with four pipes in a 6 ft. trench, separated by one foot of soil, results in a minimum site area. A 3 ton parallel 3/4" buried pipe system can be installed in an area of approximately 16 ft. by 150 to 200 ft. The small diameter pipe can be bent around 90° intersecting trench corners by shaving off the inside corner of the trench to the required radius with a shovel to prevent kinking.

Dig and backfill header trenches last
 Attach pipe ends to headers above ground

- FLOW PATH: PARALLEL
- TYPICAL PIPE SIZE: PARALLEL PATHS 3/4 TO 1 INCHES
 HEADERS 1-1/2 TO 2 INCHES
- PARALLEL PIPE LENGTH: 500 FT. MAX. PIPE LENGTH (3/4 INCH)
 750 FT. MAX. PIPE LENGTH (1 INCH)

FIGURE 15
SOCKET FUSION

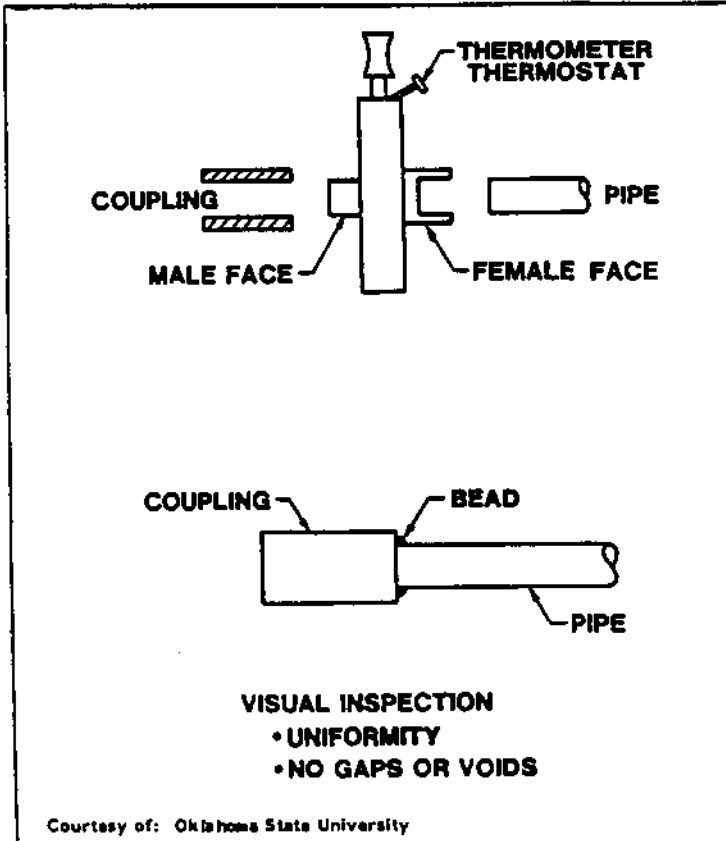

FIGURE 16
BUTT FUSION

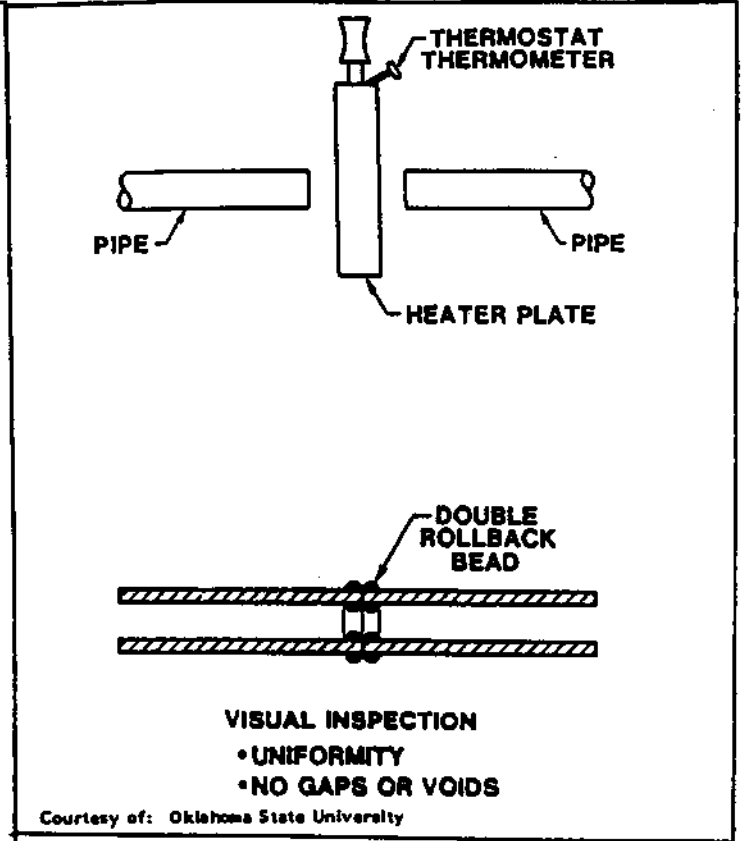
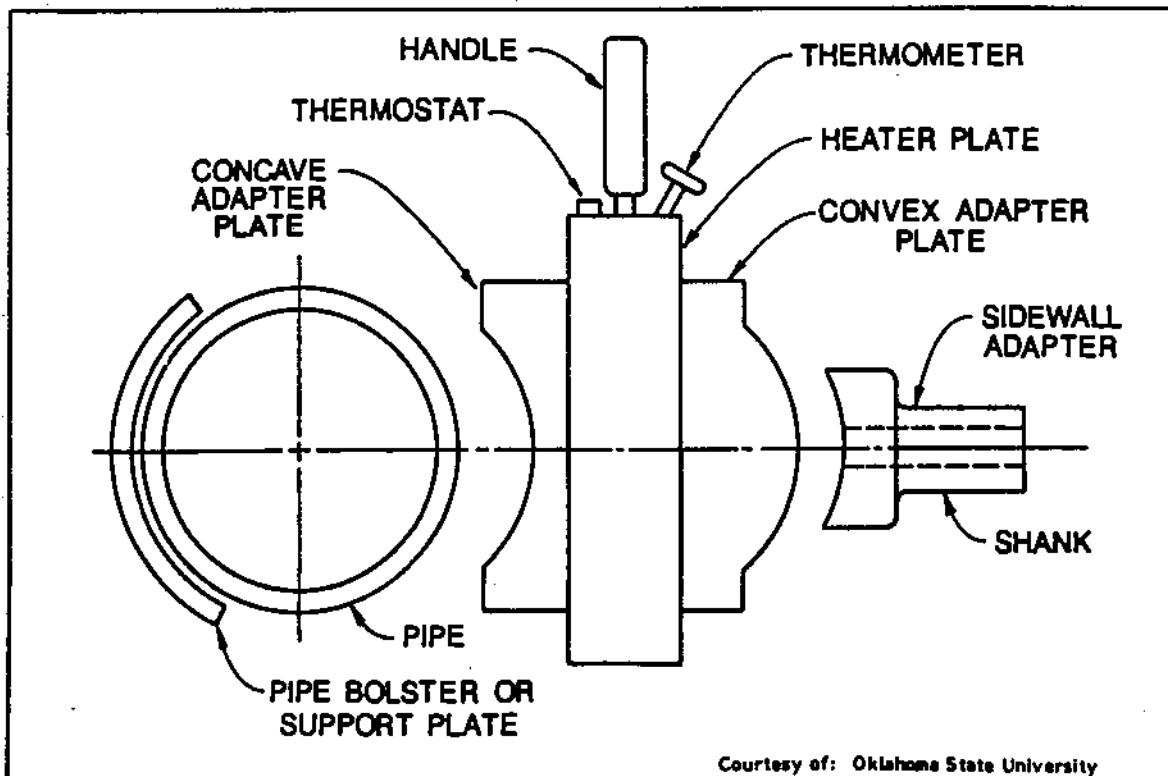

FIGURE 17
SIDEWALL FUSION



PIPE JOINING METHODS

HEAT FUSION--Heat fusion is the process where plastic pipe materials are aligned, cleaned or trimmed, heated to their melting point, brought together, and allowed to cool to form a homogeneous material. The appropriate ASTM standards are:

1. D2610 "Specifications for Butt Fusion Polyethylene (PE) Plastic Pipe Fittings, Schedule 40"
SCOPE:
2. D2683 "Specification for Socket-Type Polyethylene Fittings for Outside Diameter Controlled Polyethylene Pipe"
SCOPE:
3. D2657 "Practice for Heat Joining of Polyolefin Thermoplastic Pipe and Fittings"
SCOPE: This practice describes general procedures for making joints with polyolefin pipe and fittings by means of heat-joining techniques in either a shop or field environment.

For reliability, all underground piping joints should be thermally fused rather than mechanically coupled. The arguments for this are:

1. Heat fusion joining results in a joint which is stronger than the pipe itself. The pipe wall at this point has a larger cross section which gives the joint the added strength.
2. The connection or joint is all plastic eliminating corrosion problems.
3. There are industry standards (ASTM, PPI, --) which have written guidelines for proper joining methods.
4. Training programs are available from the manufacturers of the pipe and fusion machines.

HEAT FUSION METHODS--The industry has accepted two heat fusion techniques, butt and socket. The fusion method chosen will depend on the pipe manufacturer's requirements and recommendations and the ease in which field personnel can be trained to reliably fabricate ground heat exchangers.

SOCKET FUSION JOINING--In the socket fusion method, the two pipe ends are joined by fusing each pipe end to a socket fitting (see Figure 15). This requires two heat fusion procedures for each joint.

BUTT FUSION--The second type of heat fusing joining is the butt fusion procedure where the 2 pipe ends are simultaneously heated to a plastic state and brought together to form the heat fused joint (see Figure 16). A single heat fusion process is required to form the joint between the two plastic pipe ends. The butt fusion process is performed by using specially designed machines (available from several manufacturers) which provide secure holding of the two pieces to be fused, aligning the pieces, trimming and squaring their ends, heating the surfaces to be joined, and butting them together while they remain in a plastic state.

SIDEWALL BUTT FUSION JOINING--In addition to joining the flat ends of pipe or fittings, the butt fusion process can also be used when joining the concave surface of a service saddle to the convex surface on the sidewall of a pipe (see Figure 17). This is done by heating these surfaces with appropriate convex and concave shaped heaters and then butting these surfaces together. This is known as sidewall fusion joining. Typical butt fusion fittings are illustrated in Figure 16.

SELECTION OF HEAT FUSION METHOD--Polyethylene is heat fused and joined using both butt and socket procedures. Material grade, density, etc. will determine if the particular grade can be fused with either method. Some high density polyethylene materials cannot be socket fused.

Polybutylene in the sizes used in ground heat exchangers is normally socket fused.

Both fusion procedures when properly done yield highly reliable joints that are stronger than the pipe itself.

IV. DESIGN OF EARTH COIL

Earth coupling is a method by which water used by the heat pump is circulated through pipes buried in the ground. Heat is transferred to and from the soil through the walls of the pipe. Earth coupled systems are used in areas where insufficient ground water is available, or disposal of well water is impractical, or regulations prohibit the use of well water, or the environment corrodes outdoor condensing units. The piping may be buried in either a vertical or a horizontal configuration.

The first recorded experience of earth coupling a heat pump was a 1912 Swiss patent. The next period of earth coupling activity occurred after World War II in both the United States and Europe. In the period from 1946 to 1953, twelve major earth coil research projects were undertaken by the Edison Electric Institute. This research developed many of the basic theories and designs that are used in earth coupling today. Work on earth coupling was terminated because of low energy costs.

The majority of the research work in the United States since 1978 has been conducted at Oklahoma State University (OSU). Currently many universities and utilities are conducting continuing studies of earth coils.

GUIDELINES PROCEDURE

1. Calculate the cooling and heat loads
2. Determine duct capacity
3. Select heat pump
4. Determine type of earth coil
5. Select pipe for earth coil
6. Calculate length of earth coil
7. Choose fluid in earth coil
8. Layout pipes and fittings
9. Calculate pressure drop in feet of head
10. Select circulating pump or pumps

CALCULATE THE COOLING AND HEATING LOADS--Use ACCA Manual J, ASHRAE, or equivalent method of calculating heat gains and losses for the building.

DETERMINE DUCT CAPACITY--Use ACCA Manual D, ASHRAE, or equivalent to determine the CFM capacity of the duct system. If it is a new building design, ductwork to meet the needs of the heat pump must be selected.

SELECT HEAT PUMP--In an earth coupled system, the heat pump should supply the entire cooling load at design maximum entering water temperature. There is no problem if the heat pump is oversized for the heating load. However, if the heating load of the building exceeds the cooling load, the heating capacity of the heat pump shall be equal to or greater than 70% of the design heating problem if the heat pump is oversized for the cooling load. Once the heating and cooling loads are known, the heat pump can be selected. In earth coupling applications, heat pump selection involves several important considerations.

Unlike in well water applications where water temperature is constant, earth coupled systems must be designed for entering water temperatures that may vary between 30° on the low end and 110° on the high end. Consequently, when selecting a heat pump for earth coupling, one must determine capacity and efficiency at both high and low design entering water temperatures.

DETERMINE TYPE OF EARTH COIL--There are three basic earth coil designs listed below in order of difficulty.

1. Single layer horizontal
2. Double layer horizontal
3. Single U-bend vertical

The trenches should be spaced a minimum of 5 feet apart. Single layer horizontal systems are usually trenched a minimum of 4 feet deep as far north as Indianapolis. But in northern locations such as Chicago, the trenches are usually 5 feet deep. Double layer horizontal systems are trenched at 6 feet with the pipes installed at 4 feet and 6 feet. The boreholes for vertical systems are spaced a minimum of 15 feet apart. The depth of the borehole is determined by drilling conditions.

Earth coil systems may be designed for series or parallel flow. Series flow is easier to install and test but usually requires larger diameter pipe. Vertical systems with series flow do not need to have the boreholes the same depth. Parallel flow requires more care in installation but usually reduces pipe diameter and pressure drop.

SELECT PIPE FOR EARTH COIL--After years of testing and experience, the plastic pipes listed below have been found to be the most cost effective for earth coils.

Polybutylene 2110 SDR 13.5	Polyethylene 3408 SDR 11
Polybutylene 2110 SDR 17	Polyethylene 3408 Schedule 40

Use either butt or socket fusion to join the plastic pipe as recommended by the pipe manufacturer.

CALCULATING LENGTH OF EARTH COIL--Table 1 shows typical earth coil lengths which will provide adequate system performance in those areas of the country depicted in the table. However, precise calculations which consider the unique characteristics of each locale can reduce the length of coil needed and enhance the performance of the system.

$$L_h = \frac{12,000 \text{ Btuh/Ton (COP} - 1/\text{COP) (R}_p + \text{R}_s)\text{(F}_h\text{)}}{T_l - T_{min}}$$

$$L_c = \frac{12,000 \text{ Btuh/Ton (EER/3.41} + 1) - (\text{EER/3.41})(R}_p + \text{R}_s)\text{(F}_c\text{)}}{T_{max} - T_h}$$

Where:

L_h - Heating length in feet per ton of heat pump capacity
 L_c - Cooling length in feet per ton of heat pump capacity
 COP - COP of the heat pump at the design entering fluid temperature
 R_p - Pipe resistance
 R_s - Soil resistance
 F_h - Heating run fraction
 T_l - Low soil temperature at day T_o
 T_{min} - Design minimum entering fluid temperature
 EER - EER of the heat pump at the design entering fluid temperature
 F_c - Cooling run fraction
 T_{max} - Design maximum entering fluid temperature
 T_h - High soil temperature at day to +180

IMPORTANT: Generally, in southern locales the cooling length will be longer while in northern areas the heating length will be longer. Always select the longest earth coil length for each installation.

The first element to consider is heat pump COP. Remember this is not the COP at well water temperature but the COP at the loop entering water temperature. This loop temperature will range between 30° and 50° depending upon location and loop design. Typically the average January COP is between 2.8 and 3.1. Note that earth coil systems are designed for the peak demand months of January and August. As a result, a system may have a January COP of 2.9 and a March COP of 3.1. Some southern applications might have a COP greater than 3.1 but in those locations the cooling load is dominant.

Just as the COP must be for the January entering water temperature, so the EER must be for the August entering water temperature. Typically the entering water temperature ranges between 70 and 100°. Typical EER values fall between 10 and 11.

Pipe resistance is the next element to consider. It is calculated using Fourier's equation.

$$R_p = \frac{1}{2 \pi K_p} \ln \left(\frac{D_o}{D_i} \right)$$

R_p - Pipe resistance
 K_p - Thermal conductivity of pipe (Btuh/Lft - °F)
 \ln - The natural logarithm
 D_o - Pipe outside diameter (ft)
 D_i - Pipe inside diameter (ft)

The calculation of soil resistance is based upon the Kelvin Line Source Theory. This theory is set out in the following equation.

$$R_s = \frac{I(x)}{2 \pi K_s}$$

R_s - Soil resistance
 $I(x)$ - Integral
 K_s - Thermal conductivity of soil (Btuh) Lft - °F (See Table 1)

The above discussion assumes unfrozen soil. Frozen soil has less resistance to heat transfer. In addition, freezing soil releases 144 Btu/Lb of latent heat.

The heating run fraction is the% of time the heat pump is assumed to run during the peak month of January. The cooling run fraction is the same except it represents the operation in August. Both numbers have been developed from a Department of Energy study and assume that the heat pump has a capacity equal to the design load of the building.

CAUTION: The run fraction will increase if the heat pump is undersized. For example, in Chicago, Illinois, the heating run fraction for 2,400 square foot medium insulated house is .44. If the heat pump supplies only 75% of the design heating load, then the run fraction will increase to more than .65. At some point, undersizing will lead to 100% run time or a run fraction of 1.0.

There are two benefits for sizing the heat pump as close to design load as possible.

1. It lessens any future residential demand charges for electricity and
2. It lowers the run fraction which decreases pipe length.

FIGURE 18
SOIL TEMPERATURE SWING

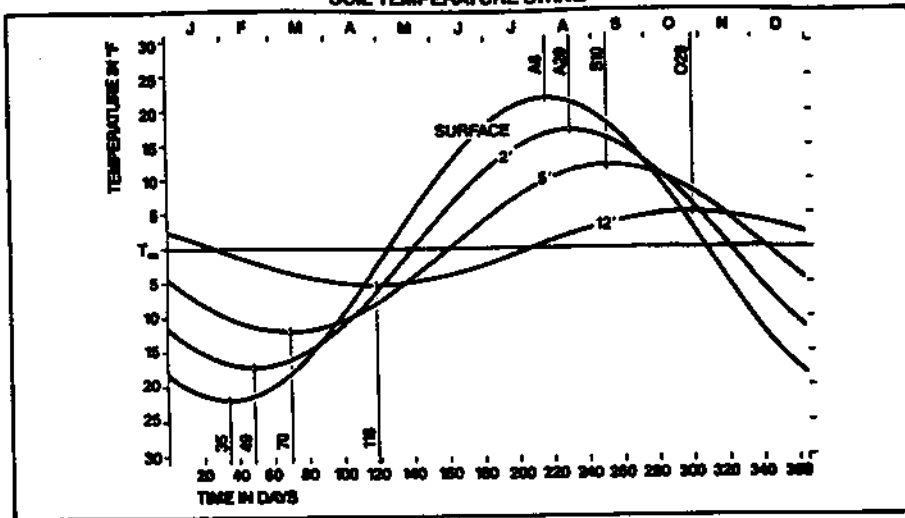

FIGURE 19
COMPARISON OF T_m AT VARYING DEPTHS
FOR DIFFERENT SOILS

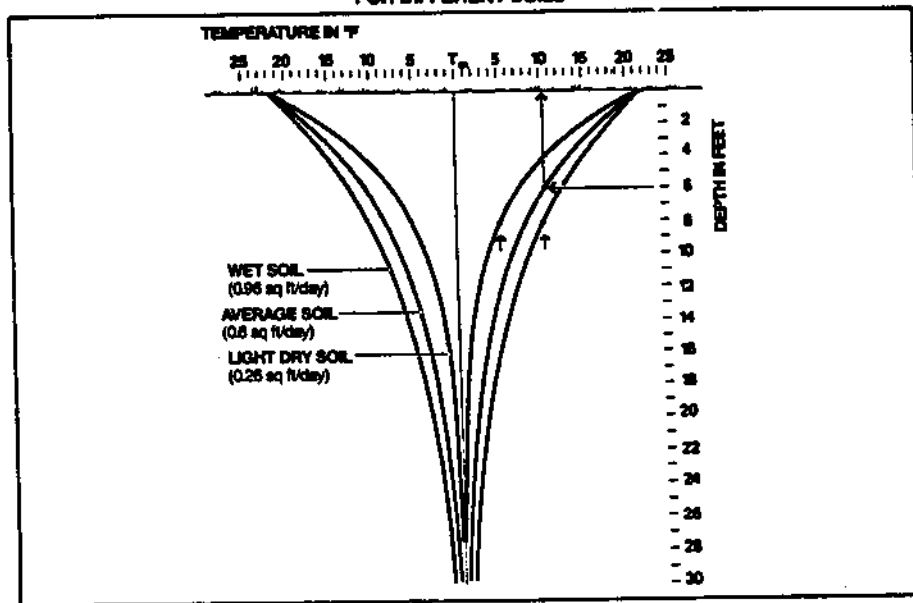
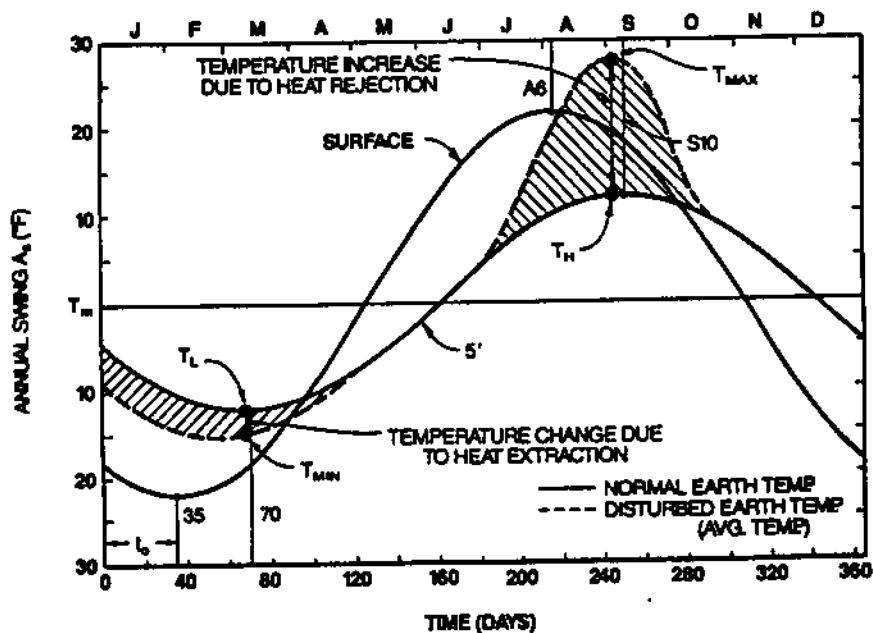

FIGURE 20
HORIZONTAL EARTH COIL
TEMPERATURE VARIATIONS



The last element to be considered is the allowable temperature differential of the earth coil. This number is the amount of temperature swing from the peak soil temperature which the system is designed for and the heat pump can use. It can be expressed by the following equations.

$T_{hd} = T_i - T_{min}$
 $T_{cd} = T_{max} - T_h$
 T_l - Low soil temperature
 T_h - High soil temperature
 T_{min} - Design minimum entering fluid temperature
 T_{max} - Design maximum entering fluid temperature

NOTE: Although Bard heat pumps can operate between 25 and 110°, all designs should allow some margin for error.

T_i and T_h represent the peaks of the annual temperature wave. This wave is represented by Figure 18. The formula for calculating the temperature of the undistributed soil at a depth for a given day is set out below.

$$T_d - T_m = A_s (e^{-X\sqrt{II/365a}} / 2) \cos(2 II/365(t-t_0) - \pi/2\sqrt{365/IIa}) / 2$$

T_d - Soil temperature on that day
 T_m - Mean annual soil temperature
 A_s - Annual soil temperature swing
 e - Exponential logarithm
 x - Depth in feet
 T - Day of the year
 T_0 - Phase constant, day of minimum surface temperature
 a - Thermal diffusivity of soil (ft²/day)

T_m can be assumed to equal well water temperature from a well of 50 to 100 foot depth. It can be approximated by adding about 2 °F to the mean annual air temperature. Typically, the minimum surface temperature (T_0) falls within one week of February 4. The maximum surface temperature will occur within about one week of August 5. There is a phase lag with increasing depth. This lag averages about one week per foot of depth.

For complete design data, refer to "Design/Data Manual for Closed Loop Ground-Coupled Heat Pump Systems" by J.E. Bose, published by American Society of Heating, Refrigerating and Air Conditioning Engineers, Inc., 1791 Tullie Circle, N.E., Atlanta, GA 30329 or attend a Factory School on Water Source Heat Pumps at Bard Manufacturing Company.

Bard Manufacturing will design the earth loop for your if you desire. Just complete the enclosed Worksheet, Form No. F1115 and send to:

Earth Coupled Loop System Design
 Bard Manufacturing Company
 P. O. Box 607
 Bryan, Ohio 43506

The information will be inputted into a computer and a printout with various earth loop designs will be sent to you.

SOIL IDENTIFICATION

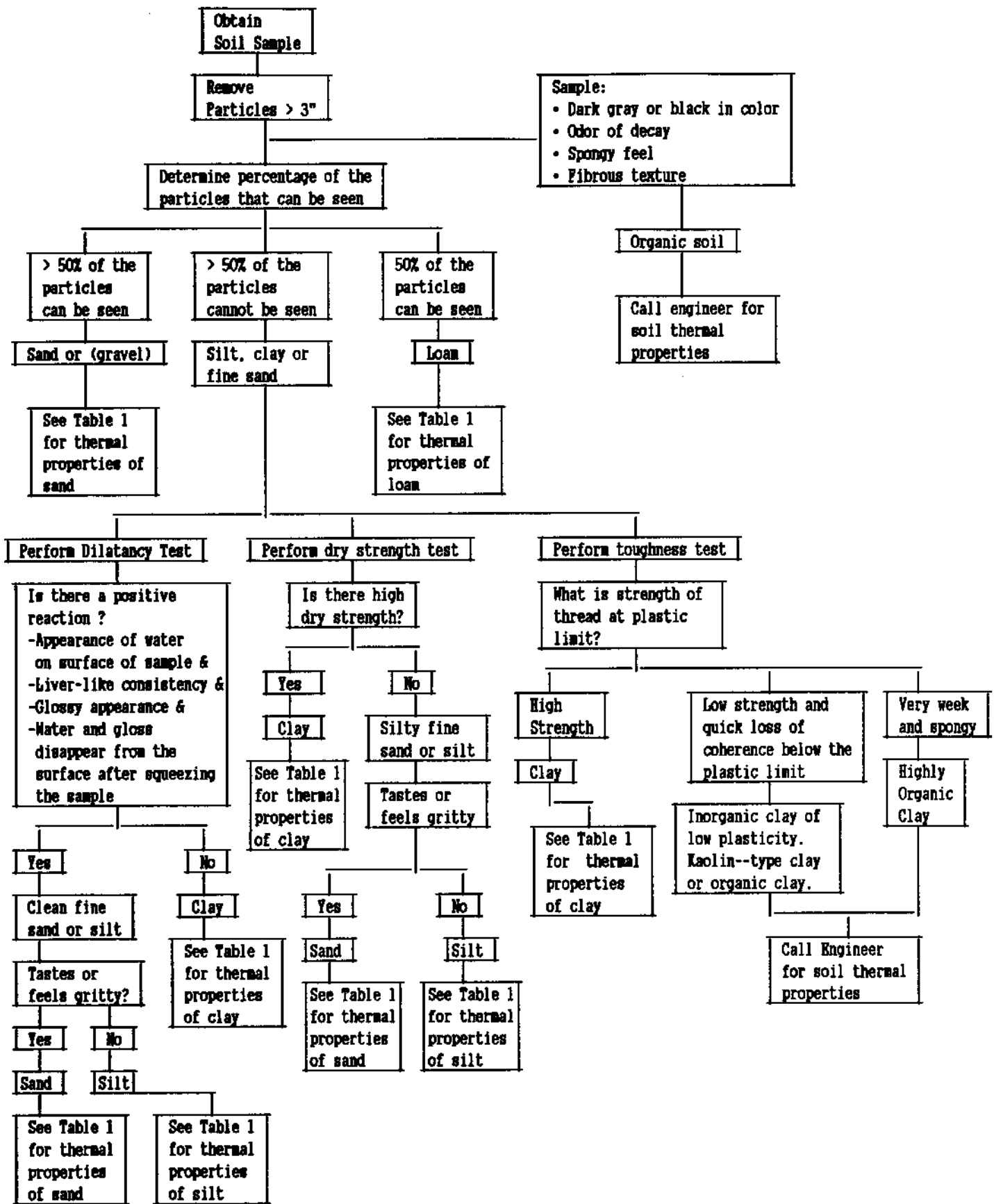

For complete soil data, refer to "Soil and Rock Classification For The Design of Ground-Coupled heat Pump Systems" edited by James E. Bose, distributed by International Ground Source Heat Pump Association, Stillwater, OK.

V. INSTALLATION OF THE EARTH COUPLED GROUND HEAT EXCHANGER

IN THIS SECTION--Site Plan, Installation Equipment, and Pipe Installation Considerations.

Installation of the ground heat exchanger will for most persons involve a new skill or trade. As the industry develops, it appears that a new trade is being formed, that is, the notion of a loop installer whose primary purpose is to install, pressure test, and connect it to the residence. In this way, the HVAC person sees two water lines or taps that can be connected to the heat pump as specified by the manufacturer, distributor, or dealer. The loop contractor in many cases is responsible for final grading and restoration. In any case, the person responsible for the overall project must be identified to the customer.

SITE PLAN

The site plan is a location description of the buried underground utilities that serve a given area. Two things are for certain:

1. Memories fail and utility lines seem to move underground with time and
2. Installation costs go up dramatically as the number of services are cut or severed.

Figure 21 has some of the types of services that need to be identified by locator services that are available in most areas. The location description and sketch should include:

1. The location of all buried utilities. Locator services for electrical, telephone, and gas service are available and can usually be found in the local telephone book. These services are generally at no cost to the homeowner or contractor.
2. The location of the ground heat exchanger should be established from two permanent points in case of future excavations.

The owner should be consulted to determine if:

1. Special areas are to avoided. Trees, shrubs, and gardens that are not to be disturbed should be identified.
2. Acceptable locations for entry and exit of heavy equipment. Be cautious, they may not know the limits of their driveway. The contractor is generally liable! A lightweight machine with large flotation tires can reduce pavement and yard loads. Machine with four-wheel steer can maneuver in crowded locations.
3. Services like underground water sprinklers may not be known or easily identified by the contractor. Ask the owner to uncover these buried systems or agree in writing in advance that the contractor is not liable.

INSTALLATION EQUIPMENT

Chain trenchers, bulldozers, backhoes, and vibratory plows are used to bury horizontal ground heat exchangers. The economic choice of which machine to use depends on local site conditions and the competition situation. Generally speaking, the machine which moves the least amount of soil will be the most cost productive. Figure 22 describes the various machines that have been used to bury horizontal ground heat exchangers.

CHAIN TRENCHERS--In many cases, trenchers are the most economic choice since the amount of soil or dirt removed is minimal when compared to other methods, and trenching productivity is usually much higher than that of a backhoe. Systems are now being developed which allow the automatic placement and backfilling of multiple pipes in a single trench simultaneously. A trailing vibrator and the addition of water to form a slurry has increased productivity significantly for the multiple pipe system. Trench widths are about 6 inches with depths to 7 feet for 65 horsepower trenchers. The most common size chain trencher is in the

depth range of 3 to 5 feet. A 6 foot boom costs about 5% of the cost of a trencher. Multiple pipes in the trench greatly reduce trench length and the area required for a horizontal buried pipe system.

FIGURE 21
LOCATION DESCRIPTION OF UNDERGROUND UTILITIES
COURTESY OF OKLAHOMA STATE UNIVERSITY

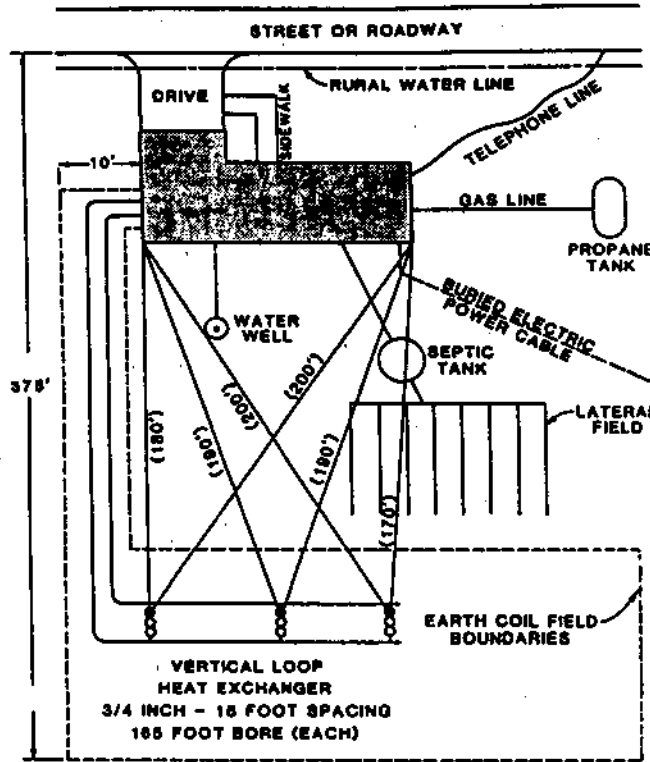

BULLDOZERS--Method A using a bulldozer would only be appropriate if the soil had been removed for some other purpose or if excavation for a large header system were required.

In larger installations in Europe, track type machines have been used to plow in horizontal ground heat exchangers and backfill around the pipe in a continuous operation. The backfill process consists of a hopper and chute arrangement which places the material in the immediate pipe area.

FIGURE 22
FOUR BASIC INSTALLATION TECHNIQUES
COURTESY OF OKLAHOMA STATE UNIVERSITY

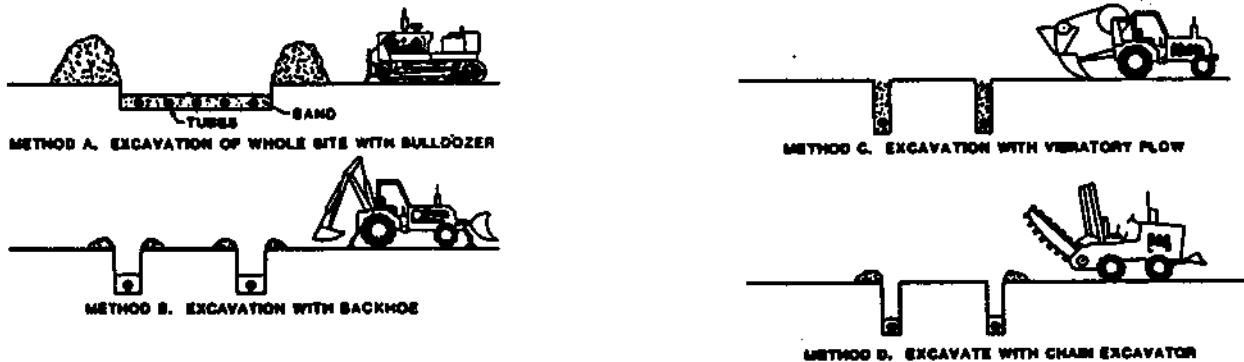

BACKHOES--Backhoes (Method B) have been used where there is a presence of rocks, cobbles, or boulders which are too large or too hard to be removed by a chain trencher. Backhoes have also been used where more than one pipe is placed in a single trench either stacked vertically (such as 1 x 2) or multiple pipes placed horizontally in several layers (2 x 3). **NOTE:** The nomenclature 1 x 2 defines a pipe system of 1 level or layer and 2 pipes. A system of three pipes at 2 levels or layers would be denoted as 2 x 3. The backhoe may also be used to open the site from the foundation to the ground heat exchanger. The soil removed by a backhoe tends to be lumpy and can leave air pockets around the pipes greatly reducing the heat transfer.

VIBRATORY PLOWS--Vibratory plows are commonly used at depths not greater than 3 feet. To facilitate rapid burial, a vibrator or vibratory plow is used to improve the speed of placement and reduce the size of machine. Loose or unstable soils are also amenable to this type of pipe placement and they work better than a chain trencher in glacial till. The shallow depth results in larger seasonal soil temperature swings and longer lengths of pipe.

DRILLING MACHINES--Drilling is required to install vertical loops. Two applicable techniques for boring holes are: (A) mud and air rotary drills, and (B) standard augur or hollow-stem augur drilling. Boring holes for earth loop inserting and boring holes in order to find and produce water wells are two completely different tasks. The ground heat exchanger application is much simpler. Since the objective is to install a specified length of heat exchanger in a vertical configuration, it is not important to reach a given depth at a particular site. If 600 feet of bore hole is required, two 300 foot vertical bore holes are acceptable and may be more cost effective. Soil and rock conditions will determine drill rates and consequently determine an economic borehole depth. Since ground temperatures fluctuate near the surface, hole depths greater than 50 feet are normally recommended. However, the 50 foot depth is not a minimum value. Some general guidelines are as follows:

1. Soil moisture and temperature stability generally increase with depth which favors the deeper holes.
2. Fewer holes mean less connections at the surface which can be a time saver, also less surface area required.
3. If "many" holes are drilled, several boreholes may need to be connected in series before tying back to the main header. Too many parallel flow paths can result in low flow and reduced performance of the ground heat exchanger.
4. If hard rock layers are encountered, it may be more profitable to move and repeat the process.
5. Extensive hard rock in a drilling service area can easily justify a down-hole hammer or the use of a rock quarry drilling contractor with a top-hole hammer.
6. Vertical loops using 3/4 inch or 1 inch pipe and a close U-bend require only a 3 - 4" hole. This smaller drilling system needs less mud flow, a smaller and less expensive bit, smaller mud pans, a smaller mud pump, and results in less wear and tear on the mud pump. In many cases, this will result in lower drilling costs.

The borehole does not need to be cased for performance reasons. It may need to be cased if the soil is unstable or a formation presents a problem due to lost circulation during drilling. The borehole must only remain open long enough to insert the ground heat exchanger. Most of these problems can be controlled by proper mud formulation and use. Drilling rates are faster than water well drilling which generally requires sampling and casing. Well completion procedures are not required which greatly reduces time and cost.

In mud or air rotary drilling, the drill rig rotates the drill pipe and sends either high pressure fluid (air, water, or mud) down the inside of the drill pipe to lubricate and cool the bit and to bring the cuttings back to the surface along the outside of the drill string. In rotary mud drilling, removed soil or earth is collected in a mud pan to be replaced in the hole or removed from the job site if necessary. Drilling mud (bentonite or fluid additives) are added to the mud to control its viscosity and to prevent a number of drilling problems. If the drill cuttings are of a high density, the drilling fluid viscosity must be increased to carry the cuttings to the surface. The mud must also be dense enough to support the borehole wall if the surrounding soil is unstable or be sized to form a clay deposit on the wall of the hole if the

mud tries to leak through the wall of the hole into a porous formation. The proper mud mix can also prevent swelling. A less dense mud may be required to keep mud from migrating through surrounding porous formations.

In extreme cases of unstable soils, drill pipe with large inside diameters are used which allow loops with U-bends to be inserted inside the drill string before its removal. The drill bit in this case has a knockout point which allows the U-bend and loop to remain in the bore hole while the drill string is removed.

In hollow-stem auger drilling, the drill rig rotates a hollow auger with cutting teeth and a temporary point at the bottom. The drilling operation may be completely dry and hence clean at the surface. Most of the cuttings are brought to the surface but some of them are simply pushed into the walls and compacted in place. The hollow auger essentially serves as a casing in the hole as it is drilled. When a hole is completed, the point at the bottom of the auger is pulled, the ground heat exchanger is inserted, and then the hollow auger is pulled or screwed out. In some designs, a disposable bit point is used which allows a weight on a rope to be used to "knock out" the disposable point. Auger drilling is applicable in a limited number of different soils and can present some serious problems in clay or adhesive soils or rock. In moist soils, auger drilling is slower than rotary mud or air drilling.

PIPE INSTALLATION CONSIDERATIONS

Consistently successful plastic pipe installations for ground heat exchanger applications are the result of good planning, the use of suitable materials and equipment, and close attention to the correct procedures.

Time spent in careful planning will substantially reduce the time and cost of the installation.

The following factors should be considered during planning:

1. Depth of trench as influenced by climate, soil type, and size of trencher available.
2. Length of trench as influenced by the area available, the heating and cooling load, the number of pipes in the trench, type of soil, and moisture content of soil.
3. Depth and number of vertical holes, if used, as influenced by the area available, obstruction, the heating and cooling load, and soil and rock types.
4. Trench pattern as influenced by above and below ground obstructions, ground slope, trenching turn radius limitations, backfilling and restoration requirements. (Be sure all buried conductors are located and marked).
5. Type and size of trenching chain, as influenced by type of soil and rock, depth of trench, and size of trencher.
6. Type of plastic pipe. Use of high quality polyethylene or polybutylene. PVC is not acceptable in either heat transfer characteristics or strength.

Several factors to be considered regarding the trenching phase in order to minimize problems are time and cost.

1. A combination of narrow chain, correct teeth, 4-wheel steering for maneuverability, 4-wheel drive for good traction, good backfilling capability with a 6-way blade, and high enough horsepower to finish most jobs in one day, will minimize expensive interruptions and complications due to weather and variations in soil conditions.
2. Remove rocks left in the bottom of the trench to eliminate damage to the pipe. Use long-handled tongs.
3. A backhoe attachment with a 12 inch bucket may be needed to dig out large rocks and dig access hole at the building.
4. Where murky or sandy conditions cause caving, use a pipe guide mounted on the trenching boom to guide the

pipe down to the bottom of the trench as it is dug.

5. Two by six (2 x 6) boards inserted in previously dug trenches and wedged will prevent dirt from an intersecting trench from having to be removed from the previous trench. Place a piece of plywood over the near length of the previously dug trench.

The pipe installation phase can be accomplished as this trenching proceeds. Be sure that the following procedures are followed:

1. Inspect the trench to insure that rocks are removed. Also remove rocks from the edge of the trench and from the top of the spoils pile so they will not fall in with the 4 - 6 inch of fines or sand that are first put in the trench to support and cover the pipe for protection.
2. Inspect the pipe as it is laid out beside the trench for cuts, kinks, or other damage.
3. Make all joints while the pipe is laying beside the trench and test with 40 psi air pressure and soap.
4. Joints must be mechanically strong enough to force the pipe to absorb the stress and strain of the length expansion and contraction caused by the temperature changes in the circulated water. Pipe ends should be extra long and not cut for attaching the end fittings until the rest of the pipe has reached soil temperature in the trench.
5. Carefully lower the pipe into the trench after the bottom has been again checked for rocks and the fines smoothed.
6. If the soil is a heavy clay in very dry climates, it may shrink away from the pipe as it dries when heated during the summer cooling cycle operation of the heat pump. Use a sand fill around the pipe or a subsoil drip irrigation line buried a few inches above the pipe. The sand will crumble to maintain contact with the pipe. Add water with a drip line when in-out water temperature indicates reduced heat transfer through the pipe to the soil.

The backfilling is critical and its successful completion depends on the following good procedures.

1. If the rocks have been removed from the edge of the trench and the top of the spoils pile and the dirt has not formed clods due to rain, an experienced trencher operator can angle-blade the top of the spoils pile into the trench on the first pass. A worker should follow closely and tamp the fins by hand and make sure no rocks fall in.
2. Several more passes with the angle blade should be used to make the backfilling as uniform as possible and to prevent bridging.
3. Several stages of tamping and rolling over with the trencher wheels may be necessary to complete the job.

Additional considerations are required when closed vertical loops are used in limited site areas.

1. SOIL CONDITIONS--These will determine whether the augur, recirculating mud, or down-hole hammer method is used. It will also determine the type of drill bit and whether a mud additive is required.
2. The depth and number of holes for vertical loops depends on the heating and cooling load, the drilling rate, the site area, soil and rock types, and moisture level.
3. Each loop should be assembled, laid out straight, taped to reduce springback friction, and carefully tested for leaks and flow before the hole is drilled so that it can be lowered into the hole before it can cave in or the mud can settle to the bottom of the hole. The hole should be 5 - 10 feet deeper than the length of the loop to accommodate expansion of the loop. Fill the loop with water prior to insertion. If the hole is to be grouted in place, it should be filled with water and pressured to a level that will prevent the pipe from being crushed by the denser backfill material.

Taping short lengths of scrap steel rebar on the end of the pipe loop will hold the loop end straight and offset buoyancy of the plastic to make insertion easier and faster.

4. Test the loops after they are connected with 40 PSI air or water.
5. Grouting is an important aspect of the installation of a vertical closed-loop ground heat exchanger when used with a ground-source heat pump system. Not only will it provide the proper heat transfer between the ground necessary for the most efficient operation of the ground-source heat pump system, but it will also provide groundwater protection.
6. Environmental Reasons For Grouting
 - A. Prevents leakage downward along the pipe from surface or near surface contamination sources.
 - B. Prevents the migration of water between aquifers.
 - C. Seals off formations which are known to be contaminated.
 - D. Preserves the hydraulic characteristics of artesian formations and prevents leakage upward along the pipe.
7. Grouting Methods--Several basic principles apply to the grouting operations required for sealing the annulus between the pipe and the borehole. They are as follows:
 - A. It is of the utmost importance that complete organization in the grouting operation be demonstrated. A successful grout job requires a sequence of events to occur without mechanical failure or human error. Sudden problems can create the need for operational alternations. For this reason, flexibility is crucial.
 - B. High-solids clay grout slurries must be placed into the annular space from the bottom to the top and not from the top to the bottom. In other words, slurries cannot be poured from the surface into the annular space. When grout is placed at the bottom of the space to be grouted and appears at the surface, it is known that grout is present from the top to the bottom. Methods involving pouring grout from the surface are not reliable because bridging may occur and depth of grout descent cannot be verified easily.
 - C. Prior to insertion of the loop into the borehole and the grouting that will follow, the borehole should be cleared of cuttings or any bridging that may have occurred by establishing circulation of drilling mud or fresh water. Circulating drilling fluid may also help reduce loss of grout into fractures or permeable formations.
 - D. Grout pump suction and discharge hoses should be adequately sized to overcome friction losses and decrease chances of plugging. The use of a 3 to 4 inch suction line and a 1-1/4 to 2 inch discharge line is standard practice.
 - E. When the grout pump is also used for grout mixing, the discharge hose should be valved in a manner to allow changeover from mixing to pumping grout into the annulus without shutting down the pump.
 - F. A pressure gauge should also be installed on the grout pump discharge and monitored during operation. This is especially important if the pump begins laboring or if grout flow suddenly stops. Always keep the operating pressure below hose and piping pressure ratings.
 - G. Suction and discharge hose connections to the pump should be made using quick-connect-style couplings. This saves time when attempting to locate a blockage in one of the hoses.
 - H. A vigorous preventive maintenance program for mixing and pumping equipment compressors, hoses, and fittings is essential. This includes adequate cleanup of equipment after each grouting job. Failure

of equipment in the field can result in waste of grouting material, lost labor costs, property damage, and an unsuccessful or incomplete grouting job.

- I. An ample supply of fresh water must be on the job site for grout preparation and equipment cleanup. Only water suitable for drinking should be used for preparing grout slurries. Surface waters and water containing a high dissolved mineral content should not be used since they may adversely affect performance of grouting materials.
- J. A contractor who has little or no experience grouting or who purchases new mixing or pumping equipment should try out the equipment at his shop before taking it to an actual job site. A thorough knowledge of pump disassembly and reassembly procedures is also helpful.

For further information on grouting, refer to "Grouting Procedures for Ground-Source Heat Pump Systems" by Frank Eckhart, published by Ground Source Heat Pump Publications, Oklahoma State University, Stillwater, OK.

FIGURE 22A
GROUT PIPE METHOD WITH PUMP

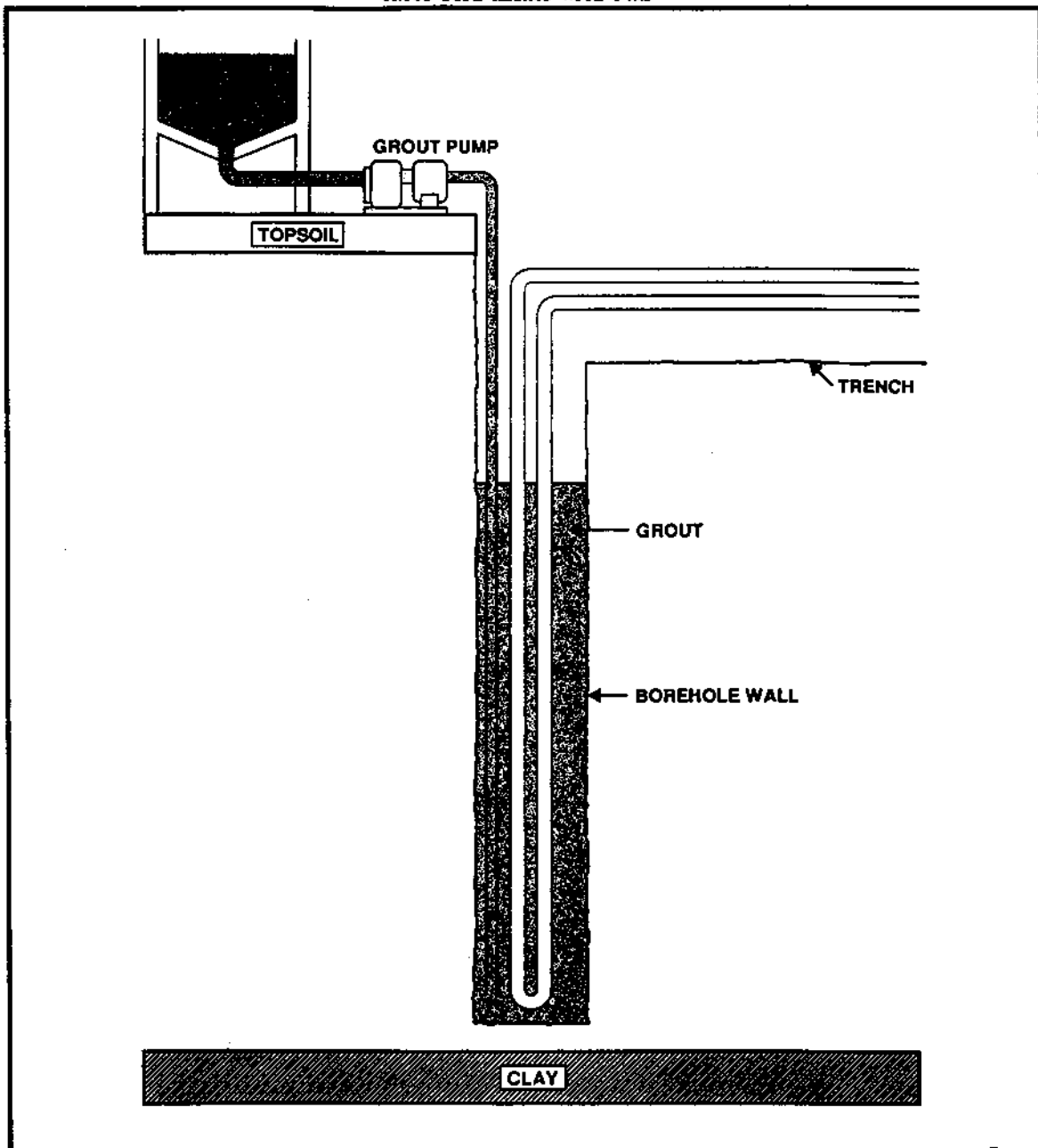

VI. THE CIRCULATION SYSTEM DESIGN

Equipment room piping design is based on years of experience with earth coupled heat pump systems. The design eliminates most causes of system failure.

Surprisingly, the heat pump itself is rarely the cause. Most problems occur because designers and installers forget that a closed loop earth coupled heat pump system is NOT like a household plumbing system.

Most household water systems have more than enough water pressure either from the well pump or the municipal water system to overcome the pressure or head loss in 1/2 inch or 3/4 inch household plumbing. A closed loop earth coupled heat pump system, however, is separated from the pressure of the household supply and relies on a small, low wattage pump to circulate the water and antifreeze solution through the earth coupling, heat pump and equipment room components.

The small circulator keeps the operating costs of the system to a minimum. However, the performance of the circulator MUST be closely matched with the pressure or head loss of the entire system in order to provide the required flow through the heat pump. Insufficient flow through the heat exchanger is one of the most common causes of system failure. Proper system piping design and circulator selection will eliminate this problem.

Bard supplies a worksheet to simplify head loss calculations and circulator selection. Refer to "Circulating Pump Worksheet" section.

Two general methods are used to pipe the water circuit in the equipment room. The first and easiest to use is to install a pump module. This module comes complete with connecting hose and heat pump adapters available from Bard. A second method is to "site build" the piping at the installation.

To move the transfer fluid (water or anti-freeze and water solution) through the earth loop system and the water source heat pump, some type of circulation system is required. Design of circulation system must include provisions for the following (see Figure 23):

1. Selection of a circulation pump or pumps for total system.
2. Providing air bleed off before start-up running.
3. Providing for flow monitoring.
4. Positive pressure control and limiting.
5. Antifreeze charging capability.

FIGURE 23
CLOSED LOOP EQUIPMENT ROOM PIPING
DRAWING COMPLIMENTS OF OKLAHOMA STATE UNIVERSITY

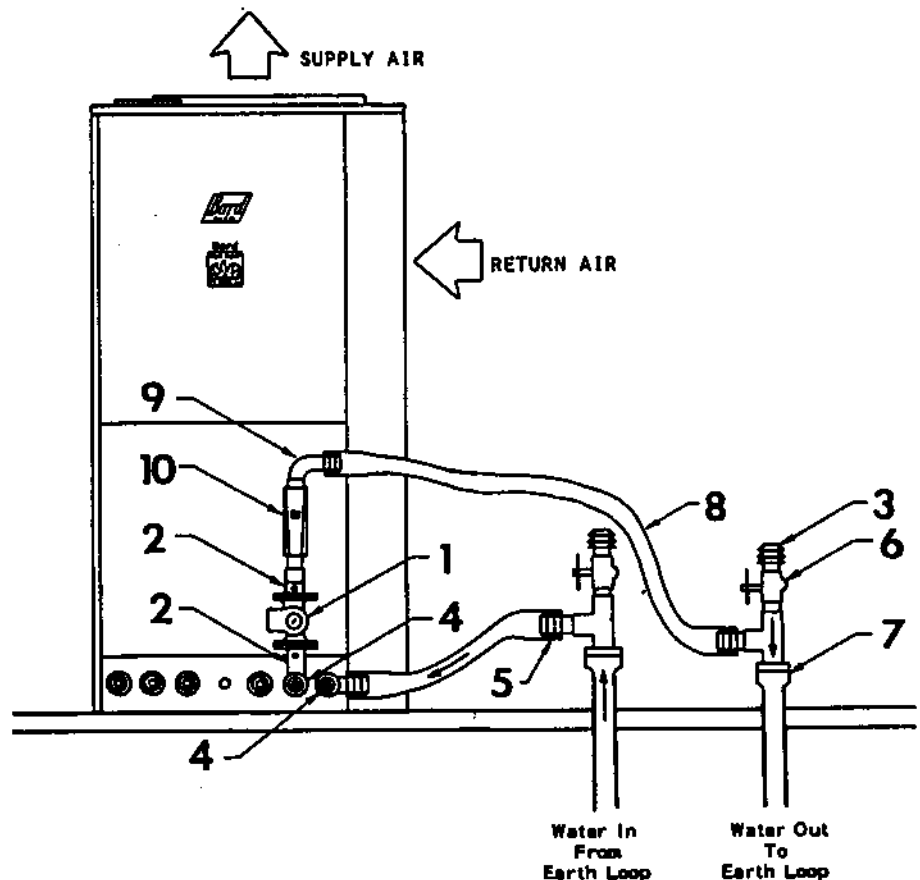

NOTE: The expansion and contraction of earth loop piping will cause a 50 to 60 psig water pressure change in system between summer to winter.

The components for a circulation system are (see Figure 23):

1. Circulating Pump systems are engineered for each individual system to provide the correct water flow and overcome the friction loss of the system piping. Isolation flanges or ball valves are used to isolate pump from system piping. You need to be able to remove the pump from piping without losing the transfer fluid for repairs if ever required.

* Determining pressure drop and selecting a circulation pump or pumps. It is very important in selecting the circulating pump that a very accurate pressure drop calculation be made because final pressure drop at the selected pump must pump against will to determine the actual flow rate (GPM) that is delivered to the water source heat pump, the pumping cost and efficiency of the entire system.
2. Ball Valve and Flange
3. Barb X MIP Brass Adapter
4. Brass Test Plugs--In order to start up and troubleshoot a closed loop system properly, water in and water out temperatures at the heat pump must be monitored. A test plug is installed on one leg of each connection line. A probe thermometer can be temporarily inserted, the temperature monitored and the thermometer removed. Use one thermometer to monitor these temperatures. Using two different thermometers to measure the temperature differential can introduce large measurement errors. They are also used to measure pressure drop to determine coil flow rate.
5. Bard X Insert Brass Adapter
6. Two Boiler Drains are located on both sides of the circulator for final filling, air purging and antifreeze addition.

The top drain should be the highest point in the equipment room piping. This will help purge air out of the system during final filling at start up.

7. PE or PB pipe to fit transition.
8. One inch reinforced flexible hose
9. 90° street ell (brass)
10. Flow Meter (Bard part No. 8603-017)--or equivalent side to monitor water flow is recommended.

HEAT PUMP CONNECTIONS WITHOUT PUMP KIT

The units have various female connections inside on water coil. To keep head losses small, all piping and components in the heat pump should be one inch copper or plastic. The transition to one inch pipe should be made at the exterior of the heat pump if 3/4 inch piping is used in small heat pump models.

Be sure to use a back-up wrench when installing the adapters to the heat pump.

PIPING CONNECTIONS

Up to 12 feet of reinforced flexible hose is used. Cut hoses to the desired lengths and install with as few bends as possible. Close bends increase pipe head loss so any bends should be as wide as possible. Use the clamps to secure hoses in position.

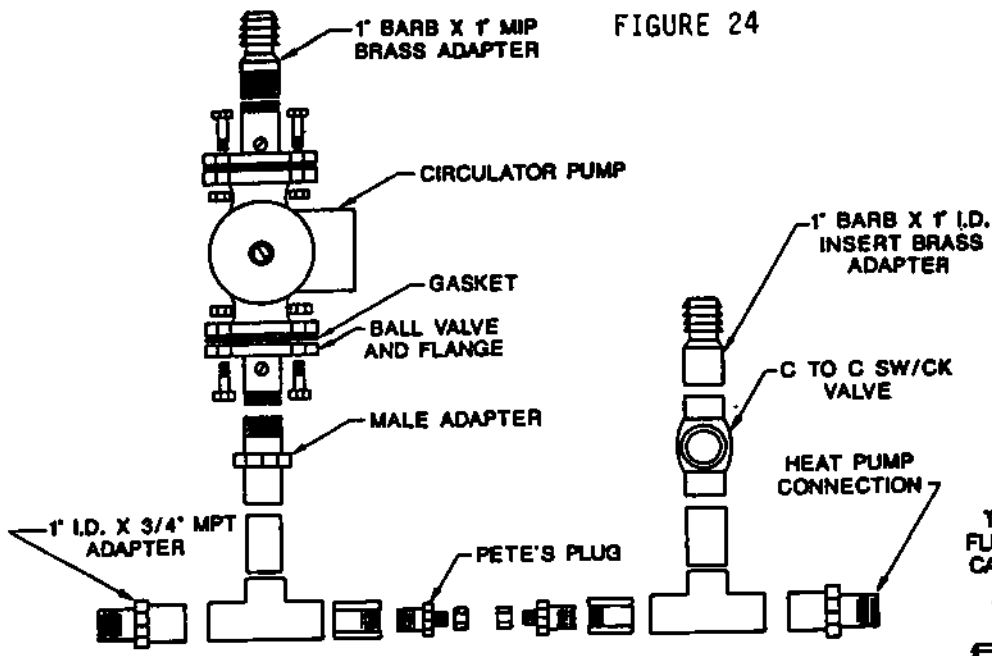
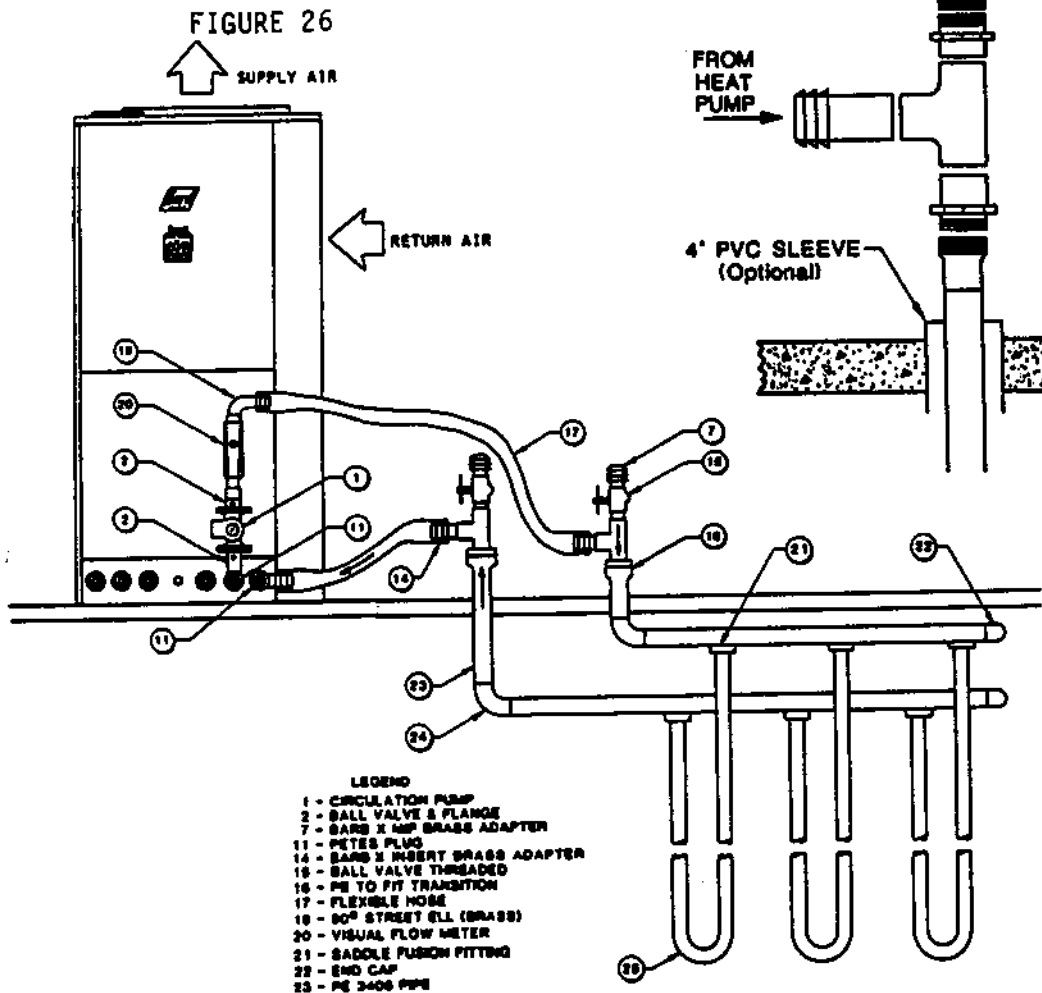
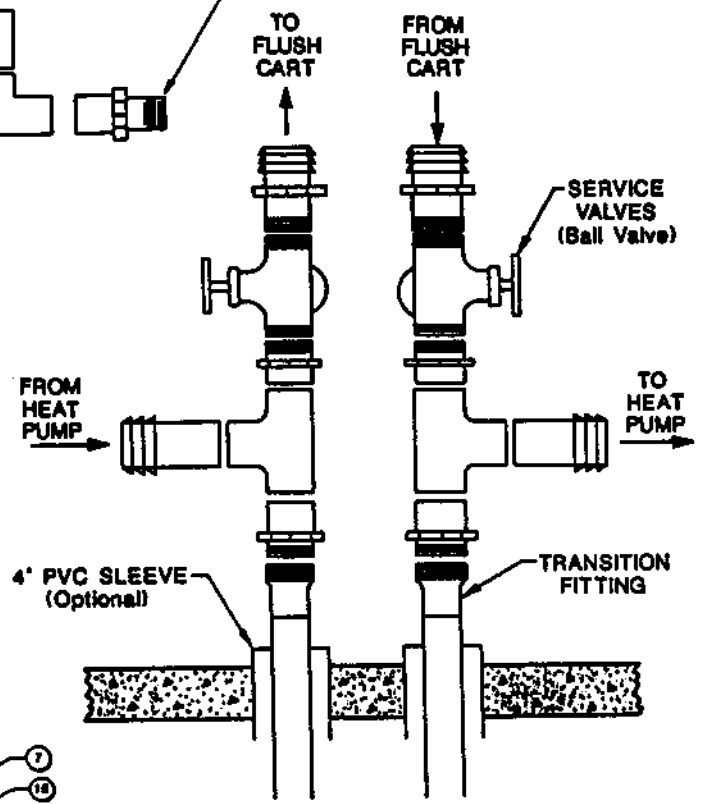

FIGURE 24

FIGURE 25



- LEGEND
- 1 - CIRCULATION PUMP
 - 2 - BALL VALVE & FLANGE
 - 7 - BARB X MIP BRASS ADAPTER
 - 11 - PETE'S PLUG
 - 14 - BARB X INSERT BRASS ADAPTER
 - 15 - BALL VALVE THREADED
 - 16 - PE TO FIT TRANSITION
 - 17 - FLEXIBLE HOSE
 - 18 - 90° STREET ELL (BRASS)
 - 20 - VISUAL FLOW METER
 - 21 - SADDLE FUSION FITTING
 - 22 - END CAP
 - 23 - PE 3408 PIPE
 - 24 - 90° ELL PE 3408
 - 25 - U-BEND PE 3408

DETAIL C

Polybutylene may also be used in place of Polyethylene pipe shown on drawings.

Drawings courtesy of Oklahoma State University.

FIGURE 27A
PUMPING SPECIFICATIONS

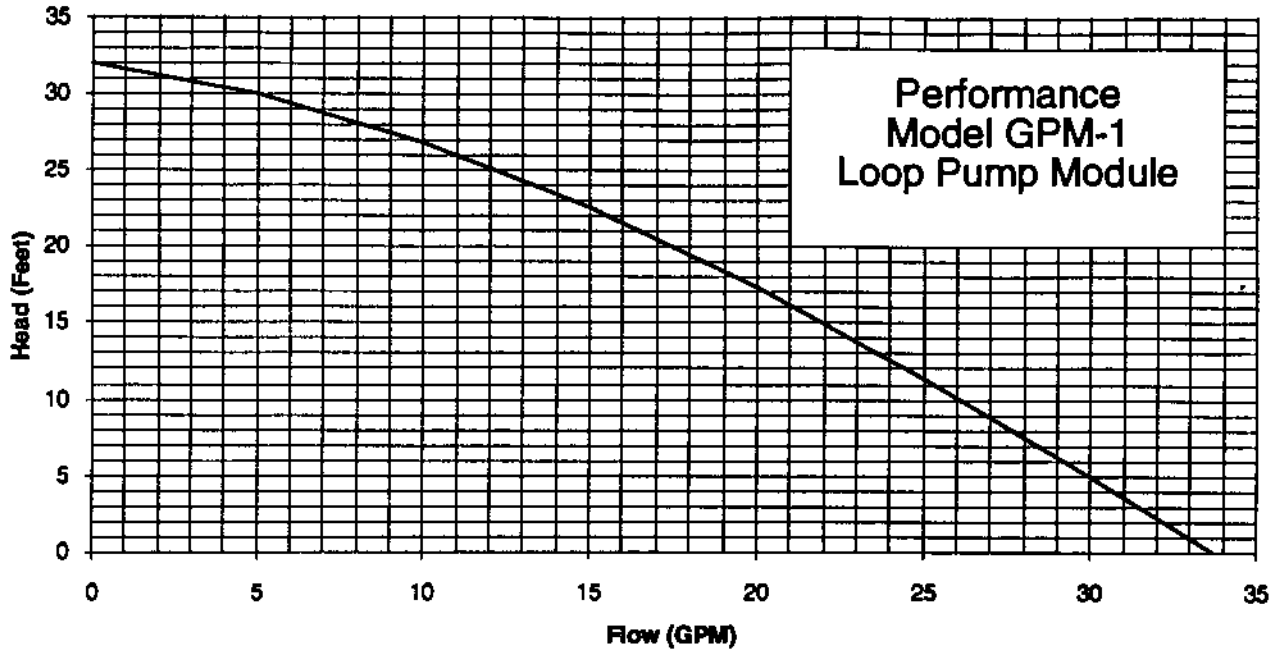

FIGURE 27B
PUMPING SPECIFICATIONS

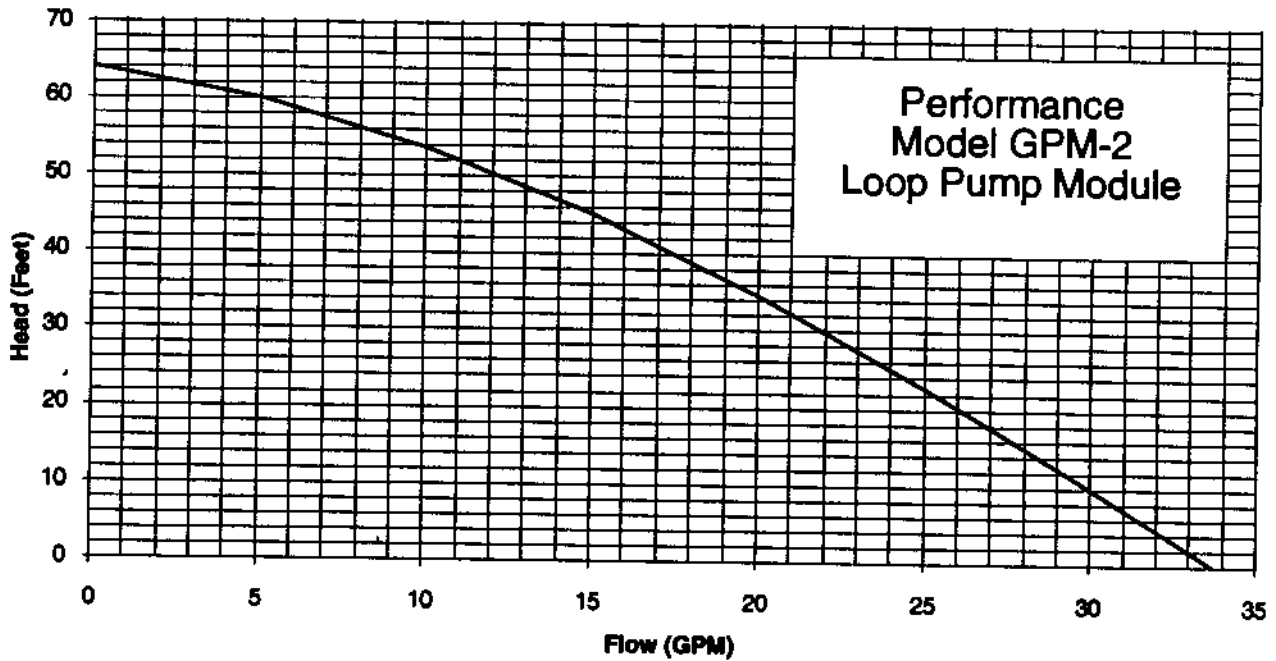

FIGURE 27
PUMP MODULE BACKUP

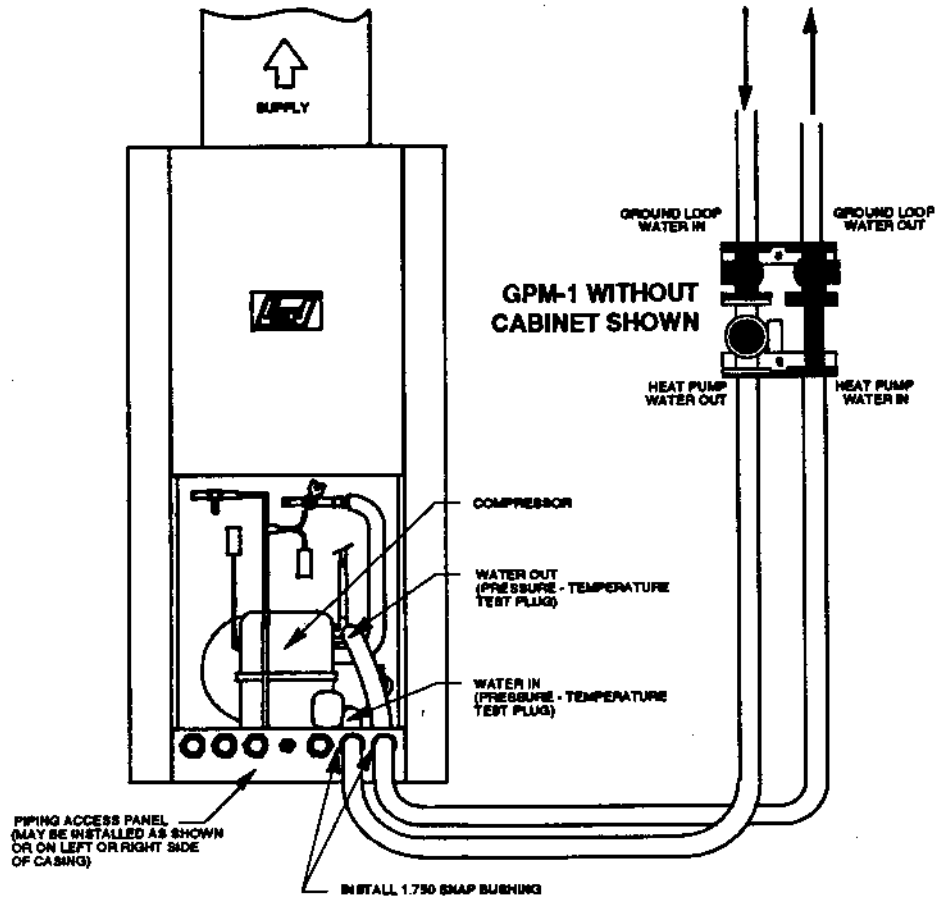
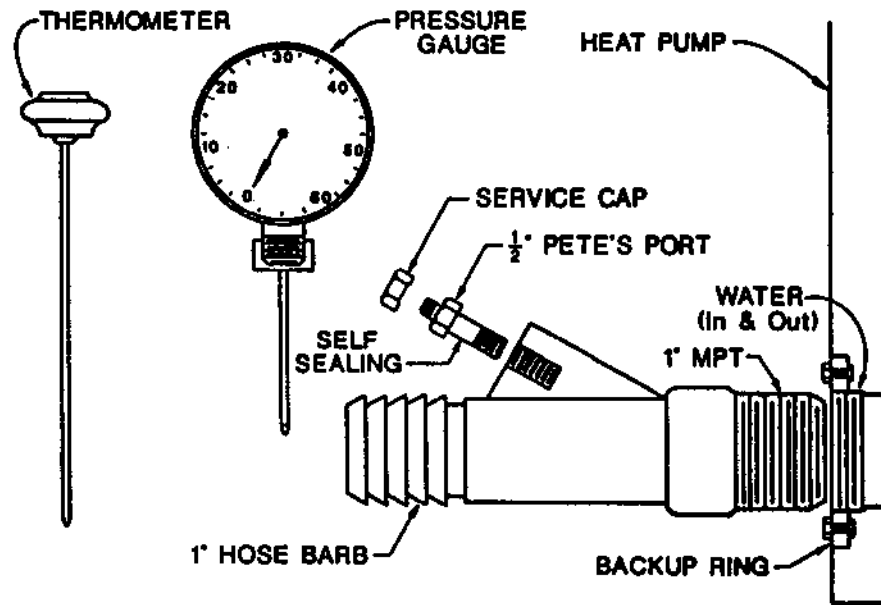

FIGURE 28
PRESSURE AND TEMPERATURE SENSING ADAPTER AND COMPONENTS



Drawings courtesy of Oklahoma State University.

PRESSURE DROP CALCULATIONS TO SELECT CIRCULATION PUMP

Transfer fluid requirements for closed-loop, earth-coupled heat pump systems varies with fluid temperature and heat pump size. To determine the circulation pump size requirement, the system flow rate requirements (GPM for heat pump used) and total system pressure drop in feet of head loss. From these two pieces of information a circulation pump can be selected from the pump manufacturer's performance curves.

The fluid (water) flow rate and water coil pressure drop are found in the manufacturer's heat pump specifications or Table 2 for Bard water source heat pumps. The head loss for different pipe materials and sizes per 100 feet are found in Table 5 of this section and a quick pump selection table for flow rates that match Bard water source heat pumps are in Table 4 of this section. See blank form F1125 in the back of this manual.

Following are two examples of how to determine the head loss of earth loops. First example will be a series horizontal system and the second example will be a parallel vertical system.

EXAMPLE 1:

- A. Series horizontal system.
- B. Bard MPV36B water source heat pump to be used.
- C. Heat pump water flow requirements is 5 GPM with a 4.6 foot head loss (see Table 3).
- D. Earth loop 1200 feet 1-1/2" SDR 17 polybutylene pipe.
- E. 20 feet 1 inch copper pipe connecting earth loop to water source heat pump.
- F. The circulation pumping system lay out to be similar to Figure 16.

CIRCULATING PUMP WORKSHEET

1. Find the Bard heat pump model used in Table 2. MODEL MPV36B

2. Enter water coil head loss (Table 2): 4.6 ft. hd.

3. Continue across Table 2 to find GPM flow required for this heat pump. 5 GPM

4. Count each elbow, tee, reducer, air scoop, flowmeter, etc., as 3 feet of pipe equivalent. Add the equivalent feet of pipe to the actual feet of pipe used. The total length is used to determine the piping head loss below.

Pipe Type and Size	No. Elbows, Tees, Devices, Etc. *	x 3	Equiv. Ft. Of Pipe	Actual Pipe Head	Total Pipe Length
1" Copper	20	x 3	60	20	80
1-1/2" PB SDR17	None	x 3	None	1200	1200
		x 3			
		x 3			
		x 3			

*If the pipe is bent at a 2 foot radius or larger, DO NOT figure the curve as an elbow.

5. PIPING HEAD LOSS for different types of pipe at GPM flow rate of water source heat pump. NOTE: For parallel earth loop system, figure for only one loop.

Pipe Type and Size	Total Pipe Length	÷	100'	Piping** Head Loss (Table 3)	
1" Copper	(80)	÷	100'	1.9	1.52 ft. hd.
1-1/2" PB SDR17	(1200)	÷	100'	0.21	2.52 ft. hd.
	()	÷	100'		ft. hd.
	()	÷	100'		ft. hd.
	()	÷	100'		ft. hd.
SUBTOTAL					8.04 ft. hd.

**For a parallel earth loop, divide the heat pump GPM (line 3) by number of loops to determine flow rate through each individual loop to select piping head loss.

6. Multiply SUBTOTAL by multiplier (see Table 5) to obtain TOTAL HEAD LOSS FOR SYSTEM using antifreeze solution. TOTAL HEAD LOSS 11.75 ft. hd.

7. PUMP SELECTION: Use Table 4 and flow rate, (line 3). Select the pump output which is larger or equal to the TOTAL HEAD LOSS FOR SYSTEM (line 5 or 6). 24 - 64 Circulating Pump Model No. Pump

If the TOTAL HEAD LOSS calculated in line 6 is greater than the pump outputs listed in Table 4, go to the pump manufacturer's performance curves and find the required GPM flow for the heat pump. Pump performances are listed for each pump model at different flow rates.

Series pump performance is simply a TOTAL OF THE INDIVIDUAL PUMP PERFORMANCES. If one pump can overcome 10 feet of head loss, two can overcome 20 feet of head loss, three can overcome 30 feet of head loss, etc.

***** REMEMBER: UNDER NO CIRCUMSTANCES MIX DIFFERENT PUMP SIZES WHEN USING PUMPS IN SERIES. *****

F1125-090

TABLE 2 WATER COIL PRESSURE DROP

Model	WQS30A	WQS36A	Model	WQS42A	WPV62B
	WPV30B	WPV36B		WPV53B	
GPM	Feet Head	Feet Head	GPM	Feet Head	Feet Head
4	4.6	4.4	6	5.8	5.8
5	6.9	4.6	7	7.4	8.1
6	10.0	5.5	8	9.2	10.4
7	13.1	6.9	9	12.0	12.9
8	17.3	9.0	10	15.0	15.5
9	21.9	12.7	11	17.8	18.5
10	27.7	17.5	12	20.8	21.5
11	34.1	24.0	13	24.2	24.7
12	40.6	35.3	14	27.7	28.4
13	46.8	47.5			

TABLE 4 SELECTION OF CIRCULATION PUMP OR PUMPS

Pump Output (Feet of Head) @ GPM @ Top Of Column	Grundfos* Pump Models	No. Pumps	Water Flow Rate Required in G.P.M.						
			4	6	8	10	12	14	16
Loop Pump Models	UP26-96F	1	26.5	25	22.5	20	18	16	14
	UP26-96F	2	53	50	45	40	36	32	28
	UP26-99F	1	30.5	29	28	27	25	23.5	22
	UP26-99F	2	61	58	56	54	50	47	44
GPM-1**			28.5	27	25	23	21	18.5	
			57	54	50	46	42	37	

*Other models of circulation pumps may be used. Consult the manufacturer's specifications

**See manual 2100-212 GPM series loop pump modules for complete details

TABLE 3 MINIMUM FLOW IN PIPE FOR TURBULANCE (GPM)*

Nominal Pipe Size (Pipe ID)	Water at 40 deg F	Cryotech	Noburst	Propylene
		GS4 27% Volume 25 deg F	30% Volume 25 deg F	Glycol 23% Vol. 25 deg F
PE (SDR-11)				
3/4" (0.86)	1.1	1.9	3.1	3.5
1" (1.077)	1.3	2.4	3.9	4.5
1-1/4" (1.385)	1.7	3.0	5.0	5.6
1-1/2" (1.554)	1.9	3.5	5.7	6.4
2" (1.943)	2.4	4.3	7.0	8.0
PE (SCH 40)				
3/4" (0.824)	1.0	1.9	3.0	3.4
1" (1.049)	1.3	2.4	3.8	4.3
1-1/4" (1.380)	1.7	3.1	5.0	5.7
1-1/2" (1.610)	2.0	3.6	5.8	6.6
2" (2.067)	2.5	4.6	7.6	8.5
PB(SDR-17,IPS)				
1-1/2" (1.676)	2.1	3.7	6.0	6.9
2" (2.095)	2.6	4.6	7.6	8.6
PB(SDR-13.5,CTS)				
1" (0.957)	1.2	2.1	3.5	4.0
1-1/4" (1.171)	1.4	2.6	4.3	4.8
1-1/2" (1.385)	1.7	3.1	5.0	5.7
2" (1.811)	2.2	4.0	6.6	7.4

*For each separate loop.

NOTE: When selecting pipe size for parallel flow, it is necessary to maintain turbulent flow in the earth coil for heat transfer. The table above lists the minimum flows for turbulence.

TABLE 5 PIPING FEET OF HEAD LOSS AT DIFFERENT FLOW RATES PER 100 FEET

Pipe Size and Material	G.P.M. FLOW RATE										
	DI	1	2	3	4	5	6	8	10	12	14
Connection Hose 1"	1.050	*	*	*	1.33	1.95	2.68	4.43	6.53	8.99	11.77
PVC 3/4" - 200 PSI		*	*	*	3.7	5.7	*	*	*	*	*
PVC 1" - 200 PSI		*	*	*	1.0	1.9	2.7	4.2	6.3	8.9	11.8
Copper 3/4"		*	*	*	4.3	6.3	*	*	*	*	*
Copper 1"		*	*	*	1.5	1.9	2.7	4.5	6.9	9.6	12.8
PE3408 (Polyethylene)											
	DI										
1. SDR-11 3/4	0.860	0.31	1.03	2.07	3.41	5.03	*	*	*	*	*
2. SDR-11 1	1.077	0.11	0.36	0.71	1.18	1.73	2.38	3.92	*	*	*
3. SDR-11 1-1/4	1.358	*	0.12	0.24	0.39	0.58	0.79	1.31	1.93	2.65	3.47
4. SDR-11 1-1/2	1.554	*	*	0.13	0.21	0.31	0.42	0.69	1.02	1.40	1.83
5. SDR-11 2	1.943	*	*	*	0.07	0.11	0.15	0.24	0.35	0.48	0.63
6. SCH 40 3/4	0.824	0.38	1.26	2.54	4.18	6.16	8.46	*	*	*	*
7. SCH 40 1	1.049	0.12	0.40	0.81	1.33	1.96	2.69	4.45	*	*	*
8. SCH 40 1-1/4	1.380	*	0.11	0.22	0.36	0.54	0.74	1.21	1.79	2.46	3.21
9. SCH 40 1-1/2	1.610	*	*	0.11	0.18	0.26	0.35	0.58	0.86	1.18	1.55
10. SCH 40 2	2.067	*	*	*	*	0.08	0.11	0.18	0.26	0.36	0.47
PB2110 (Polybutylene)											
	DI										
11. SDR-17, IPS 1-1/2	1.676	*	*	0.09	0.15	0.21	0.29	0.48	0.71	0.98	1.28
12. SDR-17, IPS 2	2.095	*	*	*	0.05	0.07	0.10	0.17	0.25	0.34	0.44
13. SDR-13.5, Cts 1	0.957	0.19	0.62	1.25	2.06	3.03	4.16	*	*	*	*
14. SDR-13.5, Cts 1-1/4	1.171	*	0.24	0.48	0.79	1.17	1.60	2.64	*	*	*
15. SDR-13.5, Cts 1-1/2	1.385	*	0.11	0.22	0.36	0.53	0.72	1.19	1.76	2.41	3.2
16. SDR-13.5, Cts 2	1.811	*	*	0.06	0.10	0.15	0.20	0.33	0.49	0.68	0.88

- NOTES: 1. These head losses are for water at 40 degrees F temperature.
 2. Count each elbow, tee, reducer, air scoop, flow meter, etc., as 3 feet of equivalent pipe length and add to actual measured pipe length for total length.
 3. To adjust the total earth loop piping head loss for other antifreezes and water solutions at 25 degrees F, multiply pressure loss on line 6 for water by:
 Propylene Glycol - 1.38, Noburst - 1.33, Cryotech GS4 - 1.17

EXAMPLE 2:

Given:

- A. Vertical system.
- B. Bard WPV53A water source heat pump.
- C. Heat pump water flow requirements are 10 GPM with a 15 foot head loss (see Tables 2 and 3).
- D. Heat pump connected to circulation pump module and earth coil with 25 feet of 1 inch I.D. connection hose.
- E. Pressure drop through flow meter and connections to coil of water source heat pump 1 inch copper.
- F. Three loops (U-bends) with 373 feet pipe each.
- G. Loops are 3/4 inch SDR-11 polyethylene pipe.
- H. Flow rate through each loop will be 1/3 of total flow through total earth loop system because there are three loops and each one will have an equal share of the total flow rate.

$$10 \text{ GPM} \div 3 = 3.3 \text{ GPM per loop}$$

- I. 240 feet of 1-1/2 inch SDR-11 polyethylene pipe headers.

CIRCULATING PUMP WORKSHEET

1. Find the Bard heat pump model used in Table 2. MODEL WPV53A
2. Enter water coil head loss (Table 2): 15 ft. hd.
3. Continue across Table 2 to find GPM flow required for this heat pump. 10 GPM
4. Count each elbow, tee, reducer, air scoop, flowmeter, etc., as 3 feet of pipe equivalent. Add the equivalent feet of pipe to the actual feet of pipe used. The total length is used to determine the piping head loss below.

Pipe Type and Size	No. Elbows, Tees, Devices, Etc. *	x 3	Equiv. Ft. Of Pipe	Actual Pipe Used	Total Pipe Length
1" Buna	NA	x 3	NA	25	25
1" Copper	11	x 3	33	10	58
PE SDR-11 3/4"	4	x 3	12	373	385
PE SDR-11 1-1/2"	8	x 3	24	240	264
		x 3			

*If the pipe is bent at a 2 foot radius or larger, DO NOT figure the curve as an elbow.

5. PIPING HEAD LOSS for different types of pipe at GPM flow rate of water source heat pump. NOTE: For parallel earth loop system, figure for only one loop.

Pipe Type and Size	Total Pipe Length	Footing** Head Loss (Table 3)	
1" Buna	(25)	100'	1.63 ft. hd.
1" Copper	(58)	100'	3.59 ft. hd.
PE SDR-11 3/4"	(385)	100'	7.97 ft. hd.
PE SDR-11 1-1/2"	(264)	100'	2.69 ft. hd.
	()	100'	ft. hd.

For a parallel earth loops, divide the heat pump GPM (line 3) by number of loops to determine flow rate through each individual loop to select piping head loss. **SUBTOTAL 30.88 ft. hd.

6. Multiply SUBTOTAL by multiplier (see Table 5) to obtain TOTAL HEAD LOSS FOR SYSTEM using antifreeze solution. **TOTAL HEAD LOSS** 42.0 ft. hd.

7. PUMP SELECTION: Run Table 4 and flow rate, (line 3). Select the pump output which is larger or equal to the TOTAL HEAD LOSS FOR SYSTEM (line 5 or 6). 26 - 96 2
Circulating Pump Model No. Pumps

If the TOTAL HEAD LOSS calculated in line 6 is greater than the pump outputs listed in Table 4, go to the pump manufacturer's performance curves and find the required GPM flow for the heat pump. Pump performances are listed for each pump model at different flow rates.

Series pump performance is simply a TOTAL OF TEN INDIVIDUAL PUMP PERFORMANCES. If one pump can overcome 10 feet of head loss, two can overcome 20 feet of head loss, three can overcome 30 feet of head loss, etc.

***** REMEMBER: NEVER MIX DIFFERENT PUMP SIZES WHEN USING PUMPS IN SERIES. ***** F1125-890

STANDARDIZED PARALLEL SYSTEM HEADER DESIGN

The advantages of a standardized parallel header design for ground heat exchanger from one ton of heat pump capacity and up are:

1. All parallel path connections (saddle fusions) are premanufactured and drilled out prior to arrival at the field site. Therefore, quality control is improved.
2. Only a minimum number of field-fabricated butt joints are required.
3. The header design minimizes the water flow rate required for air purging.

The design recommendations are as follows:

1. The design assumes that one loop will be used for each ton of heat pump capacity and that the nominal heat pump operating water flow rate will be a 3 GPM/ton.
2. The maximum recommended bore hole depths or length of horizontal pipe loops are:
 - A. 250 feet using 3/4 inch SDR-11 polyethylene pipe or 1 inch SDR-13.5 cts polybutylene pipe.
 - B. 400 feet using 1 inch SDR-11 polyethylene pipe or one 1/4 inch SDR-13.5 cts polybutylene pipe.

In all cases, the specific fluid used and the recommended lower operating temperature will determine the pipe diameter and length. For bore holes greater than this depth, larger diameter pipe is required and a detailed analysis must be made.

3. One-ton ground heat exchangers will be of the series type. They will be fabricated from either 3/4- or 1 inch SDR-11 polyethylene pipe, or 1 or 1-1/4 inch SDR-13.5 cts polybutylene pipe.
4. Two-ton ground heat exchangers are fabricated from 1 inch SCH 40 polyethylene header pipes and 3/4 or 1 inch SDR-11 pipe loops, or 1-1/4 inch header pipes and 1 inch SDR-13.5 polybutylene pipe.
5. The basic design module for ground heat exchangers for three tons and higher is the 3 ton preassembled unit shown in Figure 31A. The unit is shown butt fused for polyethylene pipe, but can also be socket fused with appropriate socket fittings using polybutylene pipe.

This unit is premanufactured and preassembled. It consists of one 1-1/2 x 3/4 inch bell reducer, two 3/4 inch tees, and one 90° elbow. If the loop water pressure drop becomes excessive, the 3/4 inch pipe size can be replaced with 1 inch pipe for bore holes greater than 200 feet in depth.

Since 3/4 inch SDR-11 (1.077 inch ID) polyethylene pipe and 1 inch SDR-13.5 cts (0.957 inch ID) polybutylene pipe have approximately the same internal diameter, it is necessary to use the larger sized polybutylene pipe to have the same fluid pressure drop.

The bell reducer shown in Figure 31A is used to prevent any trapped air at the end of the header pipe. By using 2 tees and the 90° elbow at the bell reducer end, the fluid flow required for air purging in the 1-1/2 inch header section is 12.7 GPM.

6. Heat exchangers up to 7 tons can be constructed by adding the required number of parallel adapters or reducing tees (polybutylene pipe) to the basic 3 ton heat exchanger unit (see Figure 31A). Table 2 summarizes the required components necessary for heat exchangers in the range of 1 to 10 tons.
7. For heat exchanger sizes above 7 tons, additional parallel adapters or reducing tees fabricated from 2 inch header pipe and 3/4 or 1 inch service saddles are added as shown in Figure 31B. Heat exchangers from 7 to 10 tons should use 2 inch main header pipe and 1-1/2 inch subheader pipe.

Above 10 tons, the ground heat exchangers described above should be installed in parallel to give the required capacity.

For ground heat exchangers of less than 10 tons, remove the service saddles from left to right as shown in Figure 31B. For example, a 7 ton heat exchanger would consist of the basic 3 ton module plus the 4 service saddles on the 1-1/2 inch header pipe. The spacing between the service saddles on the 2 and 1-1/2 inch headers is optional. That is, the flushing flow rate or the operating pressure heads are not affected greatly.

Do not space the 3/4 inch tees and 90° elbow. Spacing these components can result in excessive pressure loss and unequal flow in the loops connected to the 3 ton module.

If it is necessary to space the tees and elbow, refer to Figure 10A for recommended methods.

Do not space the 3/4 inch tees and 90° elbow more than two feet apart. This can result in excessive pressure loss and unequal flow in the loops connected to the 3 ton module.
--

1. The required flushing flow rate for this header design and loop system equals:

$$4.25 \text{ GPM} \times \text{number of tons}$$

2. The flushing head required equals:

$$\text{Header pressure loss} + \text{loop pressure loss}$$

FIGURE 31A
 THREE-TON HEADER DESIGN FOR POLYETHYLENE (BUTT FUSED)
 OR POLYBUTYLENE (SOCKET FUSED)

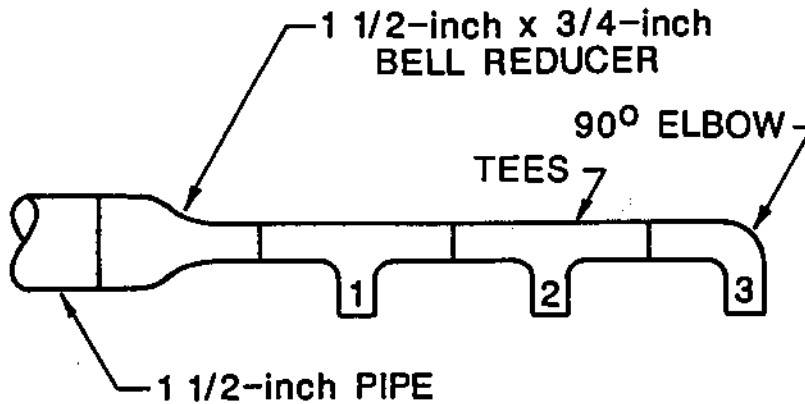
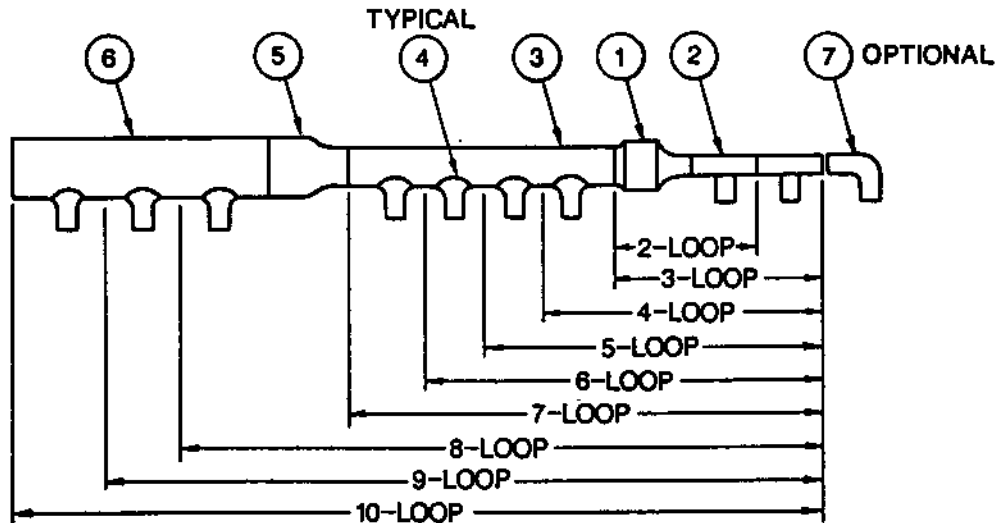

FIGURE 31B
 TEN-TON HEADER SYSTEM--PE PIPE--BUTT FUSED



ITEM	SIZE AND DESCRIPTION
1	REDUCER, 1 1/2- OR 1 1/4-INCH X 1- OR 3/4-INCH
2	TEES, 1- OR 3/4-INCH
3	PIPE, 1 1/2- OR 1 1/4-INCH
4	STRAIGHT OUTLET SERVICE SADDLES OUTLETS, 1-INCH OR 3/4-INCH
5	REDUCER, 2-INCH X 1 1/2-INCH
6	PIPE, 1-INCH
7	ELBOW, 1- OR 3/4-INCH ON ANY OUTLETS (OPTIONAL)

**TABLE 5A
REQUIRED HEAT EXCHANGER COMPONENTS**

Box Size (Tons)	Parallel Adapters or Tees	Tees (Loop Size)	Bell Reducers 1-1/2 x 3/4	Elbows (Optional) 3/4 inch
1	Series system recommended, 3/4 or 1 inch pipe			
2	Parallel system, 1 inch headers, 3/4 inch loops A. Two 1 x 3/4 inch bell reducers B. Two 3/4 inch tees C. Two 90° elbows			
3	--	4	2	2
4	2	4	2	2
5	4	4	2	2
6	6	4	2	2
7(1)	8	4	4(2)	2
8(3)	10(4)	4	4(2)	2
9	12(4)	4	4(2)	2
10	14(4)	4	4(2)	2
<p>(1) If the supply and return headers exceed 200 feet, a 2 inch header should be used.</p> <p>(2) Use 2 each 2 inches by 1-1/2 inches; 2 each 1-1/2 inches by 3/4 inch.</p> <p>(3) Use 2 inch supply and return headers up to the subheaders for all ground heat exchangers from 7 tons to 10 tons.</p> <p>(4) Use 10 each 1-1/2 inch by 3/4 inch parallel adapters. The remaining parallel adapters or reducing tees will be 2 inches by 3/4 inch.</p>				

VII. FREEZE PROTECTION

Antifreeze solutions used in earth loop systems must be non toxic and non corrosive. Non toxic in case there is a leak in the loop system so the ground water will not be contaminated and non corrosive to protect the metal components used in the circulation pumps and other system components.

CRITERIA FOR ANTIFREEZE

1. Safe
2. Non-toxic
3. Non-corrosive
4. Good heat transfer medium
5. Low cost
6. Long lasting

ANTIFREEZE SOLUTIONS--Except in the very most southern climates, an antifreeze solution will be required to prevent freezing in the heat pump heat exchanger. The choices are as follows:

1. Salts--Calcium Chloride and Sodium Chloride
2. Glycols--Ethylene and Propylene
3. Alcohols--Methyl, Isopropyl, and Ethyl
4. Potassium Acetate and Carbonate

The selection of an earth coil circulation fluid is based upon the following:

1. Safety (toxicity and flammability)
2. Freezing point
3. Heat transfer characteristics (primarily thermal conductivity and viscosity)
4. Frictional pressure drop and pumping requirements (primarily viscosity)
5. Cost (initial charge, makeup and inhibitor costs)
6. Corrosiveness
7. Physical and chemical compatibility with all system components
8. Availability of product in local market area
9. Ease of transporting and storing
10. Codes/state and local

ADVANTAGES AND DISADVANTAGES OF EACH CIRCULATION FLUID

1. Water

A. Advantages

1. Least expensive and most readily available
2. Low viscosity and high thermal conductivity
3. Low frictional pressure drops
4. High heat transfer coefficients

Disadvantages of using water as an antifreeze solution

1. Water has a relatively high freezing point of 32°F
2. Water expands upon freezing

2. Salts

A. Sodium Chloride in water advantagea

1. Lowest brine cost per gallon
2. Low viscosity and high thermal conductivity
3. Low toxicity
4. Low volatility and are not flammable

Disadvantages of Sodium Chloride in water

1. Freezing point depression is moderate
2. Very corrosive and require inhibitors

B. Calcium Chloride in water

1. Greater freezing point depression than sodium chloride
2. Low viscosity and high thermal conductivity
3. Very corrosive

For successful operation of salt brine solutions, the following should be observed:

- A. All air must be purged or removed. Fluid velocities greater than 2 feet per second must be achieved.
 - B. Air traps at the end of headers and manifolds must be eliminated.
 - C. Metal components with a high zinc content must be eliminated.
 - D. Copper-nickel heat exchangers are desirable.
 - E. Dissimilar metal connections should be avoided.
 - F. If system is drained, flush thoroughly at once.
- SALT SOLUTIONS ARE NOT RECOMMENDED. USE MAY VOID FACTORY WARRANTIES.**

3. Glycols

A. Ethylene Glycol in water

1. Aqueous ethylene glycol solutions are relatively non-corrosive
2. Relatively low volatilities and present a low flammability hazard

Disadvantages of Ethylene Glycol in water

1. Somewhat toxic
2. High viscosity at low temperatures

B. Propylene Glycol in water

1. Lower toxicity than ethylene glycol
2. Low corrosivity
3. Low volatility and low flammability
4. High viscosity at low temperatures

4. Alcohols

A. Methyl Alcohol (Methanol) in water

1. Low cost
2. Low corrosivity
3. Low viscosity
4. Good thermal conductivity

Disadvantages of using Methanol

1. High volatility
2. High flammability
3. High toxicity

B. Ethyl Alcohol in water

1. Less toxic and less flammable than methanol waters
2. Highly flammable and requires careful handling and storage
3. More viscous than methyl alcohol solutions
4. Larger frictional pressure drops and lower heat transfer coefficients when compared to methyl alcohol mixtures

5. Potassium Acetate in water

- A. Safer to use--very low toxicity
- B. Safer for the environment--biodegrades naturally
- C. Safer to handle--completely non-flammable
- D. Outstanding performance--superb viscosity at lower temperatures and excellent corrosion properties

The earth coil circulation fluid freezing point is particularly important and determines the solute concentration in the circulation fluid that is required for freeze protection of the evaporator of the heat pump. The coldest expected evaporator exit temperature of the earth coil circulation fluid during heating operation determines the required freezing point of the circulation fluid. The refrigerant temperature in the evaporator runs approximately 10°F lower than the exit water temperature, therefore, it is necessary to provide freeze protection for the minimum operating evaporator refrigerant temperature.

Generally speaking, the salts are safe, non toxic, have good heat transfer characteristics, are low cost, have long life but are corrosive in the presence of air and most metals. The major drawback of the salts is their very corrosive nature and their cleanup problems when spilled. One very strong point is that they are considered non toxic and environmentally safe. With proper metal component selection and air purging of the system, they can and have been used successfully. In northern climates where heat pump loop operating temperatures go as low as 25°F, calcium chloride, potassium acetate (GS4) and methanol has been used.

Glycols are safe, are considered toxic, are generally non corrosive, have fair heat transfer characteristic, are medium cost and with a finite life. For low temperature operation, the glycols can become viscous requiring greater pumping power and, therefore, reduce the heat pump system efficiency.

Improperly handled, alcohols are not safe (burn and explode when mixed with air), are toxic, are relatively non corrosive, with fair heat transfer characteristics, are medium cost, and have long life. Their major drawbacks are their explosive and toxic behavior. Diluting the alcohol solution before taking them on site reduces the explosive risk somewhat. Alcohols are non corrosive which makes their use very popular. Their application has been in both the northern and southern climates.

CAUTION: Many anti corrosion inhibitors are toxic and care must be taken to prevent a non toxic antifreeze solution from becoming toxic after the solution is inhibited.

METAL COMPONENTS--The metal components in the system must be compatible with the cl/gc circulating fluid. The components that must be carefully selected are:

1. Circulation pump and pump flanges
2. All metal piping
3. Sensing ports
4. Any metal components in contact with the circulating fluid

Depending on the antifreeze selected, the metals chosen for the system must be carefully selected. The dealer's recommendation must be carefully followed.

To determine the amount of antifreeze to be added to the water in the earth loop, calculate the approximate volume of water in the system by using the following table which gives the gallons of water per 100 feet of pipe.

<p>NOTE: When local ground water temperature is below 60°F and loop is designed for heating load, Bard recommends designing for minimum loop temperature of 15°F leaving heat pump</p>

TABLE 6

Pipe Material		Nominal Pipe Size	Gallons Per 100' of Pipe
Polyethylene	SDR-11	3/4	3.02
	SDR-11	1	4.73
	SDR-11	1-1/4	7.52
	SDR-11	1-1/2	9.85
	SDR-11	2	15.40
	SCH 40	3/4	2.77
	SCH 40	1	4.49
	SCH 40	1-1/4	7.77
	SCH 40	1-1/2	10.58
Polybutylene	SDR-17 IPS	1-1/2	11.46
	SDR-17 IPS	2	17.91
	SDR-13.5 CTS	1	3.74
	SDR-13.5 CTS	1-1/4	5.59
	SDR-13.5 CTS	1-1/2	7.83
	SDR-13.5 CTS	2	13.38
	Copper	1	4.3

Add two gallons for equipment room devices and heat pump.

THE MOST COMMONLY USED ANTIFREEZE MATERIALS

PROPYLENE GLYCOL (NOT A GOOD CHOICE FOR PARALLEL LOOP SYSTEMS)

Propylene glycol solution is lower in toxicity, can offer low corrosivity, low volatility, and low flammability hazard. However, propylene glycol is more costly and yields more viscous solutions. Propylene glycol solutions may be considered for use down to about 15°F. Use of propylene glycol solutions below 15°F offers excess viscosity which, in turn, yields excessively high frictional pressure drops and excessively low heat transfer coefficients.

The 15°F temperature is definitely the maximum lower limit for closed loop systems. A more reasonable lower limit threshold would be a maximum 25% mixture by volume and operating above 30°F. Lower operating temperatures and/or higher concentrations of propylene glycol are not economical when you consider the energy required to pump the fluid and maintain turbulent flow under those conditions.

In order to obtain good heat transfer within the buried pipe system, the calculated Reynolds number should not fall below 2500 for the coldest exit fluid temperature from the heat pump.

The quality of the water used to prepare glycol solutions is important. The water should be "soft" and have a low concentration of chloride and sulfate ions. Glycol inhibitor is commonly added by the manufacturer. Glycol solutions normally have a pH of 8.8 to 9.2. Glycol solutions having pH that falls below 7.5 should be replaced. Addition of inhibitor cannot restore the solution. Indiscriminate mixing of differently inhibited solutions should be avoided unless the solutions are known to be compatible.

Never use chromite treatment because it will result in rapid buildup of sludge. Glycol solutions, even though inhibited, do not have an indefinite service life and should be checked yearly. Spent glycol solution should be removed from the system and replaced with fresh glycol solution.

Where the ground water at 100 foot depth is less than or equal to 60°F, a 20% by volume solution of propylene glycol is required. The percentage of antifreeze depends on geographical location. A 25% by volume solution of propylene glycol is required for 15°F freeze protection.

NOTE: There are many antifreeze heat transfer fluids that use propylene glycol as the main antifreeze ingredient. Be sure to use the manufacturer's instructions for handling and percent of mixture to protect the system down to 15°F.

NOBURST (PROPYLENE GLYCOL HEATER TRANSFER FLUID)

Product Description

Noburst is a non-toxic antifreeze and heat transfer fluid. The product is to be used in place of water and other water-like fluids in systems where freezing may either cause damage or interfere with the functioning of systems of equipment and/or toxicity to humans or animals is a concern. Noburst is safe for use in contact or potential contact with potable water.

INGREDIENTS:

Active Ingredient: Propylene Glycol
Corrosion Inhibitor: Dipotassium Phosphate
Other Ingredients: Viscosity reduction agent
Food, Drug, and Cosmetic Grade red dye
Water

COLOR: Reddish/pink

TOXICOLOGICAL, ENVIRONMENTAL, AND HEALTH INFORMATION:

- Casselin Toxicity Index (Propylene Glycol): 1 "essentially non-toxic"
- Mean Single Lethal (Oral) Dosage: greater than one liter

FDA REFERENCE:

- Propylene Glycol: 21 CFR 182.1666
 - Dipotassium Phosphate: 21 CFR 182.6285
- Both quality as "General Recognized as Safe for use as Direct Food Additives"

FLAMMABILITY:

Noburst is not flammable since it has no measurable flashpoint; however, if the product comes in extended contact with open flame, it is possible it will ignite.

FUMES: Non-hazardous

ENVIRONMENTAL HAZARD:

Low, Noburst is not toxic to animals or plants. Spills may generally be disposed of through city sewer; however, local sewer authorities should be contacted prior to disposal. Large spills, uncontrolled disposal, and waterway discharge should be avoided since Noburst biodegrades rapidly, possibly depleting oxygen supply in bodies of water which can result in fish kill. All uncontrolled spills should be reported to local authorities.

CAUTIONS:

- Noburst will remove zinc from galvanized materials, consequently contact with galvanized materials should be minimized. Systems constructed of aluminum will also experience corrosion with Noburst, particularly if high temperatures are expected. All other common metals are protected from corrosion with Noburst.
- Noburst should not be used with other water treatment chemicals. The Noble Company cannot test all possible combinations of chemicals for compatibility and proper performance. A well maintained loop system using Noburst should not require other treatment chemicals.

INSTALLATION:

No matter what type of system or equipment Noburst is to be used in, several key steps are the same:

1. Clean the system. Minerals, scale, rust, and sediment can all shorten the life of your system, reduce Noburst's effectiveness, and reduce energy efficiency.

Drain the system completely. Flush with clean fresh water, add Noburst Precleaner, 1 pint for every 50 gallons of system capacity, and run system up to operating temperature. Allow Precleaner to circulate for approximately 24 hours. Drain and flush with water.

Paradoxically, new systems are usually dirtier than currently operating systems since during construction solder, flux, grease, and other foreign materials often get into the piping. Thus, thorough cleaning is even more important on new systems.

Further, systems that have had another non-water fluid in it, such as ethylene glycol, should be cleaned particularly well so as to avoid contamination of the Noburst with other fluid. In both cases, allow precleaner to circulate for 24 hours to 1 week.

Check the system for leaks and repair any that are found. (Noburst may seep by some mechanical connections which are water tight. Inspect and tighten these connections if necessary.)

2. Measure total fluid capacity of the system including piping, headers, pumps and MSRP water coil.

Piping fluid capacity may be estimated using the pipe capacity chart in this manual. Capacity must be obtained from the manufacturer of the specific pieces of equipment in system. Be sure all piping is accounted for in your estimates.

3. Determine low temperature protection needed and corresponding Noburst concentration to use. Calculate number of gallons of Noburst to add to system. Allow for estimating errors when determining amount of Noburst to use.

4. Make sure the system is flushed and full of clean water. See section "System Start Up" and "Adding Antifreeze".

5. Get all the air out of the system. Oxygen is required for corrosion to occur, so the less oxygen present, the better the corrosion resistance. Air can also reduce circulation, waste energy, and cause noise.

Air is entrapped in water and other fluids and only comes out with time, so several ventings or purgings may be necessary to have a truly airless system.

6. Test the fluid after installation and thorough mixing to insure that the proper amount of Noburst is present. Use only Noburst Test Strips for the testing.

Recommended Concentrations

Various types of fluid systems require varying amounts of Noburst to satisfy their specific requirements. Here are the minimums:

Ground-Water and Earth-Coupled Heat Pumps: Generally, antifreeze is used in these types of systems to allow fluid flow down to +15 to +20°F. Burst protection and other factors are quite secondary. In this case, use 30% Noburst.

Maintenance

Systems with Noburst installed should be tested at least annually for adequate Noburst concentration and corrosion inhibitor protection level. If Noburst concentration is low, add Noburst according to this formula:

$$\frac{\text{System Capacity (gals)} \times (\% \text{ Noburst desired} - \% \text{ Noburst now have})}{100\% - \% \text{ Noburst now have}}$$

Before adding additional Noburst, drain adequate fluid from the system so that when the new Noburst is added, the operating pressure will not be too high.

If the corrosion inhibitor test low, add one pint of Noburst Inhibitor Boost per 20 gallons of fluid capacity of the system. If the total system capacity is less than 20 gallons use one pint. If after Inhibitor Boost addition and thorough system mixing the corrosion inhibitor still tests low, add another pint per 20 gallons system capacity. If after this addition the inhibitor still tests low, the system has been contaminated with minerals or an acidic chemical. The system should be drained, cleaned, and recharged with Noburst.

Technical Support

The Noble Company
Post Office Box 332
614 Monroe Street
Grand Haven, Michigan 49417
Phone: 616-842-7844
Fax: 616-842-1547

METHYL ALCOHOL (METHANOL)--Not Recommended By Bard

Methyl alcohol, sometimes referred to as methanol, wood alcohol and carbinol has been widely used as an antifreeze. Methanol water offers low cost, low corrosivity, low viscosity, and good thermal conductivity. Methanol water offers relatively low frictional pressure drops and relatively high heat transfer coefficients. Methanol, however, offers the disadvantages of high volatility, high flammability, and high toxicity. Pure methanol has a flash point of 54°F to 60°F, while a 30% methanol in water solution has a flash point of 75°F. These flash points are poor. A 20% by volume solution will have a freezing point of 15°F.

POTASSIUM ACETATE (GS4™)

GS4 is an environmentally safe heat transfer fluid to replace methanol in ground source heat pump installations. It is a proprietary formula of potassium acetate specifically designed to meet the environmental and performance needs of the ground source heat pump industry.

GS4 DESCRIPTION:

- GS4 is a transparent green liquid. It is made of potassium and acetate.
- Acetate is the primary ingredient in vinegar.
- Acetate is the most abundant organic acid metabolite found in nature. Acetate is formed in soils by decomposition of plant matter (e.g., leaves will decompose to acetate).
- Potassium is found in many foods and is a necessary human nutrient.
- Potassium acetate is used as a diuretic drug.

GS4 Heat Transfer Fluid should not be taken internally. Contact with human tissue should be avoided.

Environmental Impacts

GS4 LOW TOXICITY:

Toxicity tests show that GS4 is considered practically non-toxic. It is less toxic to mammals than table salt. In the unlikely event that GS4 gets into a drinking water, the threat to human health is very small.

ACETATE READILY BIODEGRADES:

Acetate biodegrades in the soil, in the ground water, and in surface water (ie., lakes and streams). Bacteria found in water and soil convert the acetate to naturally occurring products: carbon dioxide, water, and bicarbonate.

The biodegradation process takes anywhere from a few days to a few weeks depending on conditions.

POTASSIUM WILL QUICKLY DILUTE:

Potassium is very soluble in water. This property allows it to diffuse into the ground water and become dilute.

POTASSIUM IS USED TO FEED PLANTS:

- Some of the potassium will be taken up by plants. The "unused" potassium will attach itself to the soil.
- GS4 is considered relatively harmless to daphnia and rainbow trout under generally recognized criteria for acute aquatic toxicity. GS4 will quickly become dilute, minimizing the risk of fish kill.
- GS4 will not promote algae growth.

Corrosion Properties

Heat Transfer Fluid is specially formulated with corrosion inhibitors to provide protection for cast iron, carbon steel, aluminum and copper, as well as provide compatibility with a wide variety of plastics and elastomers. Do not use at less than 25% by weight mixtures!!

Handling, Storage, and Disposal

Storage of GS4 heat transfer fluid does not present any unusual problems. The liquid is low in toxicity, is not flammable and remains fluid under all normal conditions. This material may be stored and handled in its original containers or in equipment made of polyethylene, stainless steel, mild steel, lacquer lined steel or glass.

This material is 100% water soluble. Spills may be cleaned up with water. GS4 is not expected to present any environmental problems. Diluted spent fluids that are not otherwise contaminated may be disposed of in local sewage treatment facilities unless state or local regulations prohibit such disposal. In the event of disposal of a large amount, treatment facilities should be advised and prepared for such disposal in advance.

Adjustments of Fluid Composition

The degree of freezing point protection depends on the concentration of GS4 in water. Distilled or deionized water should be used for dilution to the desired concentration. The concentration may be determined by specific gravity. As long as the fluid remains clear and uncontaminated, additional GS4 may be added as required to adjust the concentration to the desired freezing point. The following chart may be used to determine the freezing point of a well mixed fluid. Drain enough fluid from the system to provide space for adding fresh GS4 to the system. Mix well and recheck the density of the fluid in the system to assure a correct composition.

Equipment: Specific Gravity Hydrometer, 0.002 subdivisions. Thermometer not required.

TECHNICAL SUPPORT
Vanguard Plastics, Inc.
831 W. Vanguard St.
McPherson, KS 67460
Phone: 800-775-5039 or
316-214-6369

FIGURE 32
FREEZING POINT CURVE--BY VOLUME

FREEZING POINT (Degrees F)

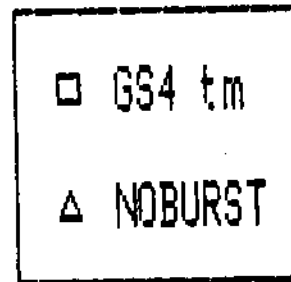
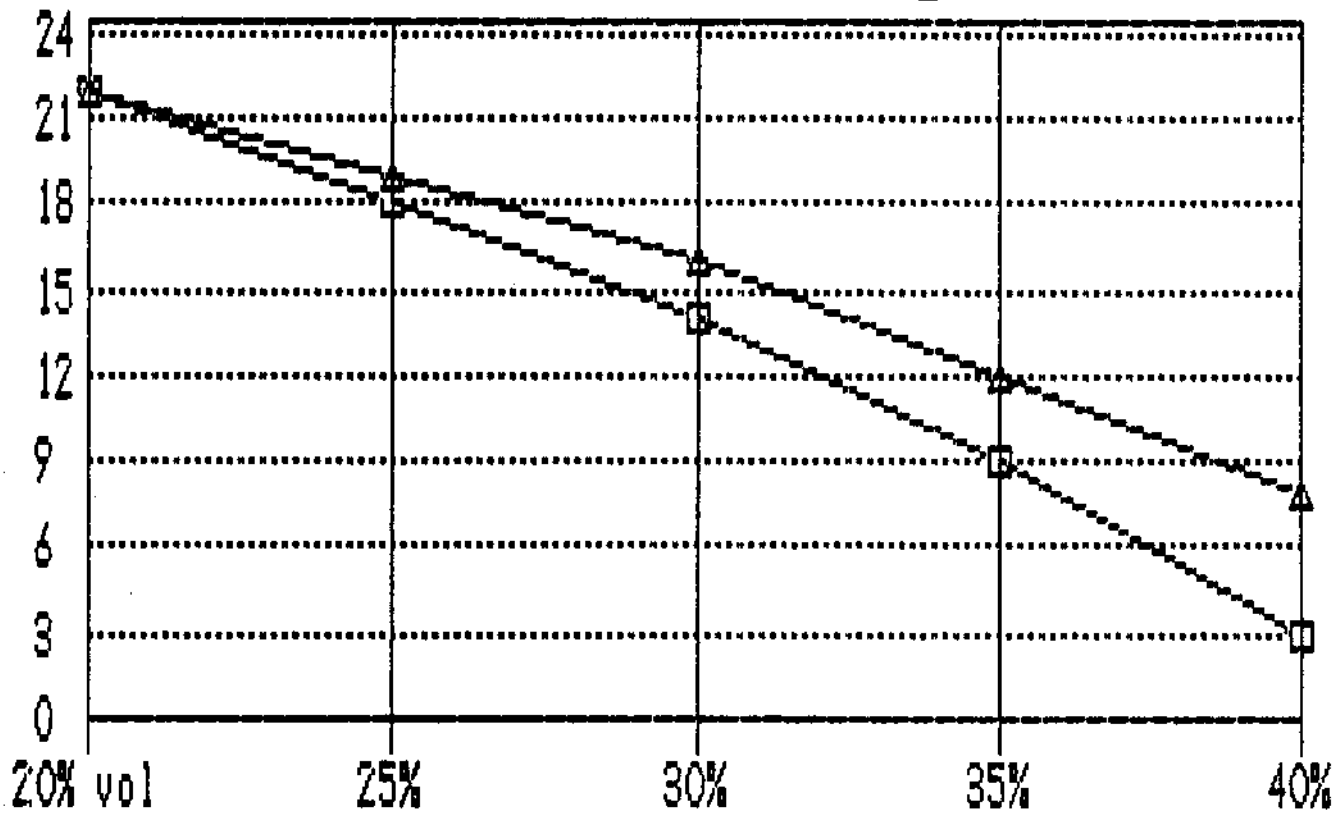

VIII. SYSTEM START UP

Once the ground water source heat pump system is completely installed, the final step is to start the system and check for proper operation. The proper sequence on startup is to begin with the water side of the system, then proceed to the air side.

FLUSH THE SYSTEM PIPING--DO NOT connect the water lines from the earth coupled loop to the unit before the water lines have been flushed. Flushing will remove any debris and air that may be trapped in the piping. If water is circulated through the unit without first flushing the water loop piping, the heat pump unit may be damaged. Therefore, follow this procedure carefully before connecting to the unit.

When an earth coupled system, connect the piping to flushing rig (Figure 33) that can be easily constructed from a 55 gallon drum, 1 hp water pump, and some relatively inexpensive piping. Fill the earth coupling as much as possible then hook one side of the earth coupling to the pump and return the other side of the earth coupling to the top of the barrel. Fill the barrel and turn on the pump. The barrel must be kept at least half full of water to avoid sucking air into the system.

When the proper flushing connections have been made, check to be sure all accessible fittings are secure and tight and any valves in the line are open. Start the pump and let the water circulate for at least 20 - 30 minutes. This will allow enough time for any entrained air or debris to be purged from the system. With an earth coupled system, check for possible leaks in the loop by establishing 50 PSIG water pressure in the line and checking the gage after 15 minutes. If there are no leaks in the line, the pressure will not drop. If the pressure in the line falls by more than 5 PSIG, it may be necessary to dig holes at the coupling locations to check for loose or failed couplings. With all ground water systems, check carefully for any visible signs of water leakage before digging or boring down to any coupling locations. If visible leakage is found, correct the problem and retest the system. If no visible signs of leakage exist and the piping system is losing more than 5 PSIG in 15 minutes, then proceed to locate the source of the leakage. Remember, for proper system operation, there can be no leakage in the water loop.

FLOW RATE (GPM) REQUIRED FOR DEBRIS
FLUSHING AND AIR PURGING TO GIVE AN
TABLE 7 AVERAGE VELOCITY OF 2 FPS IN PIPE

Nominal Pipe Size (Inches)	Pipe ID (Inches)	Flow Rate (GPM)
Polyethylene, SCH40		
1 3/4	0.860	4.3
2 1	1.077	5.7
3 1-1/4	1.358	9.0
4 1-1/2	1.554	11.8
5 2	1.943	18.4
Polyethylene, SDR-11		
6 3/4	0.824	3.3
7 1	1.049	5.4
8 1-1/4	1.380	9.3
9 1-1/2	1.610	12.7
10 2	2.067	20.9
Polybutylene, SDR-17, IPS		
11 1-1/2	1.676	13.8
12 2	2.095	21.5
Polybutylene, SDR-13.5, CTS		
13 1	0.957	4.5
14 1-1/4	1.171	6.7
15 1-1/2	1.385	9.4
16 2	1.811	16.1

BOILER DRAINS--Boiler drains are located on both sides of the circulator for final filling, air purging and antifreeze addition.

The top drain should be the highest point in the equipment room piping. This will help purge air out of the system during final filling at start up.

FLOW RATE ADJUSTMENT--When the earth loop has been completely flushed and leak tested, remove the flexible connection from the pipe ends and hook up the supply and return lines to the appropriate connections on the water source heat pump, turn on the circulator pump, and let the water circulate through the system for 5 minutes. DO NOT allow the heat pump to operate yet. The proper sequence is to allow water to circulate, adjust the flow rate, then operate the heat pump.

FIGURE 33
PORTABLE RIG FOR FLUSHING EARTH COUPLED SYSTEMS
EARTH COIL START-UP

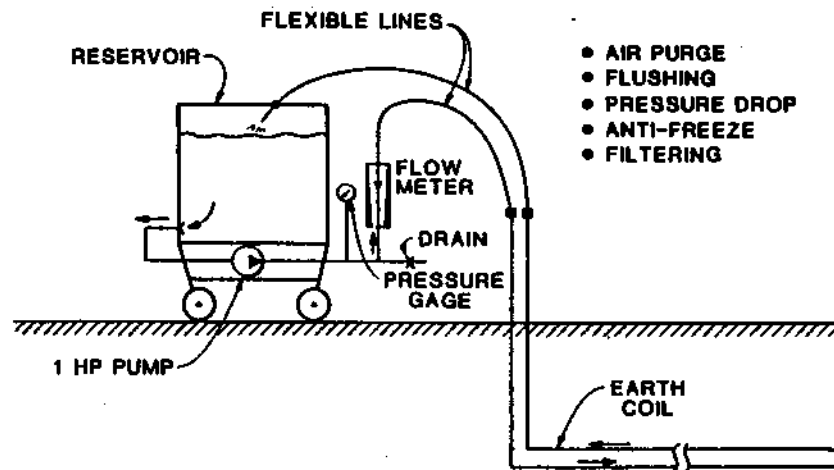

If the circulator does not operate immediately, turn off the electrical power to the heat pump, close the isolation flanges, remove the indicator plug, insert a small blade screwdriver into the motor shaft, and turn gently until the shaft moves freely. Replace the indicator plug, open the isolation flanges, wait a few minutes, then restart the pump.

The flow rate should be the desired operating flow of the model of water source heat pump being used (see manufacturer's specifications). Water flow should not be less than that of the minimum flow rate required for the model of water source being used. If water flow is less than system calculations indicate, check your calculations. If the calculations are correct, there is some trapped air or restriction in the water circuit.

ADDING ANTIFREEZE

Two short pieces of hose, a bucket and a small submersible pump or flush cart are needed to add the antifreeze.

Block the system by closing a ball valve. Blocking flow prevents the antifreeze from being pumped into one boiler drain and out the other.

Attach hoses to the boiler drains. Run the uppermost hose to drain. Connect the other hose to the submersible pump in the bucket. Put full strength antifreeze into the bucket and pump in the amount needed to give the required percentage by volume. When the required amount has been pumped in, pressurize the system to 30 psig then turn off the pump, close the boiler drains, and disconnect the hoses and open the isolation flange or gate valve.

PROPER PLANNING YIELDS PROBLEM-FREE GROUND-SOURCE HEAT PUMP SYSTEM

This article was first published in *THE SOURCE*, a newsletter from the Oklahoma State University International Ground Source Heat Pump Association.

When the topic of ground-source system troubleshooting is broached, certain problems seem more common than others. One situation is a system which has not been thoroughly purged of air. Another typical scenario is a vertical system with too many bore holes.

Failure to purge a system of air can lead to various problems. Air in a system can corrode the metallic components in the circulating system, causing their eventual failure. Under certain circumstances, excessive air in the system may block water flow in some branches of a parallel ground heat exchanger.

For example, air trapped at the top of one of several vertical ground heat exchanger loops may cause an air column that will prevent flow through the loop. This, in turn, results in inadequate heat transfer in the ground heat exchanger system.

If a fluid velocity of 2 ft/sec is maintained for 20 to 30 minutes, the air will be removed in all cases (See Table 7). Header designs have been created for easy air purging and debris removal.

Check Bore Holes

Too many bore holes can also cause complications because the water or antifreeze solution is not flowing properly through the loops, resulting in insufficient turbulence for heat transfer. One symptom of this particular problem is cold-loop water in the winter, which results in reduced heating capacity. There may be no evidence, however, of this problem during summer, when the water in the ground heat exchanger is warm.

The formula for calculating the maximum number of bore holes is the heat pump manufacturer's recommended flow rate divided by the minimum required flow in the pipe for turbulence.

$$\frac{\text{Manufacturer's recommended flow rate}}{\text{Minimum flow in pipe for turbulence}} = \text{Maximum number of bore holes}$$

For example, assume the heat pump manufacturer's recommended flow rate was 18 gpm and the minimum flow for the selected pipe and fluid for turbulence was 3.5 gpm, then:

$$\frac{18 \text{ GPM}}{3.5 \text{ BPM/loop}} = 5.14$$

When the division yields an uneven number, always round down. Rounding down 5.14 gives 5, the maximum number of bore holes the system can have and maintain adequate fluid turbulence for good heat transfer. By properly calculating the maximum number of bore holes in this way, future system problems can be alleviated.

Too much antifreeze can also cause poor heat transfer in the ground heat exchanger. The minimum flow rate is different for each type of fluid. Determine if the minimum flow rate exists in all fluid paths for the specific fluid chosen (See Table 3). If not, select a new piping arrangement that gives higher flow in all paths.

When such problems occur, make sure all air is purged from the system. Also check the antifreeze levels. Finally, an additional circulating pump may be necessary to ensure the minimum flow rate exists in all loops. (4)

(4) Air Conditioning, Heating & Refrigeration News. October 1, 1990.

RULE OF THUMB

When using 20% propylene glycol antifreeze solution, the minimum water flow rate for the selected heat pump will need to be increased 40% to have the same heat transfer.

Example: A 4 GPM flow would need to be increased to 5.6 GPM for approximately the same heat transfer properties.

RULE OF THUMB

To adjust the total earth loop piping head loss for other antifreezes and water solutions at 25 deg. F, multiply pressure loss on line 6 for water by:

Fluid	Multiplier
23% Propylene Glycol	1.38
30% Noburst	1.33
20% Methanol Alcohol	1.25
27% Potassium Acetate (GS4)	1.17

Assumed fluid properties for Table 3 at 25°F flow temperature*.

<u>Solution</u>	<u>% Volume</u>	<u>Viscosity (Centipoise)</u>	<u>Density (Lb./Ft.3)</u>
Water	100	1.55	62.4
Propylene Glycol	23	5.2	63.9
Noburst	30	4.7	64.2
GS4	27	3.1	68.3

*Water at 40°F

IX. OTHER ITEMS TO BE FOLLOWED

- A. Follow the Installation Instructions for the water source heat pump model being used to check the operation of the refrigeration cycle and specifics in installation in structure. The equipment manual will also show the electrical hookup and air flow requirements.
- B. Follow the Air Conditioning Contractors of America "Manual D" for proper duct design for the air side of the system.

X. CLOSED LOOP SYSTEMS SUSPENDED IN PONDS AND LAKES

The pond or lake should be a minimum of 1/2 acre in size with a volume of water equal to twice the size of the house being heated minimum depth of 7 feet for plastic lake exchanger. A larger pond will be required in colder climates. The zone where the exchanger is placed should remain above 38° in winter.

CAUTION: The performance of this type of system sometimes is hard to predict due to water stratification and other factors. Be very cautious about using this type of system. Again, make sure the ground water heat pump is designed to operate at lower water temperatures.

LAKE EXCHANGER CONSTRUCTION--PLASTIC

Use 3/4 inch or larger polyethylene or polybutylene piping approved for earth loop installation. 350 feet of tubing length will be required for each ton of heat pump capacity. The piping may be laid out for series flow (or parallel) as shown (See Figure 35).

With an increasing number of pond loops being installed, it has been reported that there are several pond loops going in with 500 - 600 ft. coils. It is recommended that pond loops (either Polybutylene or Polyethylene) use 300 - 350 ft. coils due to the heat transfer in a pond application. The larger coils simply do not have as much surface area exposed (i.e. the extra 200 - 300 ft. of pipe in the center of the coil), thus heat transfer by natural convection is impaired. For instance, Figure 35 shows a typical 3 ton pond loop--3 coils of 350 ft.

CALCULATING HEAD LOSS

To determine head losses for sizing pipe, circulation pump, and antifreeze quantities, follow procedures under section entitled, "The circulation System Design".

PLACEMENT

The plastic lake exchanger will float. The lake exchanger will need to be weighted so it will sink to the bottom of the lake or pond. The loop is not designed to settle into the soil in the bottom of the pond.

SERVICE LINES

Bury the service lines a minimum of 4 feet deep or below the frost line, whichever is deeper, across the shore and keep them separated about 2 feet in the trench.

Follow the "Horizontal Earth Coil Installation" instructions for the service lines to the lake exchanger.

ANTIFREEZE

The equivalent of 27% GS4 is required.

**FIGURE 34
VERTICAL SYSTEM
POND LOOP SYSTEM**

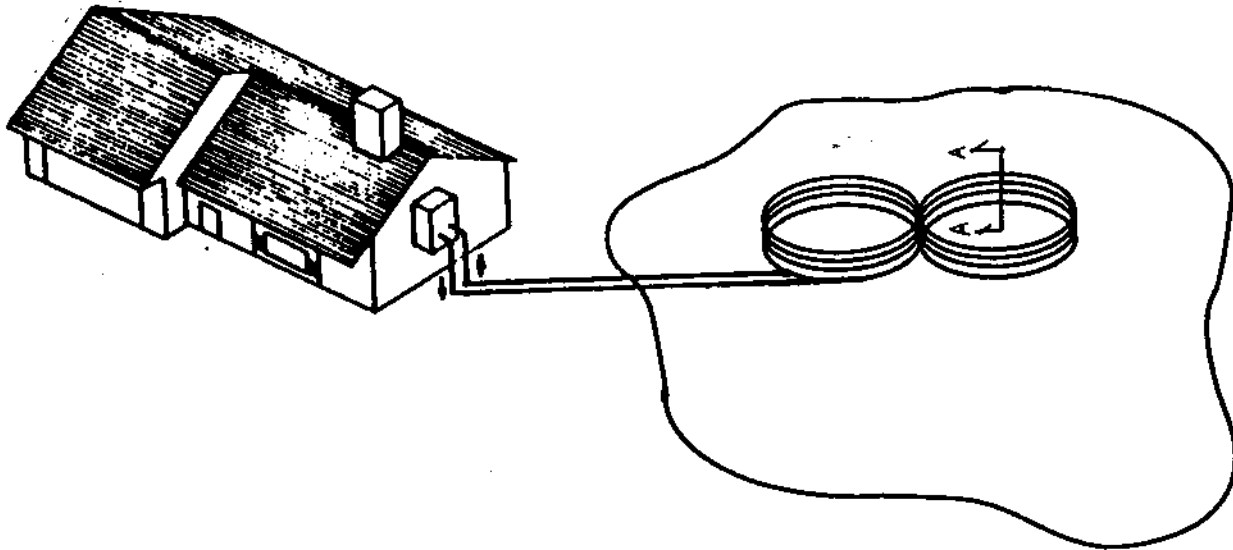

**FIGURE 35
PLASTIC CLOSED LOOP LAKE EXCHANGER**

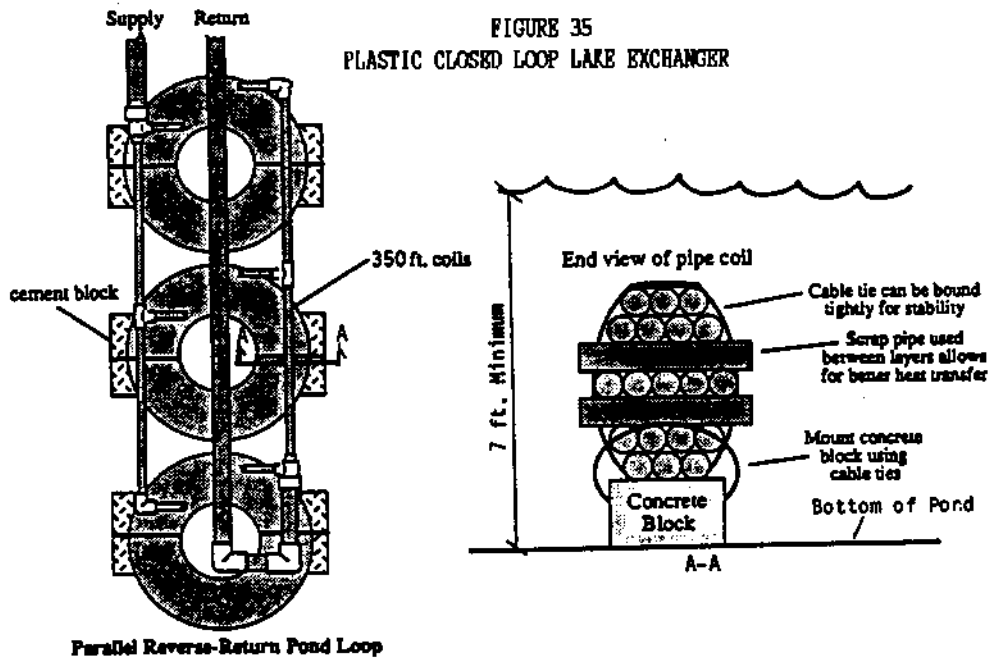
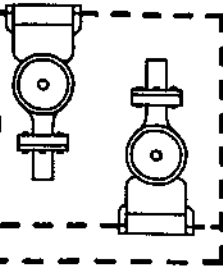

Figure A-A shows a new idea for increasing flow through the coils simply using pieces of pipe between the layers. This drawing is a cut-away view, looking at a dissected coil. Note that the cable tie can now be tightened to make the coils more manageable, while the scrap pipe still allows flow through the coil.

ACKNOWLEDGMENTS

1. Albertson, P. 1983, Pamphlet "Earth-Coupled Water Source Heat Pump", Ditch Witch, Perry, OK.
2. Bose, James E. et al. 1984, "Closed-Loop Ground-Coupled Heat Pump Design Manual", Oklahoma State University, Stillwater, OK
3. Bose, James E., "Soil and Rock Classification For The Design of Ground-Coupled Heat Pump Systems" International Ground Source Heat Pump Association, Stillwater, OK.
4. Braud, H.J. Klinkowski, H. and Oliver J. 1983, "Earth-Source Heat Exchanger for Heat Pumps", Louisiana State University, Baton Rouge, LA.
5. Braud, H.J., Baker, F.E. and Smilie, J.L. 1984, "Earth-Coupled Heat Pump Systems", Louisiana Cooperative Extension Service, Baton Rouge, LA.
6. Vanguard Plastics, Inc., 1994 "GS4 Fluid Properties", 831 N. Vanguard St., McPherson, KS 67460
7. Eckhart, Frank, "Grouting Procedures for Ground-Source Heat Pump Systems", Ground Source Heat Publications, Oklahoma University, Stillwater, OK.
8. Eitelman, L. 1983, Letter "Pipe Pressure Loss Tables for Polyethylene Pipe", McElroy Manufacturing, Inc., Tulsa, OK.
9. Hatherton, D.L. 1983 "Trenched and Drilled Earth-Coupled Heat Pump Systems", Ground Water Energy Newsletter, (Sept; Oct. 1983), Worthington, Ohio.
10. Hawkinson, G. 1984, Letter "Pipe Head Loss Tables for Polybutylene Pipe", Vanguard Plastics, Inc. McPherson, KA.
11. Partin, James R. 1981, "Drilled and Trenched Earth-Coupled Heat Pump Exchangers", Stillwater, OK.
12. Bose, J.E., 1985, "Design/Data Manual For Closed Loop Ground-Coupled Heat Pump Systems", American Society of Heating, Refrigerating and Air Condition Engineerings, Inc., Atlanta, GA.
13. NRECA, 1987, Closed Loop/Ground Coupled Heat Pump Systems Installation Guide, National Rural Electric Cooperative Association, Washington, D.C. 20036
14. The Noble Company, P. O. Box 332, 614 Monroe Street, Grand Haven, MI 49417

WATER
CIRCULATING
PUMPS



REFER TO CONTROL CIRCUIT WIRING ON CONTROL PANEL COVER AND INSTALLATION INSTRUCTIONS FOR HOOK-UP OF OPTIONAL DUCT HEATER

SET HEAT ANTICIPATOR AT .45A FOR EITHER TYPE OF WALL THERMOSTAT

CHECK LIGHT



T87F311/4253U1089



T874A1129/4674L1181



24V TERM. BLOCK

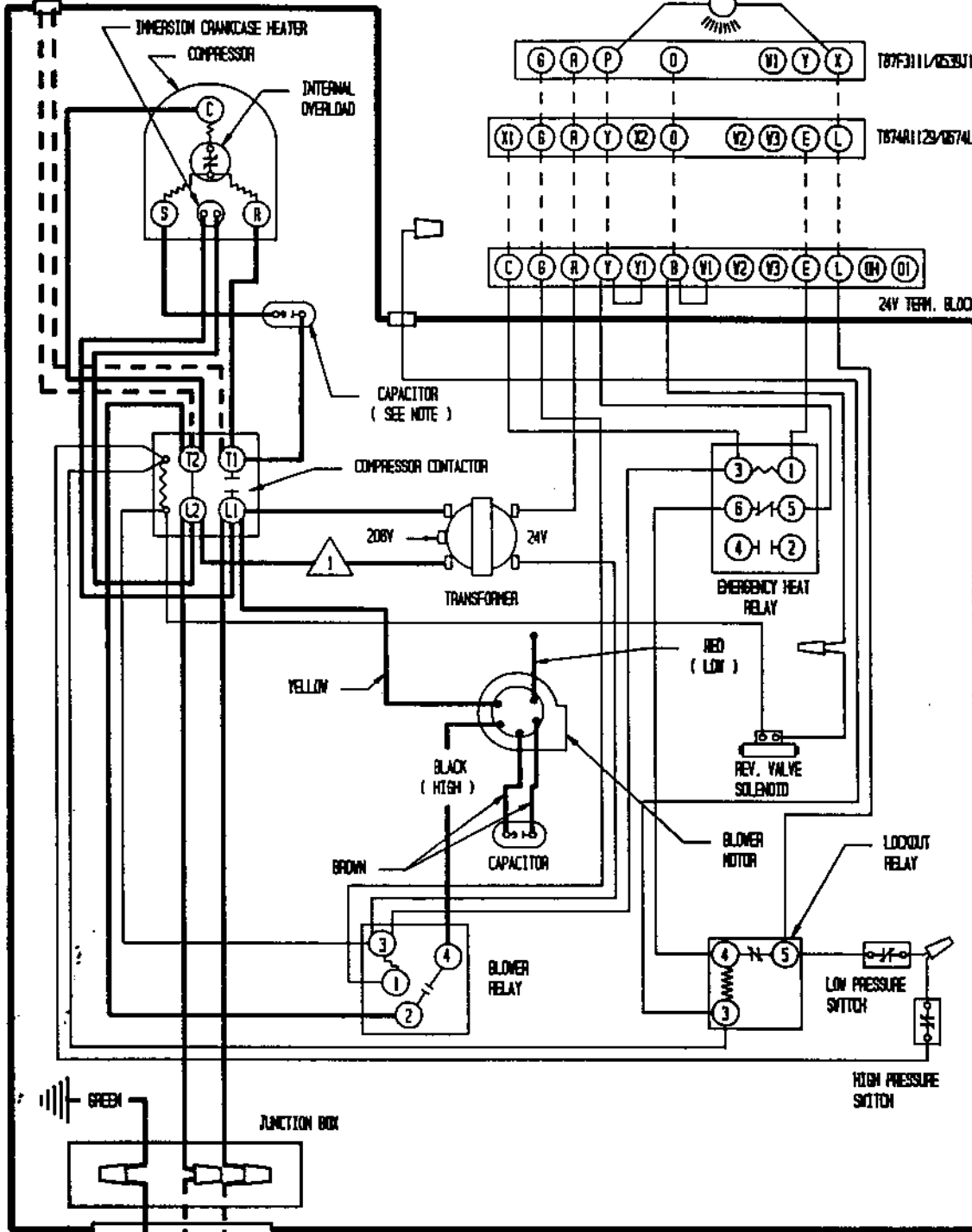

Z3D/208-50-1

⚠ FOR 208V OPERATION MOVE THIS WIRE TO 208V TRANSFORMER TAP

⚠ USE WIRING RATED FOR USE IN NEC CLASS I SYSTEM

CAPACITOR RATINGS		
MODEL	COMPRESSOR	BLOWER
WPV308	30/370	7-1/2/370
WPV368	40/370	

	FACTORY WIRING	FIELD WIRING
	Low Voltage	—————
High Voltage	—————	- - - - -

USE COPPER CONDUCTORS ONLY

CIRCULATING PUMP WORKSHEET

1. Find the Bard heat pump model used in Table 2. MODEL _____
2. Enter water coil head loss (Table 2): _____
3. Continue across Table 2 to find GPM flow required for this heat pump. _____ GPM
4. Count each elbow, tee, reducer, air scoop, flowmeter, etc., as 3 feet of pipe equivalent. Add the equivalent feet of pipe to the actual feet of pipe used. The total length is used to determine the piping heat loss below.

Pipe Type and Size	No. Elbows, Tees Devices, Etc *	x 3	Equiv. Ft. Of Pipe	Actual Pipe Used	Total Pipe Length
_____	_____	x 3	_____	_____	_____
_____	_____	x 3	_____	_____	_____
_____	_____	x 3	_____	_____	_____
_____	_____	x 3	_____	_____	_____
_____	_____	x 3	_____	_____	_____

*If the pipe is bent at a 2 foot radius or larger, DO NOT figure the curve as an elbow.

5. PIPING HEAD LOSS for different types of pipe at GPM flow rate of water source heat pump. NOTE: For parallel earth loop system, figure for only one loop.

Pipe Type and Size	Total Pipe Length	Piping** Head Loss (Table 3)	ft. hd.
_____	(_____ - 100)	_____	_____
_____	(_____ - 100)	_____	_____
_____	(_____ - 100)	_____	_____
_____	(_____ - 100)	_____	_____
_____	(_____ - 100)	_____	_____

**For a parallel earth loops, divide the heat pump GPM (line 3) by number of loops to determine flow rate through each individual loop to select piping head loss.

SUBTOTAL ft. hd.

6. Multiply SUBTOTAL by multiplier (see Table 5) to obtain TOTAL HEAD LOSS FOR SYSTEM using antifreeze solution.

TOTAL HEAD LOSS ft. hd.

7. PUMP SELECTION: Use Table 4 and flow rate, (line 3). Select the pump output which is larger or equal to the TOTAL HEAD LOSS FOR SYSTEM (line 5 or 6).

Circulating Pump Model No. Pumps

If the TOTAL HEAD LOSS calculated in line 6 is greater than the pump outputs listed in Table 4, go to the pump manufacturer's performance curves and find the required GPM flow for the heat pump. Pump performances are listed for each pump model at different flow rates.

Series pump performance is simply a TOTAL OF THE INDIVIDUAL PUMP PERFORMANCES. If one pump can overcome 10 feet of heat loss, two can overcome 20 feet of head loss, three can overcome 30 feet of head loss, etc.

TABLE 2 WATER COIL PRESSURE DROP

Model	MQS30A WPV30B	MQS36A WPV36B	Model	MQS42A WPV53B	WPV62B
GPM	Feet Head	Feet Head	GPM	Feet Head	Feet Head
4	4.6	4.4	6	5.8	5.8
5	6.9	4.6	7	7.4	8.1
6	10.0	5.5	8	9.2	10.4
7	13.1	6.9	9	12.0	12.9
8	17.3	9.0	10	15.0	15.5
9	21.9	12.7	11	17.8	18.5
10	27.7	17.5	12	20.8	21.5
11	34.1	24.0	13	24.2	24.7
12	40.6	35.3	14	27.7	28.4
13	46.8	47.5			

TABLE 4 SELECTION OF CIRCULATION PUMP OR PUMPS

Pump Output (Feet of Head) @ GPM @ Top Of Column	Grundfos* Pump Models	No. Pumps	Water Flow Rate Required in G.P.M.						
			4	6	8	10	12	14	16
10	UP26-96F	1	26.5	25	22.5	20	18	16	14
	UP26-96F	2	53	50	45	40	36	32	28
	UP26-99F	1	30.5	29	28	27	25	23.5	22
	UP26-99F	2	61	58	56	54	50	47	44
15	Loop Pump Models								
	GPM-1**			28.5	27	25	23	21	18.5
20	Loop Pump Models								
	GPM-2**			57	54	50	46	42	37

*Other models of circulation pumps may be used. Consult the manufacturer's specifications

**See manual 2100-212 GPM series loop pump modules for complete details

TABLE 3 MINIMUM FLOW IN PIPE FOR TURBULANCE (GPM)*

Nominal Pipe Size (Pipe ID)	Water at 40 deg F	Cryotech GS4 27% Volume 25 deg F	Noburst 30% Volume 25 deg F	Propylene Glycol 23% Vol. 25 deg F
PB (SDR-11)				
3/4" (0.86)	1.1	1.9	3.1	3.5
1" (1.077)	1.3	2.4	3.9	4.5
1-1/4" (1.385)	1.7	3.0	5.0	5.6
1-1/2" (1.554)	1.9	3.5	5.7	6.4
2" (1.943)	2.4	4.3	7.0	8.0
PB (SCH 40)				
3/4" (0.824)	1.0	1.9	3.0	3.4
1" (1.049)	1.3	2.4	3.8	4.3
1-1/4" (1.380)	1.7	3.1	5.0	5.7
1-1/2" (1.610)	2.0	3.6	5.8	6.6
2" (2.067)	2.5	4.6	7.6	8.5
PB(SDR-17,IPS)				
1-1/2" (1.676)	2.1	3.7	6.0	6.9
2" (2.095)	2.6	4.6	7.6	8.6
PB(SDR-13.5,CTS)				
1" (0.957)	1.2	2.1	3.5	4.0
1-1/4" (1.171)	1.4	2.6	4.3	4.8
1-1/2" (1.385)	1.7	3.1	5.0	5.7
2" (1.811)	2.2	4.0	6.6	7.4

*For each separate loop.

NOTE: When selecting pipe size for parallel flow, it is necessary to maintain turbulent flow in the earth coil for heat transfer. The table above lists the minimum flows for turbulence.

TABLE 5 PIPING FEET OF HEAD LOSS AT DIFFERENT FLOW RATES PER 100 FEET

Pipe Size and Material	DI	G.P.M. FLOW RATE									
		1	2	3	4	5	6	8	10	12	14
Connection Hose 1"	1.050	*	*	*	1.33	1.95	2.68	4.43	6.53	8.99	11.77
PVC 3/4" - 200 PSI		*	*	*	3.7	5.7	*	*	*	*	*
PVC 1" - 200 PSI		*	*	*	1.0	1.9	2.7	4.2	6.3	8.9	11.8
Copper 3/4"		*	*	*	4.3	6.3	*	*	*	*	*
Copper 1"		*	*	*	1.5	1.9	2.7	4.5	6.9	9.6	12.8
PE3408 (Polyethylene)		DI									
1. SDR-11 3/4	0.860	0.31	1.03	2.07	3.41	5.03	*	*	*	*	*
2. SDR-11 1	1.077	0.11	0.36	0.71	1.18	1.73	2.38	3.92	*	*	*
3. SDR-11 1-1/4	1.358	*	0.12	0.24	0.39	0.58	0.79	1.31	1.93	2.65	3.47
4. SDR-11 1-1/2	1.554	*	*	0.13	0.21	0.31	0.42	0.69	1.02	1.40	1.83
5. SDR-11 2	1.943	*	*	*	0.07	0.11	0.15	0.24	0.35	0.48	0.63
6. SCH 40 3/4	0.824	0.38	1.26	2.54	4.18	6.16	8.46	*	*	*	*
7. SCH 40 1	1.049	0.12	0.40	0.81	1.33	1.96	2.69	4.45	*	*	*
8. SCH 40 1-1/4	1.380	*	0.11	0.22	0.36	0.54	0.74	1.21	1.79	2.46	3.21
9. SCH 40 1-1/2	1.610	*	*	0.11	0.18	0.26	0.35	0.58	0.86	1.18	1.55
10. SCH 40 2	2.067	*	*	*	*	0.08	0.11	0.18	0.26	0.36	0.47
PE2110 (Polybutylene)		DI									
11. SDR-17, IPS 1-1/2	1.676	*	*	0.09	0.15	0.21	0.29	0.48	0.71	0.98	1.28
12. SDR-17, IPS 2	2.095	*	*	*	0.05	0.07	0.10	0.17	0.25	0.34	0.44
13. SDR-13.5, Cts 1	0.957	0.19	0.62	1.25	2.06	3.03	4.16	*	*	*	*
14. SDR-13.5, Cts 1-1/4	1.171	*	0.24	0.48	0.79	1.17	1.60	2.64	*	*	*
15. SDR-13.5, Cts 1-1/2	1.385	*	0.11	0.22	0.36	0.53	0.72	1.19	1.76	2.41	3.2
16. SDR-13.5, Cts 2	1.811	*	*	0.06	0.10	0.15	0.20	0.33	0.49	0.68	0.88

NOTES: 1. These head losses are for water at 40 degrees F temperature.
 2. Count each elbow, tee, reducer, air scoop, flow meter, etc., as 3 feet of equivalent pipe length and add to actual measured pipe length for total length.
 3. To adjust the total earth loop piping head loss for other antifreezes and water solutions at 25 degrees F, multiply pressure loss on line 6 for water by:
 Propylene Glycol - 1.38, Noburst - 1.33, Cryotech GS4 - 1.17

EARTH COUPLED LOOP DESIGN

1) Return Design To: _____ Date: _____
 Street: _____ Attn: _____
 City and State: _____ Zip: _____
 Telephone No.: _____ Fax No.: _____

Dealer/Job Name: _____ Location: _____
City _____ State _____

2) Building or *Zone Design Load: COOLING _____ btu/h HEATING _____ btu/h
 *NOTE: Buildings too large for one heat pump, complete worksheet for each zone.

3) Size Heat Pump to satisfy: { } Cooling Load { } Heating Load**
 **NOTE: Recommend sizing for the greater of 60 to 90% of heating load or cooling load

4) Geographic Location of Job (NEAREST): _____
 SEE TABLE 10 ON BACK OF SHEET City _____ State _____

5) Local Ground Well Water Temperature: _____ °F

6) Provide COST OF OPERATION ESTIMATES: { } No { } Yes Local cost per KW \$ _____

7) Type of Bard Heat Pump to be used: { } Packaged { } Split w/{ } Blower Coil
 Model _____ w/{ } A-Coil

8) Type of Pipe to be Used: # _____ Nominal Size: _____ SEE TABLE 9 ON
 If system requires larger or smaller pipe, 2nd choice: # _____ BACK OF SHEET

9) () HORIZONTAL SYSTEM (Trenches):

Type of Soil at Trench Depth	Thermal Cond. (BTU/ft-hr-F)	Thermal Diff. (ft ² /day)
{ } Sand or Gravel {Light soil damp}	.44	.42
{ } Loam {Heavy soil dry}	.52	.46
{ } Clay {Heavy soil damp}	.64	.50
{ } Silt, Sat. Clay or Silt {Heavy soil damp}	.96	.61
{ } Saturated Sand {Heavy soil saturated}	1.44	.86

Horizontal Pipe Configuration in Trench: SEE BACK OF SHEET

{ } One pipe	{ } 2 pipes: stacked	{ } 2 pipes: side/by/side
{ } Other	{ } 4 pipes: stacked	{ } 4 pipes: stacked pairs
	{ } 3 pipes: side/by/side	{ } 6 pipes: stacked in 2 layers

() VERTICAL SYSTEM (Bore Holes):

Type of Soil	Thermal Cond. (BTU/ft-hr-F)	Thermal Diff. (ft ² /day)
{ } Saturated Silt or Clay {Damp heavy soil}	.96	.61
{ } Avg Rock, Sat Sand or Clay {Heavy soil sat or avg rock}	1.44	.86

Vertical System Configuration With Bore Holes:
 { } One U-bend (2 pipes) { } 2 U-bends (4 pipes)

10) Fluid Flow { } SERIES: typically 1-1/4" to 2" pipe used
 Thru Loop System: { } PARALLEL: typically 3/4" to 1" pipe used
 Total header length _____ ft. _____ dia. in.

11) Anti-Freeze Solution: { } GS4™ (Potassium Acetate) { } NONE
 { } NOBLE NOBURST (Propylene Glycol) { } PROPELENE GLYCOL



Heating & Cooling Products

Send or FAX to: Earth Coupled Loop System Design
 Bard Manufacturing Company
 P. O. Box 607
 Bryan, Ohio 43506
 FAX# 419-636-2640

If you have any questions, see manual 2100-099.

(INFO ON BACK)

F1115-194

IGSHPA GS-System Videotapes

GS-Systems: An Introduction

This is an excellent marketing video targeted at the general consumer. **GS-Systems: An Introduction** contains an informative narrative, colorful graphics and convincing testimonials from satisfied homeowners. This video supplies a broad education of the basics behind the ground source system technology. It also ties in perfectly with **GS-Systems - An Introduction** brochure. This video is certainly a must for explaining the many GS-System benefits to potential customers.

Cat. # 03016

Price \$50.00

Inside GS-Systems

GS-Systems are simple. And this insightful video proves just how simple GS-System operation is. **Inside GS-Systems** reveals the inner workings of a ground source system piece by piece. This program also explains the remarkably simple principle on which these systems work. Such a video is ideal for installers, contractors, dealers or anyone involved with GS-System installation or marketing. **Inside GS-Systems** would also be appropriate for the homeowner wanting more than a general knowledge of these efficient systems.

Cat. # 03017

Price \$50.00

Soil Identification for GS-System Installation

Soil identification is a very important step of any GS-System installation. Soil type can affect thermal conductivity and pipe length of a ground heat exchanger. This video points out many tips and details several simple tests for soil identification. This program compliments the field manual, **Soil and Rock Classification for the Design of Ground-Coupled Heat Pump Systems**. These two teaching aids combined provide all of the information necessary to determine soil type at a GS-System installation site.

Cat. # 03019

Price \$50.00

Rock Identification for GS-System Installation

Rock identification, like soil identification is a crucial aspect of GS-System installation. Rock type can influence the length of pipe needed for a ground heat exchanger which functions at peak efficiency. This video will introduce you to the various thermal conductivity values associated with each of the eight petrologic groups. The rock identification video will also detail several tests and list characteristics assigned to each petrologic group. These tests and characteristics will help you identify rocks at any GS-System installation site. This video is to be used as a teaching aid with the field manual, **Soil and Rock Classification for the Design of Ground-Coupled Heat Pump Systems**.

Cat. # 03020

Price \$50.00

GS-Systems: Flushing, Purging and Pressurizing

Before operating a GS-System, certain procedural and verification checks must be made to ensure the system will perform properly and as designed. Debris must be flushed from the ground heat exchanger and air must be purged from the system, as well. **GS-Systems: Flushing, Purging and Pressurizing** is a procedural video which explains each step of this important phase of GS-System installation. This video, in conjunction with the ground source system installation guide, is a complete flushing and purging reference for contractors and installers.

Cat. # 03015

Price \$50.00

Examples of GS-Systems

This unique video is perfect for the general consumer or those involved in GS-System design and installation. **Examples of GS-Systems** describes the versatility of these systems and the various installation options. This video discusses the differences between an open-loop system and a closed-loop system. In addition, this program describes horizontal and vertical systems. Finally, this video presentation demonstrates the flexibility of a GS-System unit. A system can be a split system, a dual-fuel system or a package unit. Ductwork can be designed specifically for each individual home. **Examples of GS-Systems** describes all of these options and more.

Cat. # 03018

Price \$50.00

GS-Systems: Installation Overview

As the title suggests, this informative video is a complete overview of the simple GS-System installation process. **GS-System Installation Overview** answers the most frequently asked questions by homeowners interested in ground source systems. In layman's terms, this video explains GS-System design and layout, the workings and installation of a ground heat exchanger, trenching and drilling processes and much more.

Cat. # 03021

Price \$50.00

Proper Drilling and Trenching Procedures for GS-System Installations (Parts 1 and 2)

This in-depth video details both trenching techniques and drilling procedures for ground heat exchanger installation. This video sets forth standard installation practices which result in the most efficient GS-System possible. This program follows the ground source system installation guide. Contractors and installers will find that after watching this practical video, they have learned many useful procedures for completing a trouble-free ground source system.

Cat. # 03022

Price \$50.00

Ground Source Heat Pump Publications
Oklahoma State University
101 Industrial Building
Stillwater, Oklahoma 74078

ORDER FORM BM10821-191



MAIL TO:

GROUND SOURCE HEAT PUMP PUBLICATIONS
Oklahoma State University
101 Industrial Building
Stillwater, Oklahoma 74078



IGSHPA GS-SYSTEM VIDEOTAPES

CAT. #	QTY	TITLE	EACH
03015		GS-Systems: Flushing, Purging and Pressurizing	\$50.00
03016		GS-Systems: An Introduction	\$50.00
03017		Inside GS-Systems	\$50.00
03018		Examples of GS-Systems	\$50.00
03019		Soil Identification for GS-System Installation	\$50.00
03020		Rock Identification For GS-System Installation	\$50.00
03021		GS-Systems: Installation Overview	\$50.00
03022		Proper Drilling and Trenching Procedures For GS-System Installations	\$50.00
Total GS-System Video Tapes			
50% Discount If Complete Set Of Tapes Is Ordered			
Reference Number BM10821-191			
Applicable Taxes*			
TOTAL			

Oklahoma residents add local state sales tax. Shipping will be U.P.S. Ground continental U.S.

PAYMENT: Check enclosed for \$ _____ Purchase Order enclosed _____
 _____ Mastercard _____ Visa Account Number _____
 Exp. Date _____ Signature _____

Purchase order must be company recognized and signed by company officer or purchasing agent.

**For ordering information or to place an order:
Call toll free 1-800-626-4747 or FAX to 1-405-744-6187.**

SHIP TO:

Name: _____
 Street: _____
 City: _____ State: _____ Zip: _____
 Attn: _____

BILL TO:

Name: _____
 Street: _____
 City: _____ State: _____ Zip: _____
 Attn: _____

Special Handling Instructions: _____

