

MANUAL 2100-103 A

INSTALLATION INSTRUCTIONS

LO-BOY

HIGH ECONOMY GAS FURNACE

APPLICATION

This is a forced air gas furnace for installation in building constructed on site. The furnace installation must conform with local building codes and ordinances or, in their absence with the National Fuel Gas Code, ANSI Z223.1-1980, and the National Electrical Code, ANSI/NFPA 70-1981. It is the personal responsibility and obligation of the purchaser to contract a qualified installer to assure that installation is adequate and is in conformance with governing codes and ordinances.

HIGH ALTITUDE APPLICATIONS

Ratings of gas utilization equipment are based on sea level operation and need not be changed for operation at elevations up to 2,000 feet. For operation at elevations above 2,000 feet and, in the absence of specific recommendations from the local authority having jurisdiction, equipment ratings shall be reduced at the rate of 4 percent for each 1,000 feet above sea level before selecting appropriately sized equipment. (Ref. ANSI Z223.1-1980, Par. 8.12).

TRANSPORTATION DAMAGE

All units are packed securely in shipping container. All units should be carefully inspected upon arrival for damage. In the event of damage, the consignee should:

1. Note on delivery receipt of any damage to container.
2. Notify carrier promptly and request an inspection.
3. In case of concealed damage, the carrier must be notified as soon as possible within 15 days after delivery.
4. Claims for any damage, apparent or concealed, should be filed with the carrier, using the following supporting documents, and within the 9-month statute of limitations.
 - a) Original Bill of Lading, certified copy, or Indemnity bond.
 - b) Original paid freight bill of indemnity in lieu thereof.
 - c) Original invoice or certified copy thereof showing trade and other discounts or deductions.
 - d) Copy of the inspection report issued by carrier's representative at the time damage is reported to carrier.

The carrier is responsible for making prompt inspection of damage and for a thorough investigation of each claim.

LOCATING THE FURNACE

When selecting a location for the furnace, observe the following points:

1. The furnace should be set on a level floor. The IL-series Lo-Boy furnaces are shipped raised one inch above the floor to accommodate a damp or wet floor. If greater amounts of water are present at times, the furnace may be elevated further using a concrete base, bricks, patio blocks, etc., making sure adequate support is available for the furnace. Furnaces approved for installation on combustible flooring shall not be installed directly on carpeting, tile or other combustible material other than wood flooring.

2. The furnace should be as centralized as practical with respect to the air distribution system.
3. Provisions must be made for venting combustion products outdoors through an individual venting system.
4. Provide at least the minimum clearances specified in Figure 1 for fire protection, proper operation and service access. These clearances must be permanently maintained. The combustion and ventilating air openings in the front of the furnace must never be obstructed.
5. Minimum service clearances must take precedence over fire protection clearances (minimum installation clearances).
6. All models are approved for a utility room or closet installation.
7. A gas-fired furnace installed in a residential garage must be installed so that the burners and ignition source are located not less than 18 inches above the floor, and the furnace must be located or protected to avoid physical damage by vehicles.
8. For installation in a manufactured building the furnace should be anchored to the floor and attached to any adjacent structural members by screwing support brackets to the back or sides of the furnace with 1/2" sheet metal screws.

DUCT WORK

The air distribution system should be designed and installed in conformance with Manuals 7 or 7A published by Air Conditioning Contractors of America (ACCA), as set forth in their Manual K.

CAUTION

When a furnace is installed so that supply ducts carry air circulated by the furnace to areas outside the space containing the furnace, the return air must also be handled by a duct(s) sealed to the furnace casing and terminating outside the space containing the furnace. This is to prevent drawing possible hazardous combustion products to the circulated air.

When the furnace is used in connection with a cooling unit*, the furnace shall be installed parallel with or on the upstream side of the cooling unit to avoid condensation in the heating element. With a parallel flow arrangement, the dampers or other means used to control flow of air shall be adequate to prevent chilled air from entering the furnace and, if manually operated, must be equipped with means to prevent operation of either unit, unless the damper is in the full heat or cool position.

*A cooling unit is an air conditioning coil, heat pump coil or chilled water coil.

FIGURE 1. MINIMUM CLEARANCES (INCHES)

Model	MINIMUM INSTALLATION CLEARANCES							MINIMUM SERVICE CLEARANCE		
	Top	Front	Vent	Back	Left Side	Right Side	Floor	Front	Sides	Back
IL85D42A IL85D42C	1	6	6*	0	0	1 ⁺	C	24	18 ①	24
IL115D48A IL115D48C	1	6	6*	0	0	0	C	24	18 ①	24
IL145D60A IL145D60C	1	6	6*	0	0	0	C	24	18 ①	24

① Minimum clearance at least one side for access to rear of furnace.
 * Clearance may be 1 inch when Type B-1 vent is used.
 + Clearance may be 0 inch when Type B-1 vent is used.
 C Floor may be combustible material.

COMBUSTION AND VENTILATION AIR

The furnace and furnace room must have an adequate supply of air for safe combustion and ventilation. The provisions necessary to assure an adequate air supply will vary depending upon differences in the tightness of house construction and in the location of the furnace. Methods of providing air from some typical situations are described below. Consult local codes and ordinances for requirements applicable to your specific furnace installation conditions and comply with them. In the absence of local codes and ordinances, comply with the National Fuel Gas Code, ANSI Z223.1-1980.

EXAMPLE 1 - FURNACE LOCATED IN AN UNCONFINED SPACE

- A. If the furnace is located in a basement or other large, open area of a conventionally built house (loose construction), the air that leaks into the building normally will provide an adequate air supply.
- B. If the furnace is located in a tightly constructed building (storm windows, weather stripping, cracks caulked, etc.) an outdoor air intake must be provided. Example 2, Section B, shows a typical method.

EXAMPLE 2 - FURNACE LOCATED IN A CONFINED SPACE

- A. When the furnace is in a closet or utility room, install two open grilles in a wall or door opening to the rest of the house. One square inch for each 1000 Btu/h of total input rating of all gas appliances in the confined space. Refer to Figure 2. The grilles must communicate with other open areas having adequate air infiltration from outdoors.

If the building is tightly constructed, not enough outside air may enter for safe combustion. Install a fresh air duct from a point near the burners to the outside or to a ventilated attic or crawl space. Refer to Figure 3. This duct must have a free area of at least one square inch for each 4,000 Btu/h of total input of all gas appliances in the space. The minimum dimension of a rectangular duct must not be less than three inches.

CAUTION: WHEN A FURNACE IS INSTALLED IN A CLOSET OR UTILITY ROOM, NEVER USE THIS ROOM AS A RETURN AIR PLENUM.

FIGURE 2 -- FURNACE LOCATED IN CONFINED SPACE

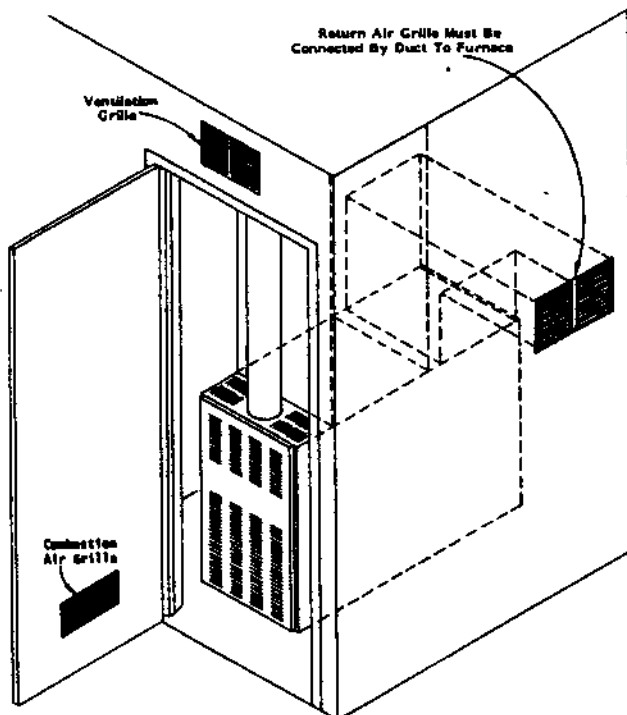
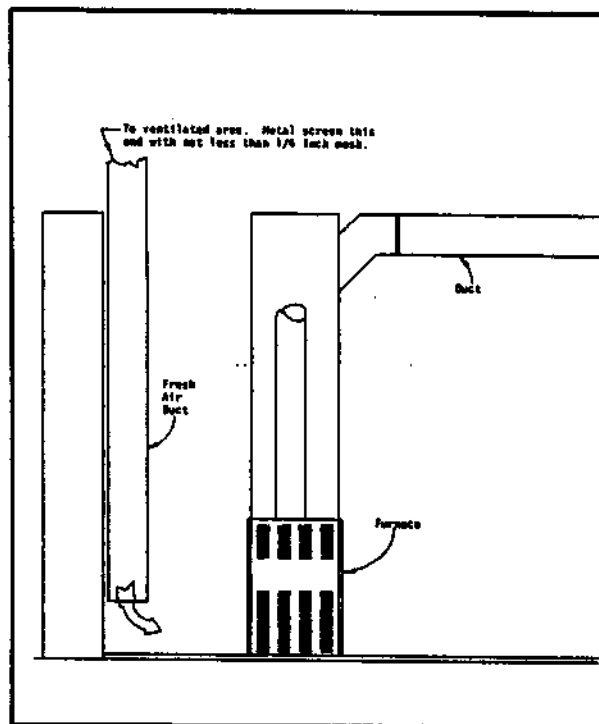

FIGURE 3 -- FRESH AIR DUCT FOR TIGHTLY SEALED BUILDING



VENTING CONNECTIONS

This furnace must be vented directly to the outside through a suitable chimney. This furnace as shipped from the factory is suitable for a dedicated flue only. It should not be vented and terminated horizontally through a side wall and is not suitable for use with plastic pipe. With the addition of optional field-installed Common Venting Kit 8620-005 or -006, it is suitable to common vent this furnace along with another gas burning appliance to a single chimney for ease of installation. Refer to section on Common Venting beginning on page 11 of this instruction manual for complete details. The vent must be installed in compliance with the National Fuel Gas Code (ANSI Standard Z223.1-1980,) and these instructions.

GENERAL INSTRUCTIONS

1. The vent connector must be aluminum pipe and shall be the same size as the flue outlet on the furnace. Keep the vent as short and direct as possible. Type B-1 pipe is recommended.
2. Maintain a minimum clearance of 6" (1" for B-1) to any portion of the vent connector from any adjacent combustible materials. Single wall vent connector is permitted only within the same space (room or area) as the furnace. B-1 vent is required whenever the vent is enclosed or passes through floors, walls, ceilings, roofs or furred-out spaces. Joists, studs, floors, dry wall, paneling, sheathing, rafters, roofing and other materials classified as combustible must not be closer than 1" clearance to the B-1 vent.
3. If connected into masonry chimney, the vent pipe must be inserted into, but not beyond the inside wall of the chimney.
4. The gas vent must extend at least 2 feet above the highest point where it passes through the roof of a building (3 feet for a chimney) and at least 1 foot higher than any portion of a building within a horizontal distance of 10 feet. See Figure 4.
5. The vent pipe system shall be installed so as to avoid excessive turns which create unnecessary resistance to flow of vent gases.

6. Horizontal runs shall be as short and direct as possible. The maximum length of a single-wall vent pipe shall not exceed 75 percent of the height of the vent system. The maximum length of a Type B-1 double wall flue connection shall not exceed 100 percent of the height of the vent system.
7. All horizontal vent pipe shall be pitched upward from the furnace at least 1/4 inch per foot.
8. All vent systems shall be adequately supported to maintain proper clearances, to prevent physical damage, and to prevent separation to joints.
9. Vents passing through an exterior combustible wall must use a ventilated wall thimble. See Figure 5.
10. Vents passing through floors or ceilings must be fire-stopped. See Figure 6 and Figure 7.

GAS SUPPLY AND PIPING

GENERAL RECOMMENDATIONS

1. Be sure the gas line complies with the local codes and ordinances, or in their absence with National Fuel Gas Code, ANSI Z223.1-1980.
2. A sediment trap or drip leg must be installed in the supply line to the furnace.
3. A ground joint union shall be installed in the gas line adjacent to and upstream from the gas valve and downstream from the manual main shut off valve.
4. A 1/8" N.P.T. plugged tapping accessible for test gauge connection shall be installed immediately upstream of the gas supply connection to the furnace for the purpose of determining the supply gas pressure.
5. A manual shut-off valve shall be installed in the supply gas line external to the furnace (see Figure 9 and 10).
6. Use steel or wrought iron pipe and fittings.
7. DO NOT thread pipe too far. Valve distortion or malfunction may result from excess pipe within the control. Use pipe joint compound resistant to the action of Liquefied Petroleum gases on male threads only. DO NOT use Teflon tape. See illustrations below.

LENGTH OF STANDARD PIPE THREADS (Inches)

PIPE SIZE	EFFECTIVE LENGTH OF THREAD	OVERALL LENGTH OF THREAD
3/8	3/8	9/16
1/2	1/2	3/4
3/4	1/2-9/16	13/16
1	9/16	1

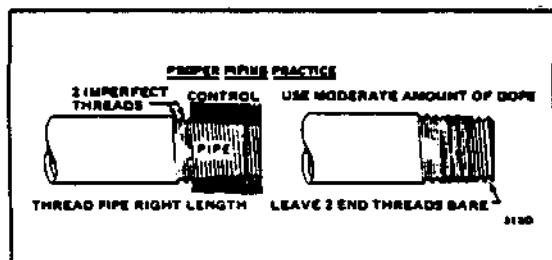

8. Refer to Figure 8 for Gas Pipe sizes for natural gas. If more than one appliance is supplied from a single line size, capacity must equal or exceed the combined input to all appliances, and the branch lines feeding the individual appliances properly sized for each input.

FIGURE 8 -- GAS PIPE SIZES -- NATURAL GAS

Length of Pipe, Ft.	Pipe Capacity -- Btuh Per Hour Input Pipe Size			
	1/2"	3/4"	1"	1-1/4"
10	132,000	278,000	520,000	1,050,000
20	92,000	190,000	350,000	730,000
30	73,000	152,000	285,000	590,000
40	63,000	130,000	245,000	500,000
50	56,000	115,000	215,000	440,000
60	50,000	105,000	195,000	400,000
70	46,000	96,000	180,000	370,000
80	43,000	90,000	170,000	350,000
100	38,000	79,000	150,000	305,000

FIGURE 9 -- TYPICAL PIPING FOR IL-SERIES

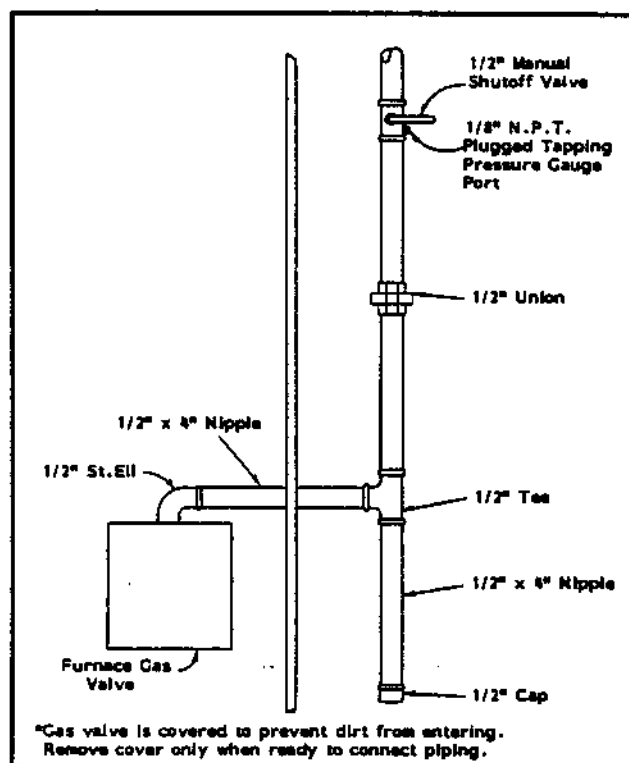

CHECKING THE GAS PIPING

Before turning gas under pressure into piping, all openings from which gas can escape should be closed. **IMMEDIATELY AFTER TURNING ON GAS, the system should be checked for leaks.** This can be done by watching the 1/2 cubic foot test dial and allowing 5 minutes to show any movement, and by soaping each pipe connection and watching for bubbles. If a leak is found, make the necessary repairs immediately and repeat the above test. The furnace must be isolated from the gas supply piping system by closing the manual shutoff valve on the combination gas control valve during pressure testing of the gas supply piping system at pressures up to 1/2 psig. The furnace must be disconnected from supply piping and supply piping capped during any pressure testing of supply piping system at test pressures in excess of 1/2 psig.

Defective pipes or fittings should be replaced and not repaired. **NEVER USE A FLAME OR FIRE IN ANY FORM TO LOCATE GAS LEAKS. USE A SOAP SOLUTION.**

FIG. 4 — CHIMNEY OR VENT CAP INSTALLATION

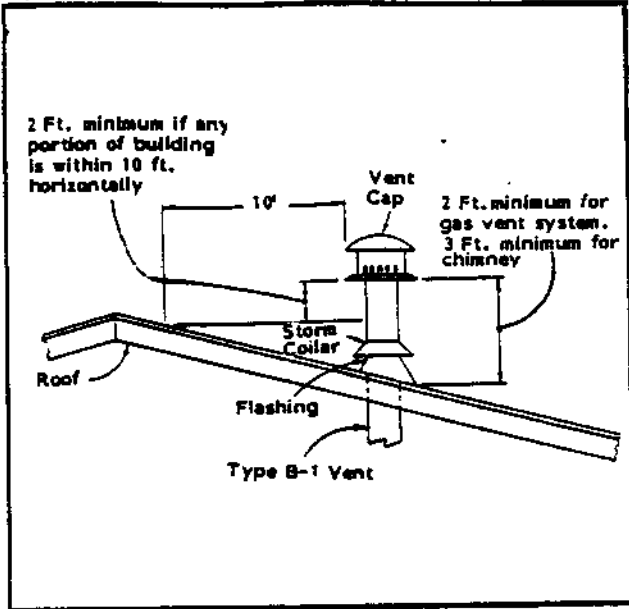
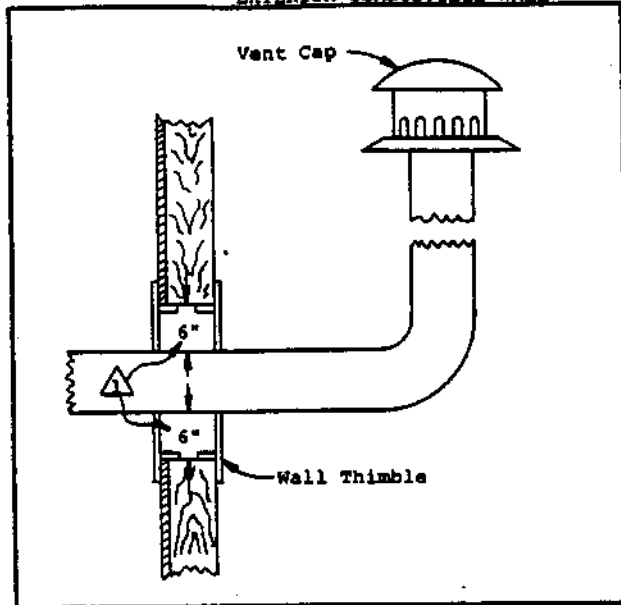

FIG. 5 — VENT PASSING THROUGH AN EXTERIOR COMBUSTIBLE WALL



⚠ Clearance may be 1 inch when Type B-1 vent is used.

FIG. 6 — VENT THROUGH FLOOR

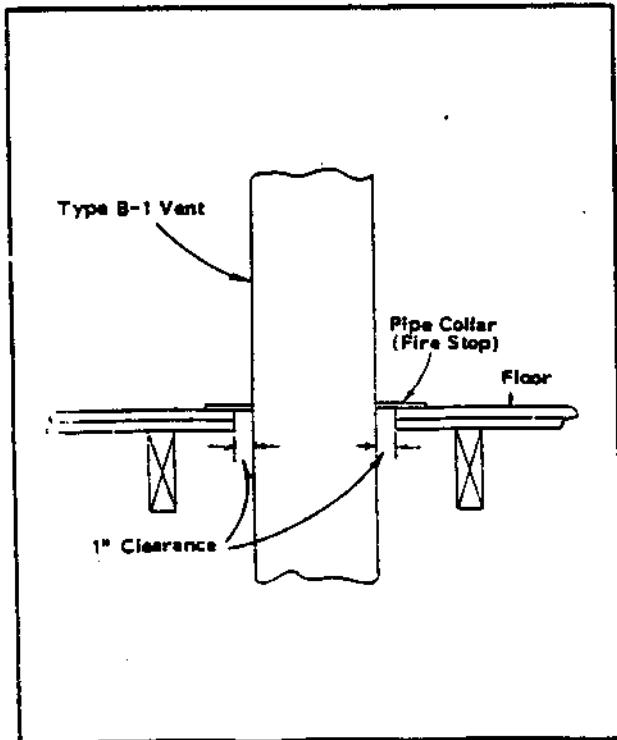
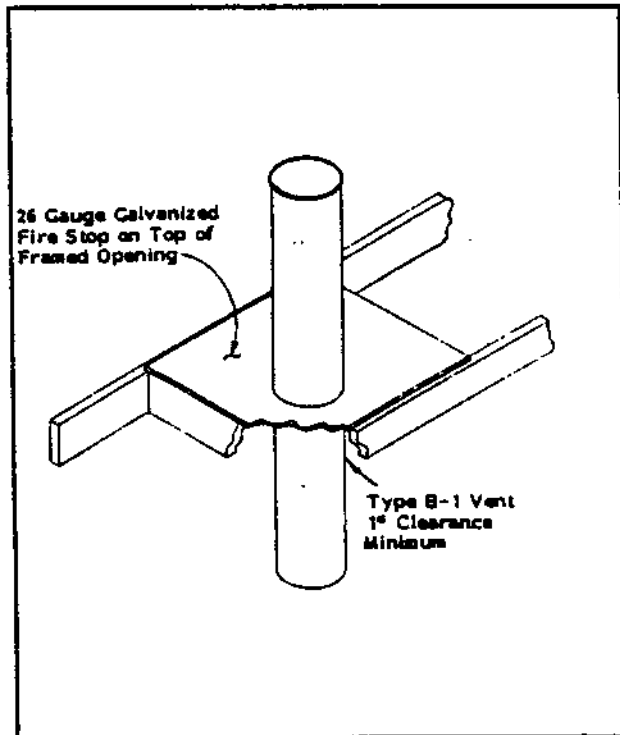

FIG. 7 — VENT THROUGH CEILING



After the piping and meter have been checked completely, purge the system of air. DO NOT bleed the air inside the furnace. Be sure to relight all the gas pilots on other appliances that may have been extinguished because of interrupted gas supply.

WIRING

CAUTION

For your personal safety, turn off electric power at service entrance panel before making any electrical connections.

All electrical work must conform with local codes and ordinances or, in their absence, with the National Electrical Code, ANSI/NFPA 70-1981.

ELECTRICAL POWER SUPPLY

Run a separate 120 volt, 15 ampere, 60 Hz, AC circuit from a separate fuse or circuit breaker in the service entrance panel. Locate a shut off switch at the furnace. Make connections from this switch to furnace junction box as shown in the furnace wiring diagram.

ELECTRICAL GROUNDING

A. Recommended Grounding Method

When installed, the furnace must be electrically grounded in accordance with local codes or in the absence of local codes, with the National Electrical Code, ANSI/NFPA No. 70-1981. Use a #14 Awg copper wire from grounding lug or green ground wire on the furnace to a grounded connection in the service panel or a properly driven and electrically grounded ground rod.

B. Alternate Grounding Method

If the recommended grounding method is impossible, permanently ground the furnace from the ground connector to a grounded cold water pipe using a separate, green colored, insulated conductor of appropriate size. THIS, HOWEVER, IS NOT RECOMMENDED.

NOTE: DO NOT ground to a gas supply pipe. DO NOT connect to electric power supply until appliance is permanently grounded.

THERMOSTAT

Install the thermostat in accordance with instructions packed with it. Locate the thermostat 4-1/3 feet from the floor on an inside wall away from drafts, warm air registers and floor or table lamps. Refer to furnace wiring diagrams for connections.

All 24V wall thermostats have heat anticipators to compensate the thermostat for various system controls and allow the best possible cycle rates. Some anticipators are fixed and require no adjustment. However, the majority of wall thermostats have adjustable anticipators and DO REQUIRE ADJUSTMENT to match the current rating of the gas valve. The anticipator setting should be 0.80A.

Failure to adjust the anticipator lever to correspond to the actual current draw through the thermostat will cause severe short cycling if set too low and room temperature may never attain the thermostat set point, and if set too high, will cause room temperature to overshoot the set point.

BLOWER OPERATION

All models are four speed direct drive models equipped with a heating-cooling blower relay, and when matched with the appropriate wall thermostat offers manual blower operation from the wall thermostat for air circulation.

CAUTION

After the furnace is operating with filters installed and all cabinet panels are in place, check the temperature rise through the unit to insure it is within the range specified on the furnace rating plate. If it is not, adjust blower speed until the temperature rise is within specified range.

FIELD INSTALLED EQUIPMENT

Wiring to be done in the field between the furnace and devices not attached to the furnace, or between separate devices which are field installed and located, shall conform with the temperature limitation for Type T wire [63°F rise (36°C)] when installed in accordance with the manufacturer's instructions. Refer to wiring diagrams.

FILTERS

All models are shipped with filters. See Figure 11 for sizes. See Figure 12 and Figure 13 for filter location.

FIGURE 11 -- FILTER SIZES FOR GAS FURNACES

Model	Size
IL85D42A	(1) 18-3/4 x 20 P
IL115D48A	(1) 22-3/4 x 20 P
IL145D60A	(2) 13 x 20 P

P = Permanent type filter.

FIGURE 12 -- FILTER LOCATION

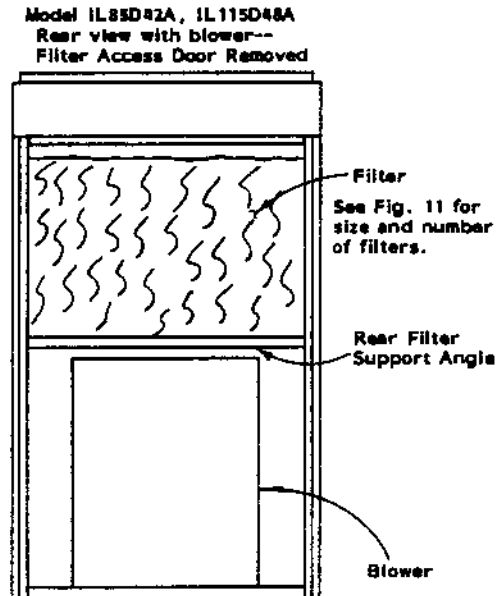

This filter is the permanent high velocity type hog hair which may be washed and used over and over. DO NOT REPLACE IT WITH A FIBERGLASS FILTER OF THE SAME SIZE. To replace filter, reverse the above process.

FILTER 13 -- FILTER LOCATION

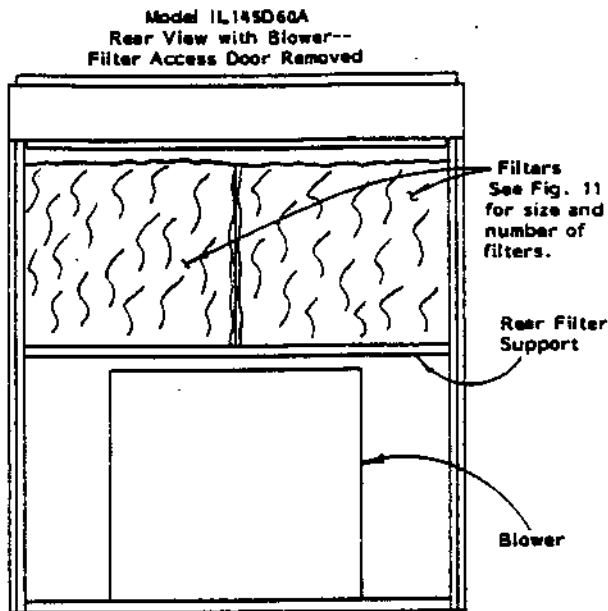

LIGHTING AND SHUTDOWN INSTRUCTIONS

There is one type of ignition system available.

- A. Intermittent Pilot - This is an electric ignition system which lights and proves the pilot flame presence before allowing the main burner to open.

WARNING: Should overheating occur, or the gas supply fail to shut off, shut off the manual gas valve to the appliance before shutting off the electrical supply.

INTERMITTENT PILOT

TO SHUT DOWN FURNACE:

1. Set thermostat, lowest setting.
2. Turn gas valve to OFF position.
3. Switch off electric supply to furnace.

OPERATING INSTRUCTIONS:

1. Set the thermostat to lowest setting, electric supply and gas valve to OFF position and wait five minutes.
2. Turn gas valve ON, restore electric power and set room thermostat. Setting must be above room temperature to start burner operation.
3. DO NOT attempt to manually light the pilot, it will light automatically.
4. If the burner fails to ignite, repeat steps 1 through 4 of the operating instructions.
5. If the burner again fails to ignite, shut down the furnace and have qualified service personnel investigate the problem.

SEQUENCE OF OPERATION

On a call for heat from the thermostat the DPST relay coil is energized through the normally closed contact of the air proving pressure switch. When the relay coil is energized, the relay contacts close which simultaneously energizes the induced draft blower and locks in the relay coil. Once sufficient draft is established, the ignition module will be energized through the normally open contact of the pressure switch. The pilot ignition electrode will begin to spark and pilot valve will be energized allowing pilot gas flow. Upon establishment of pilot burner flame, adequate flame for burner ignition is proved to control module at which point main gas valve is energized and spark is discontinued.

MAINTENANCE INSTRUCTIONS

The furnace and its vent system should be inspected annually by a qualified service agency, generally prior to the heating season.

NOTE: PRIOR TO THE START OF ANY OF THE FOLLOWING MAINTENANCE PROCEDURES SHUT OFF ALL POWER TO THE UNIT.

Routine maintenance procedures are the responsibility of the owner and are contained in the Owner's Manual. These are briefly outlined below:

1. Air Filters. Check the condition on at least a monthly basis when the furnace is in use or replace whenever it is necessary.
2. Lubrication Requirements. Direct drive motors are permanently lubricated, no maintenance required. The induced draft blower motor should be oiled every six months with SAE20 motor oil.
3. Check Temperature Rise. Adjust blower speed if necessary to obtain a temperature rise within the range specified on the furnace rating plate.
4. Basic Examination of Furnace. Visual inspection of pilot flame and the main burners. Also inspection of the burner compartment and the vent system for sooting and scaling.
5. Periodic Inspection of the Vent System. Visual inspection of the vent system from the furnace to the chimney for any leaking or defective parts.

SERVICE AGENCY PROCEDURES

1. The intermittent pilot lights only when the thermostat calls for heat and the main burner lights within a few seconds thereafter. It is recommended that any observation of pilot or main burner operation be done only with the burner compartment door in place and viewing through the combustion air slots.

The pilot flame can be adjusted by removing the pilot adjustment cover screw. Turn inner adjustment screw clockwise to decrease and counterclockwise to increase pilot flame. Be sure to replace cover screw after adjustment to prevent possible gas leakage.

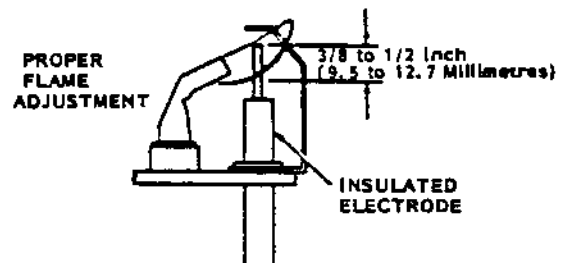

INTERMITTENT PILOT

2. Observe the main burners in operation, viewing through the combustion air slots. The flame should be mostly "blue" with possibly a little orange (not yellow) at the tips of the flames. The flames should be in the center of the heat exchanger compartments and not impinging on the heat exchanger surfaces themselves.

Observe the fire until the blower starts (there is a normal delay period until the heat exchanger warms up). There should be no change in the size or shape of the flame. If there is any wavering or blowing of the flame on blower start-up, it is an indication of a possible leak in the heat exchanger.

The air shutters are factory adjusted completely open. If flashback occurs, the air shutters may be closed slightly to prevent the flashback.

REPLACEMENT PARTS

Replacement parts for the gas furnaces are available through local distributor.

Parts list covering all of the normally serviceable items are shown on page 9. When ordering parts or making inquiries pertaining to any of the furnaces covered by these instructions, it is very important to always supply the COMPLETE model number and serial number of the furnace. This is necessary to assure that the correct parts (or an approved alternate part) are issued to the service agency.

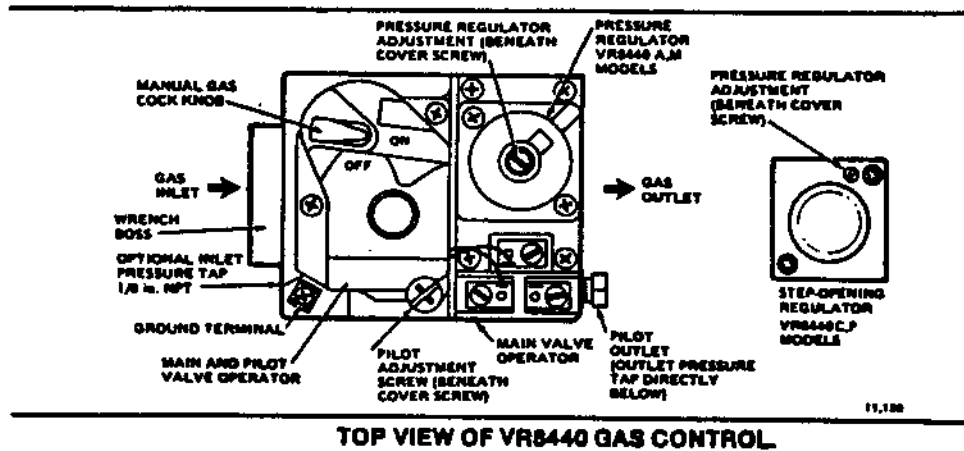

CONNECTION DIAGRAM
DANGER: ELECTRICAL SHOCK HAZARD, DISCONNECT POWER BEFORE SERVICING.

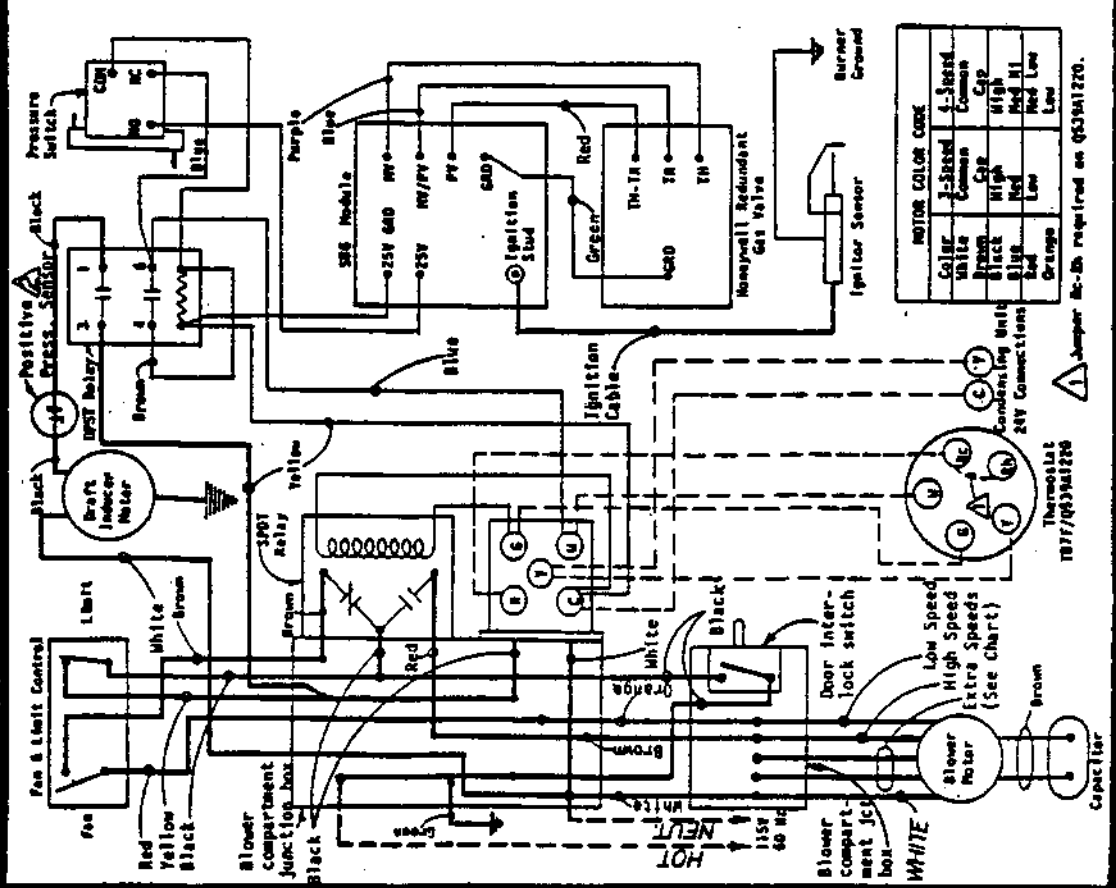

IF ANY OF THE ORIGINAL WIRE AS SUPPLIED WITH THE APPLIANCE MUST BE REPLACED, IT MUST BE REPLACED WITH WIRING MATERIAL HAVING A TEMPERATURE RATING OF AT LEAST 105°C., EXCEPT THE IGNITION CABLE WHICH IS 250°C. HIGH VOLTAGE CABLE.

LADDER DIAGRAM

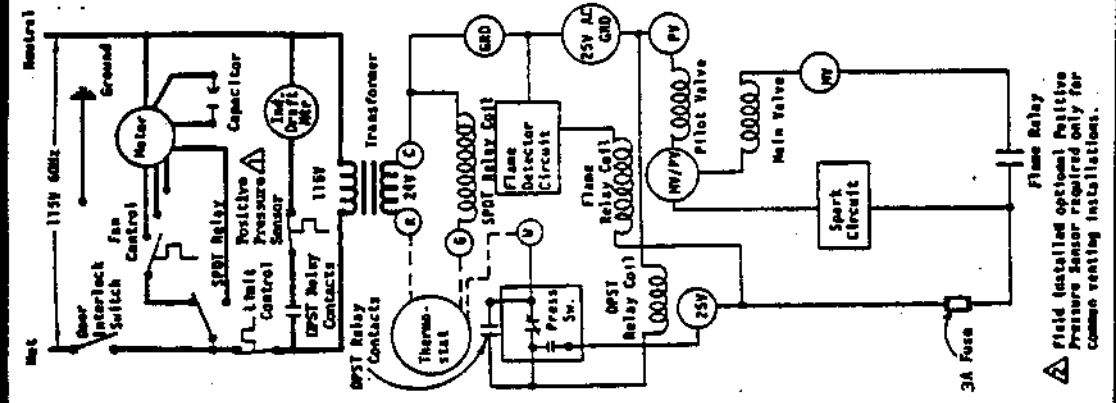

Field installed optional Positive Pressure Sensor required only for common venting installations.

FACTORY WIRING **FIELD WIRING**
 Low Voltage High Voltage

S86 MODULE
NORMAL SEQUENCE OF OPERATION

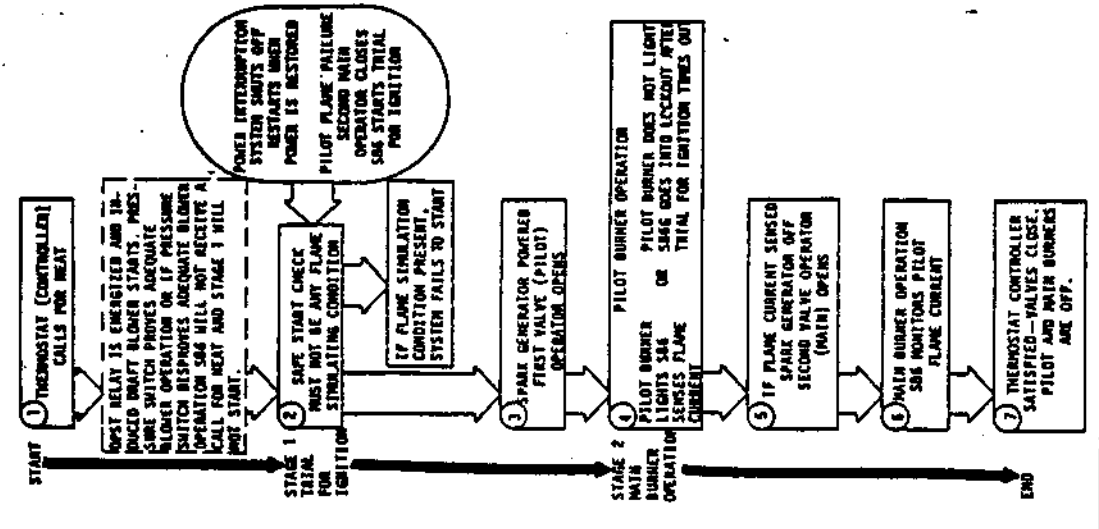

3 & 4 SPEED MODELS, ELECTRIC IGNITION
 4046-107
 IL-SERIES WIRING DIAGRAM

PARTS LIST
HIGH ECONOMY GAS FURNACE
Lo-Boy

8/84

Part No.	Description	IL85D42A, C	IL115D48A, C	IL145D60A, C
8552-002	Capacitor 5/370V	x		
8552-004	Capacitor 7.5/370V		x	
8552-026	Capacitor 15/370V			x
8402-007	Fan and Limit 8"	x	x	
8402-001	Fan and Limit 11"			x
7003-014	Filter - 18-3/4 x 20 P	x	x	
7003-015	Filter - 22-3/4 x 20 P			x
7003-016	Filter - 13 x 20 P			x
9041-033	Heat Exchanger	x		
9041-034	Heat Exchanger		x	
9041-035	Heat Exchanger			x
*	Housing - Blower 10-9	x		
*	Housing - Blower 10-10		x	
8600-002	Ignition Wire	x	x	x
8109-001	Induced Draft Blower	x	x	x
5818-002	Manifold NS3	x		
5818-003	Manifold NS4		x	
5818-004	Manifold NS5			x
8406-013	Micro Switch	x	x	x
8105-009	Motor 1/3 hp	x		
8106-018	Motor 1/2 hp		x	
8107-004	Motor 3/4 hp			x
8200-003	Motor Mount	x	x	
8200-026	Motor Mount			x
5451-011	Motor Mounting Parts	x	x	
9010-010	Orifice - Nat	x	x	x
8554-009	Pilot and Orifice - Nat	x	x	x
5651-024	Ignition Module	x	x	x
8406-021	Pressure Switch	x	x	x
8201-013	Relay - DPST	x	x	x
8201-006	Fan Relay w/Trans.	x	x	x
5651-023	Valve - Nat. 1/2 x 3/4	x	x	x
9010-016	Venturi 3 Cell	x		
9010-017	Venturi 4 Cell		x	
9010-018	Venturi 5 Cell			x
5152-014	Wheel DD10-9A (blower)	x		
5152-015	Wheel DD10-10A (blower)		x	
5152-050	Wheel and Housing Assembly			x

*Please order by model number.
 Minimum net billing \$15.00. Supersedes all previous lists.
 Subject to change without notice.

586 INTERMITTENT PILOT SYSTEM TROUBLESHOOTING TABLE

START

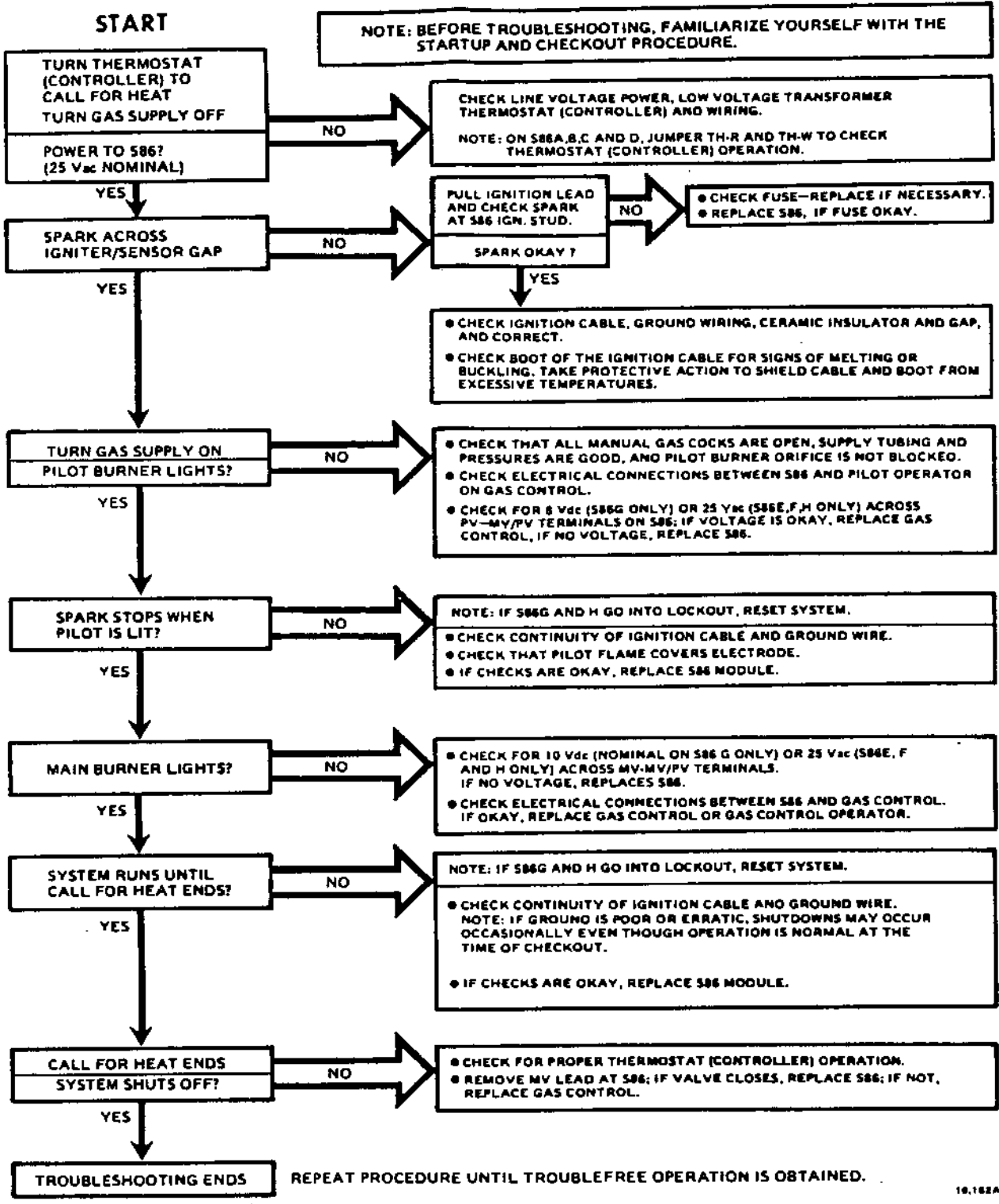

19,182A

COMMON VENTING REQUIREMENTS

For common venting this furnace with another gas burning appliance the addition of a Common Venting Kit is required. This kit is field installed by the installing contractor following the instructions packaged with the kit. It is a very simple procedure requiring only the removal and reinsertion of two screws and the reconnection of one wire. The kits that are required are detailed below:

Furnace Model	Input Rating, Btu/Hour	Common Venting Kit No.
IL85D42A, C	86,000	8620-006
IL115D48A, C	115,000	8620-006
IL145D60A, C	145,000	8620-006

There are some minimum specifications that apply to the common venting system design. These are outlined below with additional reference made to the illustrations as shown:

Furnace Model	Minimum Total Vent Height "H"	Furnace Vent Connector Size	Minimum Common Vent Pipe Connector	
			3" Water Heater	4" Water Heater
IL85D42A, C	8'	3"	4"	4"
IL115D48A, C	8'	4"	5"	5"
IL145D60A, C	8'	4"	5"	5"

See the following Figure illustrations for common venting arrangements:

Furnace Model	Vented With 3" Water Heater	Vented With 4" Water Heater
IL85D42A, C	Fig. 12, 13	Fig. 14, 15
IL115D48A, C	Fig. 16, 17	Fig. 16, 17
IL145D60A, C	Fig. 16, 17	Fig. 16, 17

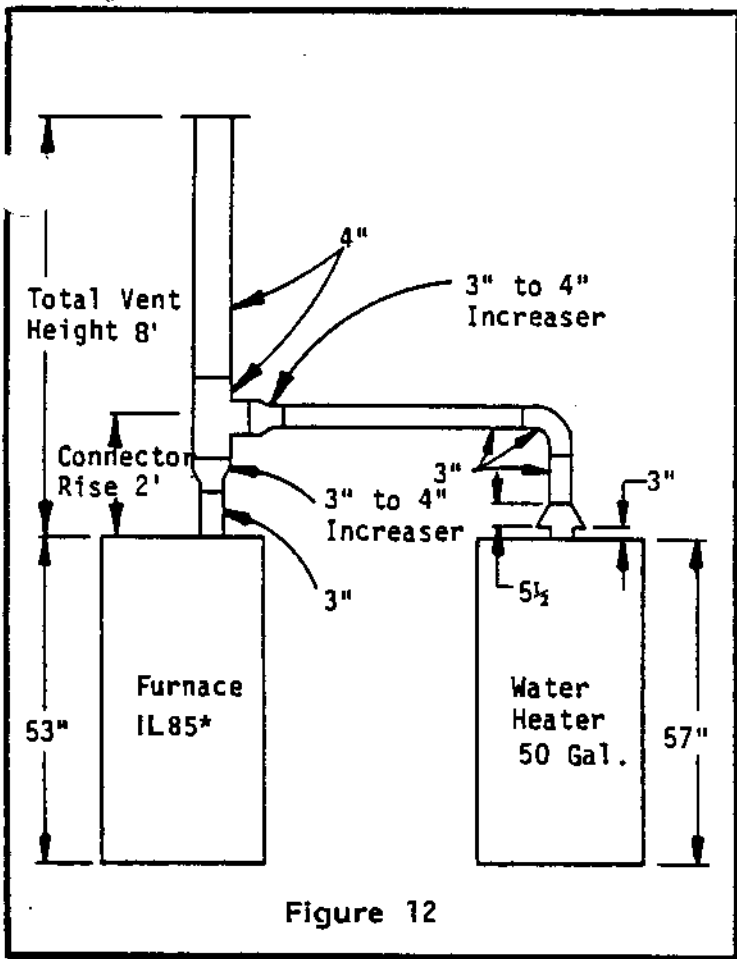

*With Additional Suffix

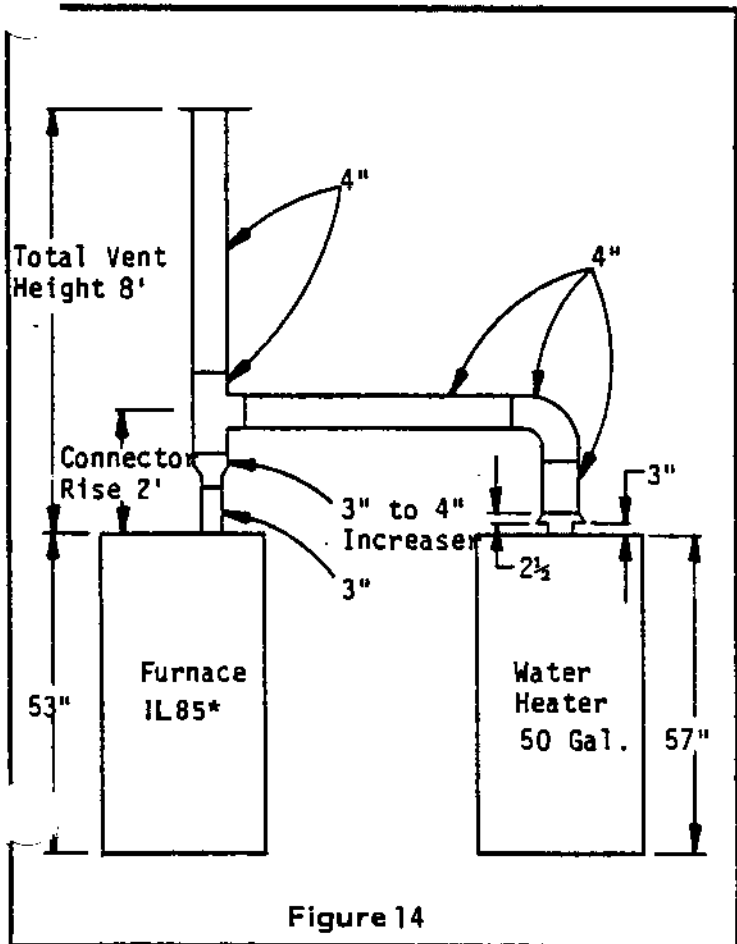
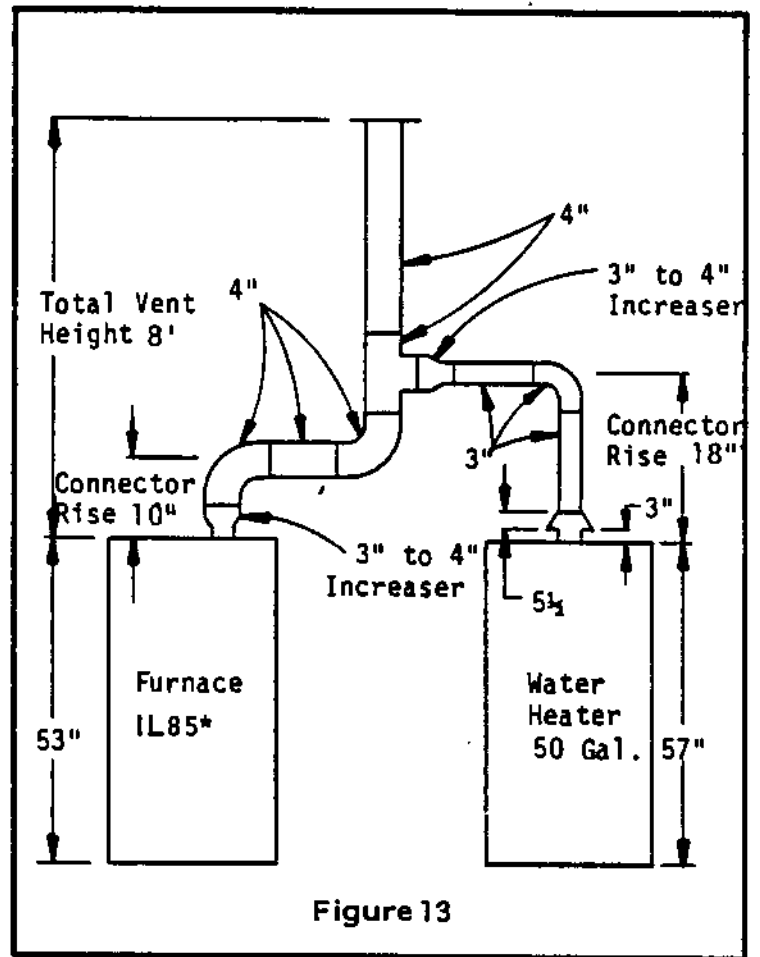

*With Additional Suffix

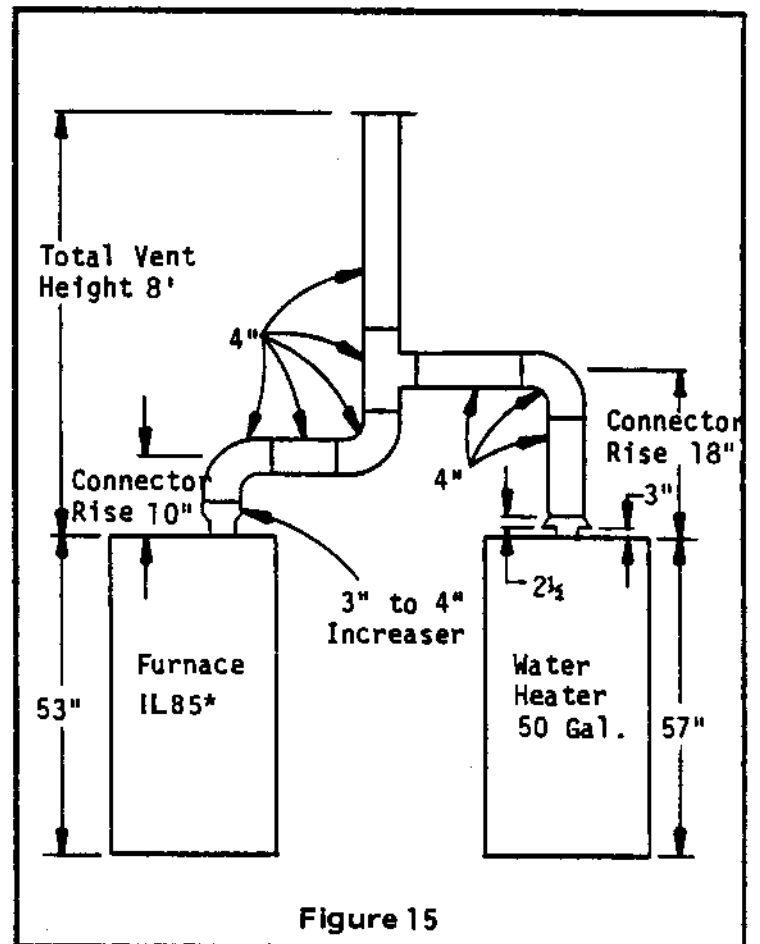

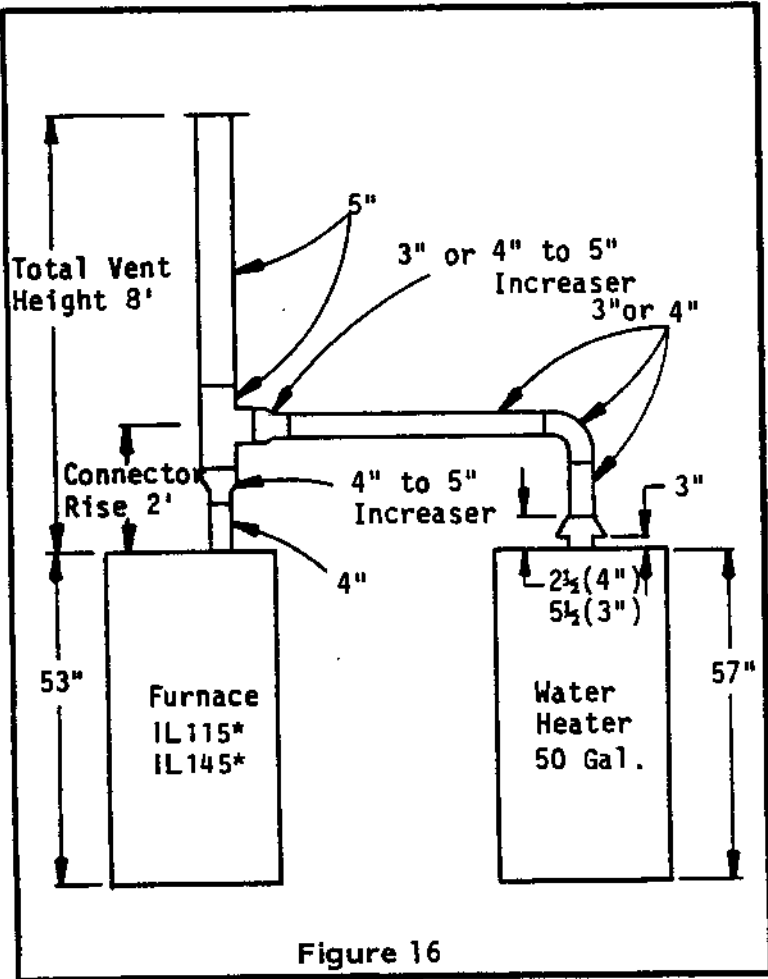

Figure 16

*With Additional Suffix

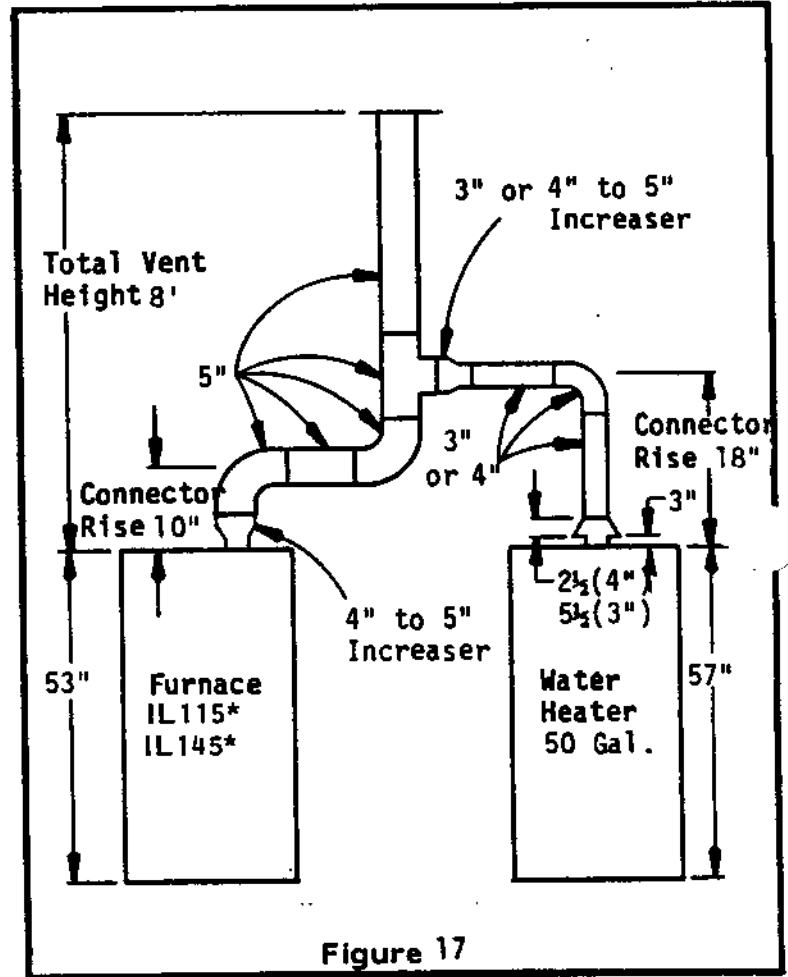

Figure 17