

INSTALLATION INSTRUCTIONS

MODELS

| | |
|------------|------------|
| 24UACS, QA | 42UACSA-B |
| 30UACS, QA | 48UACS, QA |
| 36UACS, QA | 48UACSA-B |
| 36UACSA-B | 60UACS, QA |
| 42UACS, QA | 60UACSA-B |

SPLIT AIR CONDITIONER
OUTDOOR SECTION

FOR USE WITH:
MATCHING INDOOR BLOWER
COIL UNITS AND MATCHING
ADD ON COIL UNITS ONLY



NOMENCLATURE EXPLANATION - Example:

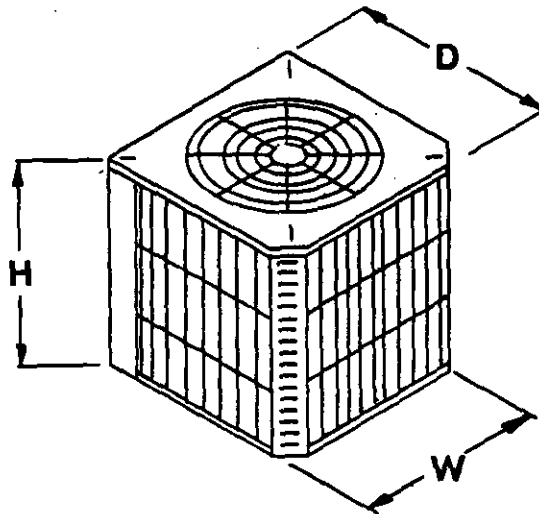
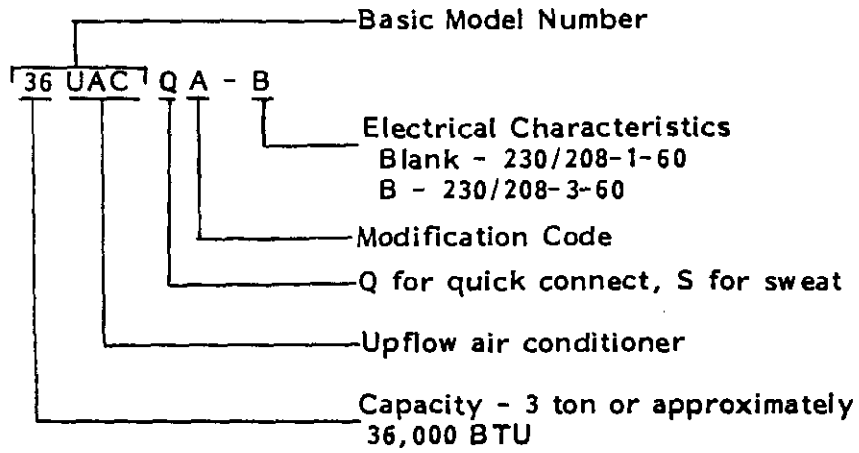

| DIMENSIONS | | | |
|-----------------|-----------|-----------|------------|
| Basic Model No. | "W" Width | "D" Depth | "H" Height |
| 24UAC | 32-1/2" | 32-1/2" | 26" |
| 30UAC | | | |
| 36UAC | | | |
| 42UAC | | | |
| 48UAC | | | |
| 60UAC | | | 36" |

RATED CFM AND AIR FLOW DATA (Wet Coil - Cooling)

| Condensing Unit Model Number | Evaporator Coil Model Number | Rated Airflow | | Rated E.S.P. ② | Motor Speed Tap | Recommended Air Flow Range |
|---------------------------------|------------------------------|---------------|------------------------------------|----------------|-----------------|----------------------------|
| | | CFM | Pressure Drop "H ₂ O" ① | | | |
| 24UACQA 24UACSA | A18AQ-A A18AS-A | 750 | .20 | | | 640 - 825 |
| | A30AQ-A A30AS-A | 825 | .15 | | | 700 - 910 |
| | B24EHQ1 | 785 | | .20 | High | 670 - 860 |
| | 3HCQ1 | 800 | .20 | | | 680 - 880 |
| 30UACQA 30UACSA | A30AQ-A A30AS-A | 1000 | .20 | | | 850 - 1100 |
| | B36EHQ1 | 1025 | | .40 | Low | 870 - 1300 |
| | 3HCQ1 | 1000 | .30 | | | 850 - 1100 |
| 36UACQA 36UACSA 36UACSA-B | A30AQ-A A30AS-A | 1125 | .30 | | | 950 - 1240 |
| | A36AQ-A A36AS-A | 1200 | .30 | | | 1020 - 1320 |
| | A42AQ-A A42AS-A | 1380 | .30 | | | 1170 - 1520 |
| | A48AQ-A A48AS-A | 1450 | .27 | | | 1230 - 1600 |
| | B36EHQ1 | 1200 | | .30 | High | 1020 - 1320 |
| | 3HCQ1 | 950 | .30 | | | 900 - 1050 |
| | 4HCQ | 1300 | .25 | | | 1170 - 1450 |
| | | | | | | |
| 42UACQA 42UACSA 42UACSA-B | A42AQ-A A42AS-A | 1325 | .30 | | | 1125 - 1450 |
| | A48AQ-A A48AS-A | 1525 | .30 | | | 1300 - 1675 |
| | BC48A | 1525 | | .20 | Low | 1300 - 1675 |
| | BC60A | 1640 | | .40 | High | 1400 - 1800 |
| | 4HCQ | 1200 | .30 | | | 1020 - 1320 |
| | 5HCQ | 1500 | .30 | | | 1275 - 1650 |
| | | | | | | |
| 48UACQA 48UACSA 48UACSA-B | A42AQ-A A42AS-A | 1325 | .30 | | | 1125 - 1450 |
| | A48AQ-A A48AS-A | 1525 | .30 | | | 1300 - 1675 |
| | BC48A | 1700 | | .30 | High | 1450 - 1875 |
| | BC60A | 1750 | | .30 | High | 1485 - 1925 |
| | 4HCQ | 1300 | .30 | | | 1170 - 1450 |
| | 5HCQ | 1375 | .30 | | | 1170 - 1500 |
| | | | | | | |
| 60UACQA 60UACSA 60UACSA-B | A48AQ-A A48AS-A | 1500 | .30 | | | 1275 - 1650 |
| | A60AQ-A A60AS-A | 1900 | .30 | | | 1615 - 2100 |
| | BC48A | 1700 | | .30 | High | 1450 - 1875 |
| | BC60A | 1800 | | .20 | High | 1525 - 1975 |
| | 5HCQ | 1600 | .30 | | | 1360 - 1760 |
| | | | | | | |

① Measured across the evaporator coil assembly, including drain pan.

② External static pressure available for the duct system - supply and return. All blower coils have multi-speed motors, and value shown is at the recommended rated speed. Consult specification air flow charts with the blower coil units for complete information at other speeds.

APPLICATION AND INSTALLATION INSTRUCTIONS

GENERAL

These instructions explain the recommended method to install the air cooled remote type condensing unit, the inter-connecting refrigerant tubing and the electrical wiring connections to the unit.

The condensing units are to be used in conjunction with the matching evaporator coils or evaporator blower units for comfort cooling applications as shown in the specification sheet.

These instructions and any instructions packaged with any separate equipment required to make up the entire air conditioning system should be carefully read before beginning the installation. Note particularly "Connecting Quick-Connect Couplings, Starting Procedure" and any tags and/or labels attached to the equipment.

While these instructions are intended as a general recommended guide, they do not supersede any national and/or local codes in any way. Authorities having jurisdiction should be consulted before the installation is made.

SHIPPING DAMAGE

Upon receipt of equipment, the carton should be checked for external signs of shipping damage. If damage is found, the receiving party must contact the last carrier immediately, preferably in writing, requesting inspection by the carrier's agent.

INSTALLATION

Size of unit for a proposed installation should be based on heat loss calculation made according to methods of National Warm Air Heating and Air Conditioning Association. The air duct should be installed in accordance with the Standards of the National Fire Protection Association for the Installation of Air Conditioning and Ventilating Systems of Other Than Residence Type, NFPA No. 90A, and Residence Type Warm Air Heating and Air Conditioning Systems, NFPA No. 90B. Where local regulations are at a variance with instructions, installer should adhere to local codes.

LOCATION

The condensing unit is designed to be located outside with free and unobstructed condenser air inlet and discharge. It must also permit access for service and installation. Condenser

air enters the coil on three sides and discharges upward from the top. Refrigerant and electrical connections are made from the rear of the unit as shown in figure 1 with electrical service access on the right side. The unit can be installed with the rear of the unit "close to the wall", however, additional service clearance at the back of the unit would be desirable if practical for unit service. The compressor can be serviced through the top.

MOUNTING UNIT OUTSIDE ON SLAB

A solid level base or platform, capable to support the unit's weight, must be set at the outdoor unit predetermined location. The base should be at least two inches larger than the base dimensions of the unit and at least two inches higher than the surrounding grade level. The required unit minimum installed clearances must be maintained as called out in Figure 1 when locating and setting the base.

Remove the unit from its shipping carton and position the unit on the prepared base or platform.

Do not attach the unit or its base to the building structure to avoid the transmission of noise into the occupied area.

NOTE: These units employ internally sprung compressors; therefore, it is not necessary to remove or loosen the base mounting bolts on the compressor prior to operation.

Consideration should be given to the electrical and tubing connections when placing the unit to avoid unnecessary bends or length of material.

WIRING

All wiring must be installed in accordance with the National Electrical Code and local codes. Power supply voltage must conform to the voltage shown on the unit serial plate. A wiring diagram of the unit is attached to the inside of the electrical cover. The power supply shall be sized and fused according to the specifications supplied. A ground lug is supplied in the control compartment for equipment ground.

The control circuit is a 24 volt circuit. "Typical" wiring diagrams illustrating some of the various circuits which could be encountered can be found later in the manual.

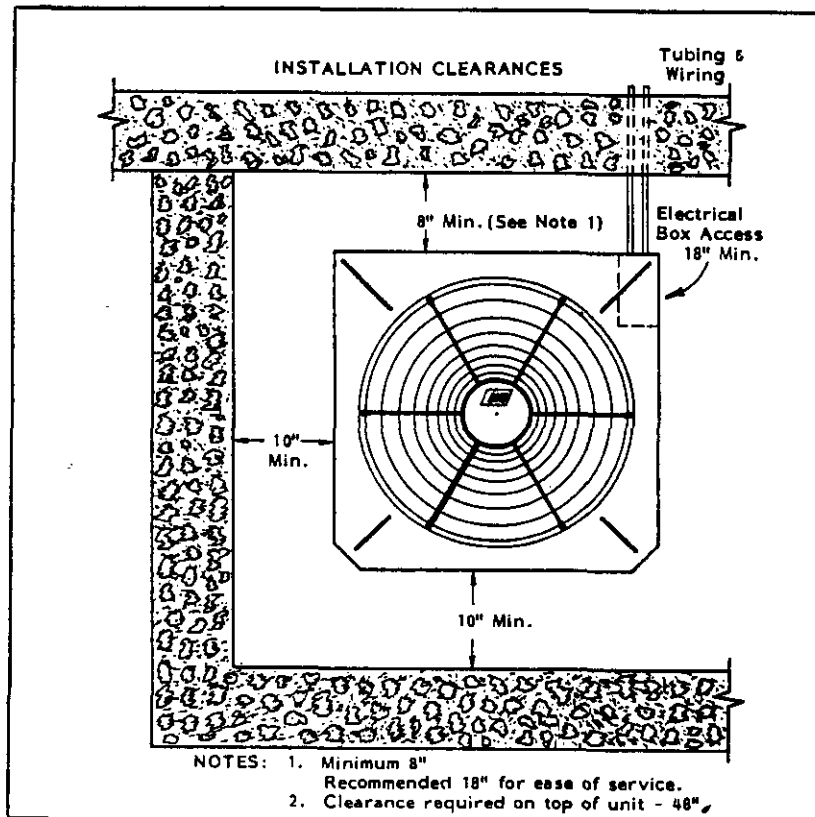

FIGURE 1.

The unit rating plate lists a "Maximum Time Delay Fuse" or "HACR Type" circuit breaker that is to be used with the equipment. The correct size must be used for proper circuit protection and also to assure that there will be no nuisance tripping due to the momentary high starting current of the compressor motor.

When matching with a B-model blower coil unit, refer to the installation instructions with that indoor unit for 24V wiring information.

PRESSURE SERVICE PORTS

High and low pressure service ports are installed on all units so that the system operating pressures can be observed. Pressure curves can be found later in the manual covering all models. It is imperative to match the correct pressure curve to the unit by model number.

The pressure service ports on the split system air conditioners are located on the inter-connecting tubing quick connect fittings or, on the base valves.

CRANKCASE HEATERS

All models have an insertion well-type heater located in the lower section of the compressor housing. This is a self-regulating type heater that draws only enough power to maintain the compressor at a safe temperature.

Crankcase heat is essential to prevent liquid refrigerant from migrating to the compressor, causing oil pump out on compressor start-up and possible valve failure due to compressing a liquid.

The following decal is affixed to all outdoor units detailing start-up procedure. This is very important. Please read carefully.

IMPORTANT

THESE PROCEDURES MUST BE FOLLOWED AT INITIAL START-UP AND AT ANY TIME POWER HAS BEEN REMOVED FOR 12 HOURS OR LONGER.

TO PREVENT COMPRESSOR DAMAGE WHICH MAY RESULT FROM THE PRESENCE OF LIQUID REFRIGERANT IN THE COMPRESSOR CRANKCASE

1. MAKE CERTAIN THE ROOM THERMO STAT IS IN THE OFF POSITION (THE COMPRESSOR IS NOT TO OPERATE).
2. APPLY POWER BY CLOSING THE SYSTEM DISCONNECT SWITCH THIS ENERGIZES THE COMPRESSOR HEATER WHICH EVAPORATES THE LIQUID REFRIGERANT IN THE CRANKCASE.
3. ALLOW 4 HOURS OR 80 MINUTES PER POUND OF REFRIGERANT IN THE SYSTEM AS NOTED ON THE UNIT RATING PLATE WHICHEVER IS GREATER.
4. AFTER PROPERLY ELAPSED TIME THE THERMOSTAT MAY BE SET TO OPER THE COMPRESSOR.
5. EXCEPT AS REQUIRED FOR SAFETY WHILE SERVICING - DO NOT OPEN SYSTEM DISCONNECT SWITCH.

7/901 U01

FAN BLADE SETTING DIMENSIONS

Shown in the drawing below are the correct fan blade setting dimensions for proper air delivery across the outdoor coil.

Any service work requiring removal or adjustment in the fan and/or motor area will require that the dimensions below be checked and blade adjusted in or out on the motor shaft accordingly.

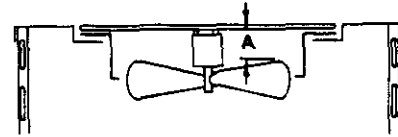

| MODEL | DIMENSION A |
|---------------|-------------|
| 24, 30, 36UAC | 3-1/2 |
| 42, 48UAC | 4 |
| 60UAC | 4 |

IMPORTANT INSTALLER NOTE:

For improved start-up performance, wash the indoor coil with a dishwasher detergent.

INDOOR COIL

These units are designed to match with all indoor blower coils, horizontal coils and "A" coils shown earlier in these instructions. All blower and horizontal coils are produced with capillary tube type refrigerant control. All "A" coils shown are produced with an interchangeable brass orifice to provide optimum matching of the refrigerant control when matching alternate sized "A" coils to the outdoor unit. A properly sized orifice for each outdoor section is packaged with this unit. See installation instructions packaged with the "A" coils for complete details.

| ELECTRICAL DATA | | | | | | | | | | |
|--|------------|-----------|-----------|-----------|------------|-----------|-----------|-----------|------------|-----------|
| MODEL | 24UAC*A | 30UAC*A | 36UAC*A | 36UACSA-B | 42UAC*A | 42UACSA-B | 48UACQA | 48UACSA-B | 60UACQA | 60UACSA-B |
| ELECTRICAL RATING (60Hz/V/Ph) | 230/208-1 | | | 230/208-3 | 230/208-1 | 230/208-3 | 230/208-1 | 230/208-3 | 230/208-1 | 230/208-3 |
| Operating Voltage Range | 197-253 | | | 187-253 | 197-253 | 187-253 | 197-253 | 187-253 | 197-253 | 187-253 |
| Minimum Circuit Ampacity | 15 | 19 | 22 | 15 | 27 | 18 | 29 | 19 | 39 | 28 |
| +Field Wire Size | #14 | #12 | #10 | #14 | #10 | #12 | #10 | #12 | #8 | #10 |
| ++Delay Fuse Max. or Ckt. Bkr. | 20 | 30 | 35 | 25 | 45 | 30 | 45 | 30 | 60 | 40 |
| Total Unit AMPS 230/208 | 8.6/9.6 | 11.6/12.6 | 15.6/17.6 | 10.4/11.7 | 18/20.5 | 12.5/13.6 | 19.5/22 | 13.4/14.7 | 24.8/27.3 | 20.6/22.3 |
| COMPRESSOR | | | | | | | | | | |
| Rated Load Amps 230/208 | 7.5/8.5 | 10.5/11.7 | 14.5/16.5 | 8.9/10.3 | 16.5/19 | 11.0/12.1 | 18/20.5 | 11.9/13.2 | 22.5/25 | 18.3/20 |
| Branch Ckt. Selection Current | 9.3 | 14.1 | 18.5 | 10.8 | 20.2 | 12.9 | 21.5 | 13.8 | 28.9 | 20 |
| Lock Rotor Amps 230/208 | 50/50 | 66/66 | 75.8/75.8 | 65/65 | 93/93 | 74/74 | 95.4/95.4 | 82/82 | 138/138 | 103/103 |
| FAN MOTOR & CONDENSER | | | | | | | | | | |
| Fan Motor - HP/RPM | 1/6 - 825 | | | | 1/4 - 825 | | | | 1/3 - 1075 | |
| Fan Motor -- AMPS | 1.1 | | | | 1.5 | | | | 2.3 | |
| Fan - DIA/CFM | 24" - 3000 | | | | 28" - 3100 | | | | 24" - 3100 | |
| + 60°C Copper wire size. ++Maximum time delay fuse or HACR type circuit breaker. *Applies to sweat and quick connect type. | | | | | | | | | | |

TABLE 1

INSTALLING REFRIGERANT TUBING

(Applicable to "S" models)

Use only refrigeration grade (dehydrated and sealed) copper tubing of the size indicated below (Table 2). Care must be taken to insure that the tubing is kept clean and dry before and during installation. DO NOT remove the plugs from the tubing ends, coil connections or base valves until the connection is ready to be made.

Insulate the suction line with a minimum of 3/8" Armaflex or equivalent. Install the insulation to the suction line before cutting and making connections.

| Basic Condensing Unit Model | REFRIGERANT LINE LENGTH (Ft.) | | |
|-----------------------------------|-------------------------------|--------------|--------------|
| | 0-20 | 21-60 | 61-100 |
| | Liq. & Suct. | Liq. & Suct. | Liq. & Suct. |
| 24UAC | 3/8 & 5/8 | 3/8 & 3/4 | 3/8 & 3/4 |
| 30UAC | 3/8 & 5/8 | 3/8 & 3/4 | 3/8 & 3/4 |
| 36UAC | 3/8 & 5/8 | 3/8 & 3/4 | 1/2 & 7/8 |
| 42UAC | 3/8 & 3/4 | 3/8 & 7/8 | 1/2 & 7/8 |
| 48UAC | 3/8 & 7/8 | 3/8 & 7/8 | 1/2 & 1-1/8 |
| 60UAC | 3/8 & 7/8 | 3/8 & 7/8 | 1/2 & 1-1/8 |

TABLE 2

INSTALLING REFRIGERANT TUBING

(Pre-charged - applicable to "Q" models)

PRE-CHARGED TUBING - Examine carefully the two lengths of pre-charged tubing furnished with the unit. The larger is the suction line. The smaller is the liquid line. The end of the tubing with the hex nut and gauge port is to be attached to the condensing unit.

Unroll the tubing, being careful not to kink, and install it between the condensing unit and the evaporator coil.

CAUTION: Be careful not to tear the insulation when pushing it through holes in masonry or frame walls.

When sealing tube opening in house wall use a soft material to prevent tube damage and vibration transmission.

Before fastening either end, use a tubing bender to make any necessary bends in the tubing. **AVOID EXCESSIVE BENDING IN ANY ONE PLACE TO AVOID KINKING.**

Start connecting the tubing at the evaporator coil end, first remove the protective caps and plugs from the quick-connect fittings on the evaporator coil and the pre-charged tubing. Inspect fittings and clean if necessary, making sure they are clear of foreign materials. If you clean the fittings, lubricate them with refrigeration oil. Connect both tubes to the fittings on the coil and draw up by hand.

When necessary to bend the insulated tube, suction line, cut the insulation around its circumference at a distance far enough beyond the point of the bend so as to clear the tubing bender.

Slip the insulation back together and vapor seal the joint with tape.

NOTE: The maximum distance for pre-charge tubing between the condenser and the evaporator is 45 feet.

CAUTION: Prior to connecting the pre-charged tubing to the evaporator coil or condensing unit, be sure all bends have been made, then coil any excess tubing in a horizontal plane, with the slope of the tubing toward the condensing unit.

CAUTION: Be sure to hold the coupling firmly to prevent movement of the coupling and tubing. Failure to do so could tear out the diaphragm causing a blockage of the system.

CAUTION: After starting to tighten up the fitting never try to back it off or take it apart.

For connecting the tubing at the condensing unit end, first remove the protective caps and plugs from the quick-connect fittings on the condensing unit and the pre-charged tubing. Inspect fittings and clean if necessary, making sure they are clear of foreign materials. If you clean the fittings, lubricate them with refrigeration oil. Connect both tubes to the fittings on the coil and draw up by hand.

Locate the gauge port in a 45° angle from a vertical up position so as to be accessible for gauge connections.

Use a wrench on the hex nut of the female fitting backing up the fitting with another wrench to keep tube from turning. Tighten the fittings together until they bottom out then tighten for an additional 1/4 turn so that coupling will seat properly.

Check the gauge port cap to make sure it is tight. If loose, tighten, being careful not to tighten too much as it will damage the valve in the gauge port.

Leak test all connections using an Electronic Leak Detector or a Halide Torch.

When tubing is installed in attics or drop ceiling, insulate the quick connect fitting on the larger tube thoroughly with 3/8" wall thickness, closed cell sponge tube insulation or equivalent. Failure to insulate will result in water damage to ceiling since the fitting will "sweat" and drop water on the ceiling.

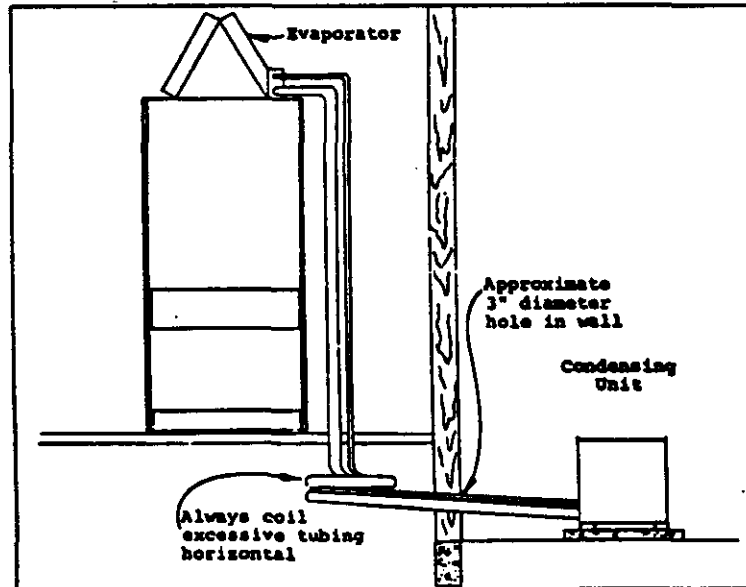

TABLE 3

| CHARGED TUBING (For use with "Q" versions) | | | | | |
|---|------------------------|------------------------|------------------------|------------------------|------------------------|
| MODEL NO. | Stub Tube* | 15' | 25' | 35' | 45' |
| 24UACQ 30UACQ 36UACQ | CTO* 3/8" & 3/4" | CT15A 3/8" & 5/8" | CT25A 3/8" & 3/4" | CT35 3/8" & 3/4" | CT45 3/8" & 3/4" |
| 42UACQ 48UACQ 60UACQ | CTO-12* 3/8" & 7/8" | CT15-12 3/8" & 7/8" | CT25-12 3/8" & 7/8" | CT35-12 3/8" & 7/8" | CT45-12 3/8" & 7/8" |
| *1/2 Stub Kit available, Order CTO-A or CTO-12A (For matching quick connect coils with sweat type outdoor units.) | | | | | |

SYSTEM START-UP

The outdoor section of the air conditioner units are shipped with a factory R-22 charge sufficient for the nominal (size for size) matching "A" coil when used with 25' of inter-connecting tubing. The "Q" models utilize "quick connect" refrigerant connectors and the "S" models use base valves. The units are shipped with the base valves in the closed position to contain the refrigerant charge within the unit.

- For "S" models, connect a vacuum pump to both base valve service ports.
- Evacuate the tubing and evaporator to 500 microns or less for a minimum of 30 minutes. Close the valve to the pump and wait for 15 minutes. The vacuum should not rise above 800 microns. If it rises above 800 or if you are not able to obtain 500 micron vacuum, pressurize with R-22, leak check, repair any leaks and repeat step 2.
- Close valve to the vacuum pump and disconnect. Break the vacuum by opening both the suction and liquid line base valves to the fully open position and connect service gauges for pressure check.
- Close disconnect switch and set the thermostat to cool and the temperature to the highest setting.
- Check for proper operation of the indoor fan and outdoor unit.
- Check and adjust charge if necessary. Refer to charge checking section.

| SATURATED SUCTION TEMPERATURE (R-22) | |
|--------------------------------------|------------------------------------|
| Suction Pressure PSIG | Saturated Suction Temperature (°F) |
| 50 | 26 |
| 53 | 28 |
| 55 | 30 |
| 58 | 32 |
| 61 | 34 |
| 63 | 36 |
| 65 | 38 |
| 67 | 39 |
| 70 | 41 |
| 73 | 43 |
| 76 | 45 |
| 79 | 47 |
| 82 | 49 |
| 86 | 51 |

TABLE 4

REFRIGERANT CHARGE CHECKING

- After connecting the service gauges and allowing the unit to run for at least 10 minutes until pressures are stable, record the suction and discharge (liquid) pressure.
- Install a thermometer on the suction line approximately 6" to 10" from the compressor on all models except the 60UAC models. On the 60UAC install the thermometer approximately 6" ahead of the suction line accumulator (between the accumulator and the indoor section).

3. Determine Superheat.

Refer to table 4 to determine the saturated suction temperature.

Suction line temperature (from step 2) _____
 Minus saturated suction temperature - _____
 Equals - Superheat _____

- Measure outdoor temperature and return air dry bulb and wet bulb temperature and refer to table 5 to determine the proper superheat setting.
- Adjust the charge to the proper superheat by adding charge to lower and removing charge to raise the superheat.
- Check final system operating pressures by comparing to the pressure curves later in this manual.

| SYSTEM SUPERHEAT | | | | |
|---|--------------------------------------|----|-----|----|
| Outdoor Ambient Temperature (°F Dry Bulb) | Return Air Temperature °F - Wet Bulb | | | |
| | 59 | 63 | 67 | 71 |
| 105 | 1 | 1 | 5 | |
| 95 | 1 | 3 | [8] | 20 |
| 90 | 1 | 7 | 14 | 26 |
| 85 | 3 | 9 | 19 | 33 |
| 80 | 8 | 14 | 25 | 39 |
| 75 | 10 | 20 | 30 | 42 |

TABLE 5

| TOTAL SYSTEM OPERATING CHARGE (Includes charge for the basic outdoor unit, indoor coil and 25' of inter-connecting tubing) | | |
|--|----------------|------------------------|
| Outdoor Section | Indoor Section | Total R-22 Charge (oz) |
| 24UAC*A | A 18A *-A | 78 |
| | A 30A *-A | 81 |
| | B 24EHQ1 | 110 |
| 30UAC*A | A 30A *-A | 88 |
| | B 36EHQ1 | 85 |
| 36UAC*A 36UACSA-B | A 30A *-A | 86 |
| | A 36A *-A | 96 |
| | A 42A *-A | 99 |
| | A 48A *-A | 110 |
| | B 36EHQ1 | 92 |
| | 3HCQ1 | 89 |
| 4HCQ | 106 | |
| 42UAC*A 42UACSA-B | A 42A *-A | 120 |
| | A 48A *-A | 132 |
| | BC 48A | 139 |
| | BC 60A | 146 |
| 48UAC*A 48UACSA-B | A 42A *-A | 153 |
| | A 48A *-A | 184 |
| | BC 48A | 174 |
| | BC 60A | 182 |
| | 4HCQ | 205 |
| 5HCQ | 155 | |
| 60UAC*A | A 48A *-A | 208 |
| | A 60A *-A | 225 |
| | BC 48A | 287 |
| | BC 60A | 292 |
| | 5HCQ | 264 |
| 60UACSA-B | A 48A *-A | 185 |
| | A 60A *-A | 202 |
| | BC 48A | 264 |
| | BC 60A | 269 |
| | 5HCQ | 241 |

The above includes 25' of 3/8" diameter liquid line. For other than 25' and other tube sizes, adjust the total charge according to the following schedule.

| <u>Liquid Line Diameter</u> | <u>OZ, R-22 Per Ft.</u> |
|-----------------------------|-------------------------|
| 1/4" | .25 |
| 3/8" | .6 |
| 1/2" | 1.2 |

INSTALLER NOTE: Stamp or mark the final system charge determined above on the outdoor unit serial plate.

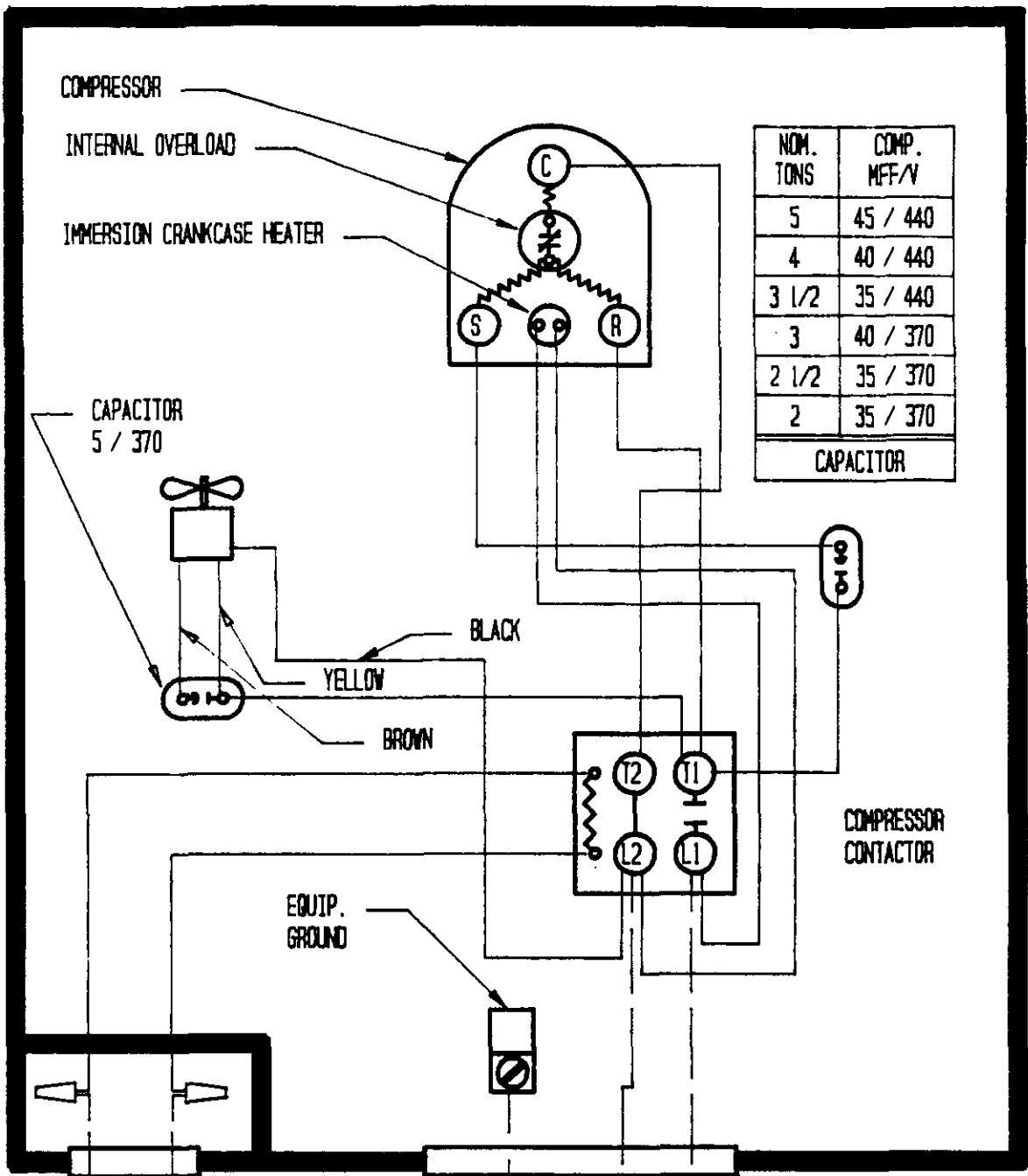

4080-1108

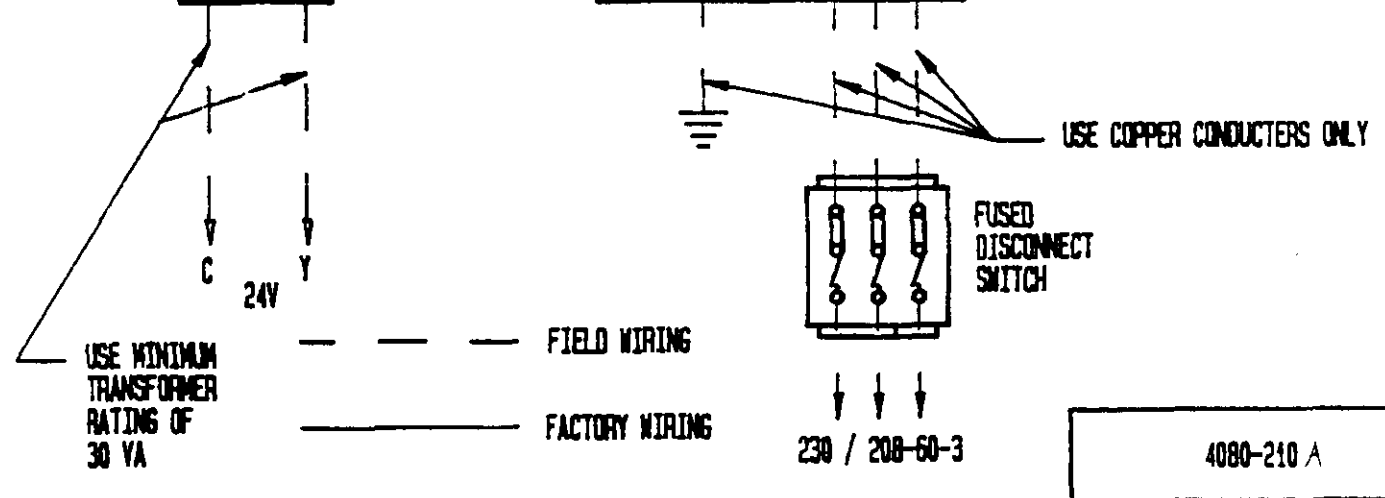
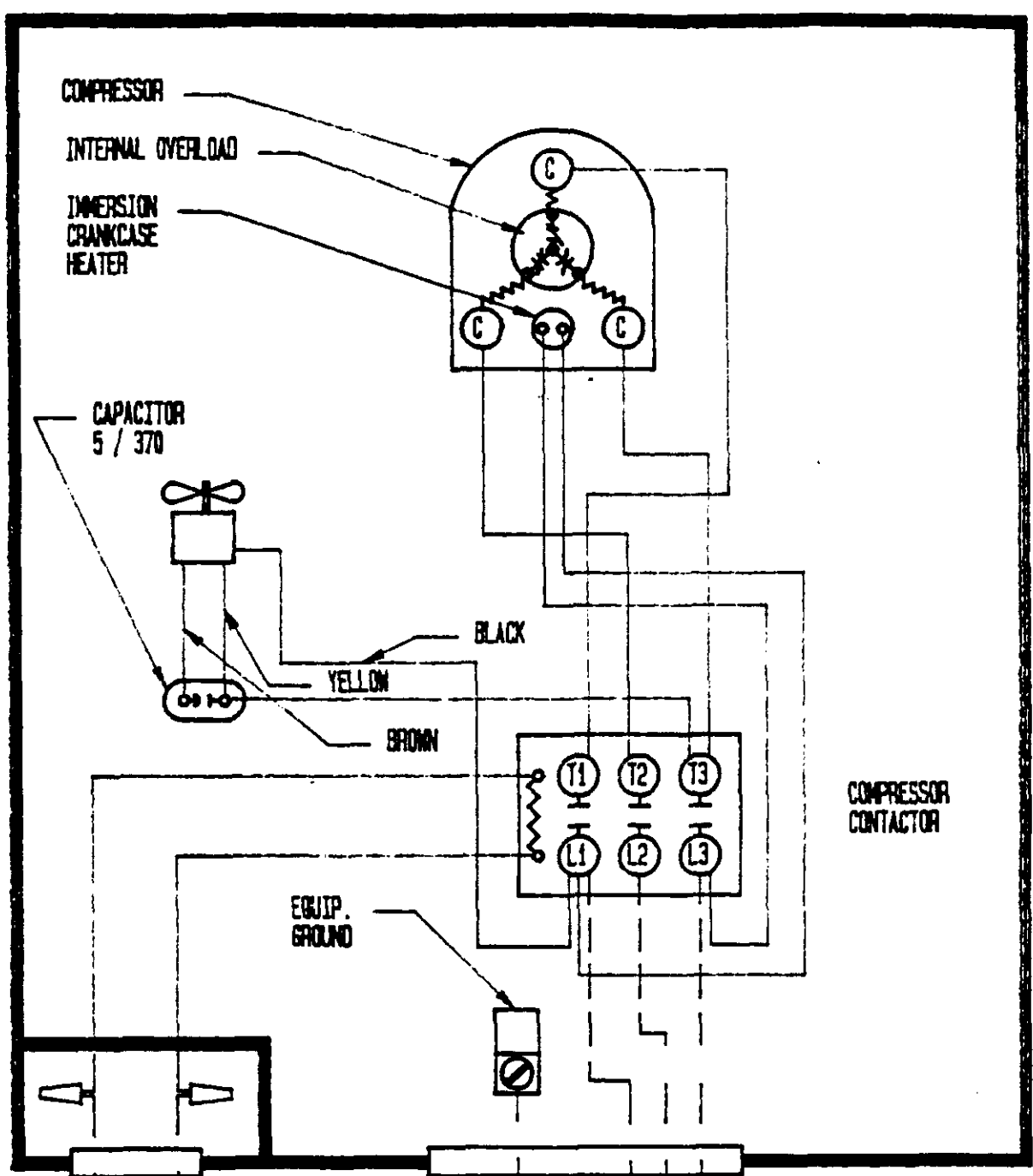

USE MINIMUM
TRANSFORMER
RATING OF
30 VA

FIELD WIRING

FACTORY WIRING

USE COPPER CONDUCTORS ONLY

FUSED
DISCONNECT
SWITCH

230 / 208-60-3

4080-210 A

TYPICAL APPLICATION — OIL FURNACE

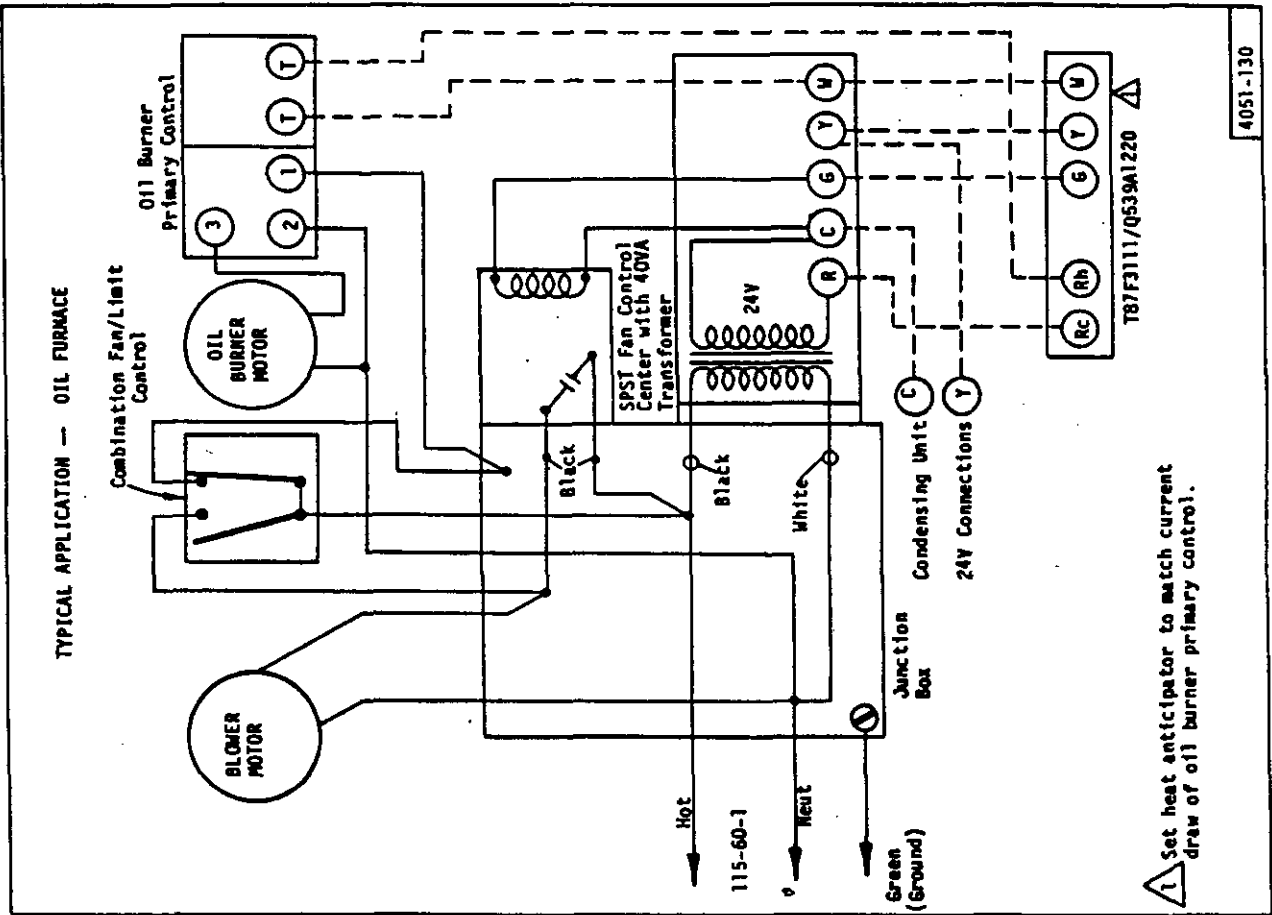

⚠ Set heat anticipator to match current draw of oil burner primary control.

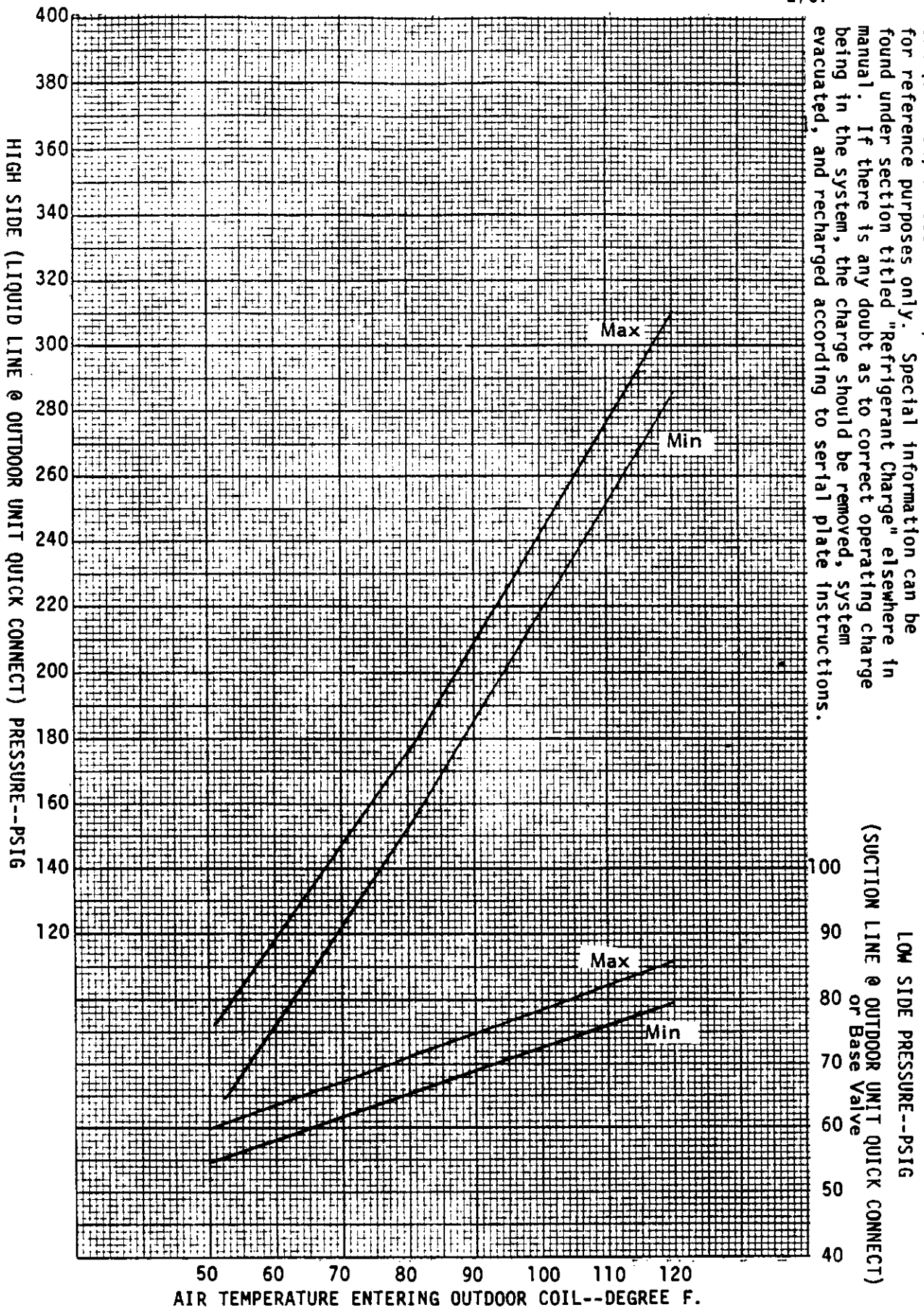

TI Curves are based upon 80°DB, 67°WB R.A. Temp. and h. CFM (airflow) across the evaporator coil and should be used for reference purposes only. Special information can be found under section titled "Refrigerant Charge" elsewhere in manual. If there is any doubt as to correct operating charge being in the system, the charge should be removed, system evacuated, and recharged according to serial plate instructions.

*Quick Connect or Sweat Fittings

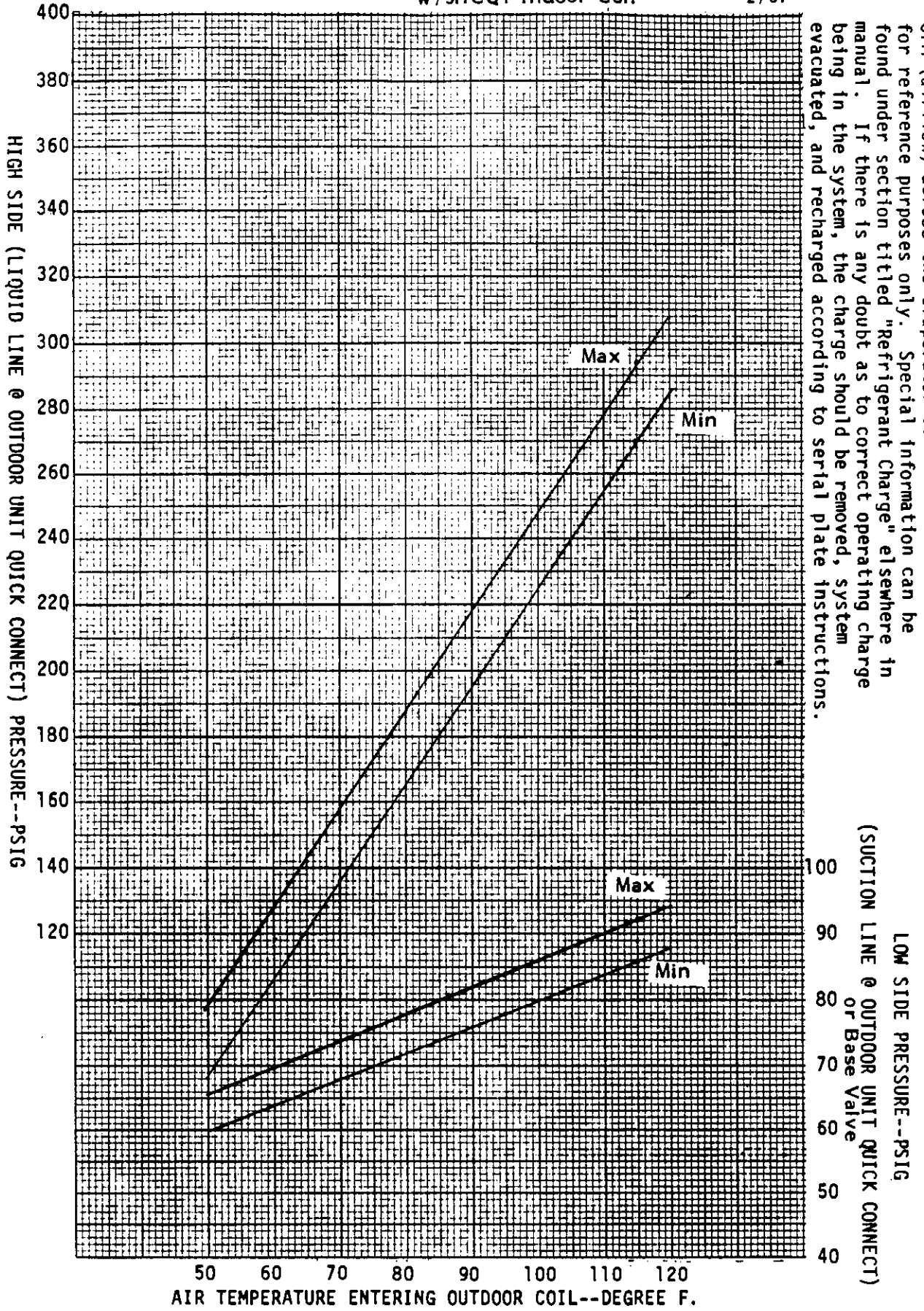

These curves are based upon 80°DB, 67°WB R.A. Temp. and Rated CFM (airflow) across the evaporator coil and should be used for reference purposes only. Special information can be found under section titled "Refrigerant Charge" elsewhere in manual. If there is any doubt as to correct operating charge being in the system, the charge should be removed, system evacuated, and recharged according to serial plate instructions.

The curves are based upon 80°DB, 67°WB R.A. Temp. and based CFM (airflow) across the evaporator coil and should be used for reference purposes only. Special information can be found under section titled "Refrigerant Charge" elsewhere in manual. If there is any doubt as to correct operating charge being in the system, the charge should be removed, system evacuated, and recharged according to serial plate instructions.

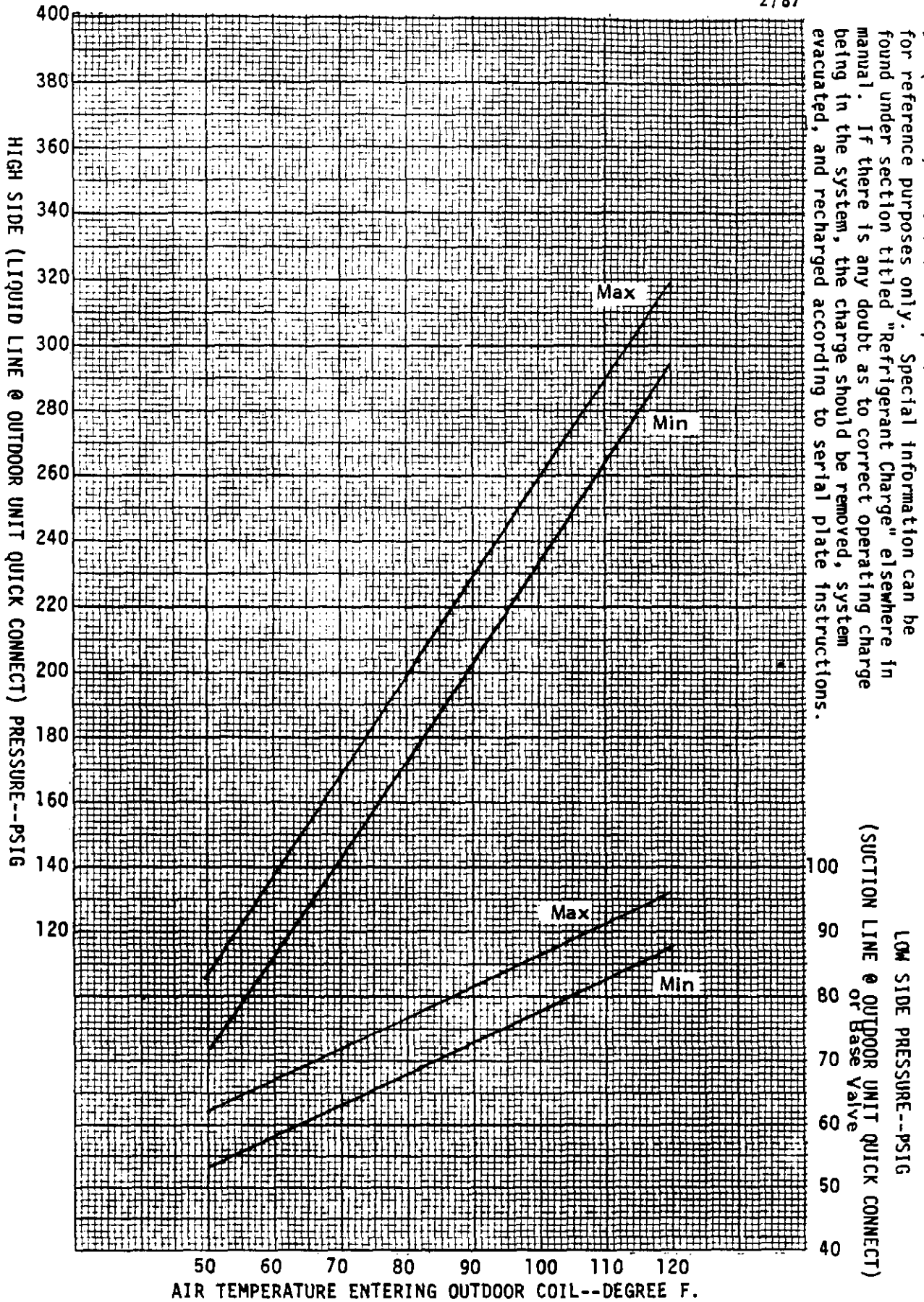

*Quick Connect or Sweat Fittings

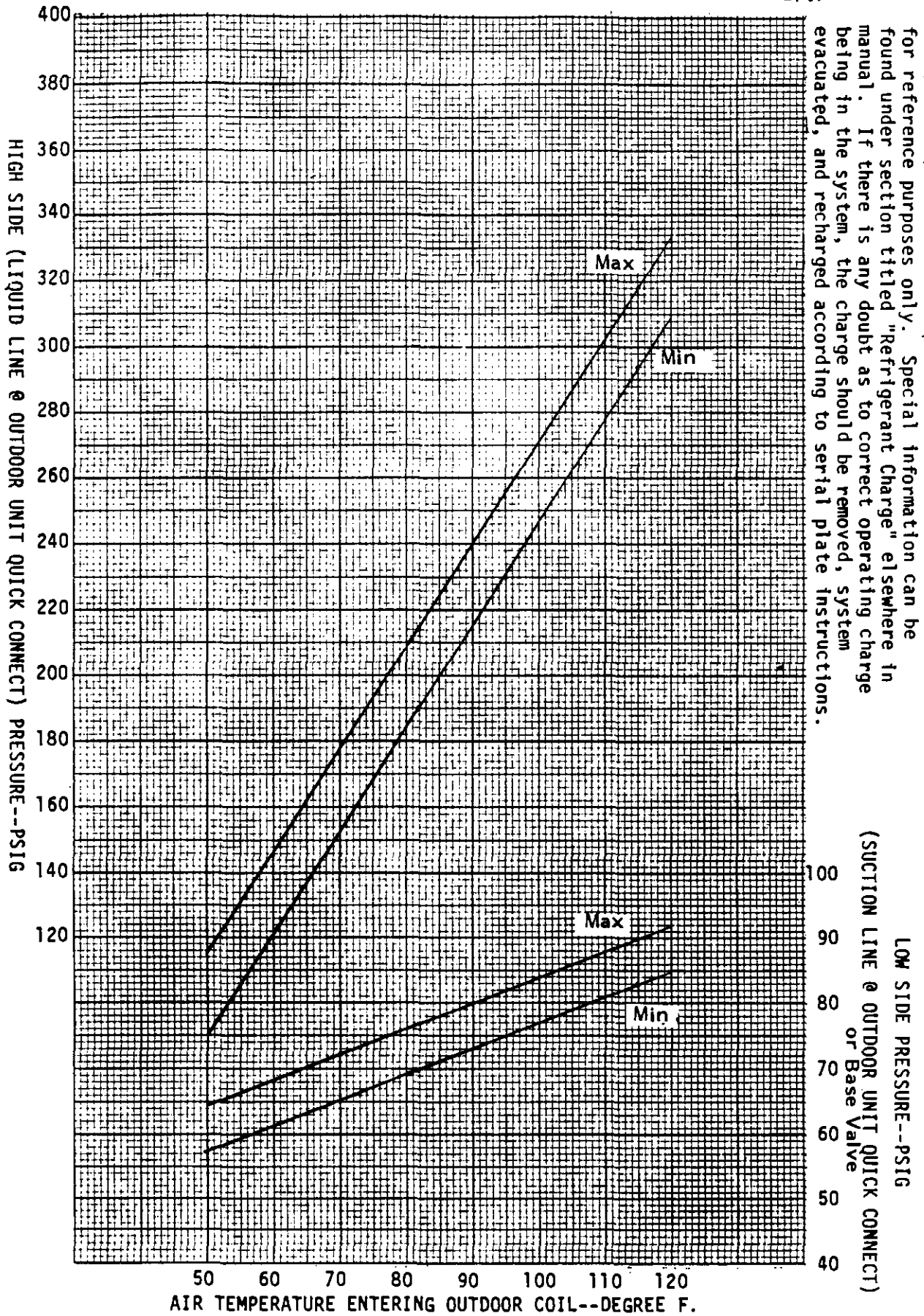

These curves are based upon 80°DB, 67°WB R.A. Temp. and Rated CFM (airflow) across the evaporator coil and should be used for reference purposes only. Special information can be found under section titled "Refrigerant Charge" elsewhere in manual. If there is any doubt as to correct operating charge being in the system, the charge should be removed, system evacuated, and recharged according to serial plate instructions.

*Quick Connect or Sweat Fittings

Models 36UAC*A and 36UAC*A-B
w/A30A*-A, A36A*-A and B36EHQ1 Indoor Coil

2/87

The curves are based upon 80°DB, 67°WB R.A. Temp. and R. A. CFM (airflow) across the evaporator coil and should be used for reference purposes only. Special information can be found under section titled "Refrigerant Charge" elsewhere in manual. If there is any doubt as to correct operating charge being in the system, the charge should be removed, system evacuated, and recharged according to serial plate instructions.

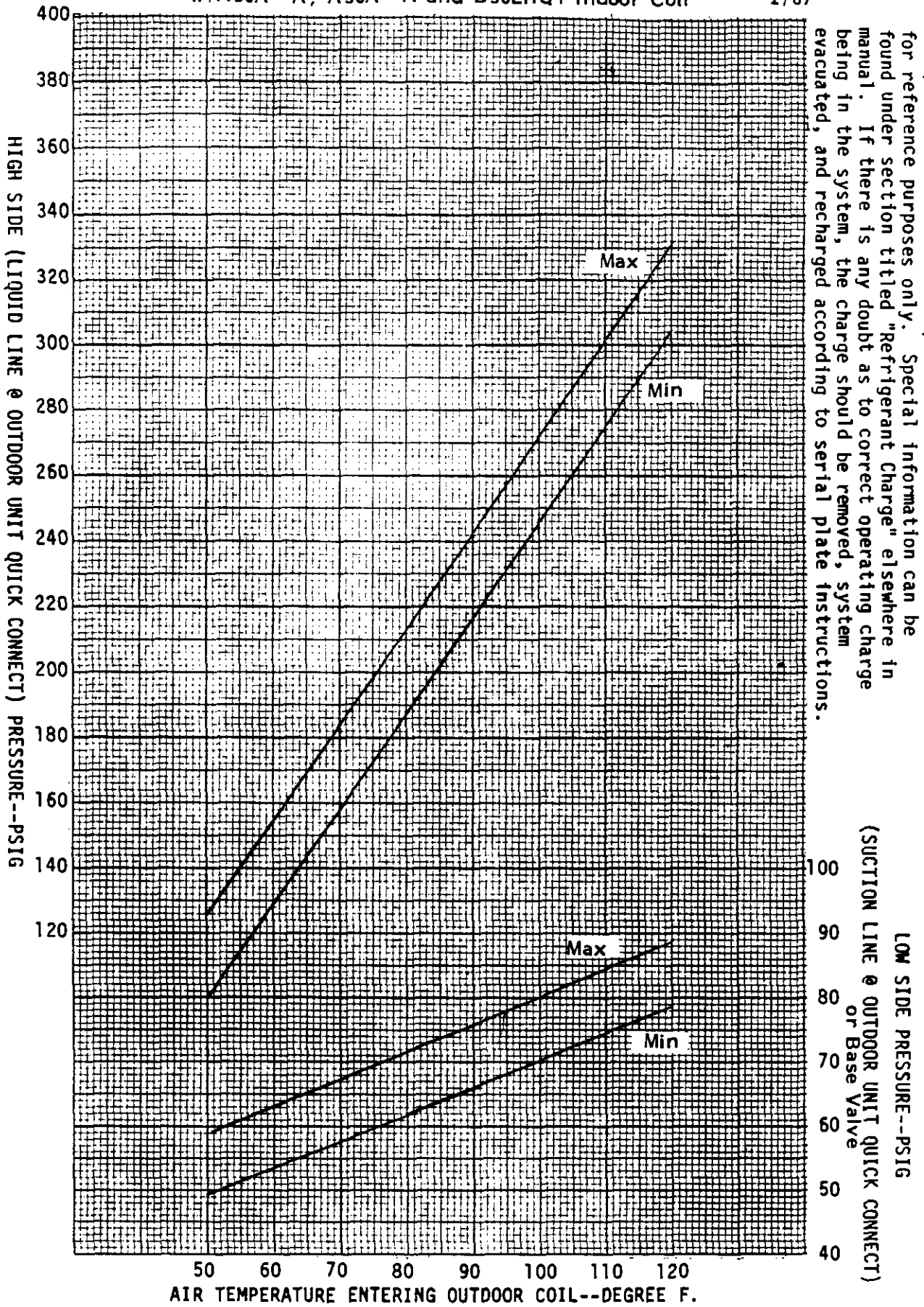

*Quick Connect or Sweat Fittings

Model 30UAC*A w/3HCQ1 Indoor Coil

2/87

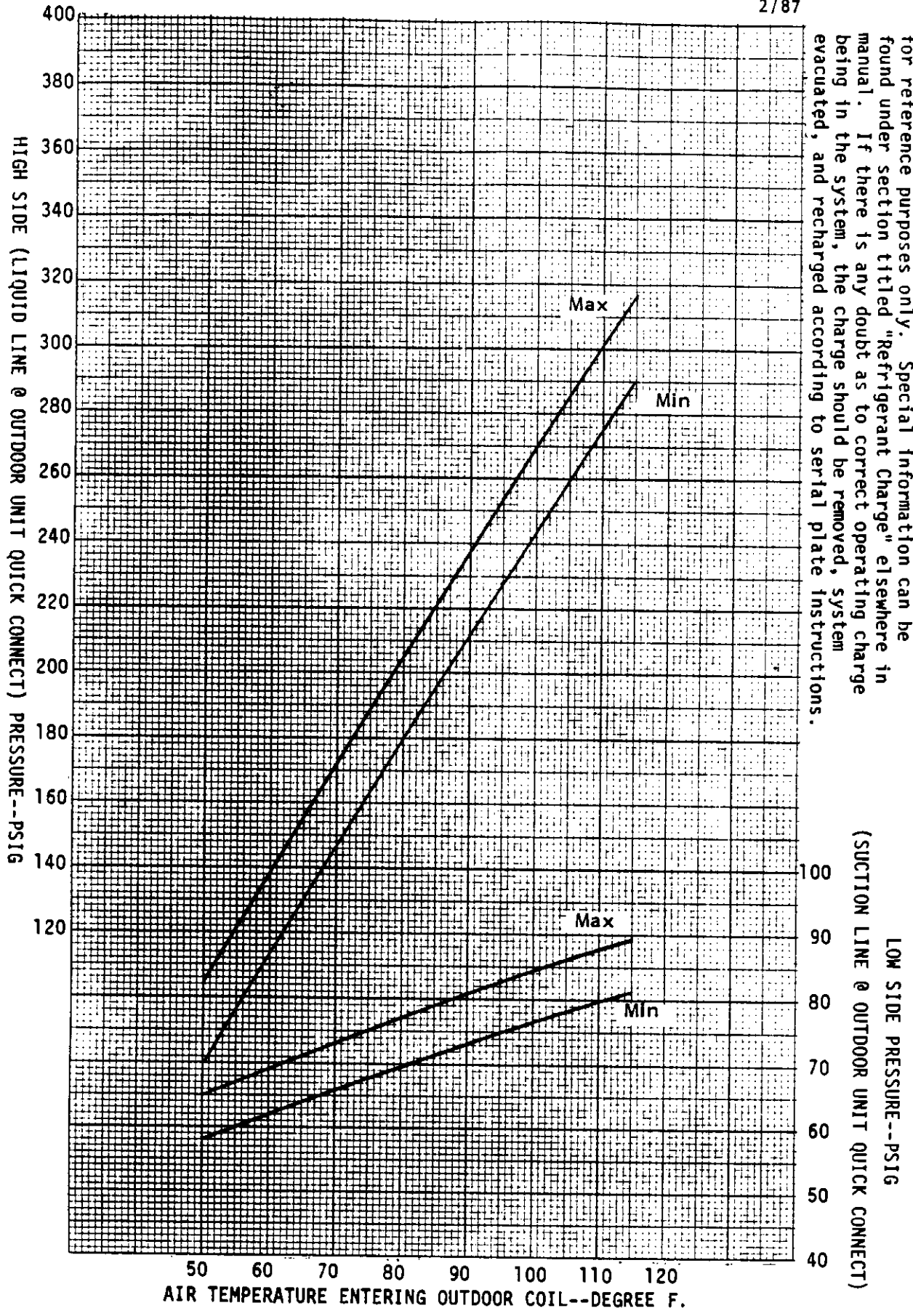

These curves are based upon 80°DB, 67°WB R.A. Temp. and Rated CFM (airflow) across the evaporator coil and should be used for reference purposes only. Special information can be found under section titled "Refrigerant Charge" elsewhere in manual. If there is any doubt as to correct operating charge being in the system, the charge should be removed, system evacuated, and recharged according to serial plate instructions.

LOW SIDE PRESSURE--PSIG
(SUCTION LINE @ OUTDOOR UNIT QUICK CONNECT)

HIGH SIDE (LIQUID LINE @ OUTDOOR UNIT QUICK CONNECT) PRESSURE--PSIG

AIR TEMPERATURE ENTERING OUTDOOR COIL--DEGREE F.

Models 36UAC *A and 36UAC *A-B
w/A42A*-A and A48A*-A Indoor Coil

2/87

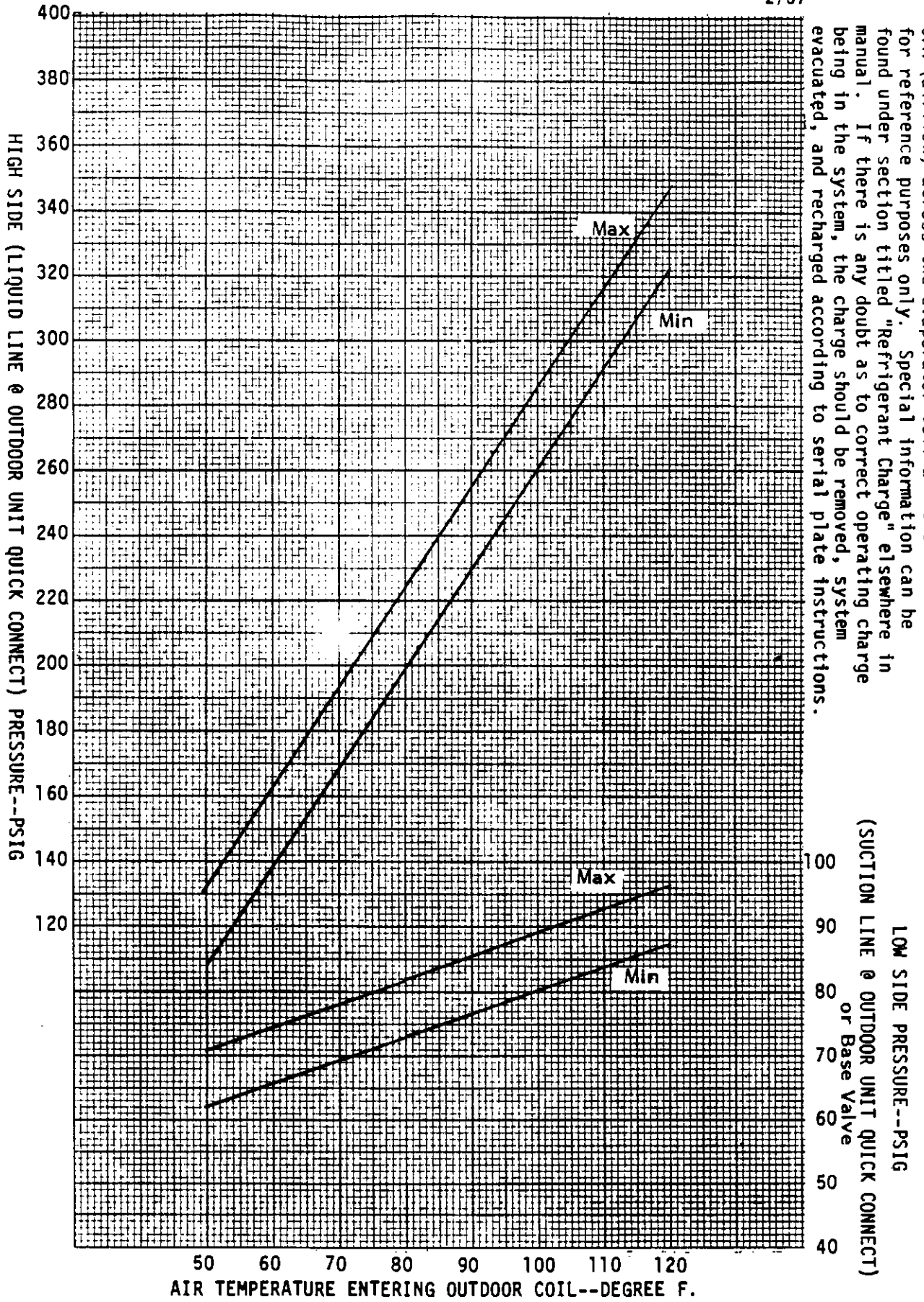

The curves are based upon 80°DB, 67°WB R.A. Temp. and R.A. CFM (airflow) across the evaporator coil and should be used for reference purposes only. Special information can be found under section titled "Refrigerant Charge" elsewhere in manual. If there is any doubt as to correct operating charge being in the system, the charge should be removed, system evacuated, and recharged according to serial plate instructions.

*Quick Connect or Sweat Fittings

Models 36UAC*A and 36UAC*A-B
 *RHCQ1 Indoor Coil

2/87

HIGH SIDE (DISCHARGE LINE) PRESSURE--PSIG

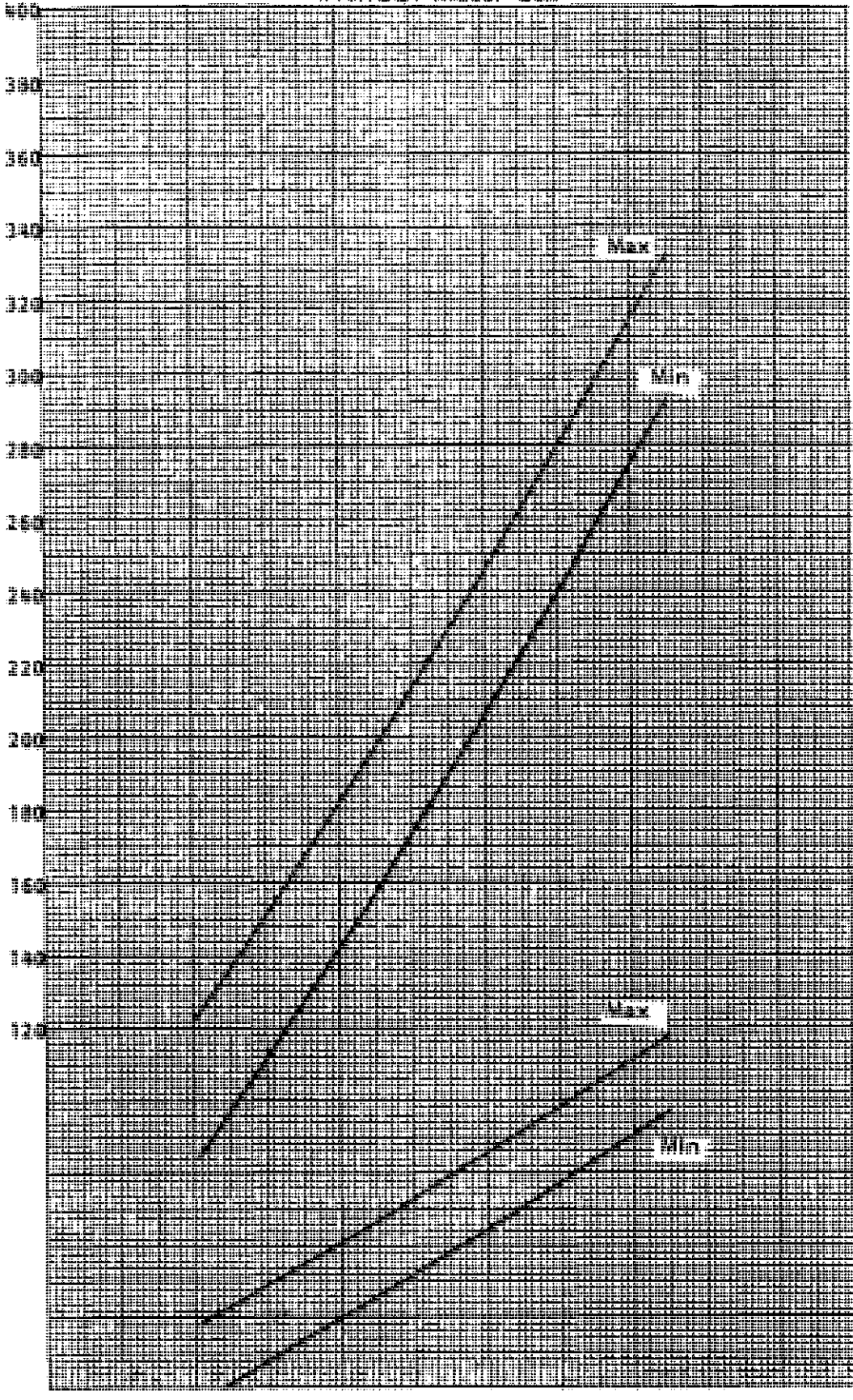

AIR TEMPERATURE ENTERING OUTDOOR COIL--DEGREE F.

These curves are based upon 80°DB, 67°WB R.A. Temp. and rated CFM (airflow) across the evaporator coil and should be used for reference purposes only. Special information can be found under section titled "Refrigerant Charge" elsewhere in manual. If there is any doubt as to correct operating charge being in the system, the charge should be removed, system evacuated, and recharged according to serial plate instructions.

LOW SIDE PRESSURE--PSIG
 (SUCTION LINE)

Models 36UAC*A and 36UAC*A-B
with Indoor Coil

2/87

HIGH SIDE (DISCHARGE LINE) PRESSURE--PSIG

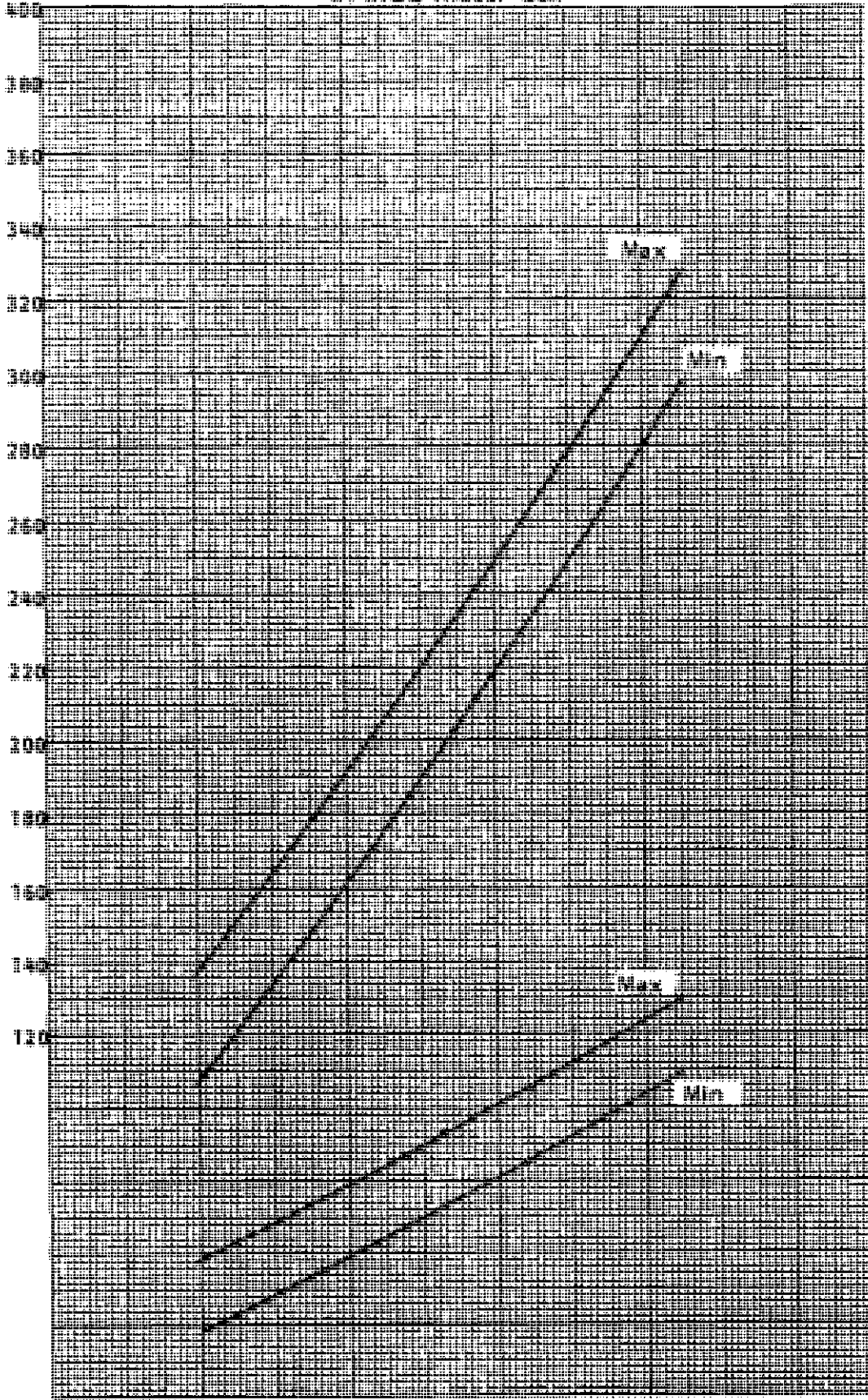

AIR TEMPERATURE ENTERING OUTDOOR COIL--DEGREE F.

Use curves are based upon 80°DB, 67°WB R.A. Temp. and rated (air-flow) across the evaporator coil and should be used for reference purposes only. Special information can be found under section titled "Refrigerant Charge" elsewhere in manual. If there is any doubt as to correct operating charge being in the system, the charge should be removed, system evacuated, and recharged according to serial plate instructions.

LOW SIDE PRESSURE--PSIG
(SUCTION LINE)

MODEL 42UAC*A , 42UAC *A-B
 With A42A*-A, A48A*-A, BC48A INDOOR COIL

2/87

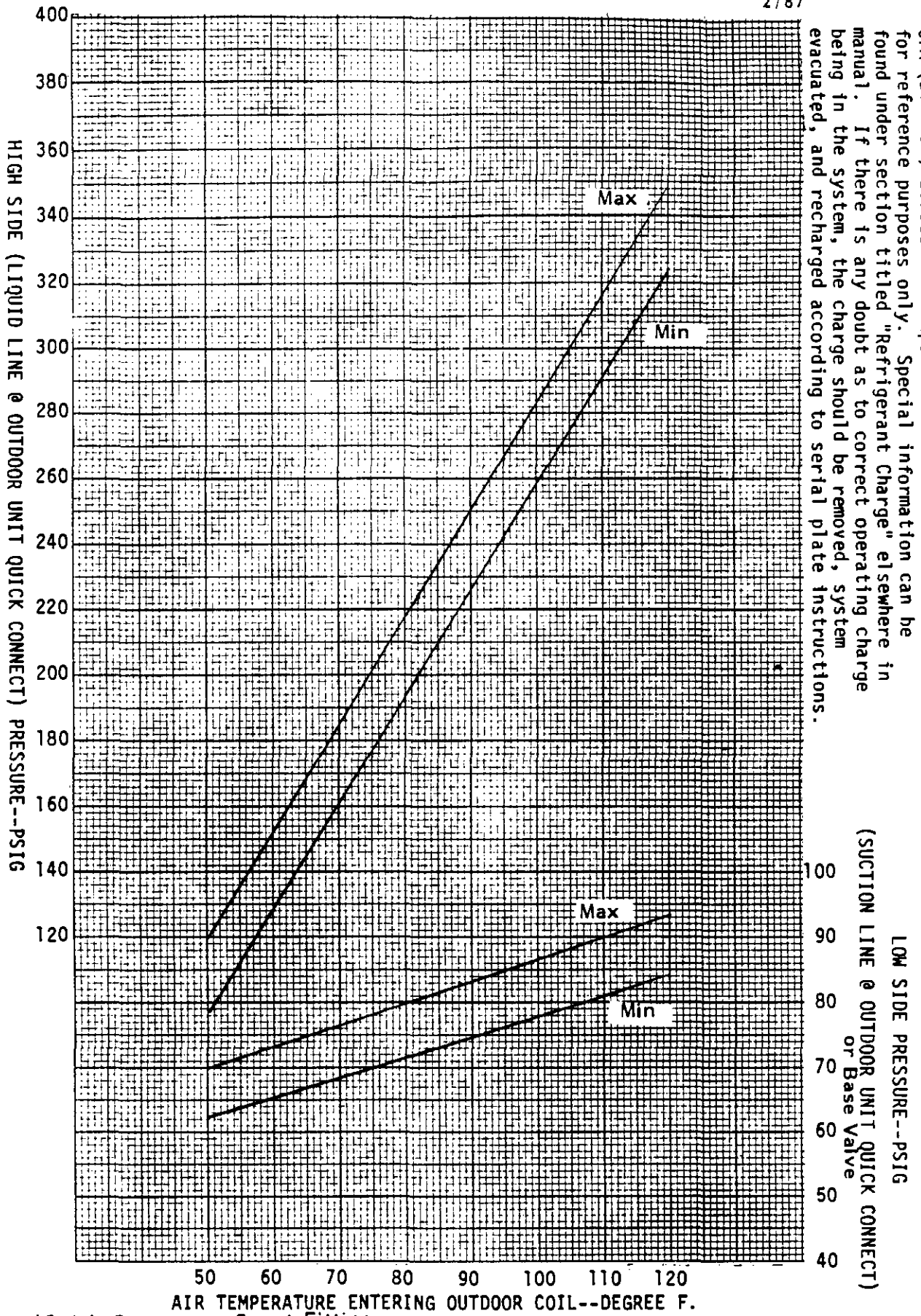

These curves are based upon 80°DB, 67°WB R.A. Temp. and Rated CFM (air-flow) across the evaporator coil and should be used for reference purposes only. Special information can be found under section titled "Refrigerant Charge" elsewhere in manual. If there is any doubt as to correct operating charge being in the system, the charge should be removed, system evacuated, and recharged according to serial plate instructions.

*Quick Connect or Sweat Fittings

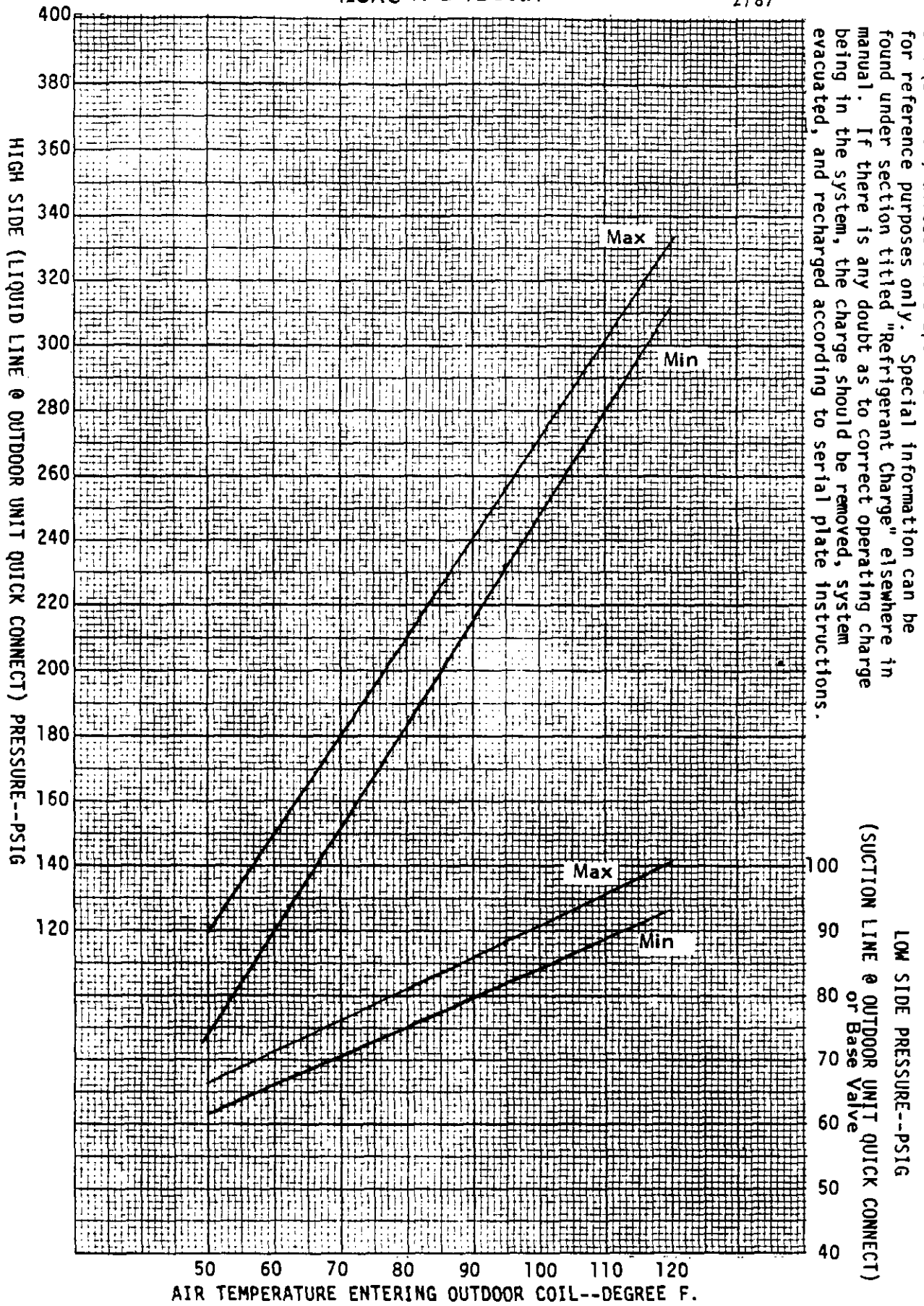

*Quick Connect or Sweat Fittings

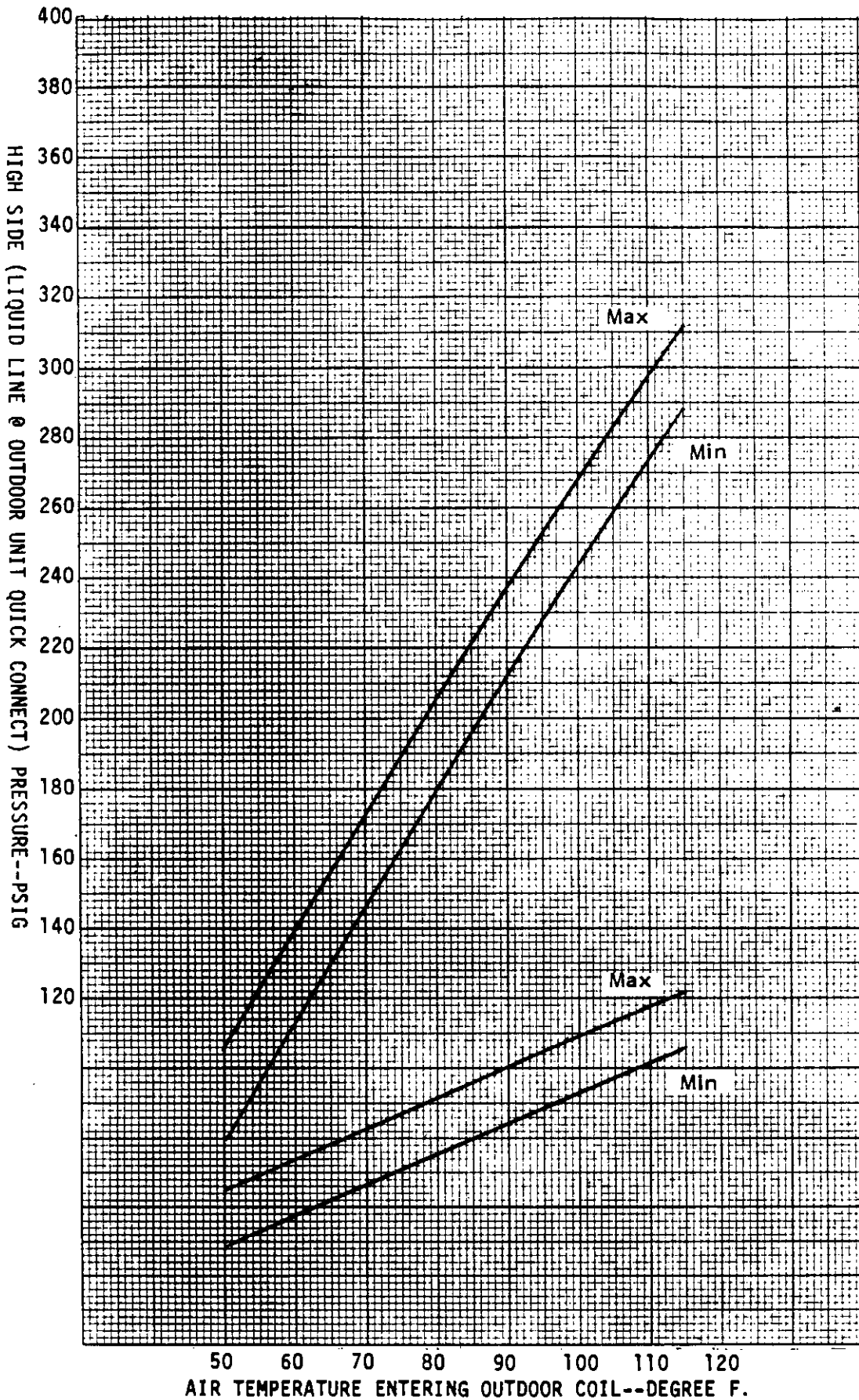

These curves are based upon 80°DB, 67°WB R.A. Temp. and Rated CFM (airflow) across the evaporator coil and should be used for reference purposes only. Special information can be found under section titled "Refrigerant Charge" elsewhere in manual. If there is any doubt as to correct operating charge being in the system, the charge should be removed, system evacuated, and recharged according to serial plate instructions.

LOW SIDE PRESSURE--PSIG
(SUCTION LINE @ OUTDOOR UNIT QUICK CONNECT)

Models 48UAC*A and 48UAC*A-B
w/A48A*-A, BC48A, BC60A Indoor Coils

2/87

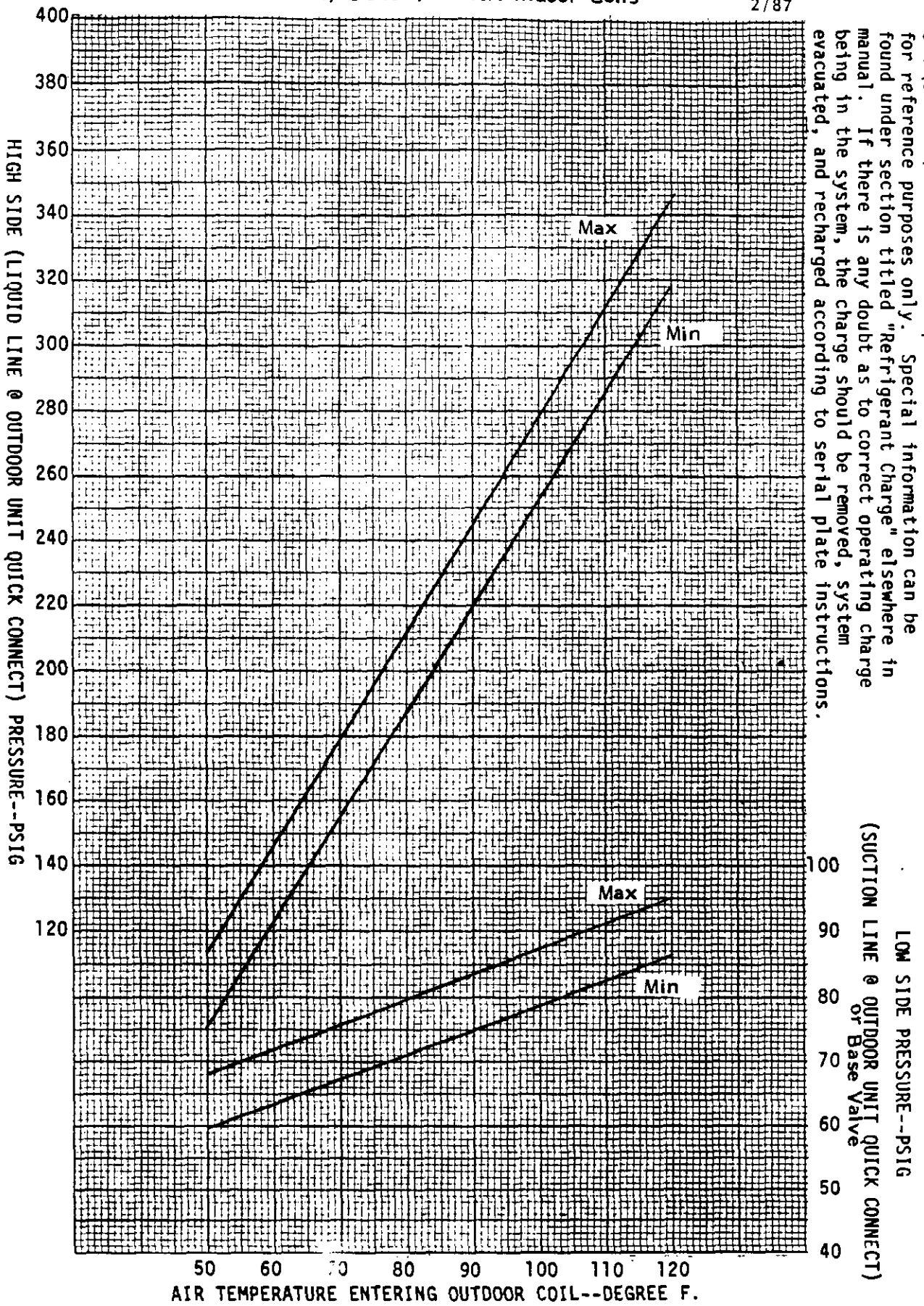

The curves are based upon 80°F DB, 67°F WB R.A. Temp. and Rated CFM (airflow) across the evaporator coil and should be used for reference purposes only. Special information can be found under section titled "Refrigerant Charge" elsewhere in manual. If there is any doubt as to correct operating charge being in the system, the charge should be removed, system evacuated, and recharged according to serial plate instructions.

*Quick Connect or Sweat Fittings

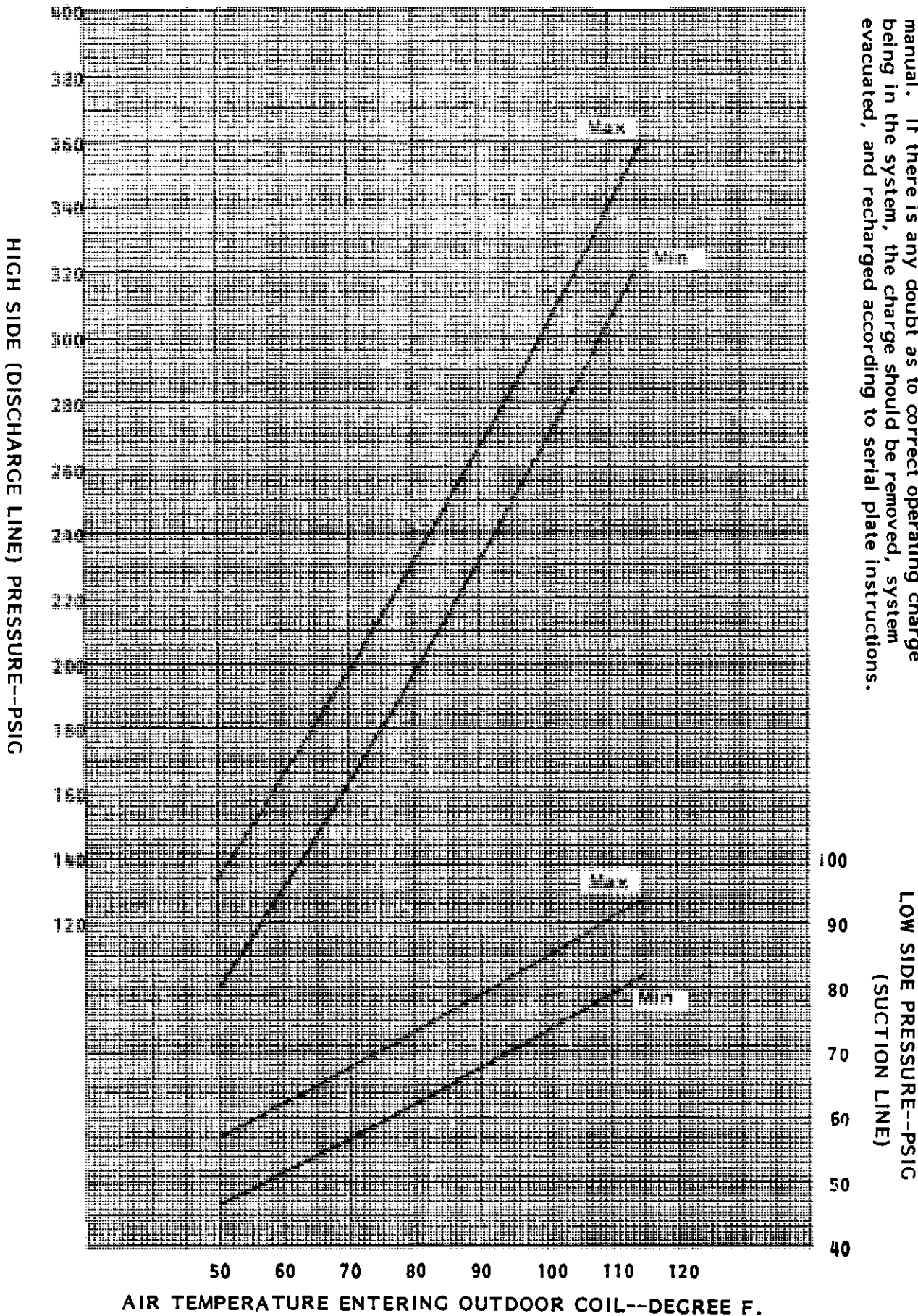

These curves are based upon 80°DB, 67°WB R.A. Temp. and rated CFM (airflow) across the evaporator coil and should be used for reference purposes only. Special information can be found under section titled "Refrigerant Charge" elsewhere in manual. If there is any doubt as to correct operating charge being in the system, the charge should be removed, system evacuated, and recharged according to serial plate instructions.

Models 48UAC*A and 48UAC*A-B
w/A42A*-A, 5HCQ Indoor Coil

2/87

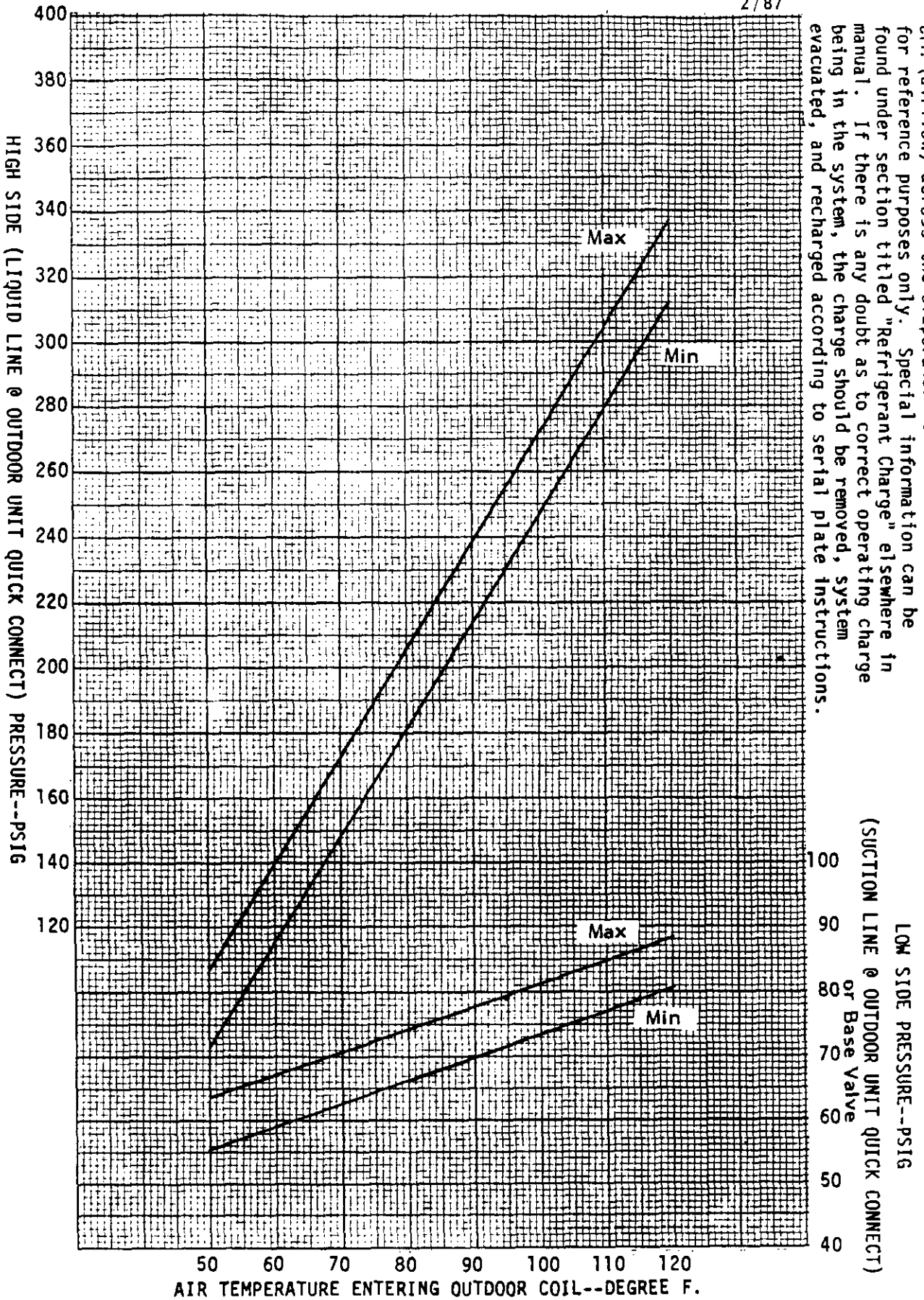

Curves are based upon 80°DB, 67°WB R.A. Temp. and CFM (airflow) across the evaporator coil and should be used for reference purposes only. Special information can be found under section titled "Refrigerant Charge" elsewhere in manual. If there is any doubt as to correct operating charge being in the system, the charge should be removed, system evacuated, and recharged according to serial plate instructions.

*Quick Connect or Sweat Fittings

Models 60UAC*A and 60UAC*A-B
w/5HCQ Indoor Coil

2/87

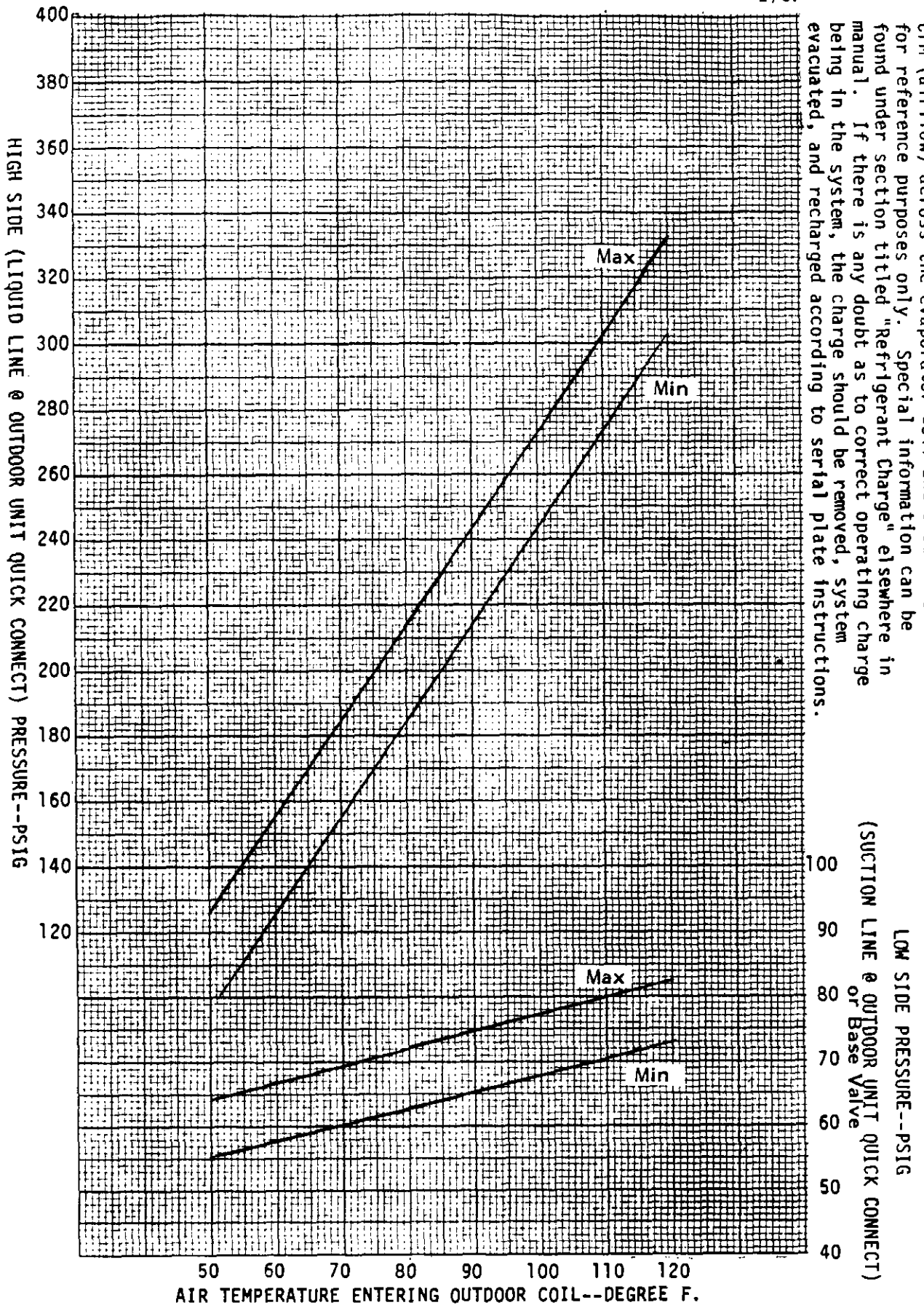

These curves are based upon 80°DB, 67°WB R.A. Temp. and Rated CFM (airflow) across the evaporator coil and should be used for reference purposes only. Special information can be found under section titled "Refrigerant Charge" elsewhere in manual. If there is any doubt as to correct operating charge being in the system, the charge should be removed, system evacuated, and recharged according to serial plate instructions.

*Quick Connect or Sweat Fittings

Models 60UAC *A and 60UAC*A-B
w/A48A*-A and A60A*-A Indoor Coil

2/87

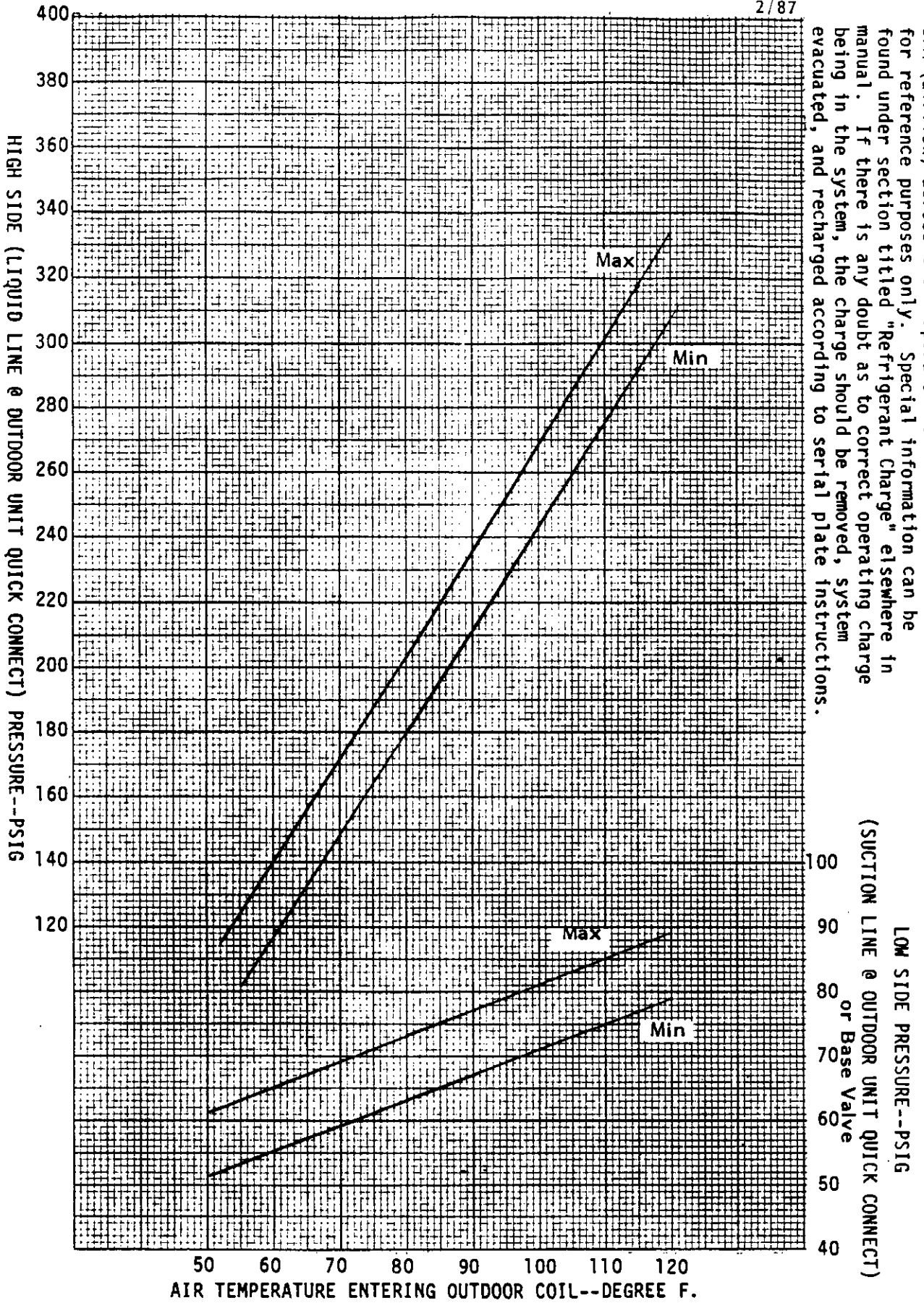

These curves are based upon 80°DB, 67°WB R.A. Temp. and 1.0 CFM (airflow) across the evaporator coil and should be used for reference purposes only. Special information can be found under section titled "Refrigerant Charge" elsewhere in manual. If there is any doubt as to correct operating charge being in the system, the charge should be removed, system evacuated, and recharged according to serial plate instructions.

*Quick Connect or Sweat Fittings

Models 60UAC*A and 60UAC*A-B
w/BC48A, BC60A Indoor Coil

2/87

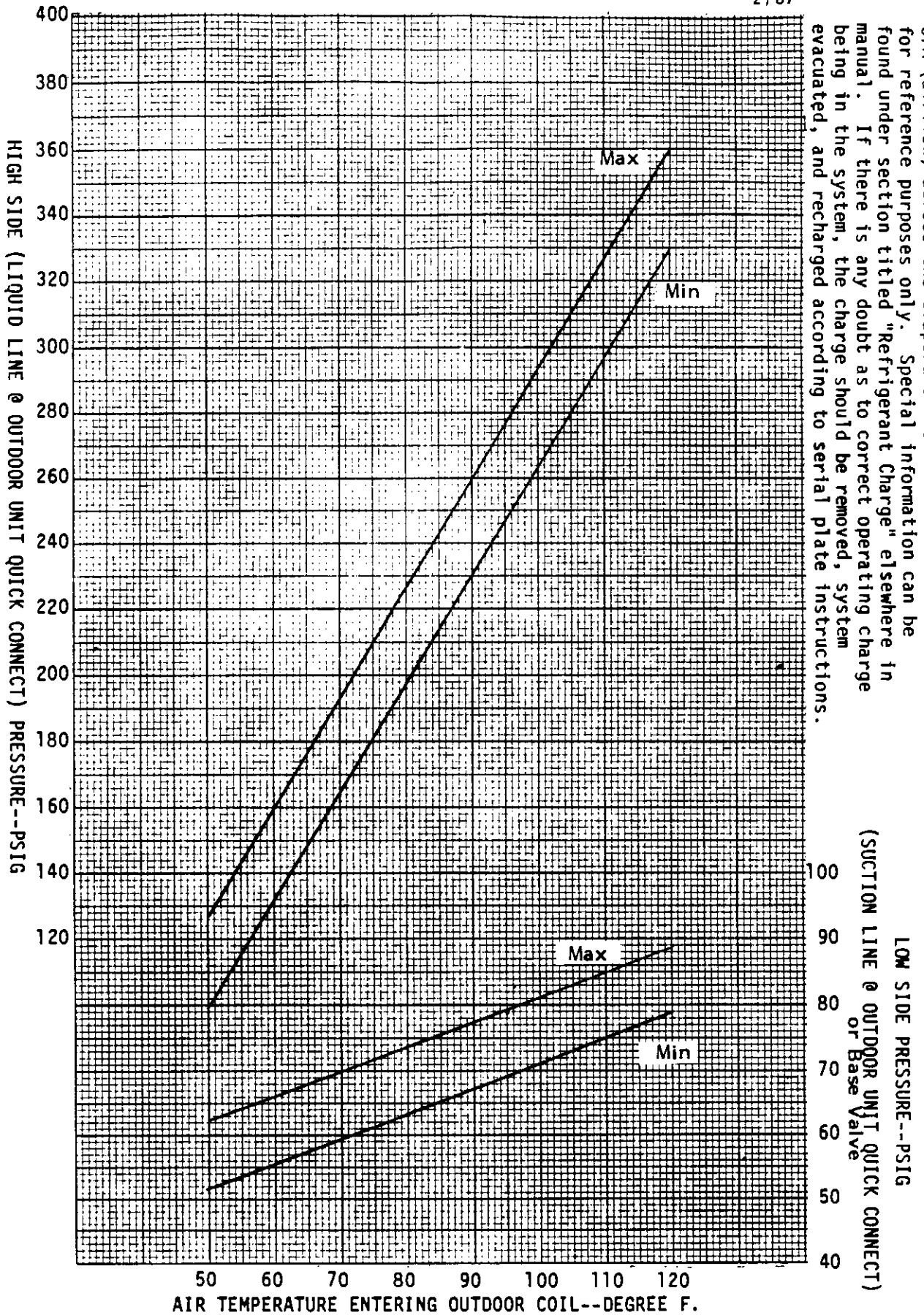

These curves are based upon 80°DB, 67°WB R.A. Temp. and Rated CFM (airflow) across the evaporator coil and should be used for reference purposes only. Special information can be found under section titled "Refrigerant Charge" elsewhere in manual. If there is any doubt as to correct operating charge being in the system, the charge should be removed, system evacuated, and recharged according to serial plate instructions.

*Quick Connect or Sweat Fittings

