

INSTALLATION INSTRUCTIONS

HIGH EFFICIENCY SPLIT SYSTEM AIR CONDITIONER AND HEAT PUMP COIL ONLY INDOOR SECTION

FOR USE WITH:

**OIL
GAS
FURNACES**

MANUAL 2100-118 REV. H
SUPERSEDES REV. G
FILE VOL. I, TAB 6

TABLE OF CONTENTS

I.	Application and Location	1
	General	1
	Application	3
	Expansion Device	4
	Caution When Using 5780 Series Couplings	5
	Airflow Pressure Drop Measurement	6
	CFM for Add-On Coils	6
	Condensate Drain Drop	8
II.	Wiring	9
	General Operation Heat Pump/Fossil Fuel Furnace	9
	Note On Indoor Blower Operation	9
	Control Circuit Wiring--AC/HP	9
	Wall Thermostats AC/HP	10
	Control Circuit Diagrams A/C	11
	Control Circuit Diagrams H/P	12

FIGURES AND TABLES

Figure 1	1
Figure 2	3
Figure 3	3
Figure 4	4
Figure 5	5
Figure 6	5
Figure 7	6
Figure 8	8

Table 1	1
Table 2	2
Table 3	7
Table 4	9
Table 5	10

APPLICATION AND LOCATION

GENERAL

The model A18AQ and S-A through A60AQ and S-A series indoor cooling coils are designed for use with outdoor section air conditioners and heat pumps. They are designed for use with gas or oil furnaces. Optional coil casing plenums are also available.

FIGURE 1
Nomenclature Explanation--Example:

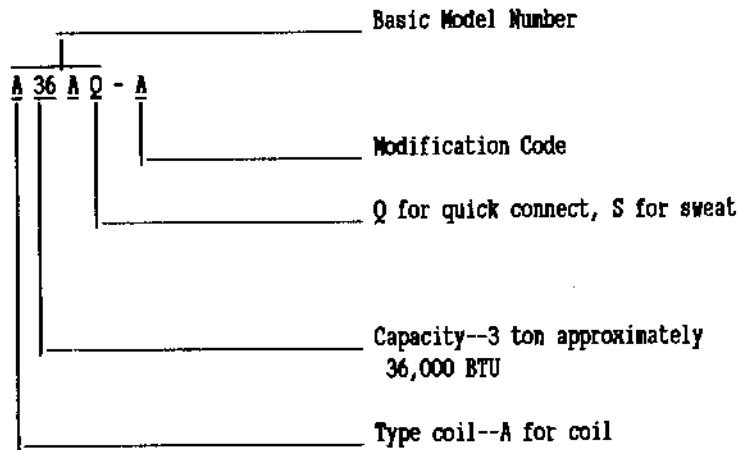

TABLE 1

COIL DIMENSIONS (Inches)				
"A" Coil	A	B	C	Drain Pan Opening (WGL)
A18A*	18	20-1/2	11-1/4	12-1/4 & 15-1/4
A30A*	18	20-1/2	14	12-1/4 & 15-1/4
A36A*	18	20-1/2	16	12-1/4 & 15-1/4
A42A*	22	20-1/2	18	14-3/4 & 15-1/4
A48A*	22	20-1/2	22	14-3/4 & 15-1/4
A60A*	25	20-1/2	24	16 x 15-1/4

TABLE 2

APPROVED MATCHED COMBINATIONS, RATED CFM STATIC PRESSURE DROP, ORIFICE PART NUMBER AND DIAMETER ①						
Condensing Unit Model Number	Evaporator Coil Model Number	CFM	Rated Airflow		Orifice Part No.	Orifice Diameter (In.)
			Pressure Drop "H ₂ O" ②	Recommended Air Flow Range		
24UACQB 24UACSB	A18AQ-A	750	.20	640 - 825	5625-059 (3)	.059
	A18AS-A					
	A30AQ-B	825	.15	700 - 910	5625-059 (3)	.059
	A30AQ-A	825	.15	700 - 910	5625-059 (4)	.059
	A30AS-A					
30UACQA 30UACSA	A30AQ-A	1000	.20	850 - 1100	5625-063 (3)	.063
	A30AS-A					
36UACQA 36UACSA 36UACSA-B	A30AQ-A	1125	.30	950 - 1240	5625-069 (4)	.069
	A30AS-A					
	A36AQ-B	1200	.30	1020 - 1320	5625-072 (3)	.072
	A36AQ-A	1200	.30	1020 - 1320	5625-069 (4)	.069
	A36AS-A					
	A42AQ-A	1380	.30	1170 - 1520	5625-069 (4)	.069
	A42AS-A					
	A48AQ-A	1450	.27	1230 - 1600	5625-069 (4)	.069
	A48AS-A					
	A42AQ-A	1325	.30	1125 - 1450	5625-078 (3)	.078
42UACQA 42UACSA	A42AS-A					
	A48AQ-A	1525	.30	1300 - 1675	5625-078 (4)	.078
42UACSA-B	A48AS-A					
	A42AQ-A	1325	.30	1125 - 1450	5625-081 (4)	.081
48UACQA 48UACSA	A42AS-A					
	A48AQ-A	1525	.30	1300 - 1675	5625-081 (3)	.081
48UACSA-B	A48AS-A					
	A48AS-A	1500	.30	1275 - 1650	5625-092 (4)	.092
60UACQA 60UACSA	A48AS-A					
	A48AS-A	1500	.30	1275 - 1650	5625-092 (4)	.092
60UACSA-B	A60AQ-A	1900	.30	1615 - 2100	5625-092 (3)	.092
	A60AS-A					
18HPQ6	A30AQ-A	650	.10	550 - 700	5625-061 (5)	.061
24HPQ6	A30AQ-A	750	.15	650 - 825	5625-063 (3)	.063
36HPQ7	A36AQ-A	1200	.30	1020 - 1320	5625-067 (3)	.067
30HPQ6	A36AQ-A	1130	.26	950 - 1240	5625-067 (3)	.067
37BCS1	A36AS-A	1200	.30	1020 - 1320	5625-069 (5)	.069
42BCS1	A42AS-A	1450	.30	1230 - 1600	5625-078 (3)	.078
	A48AS-A	1450	.25	1230 - 1600	5625-078 (5)	.078
48BCS2	A48AS-A	1500	.25	1275 - 1650	5625-081 (3)	.081
60BCS1	A60AS-A	1900	.30	1615 - 2100	5625-092 (3)	.092
24UHPOA	A30AQ-A	800	.16	700 - 910	5625-059 (4)	.059
24UHPOA	A30AQ-B	800	.16	700 - 910	5625-059 (3)	.059
30UHPOA	A36AQ-A	1050	.20	900 - 1150	5625-067 (4)	.067
30UHPOA	A42AS-A	1050	.15	900 - 1150	5625-067 (4)	.067
36UHPOA	A36AQ-A	1200	.30	1020 - 1320	5625-072 (4)	.072
36UHPOA	A36AQ-B	1200	.30	1020 - 1320	5625-072 (3)	.072
36UHPOA	A42AS-A	1200	.20	1020 - 1320	5625-072 (4)	.072

IMPORTANT INSTALLER NOTE:

- (1) All coils are suitable for up or down airflow direction.
- (2) Measured across the evaporator coil assembly, including drain pan.
- (3) This orifice is shipped installed in the coil. When this combination of condensing unit and indoor coil is used, the orifice is properly sized.
- (4) Proper diameter orifice is NOT installed in the indoor coil. Proper orifice diameter is shipped with the outdoor unit packaged with its installation instructions. The orifice MUST be replaced with the proper orifice shown.
- (5) Proper diameter is NOT installed in indoor coil. Proper orifice diameter must be ordered separately. The orifice MUST be replaced with proper orifice shown.

APPLICATION

FIGURE 2
TYPICAL APPLICATION OF
COIL TO HIGHBOY FURNACE

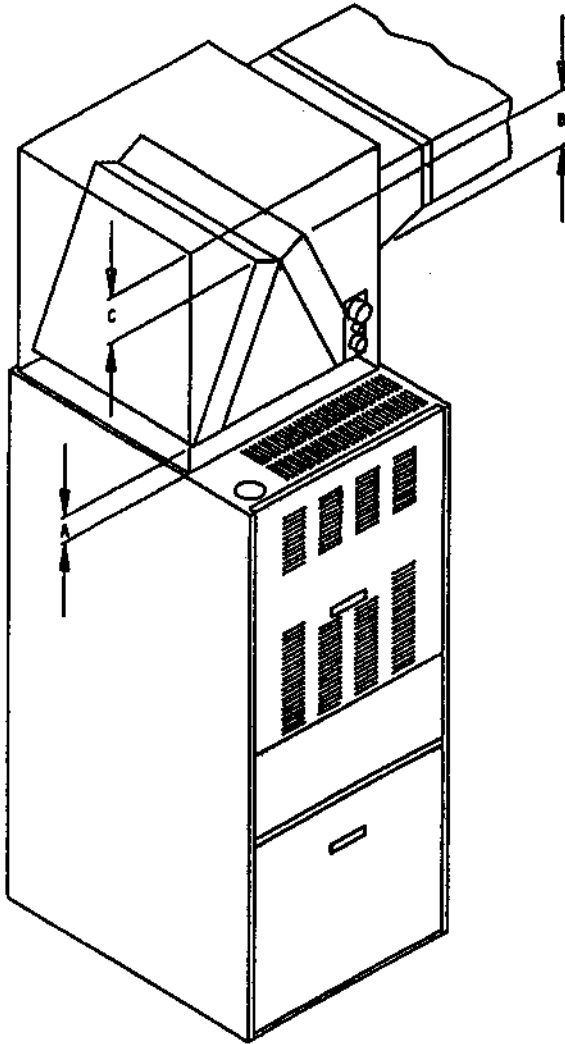
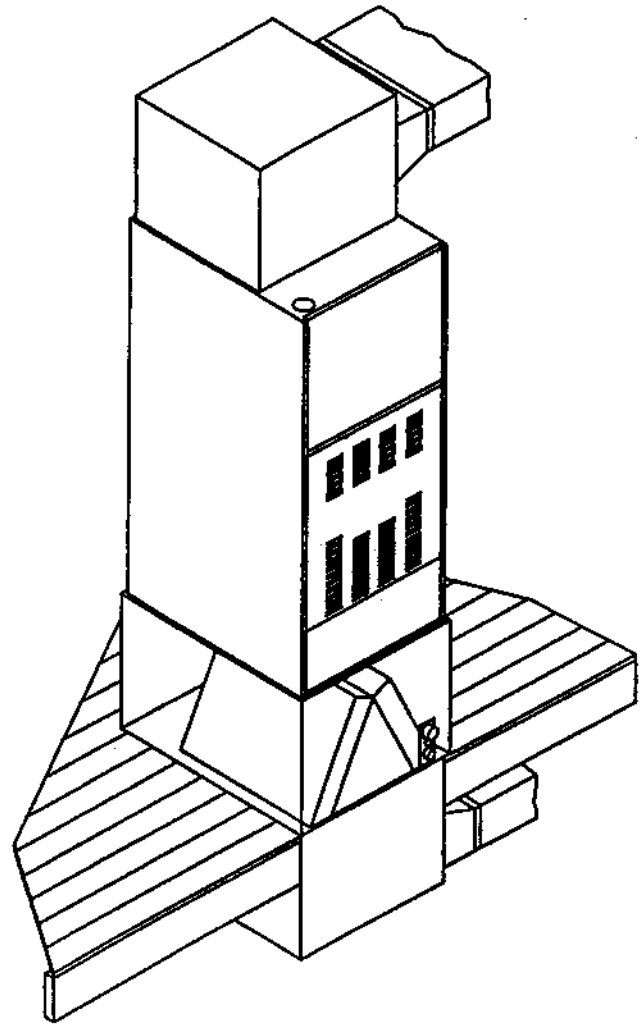

FIGURE 3
TYPICAL APPLICATION OF COIL
COUNTERFLOW FURNACE



Every coil must have the required two inch minimum clearance between furnace heater exchanger and bottom of coil (Figure 2, dimension A), and not exceed a maximum of two inches between the top of coil and bottom of horizontal ductwork (Figure 2, dimension B).

When the ductwork takes off from only one side of the plenum, the minimum distance from top of coil to top of plenum is six inches (Figure 2, dimension C).

A duct should never be located between the coil and the source of air supply. If your coil is larger than the top of your furnace, a transition is required with a minimum of three inches.

CAUTION: Be sure to seal area on all sides between coil drain pan and plenum to prevent air from bypassing coil.

It is important to provide a removable access door in the plenum slightly larger than the coil for servicing or cleaning the coil.

EXPANSION DEVICE

The flow control orifice provides the function of the expansion device as well as distributes the refrigerant equally to all evaporator circuits. It features a "take apart" brass body which houses a removable piston-orifice assembly which meters the proper amount of refrigerant flow and serves as the expansion device. This orifice can be removed and replaced.

There is an orifice shipped installed with the flow control in each coil. Refer to Table 2 to find if the orifice shipped installed is matched to the outdoor unit. Example: Outdoor unit 30UACQA with A30AQ-A is a matched combination. For other combinations of indoor coil to outdoor unit application, the orifice in the flow control device **MUST** be changed to the size shown in the chart on Table 2. An additional proper sized orifice to be used with each outdoor unit is shipped packaged in the envelop with the installation instructions, with each outdoor unit. The installer should mark the size of the orifice installed on the rating plate of the indoor coil. The diameter of the orifice is stamped on the side of the brass orifice and on the plastic bag. Example: 063 indicates the orifice is .063" inside diameter.

CAUTION: Be sure there is no dirt introduced into the distributor--orifice assembly. Be sure and install the orifice with the bullet nose pointing in the proper direction as shown in Figure 4. Failure to do so will result in improper operation.

NOTE: If the orifice does not have to be changed, skip the instructions outlined further in Figure 4 and proceed to Figures 5 or 6 as applicable.

FIGURE 4
FLOW CONTROL ASSEMBLY
FIELD RESTRICTOR REPLACEMENT INSTRUCTIONS

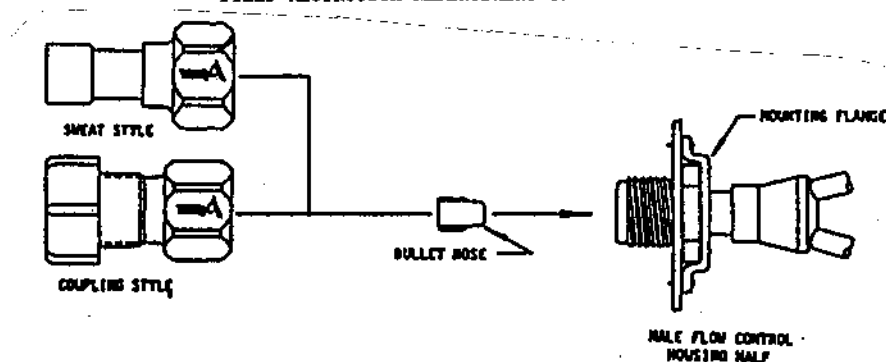

NOTE: DO NOT CONNECT LINE SETS! If restrictor needs to be changed, change out restrictor first.

STEP 1 Remove charge/pressure from indoor unit (if necessary--coupling style).

STEP 2 Disassemble Flow Control Assembly by turning body hex.

STEP 3 If existing restrictor has not dropped out of the body when disassembled, remove by using a pin or paper clip. Discard this original restrictor.

STEP 4 Insert properly sized restrictor fully into the flow control body with rounded "bullet" nose towards the unit as shown. Insure the restrictor stays inserted in body before connecting mating half. See Table 2 for proper size.

STEP 5 Thread assembly halves together by hand to insure proper mating of threads and tighten until bodies "bottom" or a definite resistance is felt.

STEP 6 Using a marker pen or ink pen, mark a line lengthwise from the union nut to the bulkhead. Then tighten an additional 1/6 turn (or 1 hex flat). The misalignment of the line will show the amount the assembly has been tightened. This final 1/6 turn is necessary to insure the formation of the leakproof joint.

STEP 7 Complete piping and installation of unit per installation instructions. See Figure 5 for detailed assembly instructions for sweat type and Figure 6 for detailed assembly instructions for coupling type coils.

CAUTION WHEN USING 5780 SERIES COUPLINGS

If coupling is every disconnected, the Flow Control Assembly connection may also be loosened. If this should occur, care must be taken to avoid loss of the restrictor. If loosened, repeat Step 5 above to insure the reformation of leakproof joint.

FIGURE 5
FLOW CONTROL FIELD ASSEMBLY PROCEDURES
SWEAT STYLE LINE SET

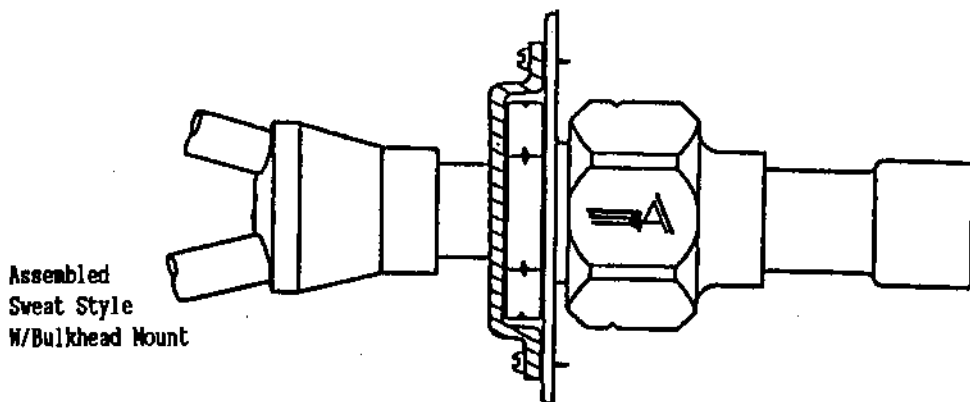

STEP 8 Route the suction and liquid lines between the indoor and outdoor units.

STEP 9 The tubing should be cut square. Make sure it is round and free of burrs at the connecting ends, clean the tubing to prevent contaminants from entering the system.

STEP 10 Wrap a wet rag around the union nut of the flow control assembly.

STEP 11 Sparingly apply paste flux to the copper tube and insert into stub. Excessive or liquid flux can run inside assembly and cause corrosion. No flux is necessary if a low or zero silver braze alloy is used.

STEP 12 After brazing, quench with a wet rag to cool the joint and remove any flux residue.

STEP 13 Evacuate the lines and indoor coil before opening the base valves. Refer to instructions packed with the outdoor unit for details on setting the proper refrigerant charge.

FIGURE 6
FLOW CONTROL FIELD ASSEMBLY PROCEDURES
PRECHARGE COUPLING LINE SET

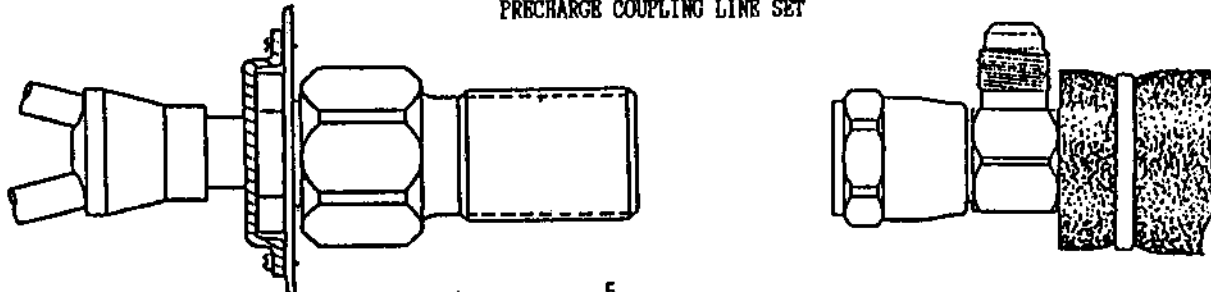

- STEP 8** Route the suction and liquid line between the indoor and outdoor unit. **CAUTION:** Do NOT connect the tubing to the outdoor unit yet.
- STEP 9** Remove protector caps and plugs.
- STEP 10** If necessary, carefully wipe coupling seats and threaded surfaces with a clean cloth to prevent the inclusion of dirt or any foreign material in the system.
- STEP 11** LUBRICATE male half diaphragm and synthetic rubber seal with refrigerant oil. Thread coupling halves together by hand to insure proper mating of threads. Use proper size wrenches (on line set coupling body hex and on union nut) and tighten until coupling bodies "bottom" or a definite resistance is felt.
- STEP 12** Using a marker or ink pen, mark a line lengthwise from the coupling union nut to the bulkhead. Then tighten an additional 1/4 turn; the misalignment of the line will show the amount the coupling has been tightened. This final 1/4 turn is necessary to insure the formation of leakproof joint. If a torque wrench is used, torque values recommends 10 to 12 foot pounds.
- STEP 13** Evacuate the lines and indoor unit before connecting to the outdoor unit. Refer to the installation instructions packed with the outdoor unit for details on setting the proper refrigerant charge. **NOTE:** The lines and indoor coil do not have to be evacuated if they were not opened to the atmosphere to change the orifice.

AIRFLOW PRESSURE DROP MEASUREMENT

A manometer or air draft gauge is required to check the air pressure drop across the indoor evaporator coil section.

The pressure (or positive) side of the gauge should connect to the air inlet (entering) side of the coil, and the suction (or negative) side of the gauge to the downstream (leaving) side of the coil. See Figure 7.

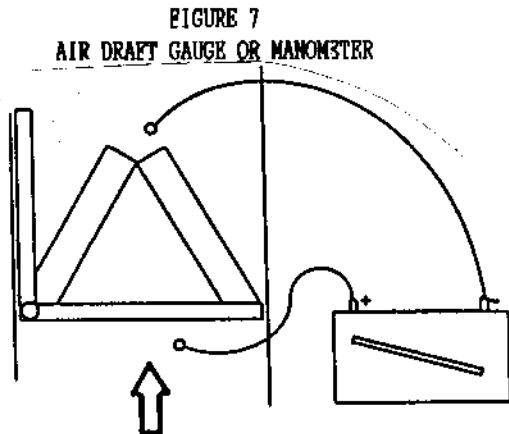

CFM FOR ADD-ON COILS

The furnace that you are going to add a heat pump to must be able to deliver enough air to satisfy the airflow listed in Table 2 for the coil being used.

In a heat pump application, the indoor coil becomes the condensing coil, this is why the amount of air is so critical. Not enough air results in too high of high side pressures and temperatures. The furnace CFM can be calculated by using the following formula:

$$CFM = \frac{\text{Output (BTU/H)}}{1.08 \times \text{Temp. Rise}}$$

When adding a coil to an existing GAS FURNACE, proceed as follows to determine the gas input to the furnace. Shut off all other gas appliances in the home, then set the indoor wall thermostat to call for heat. Go to the gas meter and clock the fastest moving dial, then refer to the chart below.

EXAMPLE: Most gas utilities use 1000 BTU per cubic foot of gas. If you were to clock the one cubic foot dial and found it took 36 seconds for one revolution, then in one hour the furnace would use 100,000 BTU, but we all know that no furnace is 100 percent efficient, so suppose we assume this furnace to be 70 percent efficient, then we should have approximately 70,000 BTU per hour output. Using the figure our formula would look like this:

$$\text{CFM} = \frac{70,000}{1.08 \times \text{T.R.}} \quad \text{or} \quad \text{CFM} = \frac{70,000}{1.08 \times ?}$$

We must still obtain a temperature rise through the furnace. This is done by measuring the return air temperature and the supply air temperature. Let's again assume we were able to measure a 60 degree F temperature rise through the furnace. Now we can complete our formula.

$$\text{CFM} = \frac{70,000}{1.08 \times 60} \quad \text{or} \quad \text{CFM} = \frac{70,000}{65}$$

Then, our CFM for this furnace would be 1076 CFM.

TABLE 3

Seconds For One Rev.	SIZE OF TEST DIAL					Seconds For One Rev.	SIZE OF TEST DIAL				
	1/4 Cu. Ft.	1/2 Cu. Ft.	1 Cu. Ft.	2 Cu. Ft.	5 Cu. Ft.		1/4 Cu. Ft.	1/2 Cu. Ft.	1 Cu. Ft.	2 Cu. Ft.	5 Cu. Ft.
10	90	180	360	720	1800	36	25	50	100	200	500
11	82	164	327	655	1636	37	--	--	97	195	486
12	75	150	300	600	1500	38	23	47	95	189	474
13	69	138	277	555	1385	39	--	--	92	185	462
14	64	129	257	514	1286	40	22	45	90	180	450
15	60	120	240	480	1200	41	--	--	--	176	439
16	56	113	225	450	1125	42	21	43	86	172	429
17	53	106	212	424	1059	43	--	--	--	167	419
18	50	100	200	400	1000	44	--	41	82	164	409
19	47	95	189	379	947	45	20	40	80	160	400
20	45	90	180	360	900	46	--	--	78	157	391
21	43	86	171	343	857	47	19	38	76	153	383
22	41	82	164	327	818	48	--	--	75	150	375
23	39	78	157	313	783	49	--	--	--	147	367
24	37	75	150	300	750	50	18	36	72	144	360
25	36	72	144	288	720	51	--	--	--	141	355
26	34	69	138	277	692	52	--	--	69	138	346
27	33	67	133	267	667	53	17	34	--	136	340
28	32	64	129	257	643	54	--	--	67	133	333
29	31	62	124	248	621	55	--	--	--	131	327
30	30	60	120	240	600	56	16	32	64	129	321
31	--	--	116	232	581	57	--	--	--	126	316
32	28	56	113	225	563	58	--	31	62	124	310
33	--	--	109	218	545	59	--	--	--	122	305
34	26	53	106	212	529	60	15	30	60	120	300
35	--	--	103	206	514						

If the furnace is equipped with a direct drive motor, make sure you have it wired to high speed tap. If it is a belt drive motor, then read the motor's nameplate amps. Then hook on an amp probe and see if it is possible to speed the blower up by adjusting the variable pulley.

If you are at the limits of the motor, then check with the furnace manufacturer to see if a larger horsepower motor can be installed and also if the blower will give you the needed CFM with a larger motor.

When you have determined that your furnace can handle the required CFM for your coil, the indoor coil must be installed and your CFM calculation must be rechecked with the coil in place.

When adding to an OIL FURNACE, you must determine what size nozzle the unit has in the burner and then install a pressure gauge in the oil delivery pumps discharge port and set the pressure at 100 psig. An example might be that we find the burner equipped with a one gallon per hour nozzle, operating at 100 psi. This nozzle will deliver one G.P.H. and a gallon of No. 2 fuel oil has approximately 140,000 BTU of heat.

The 140,000 BTU is our input and again let us assume that this furnace is operating at 70 percent efficiency. Then our BTU output is 98,000 BTU, and if we use the rule of thumb that an oil furnace should operate with an 85 degree F temperature rise, then our formula would look like this:

$$\text{CFM} = \frac{98,000 \text{ BTU/H}}{1.08 \times 85 \text{ degree F}} \quad \text{or} \quad \frac{98,000 \text{ BTU/H}}{92} = 1065 \text{ CFM}$$

When adding on to an electric furnace, we must also take one more thing into consideration and that is the heat pump coil must be installed on the return side of the electric furnace. To find out what CFM the electric furnace can deliver, we must measure the voltage and amperage of each heating element or Volts x Amp - Watts. The total Watts x 3.4 BTU = BTU Output. An example might look like this with a 15kw electric furnace.

$$\begin{aligned} 240 \text{ Volts} \times 21 \text{ Amps} &= 5,040 \text{ Watts} \\ 5,040 \text{ Watts} \times 3 \text{ Elements} &= 15,120 \text{ Watts} \\ 15,120 \text{ Watts} \times 3.4 \text{ BTU/Watt} &= 51,408 \text{ BTU} \end{aligned}$$

One word of caution, never go by nameplate rating. Always measure volts and amps.

One more item that is different with an electric furnace and that is, never obtain a supply air temperature reading in sight of the electric element (because of the radiant affect). Now our formula looks like this again:

$$\text{CFM} = \frac{51408 \text{ BTU/H}}{1.08 \times 44 \text{ degree F}} \quad \text{or} \quad \frac{51408 \text{ BTU/H}}{48} = 1071 \text{ CFM}$$

CONDENSATE DRAIN TRAP

It is very important to provide a trap in the condensate drain line to allow a positive liquid seal in the line and assure correct drainage from the coil condensate pan.

Install condensate drain trap shown below. Use drain connection size or larger. Do not operate unit without trap. Unit must be level or slightly inclined toward drain.

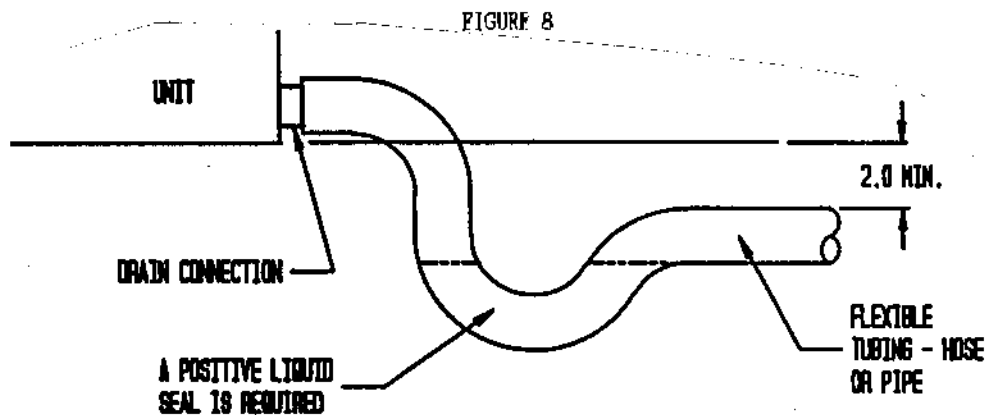

II. WIRING

GENERAL OPERATION--HEAT PUMP/FOSSIL FUEL FURNACE

This type of system is a one-stage heating system, even though a two-stage heat wall thermostat is used. The thermostats specified for use are special thermostats for heat pumps with extra switches, signal lights, and special circuitry for heat pumps, and by design are two-stage heating thermostats. Since the extra features are also required for the special heat pump/fossil fuel systems, the same thermostats are used, but the second stage circuit is not used. This is further explained in the next paragraph.

While it would be possible to electrically connect the furnace to the second stage of the thermostat, the heat pump coil is located downstream from the furnace heat exchanger, and continuous simultaneous operation of the furnace and heat pump will result in excessive high discharge pressures and temperatures at the compressor and resultant overload tripping problems. For this reason, the control circuit wiring diagrams shown later in this manual will not allow the furnace to operate except during defrost cycles unless an outdoor thermostat is added to the circuit. The addition of an outdoor thermostat used as a changeover thermostat will switch the system from heat pump heating to furnace heating based on the outdoor temperature. At no time will continuous operation of the heat pump and furnace be allowed.

An outdoor thermostat is used as a changeover thermostat, properly set to control at or just above the balance point, will allow the most economical operation of the system. The changeover (outdoor) thermostat switches off the heat pump and on the fossil fueled furnace, based on the outdoor temperature. There is a 5 degree F differential in the changeover (outdoor) thermostat, so when the heat pump is de-energized and the furnace is activated, the outdoor temperature must rise 5 degrees F above the set-point of the thermostat to stop the furnace and start the heat pump again. NOTE: See manual 2100-057 "Heat Pump Sizing" for procedure to determine correct balance point.

The emergency heat switch allows for manual cutoff of the heat pump and operation of the furnace at any outdoor temperature.

NOTE ON INDOOR BLOWER OPERATION

Because of the design of the heat pump wall thermostats, and the fact that a cooling blower relay is installed in parallel with the fan side of the combination fan/limit control found on most gas or oil furnaces, the furnace blower will start as soon as the wall thermostat calls for heat. This is required for the heat pump and will also occur during the time when the heat pump is off and the furnace is operating. This is contrary to normal blower operation on a gas or oil furnace and is sometimes misunderstood, but an inherent part of the system operation. While in the gas or oil furnace mode of operation, there will still be a run-on in blower operation until the bonnet temperature cools down to the blower off setting of the fan/limit switch.

CONTROL CIRCUIT WIRING

There are two (2) separate control diagrams for fossil fuel furnaces with heat pumps, and two (2) control diagrams for fossil fuel furnaces with air conditioning.

TABLE 4

Air Conditioning System	Gas Furnace Control Diagram	Oil Furnace Control Diagram
All	4091-100	4091-101

TABLE 5

Heat pump system	Gas furnace control diagram	Oil furnace control diagram
18HPQ 24UHPQA 24HPQ 30UHPQA 30HPQ 36UHPQA 36HPQ	4091-200	4091-201
42HPQ 60HPQ 48HPQ	4091-202	4091-203

WALL THERMOSTATS

The following wall thermostats and subbases should be used as indicated, depending on the application.

TABLE 6

AIR CONDITIONING THERMOSTATS		
Part No.	Model No.	Description
8403-002	T87F3111	THERMOSTAT--1 stg. heat, adj. heater, Mercury
8404-003	Q539A1220	SUBBASE --System Heat-Off-Cool Fan: On-Auto
8403-008	ID51-605	THERMOSTAT--1 stg. cool, System w/Off Sw. Snap Action Fan: Auto-On
8403-009	IF56-318	THERMOSTAT--1 st. cool, 1 stg. heat, Adj. heater Mercury System: Heat-Off-Cool Fan: Auto-On
8403-019	T874C1000	THERMOSTAT--1 stg. cool, 2 stg. heat, Adj. heater, Mercury
8404-012	Q674A1001	SUBBASE --System: Heat-Auto-Cool Fan: Auto-On
HEAT PUMP THERMOSTATS		
Part No.	Model No.	Description
8403-017	T874R1129	THERMOSTAT--1 stg. cool, 2 stg. heat, 1st stage fixed, 2nd stg. adj. heat anticipators
8404-009	Q674L1181	SUBBASE --System switch: Em. Heat-Heat-Off-Cool Fan switch: On-Auto SPECIAL FEATURE: Manual Changeover (Non-Cycling Rev. Valve) Em. heat light and System check light
8403-018	T874N1024	THERMOSTAT--1 stg. cool, 2 stg. heat, 1st stage fixed, 2nd stg. adj., heat anticipators
8404-010	Q674F1261	SUBBASE --System switch: Off-Cool-Auto-Heat-Em.Ht. Fan switch: On-Auto SPECIAL FEATURE: Auto system changeover, Em. heat light and System check light
8403-024	IF58-45	THERMOSTAT--1 stg. cool, 2 stg. heat, 1st stage fixed, 2nd stg. adj. heater System switch: Em. Heat-Heat-Off-Cool Fan Switch: On-Auto

WARNING: Only the thermostats and subbases listed in Table 6 have been approved for use with the 24UHPQA, 30UHPQA, and 36UHPQA models. Use of any other thermostat/subbase combination can cause a condition of no blower operation during defrost cycle when auxiliary heat is energized causing an unsafe condition and possible fire.

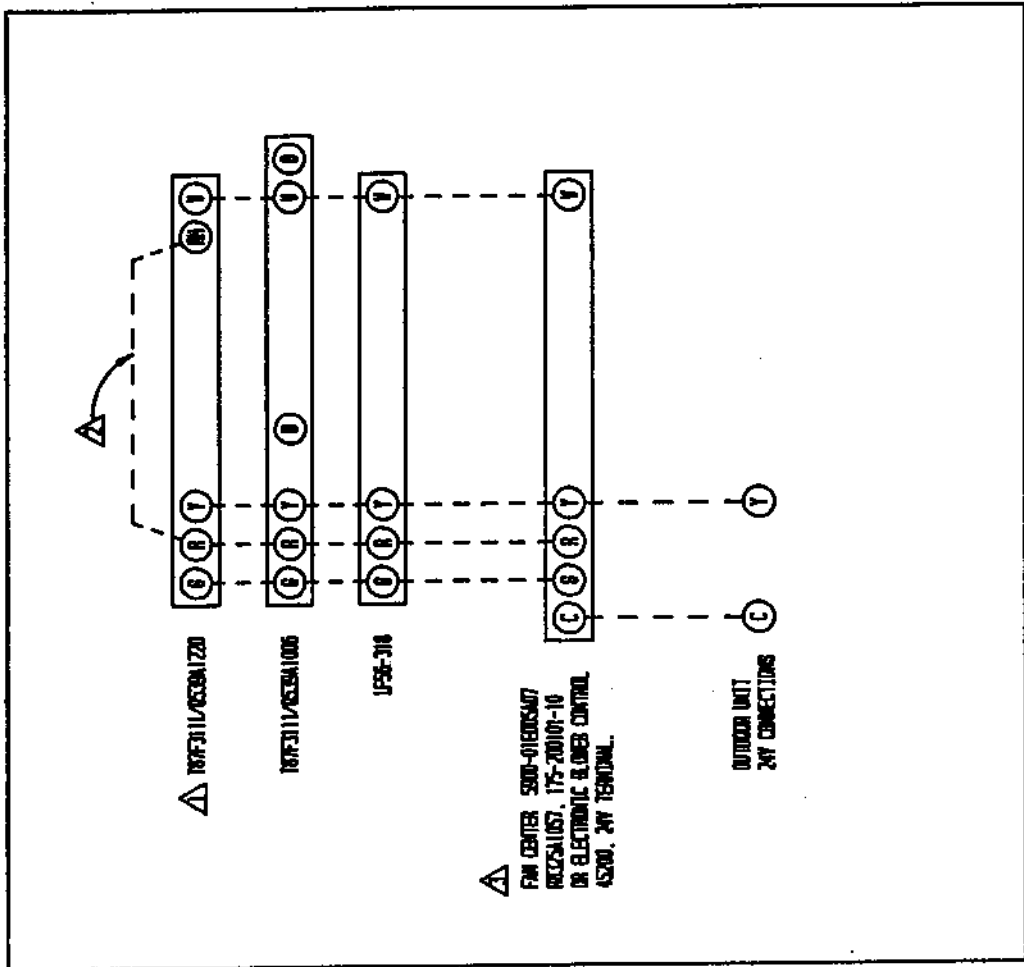

△ SET ADJUST HEAT ANTICIPATOR (SEE FURNACE INSTALLATION INSTRUCTIONS)
 △ INSTALL JUMPER P-W
 △ IF THE FURNACE IS NOT INTERNALLY WIRED FOR AOD ON AIR CONDITIONING, A FAM CENTER WILL NEED TO BE ADDED.

LOW VOLTAGE	FACTORY WIRING	FIELD WIRING
HIGH VOLTAGE	---	---

AIR CONDITIONER V/GAS FURNACE

4091-100

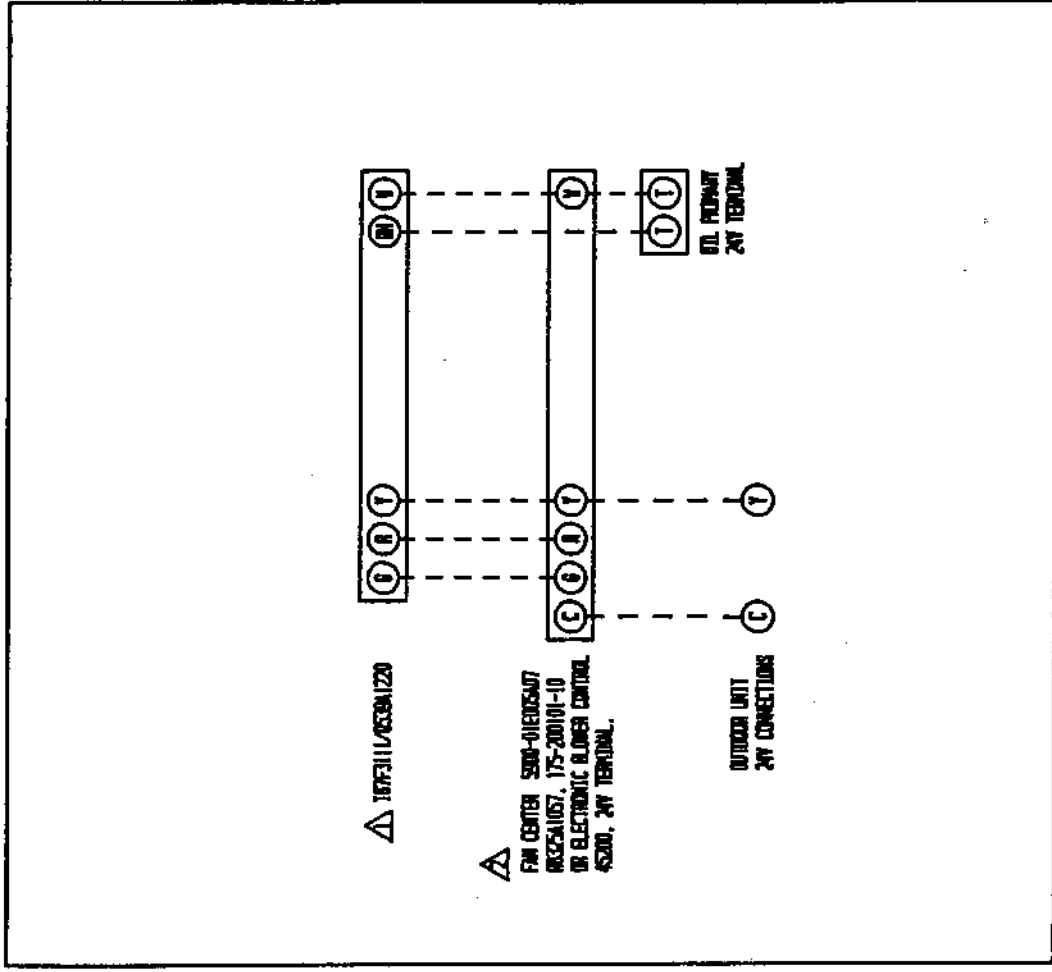

△ SET ADJUST HEAT ANTICIPATOR (SEE FURNACE INSTALLATION INSTRUCTIONS)
 △ IF THE FURNACE IS NOT INTERNALLY WIRED FOR AOD ON AIR CONDITIONING, A FAM CENTER WILL NEED TO BE ADDED.

LOW VOLTAGE	FACTORY WIRING	FIELD WIRING
HIGH VOLTAGE	---	---

AIR CONDITIONER V/OIL FURNACE

4091-101

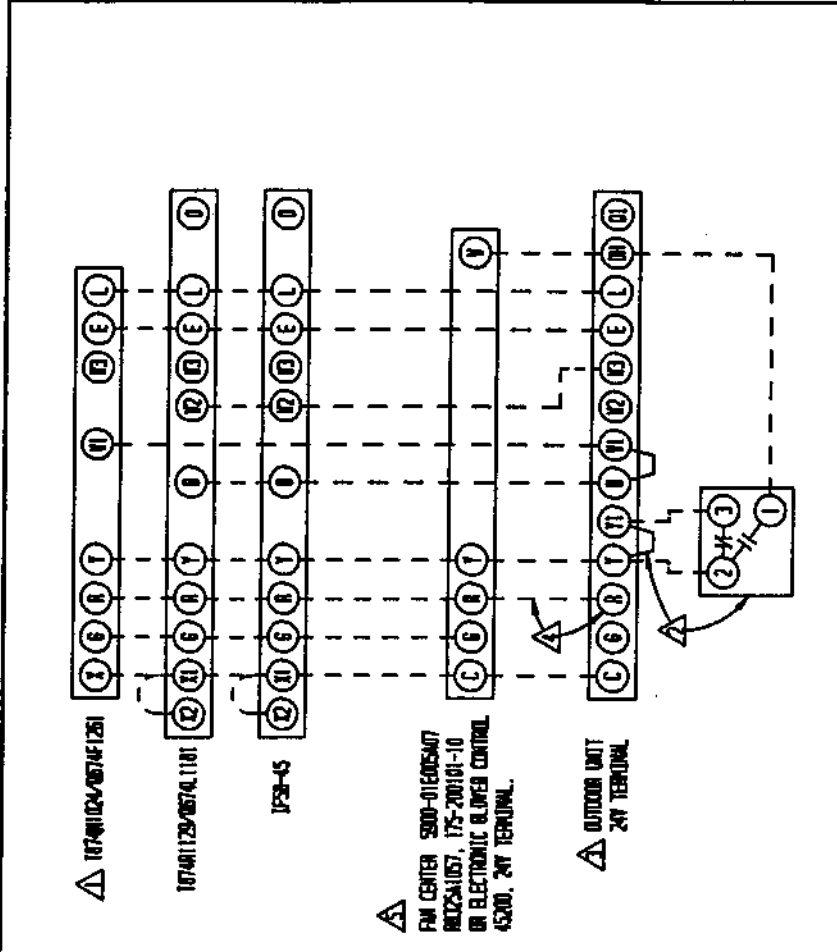

▲ SET ADJUST HEAT ANTICIPATOR (SEE FURNACE INSTALLATION INSTRUCTIONS)
 ▲ WHEN OUTDOOR THERMOSTAT (USED AS CHANGEOVER THERMOSTAT) IS INSTALLED, REMOVE JUMPER Y-Y1.
 ▲ IF IT DESIRED NOT TO ALLOW FURNACE TO CYCLE "ON" DURING DEFROST, A 24V FACTORY WIRE RETURN (TERMINAL "3" OF DEFROST RELAY AND TERMINAL "4" OF EMERGENCY HEAT RELAY ON HPV MODELS OR TERMINAL ② OF HEATPUMP CONTROL AND TERMINAL ③ ON TERMINAL BOARD ON HPV MODELS) MUST BE REMOVED.
 ▲ HPV SERIES MODEL DO NOT HAVE ④ TERMINAL AND IT IS NOT REQUIRED TO RUN ④ WIRE TO THESE MODELS.
 ▲ IF THE FURNACE IS NOT INTERNALLY WIRED FOR AOD ON AIR CONDITIONS, A FAN CENTER WILL NEED TO BE ADDED.

FACTORY WIRING	FIELD WIRING
LOW VOLTAGE	---
HIGH VOLTAGE	---

HEAT PUMP V/GAS FURNACE

4081-200

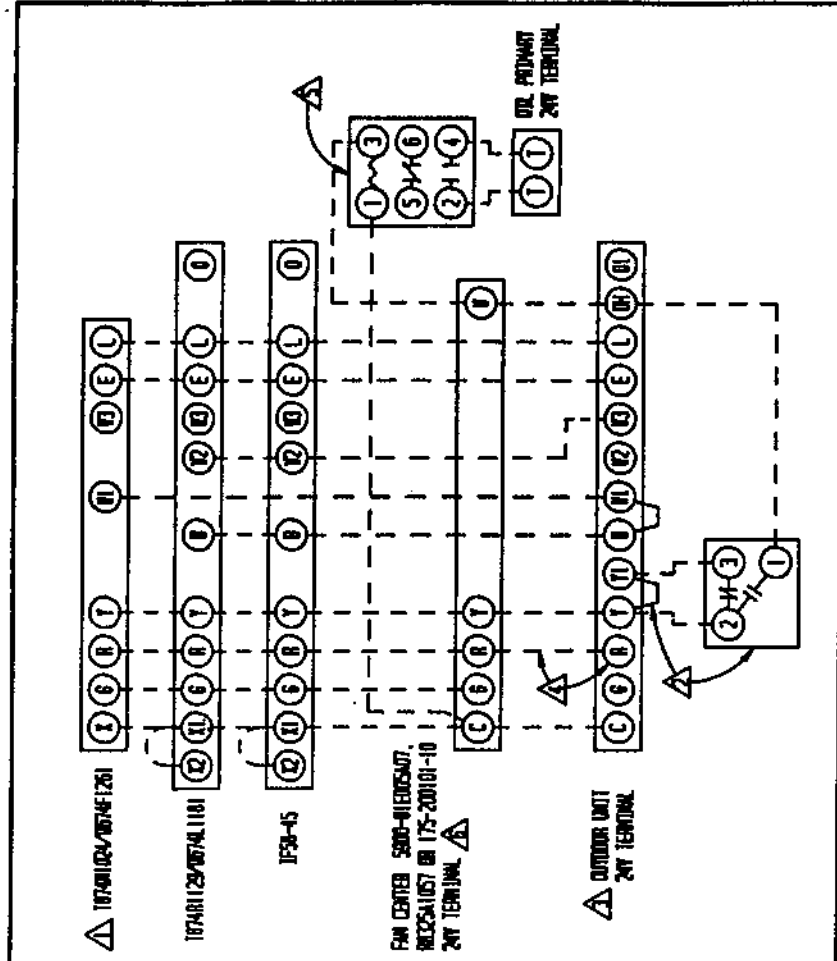

▲ SET ADJUST HEAT ANTICIPATOR (SEE FURNACE INSTALLATION INSTRUCTIONS)
 ▲ WHEN OUTDOOR THERMOSTAT (USED AS CHANGEOVER THERMOSTAT) IS INSTALLED, REMOVE JUMPER Y-Y1.
 ▲ IF IT DESIRED NOT TO ALLOW FURNACE TO CYCLE "ON" DURING DEFROST, A 24V FACTORY WIRE RETURN (TERMINAL "3" OF DEFROST RELAY AND TERMINAL "4" OF EMERGENCY HEAT RELAY ON HPV MODELS OR TERMINAL ② OF HEATPUMP CONTROL AND TERMINAL ③ ON TERMINAL BOARD ON HPV MODELS) MUST BE REMOVED.
 ▲ HPV SERIES MODEL DO NOT HAVE ④ TERMINAL AND IT IS NOT REQUIRED TO RUN ④ WIRE TO THESE MODELS.
 ▲ LOCATE ISOLATING RELAY IN OIL FURNACE. NECESSARY TO SEPARATE 24V POWER SUPPLY OF HEATPUMP FROM 24V POWER SUPPLY BUILT INTO OIL BURNER MAINMANT CONTROL.
 ▲ IF THE FURNACE IS NOT INTERNALLY WIRED FOR AOD ON AIR CONDITIONS, A FAN CENTER WILL NEED TO BE ADDED.

FACTORY WIRING	FIELD WIRING
LOW VOLTAGE	---
HIGH VOLTAGE	---

HEAT PUMP V/OIL FURNACE

4081-201