

INSTALLATION INSTRUCTIONS

MODELS

CGA-1	High Pressure Control
CGAH-2	Low Pressure Control
CGA-3	Dual Pressure Control
CGA-5	Low Ambient Control A/C
CGH-6	Low Ambient Control H/P
CGA-7	High Pressure Control and Time Delay Relay
CGA-8	High Pressure Control and Low Ambient Control
CGAH-9	Low Pressure Control and Time Delay Relay
CGA-10	Low Pressure Control and Low Ambient Control A/C
CGH-11	Low Pressure Control and Low Ambient Control H/P
CGA-12	Low Pressure Control, Time Delay Relay, and Low Ambient Control A/C
CGH-13	Low Pressure Control, Time Delay Relay, and Low Ambient Control H/P
CGA-14	Dual Pressure Control and Time Delay Relay
CGA-15	Dual Pressure Control and Low Ambient Control
CGA-16	Dual Pressure Control, Time Delay Relay, and Low Ambient Control
CGA-17	Low Ambient Control and Time Delay Relay A/C
CGH-18	Low Ambient Control and Time Delay Relay H/P

OPTIONAL CONTROL GROUP KITS FOR USE WITH MODELS

1-1/2 - 5 TON
WALL MOUNTED PACKAGE AIR CONDITIONERS

1-1/2 - 5 TON
WALL MOUNTED PACKAGE HEAT PUMPS

WAG SERIES
WALL MOUNTED GAS/ELECTRIC MODELS

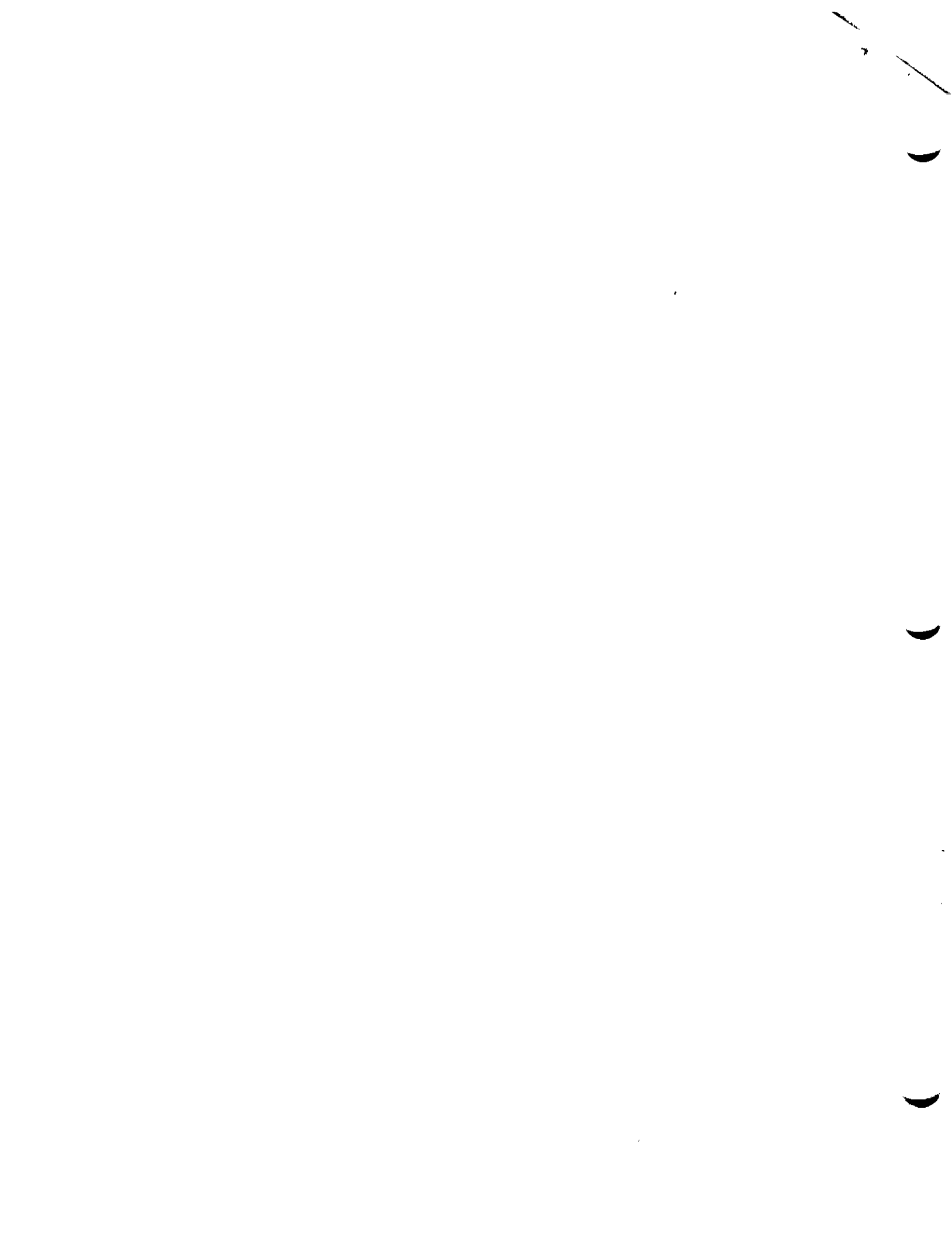

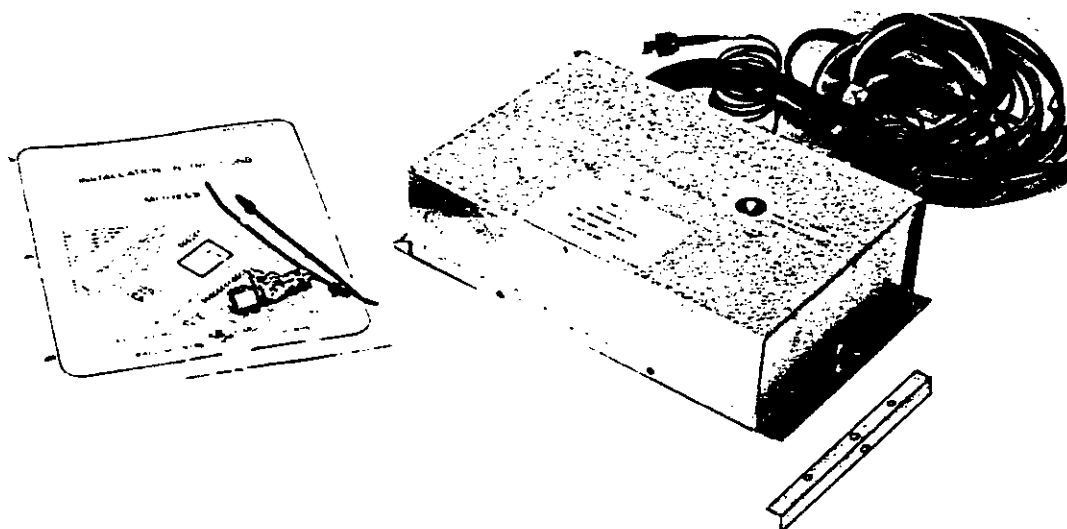
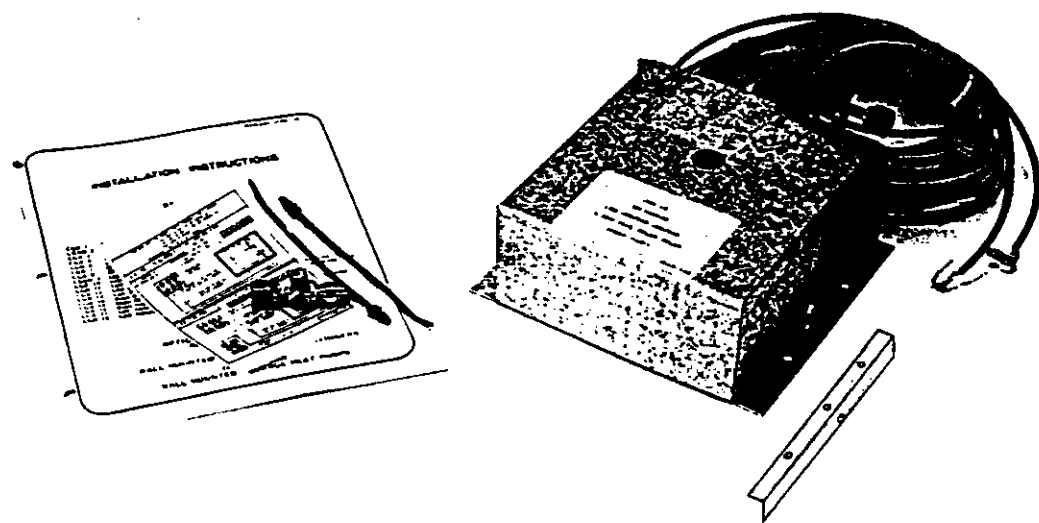

Figure 1

IMPORTANT

The equipment covered in this manual is to be installed by trained, experienced service and installation technicians.

SHIPPING DAMAGE

Upon receipt of equipment, the carton should be checked for external signs of shipping damage. If damage is found, the receiving party must contact the last carrier immediately, preferably in writing, requesting inspection by the carrier's agent.

UNPACKING

Remove the control from the shipping carton. The control must consist of the following: (See Figure 1)

1. Basic control enclosure with controls.
2. Plastic bag containing mounting hardware, supplemental wiring diagram, installation instructions.
3. Mounting angle for use with WAG series models only.

INSTALLATION

IMPORTANT: Disconnect all power supplies to the air conditioner or heat pump.

20WA, 24WA, 18WH, 24WH: Remove the blower service panel, compressor access panel and control panel cover. Remove the four screws used to secure the blower assembly to the blower partition/drain pan assembly. Remove the blower assembly from the slide mount taking care to protect all blower motor leads from damage.

Install the basic control enclosure centered on the compressor partition above the control panel (see Figure 2). Secure the control enclosure to the compressor partition with (2) #10-16x1/2 screws provided in hardware bag.

Route the wires from the control enclosure through the 1" snap bushing located in the compressor partition in the return air area of the unit, through the compressor compartment and into the control panel. Attach wires to controls in panel as per wiring diagram supplied in hardware bag. Use wire tie supplied in hardware bag to tie together any excess wire and place behind control panel.

Route the capillary from the control enclosure through the 1" snap bushing located in the compressor partition in the return air area of the unit and into the compressor compartment. Refer to section A for connection of capillary to service port, and operation for the proper control enclosure.

IMPORTANT: In the 18-24WA/WH units that will also employ an ECW-2A economizer, the control enclosure must be located in the return air opening for proper operation of the economizer.

Slide the blower assembly back into the slide mount and secure the partition/drain pan assembly with the four screws that were removed earlier. Secure the supplemental wiring diagram to control panel cover, resecure the control panel cover, compressor access panel, and blower service panel.

Energize the unit and check for proper system operation.

2-1/2 - 3 ton Remove the blower service panel, compressor access panel, and control panel cover. Remove the four screws used to secure the blower assembly to the blower partition/drain pan assembly. Remove the blower assembly from the slide mount taking care to protect all blower motor leads from damage.

Install the basic control enclosure centered on the compressor partition above the control panel (see Figure 3). Secure the control enclosure to the compressor partition with (2) #10-16x1/2 screws provided in hardware bag.

Route the wires from the control enclosure through the 1" snap bushing located in the compressor partition in the return air area of the unit, through the compressor compartment and into the control panel. Attach wires to controls in panel as per wiring diagram supplied in hardware bag. Secure wires to compressor base with (2) push mount wire ties supplied in hardware bag.

Route the capillary from the control enclosure through the 1" snap bushing located in the compressor partition in the return air area of the unit and into the compressor compartment. Refer to section A for connection of capillary to service port, and operation for the proper control enclosure.

IMPORTANT: In the 30-36WA/WH units that will also employ an ECW-3A economizer, the control enclosure must be located in the return air opening for proper operation of the economizer.

Slide the blower assembly back into the slide mount and secure the partition/drain pan assembly with the four screws that were removed earlier. Secure the supplemental wiring diagram to control panel cover, resecure the control panel cover, compressor access panel, and blower service panel.

Energize the unit and check for proper system operation.

42WA, 49WA, 60WA, 42WH, 48WH, 60WH: Remove the service access panel, control panel cover, and left side grille.

3-1/2 - 5 ton - Remove the service access panel, control panel cover, and left side grille.

Install the basic control enclosure to the left of the control panel in the air conditioner models and behind the control panel in the heat pump models. (Figure 4). Secure the control enclosure to the base with (2) #10-16x1/2 screws provided in the hardware bag.

Route the wires from the control enclosure through 1-7/8" snap bushing in the control panel. Attach wires to controls in panel as per wiring diagram supplied in hardware bag. Secure any excess wire in the blower compartment using the ties supplied with the hardware bag.

Route the capillary from the control enclosure through the 1" snap bushing located in the base and into the compressor compartment. Refer to Section A for connection of the capillary to service port, and operation for the proper control enclosure.

Secure the supplemental wiring diagram to control panel cover, resecure control panel cover, service access panel, and left side grille.

Energize the unit and check for proper system operation.

WAG30A, WAG36A, WAG40A: Remove the blower service panel, control panel cover and right side condenser grille. Fasten the 3/4 x 3/4 x 6" angle to the control module accessory as shown in Figure (5) using #10-16 x 1/2 screw(s) provided. Install the control module to the left of the blower housing securing it to the condenser partition vertical bend with (1) #10-16 x 1/2 screw provided. Do Not attempt to install module accessory without using 3/4 x 3/4 x 6" angle. Damage to the condenser coil may occur if screws protrude downward through condenser partition.

Remove the snap plug (see Figure 5) from the control panel. Route the wires from the control modules into the control panel using the provided strain relief bushing. Using the wire diagram supplied with the module accessory connect the wires to the appropriate points. Use the supplied wire tie to tie together any excess wire and place behind control panel.

Route the capillary from the control enclosure through the 1-1/2" snap bushing used for wire routing located in the condenser partition and into the compressor compartment. Refer to section A for connection of capillary to service port, and for the proper control enclosure.

Attach the supplemental wiring diagram to the control panel cover, secure the control panel cover, blower service panel and right side condenser grille.

Energize the unit and check for proper system operation.

18-24 WA & WH

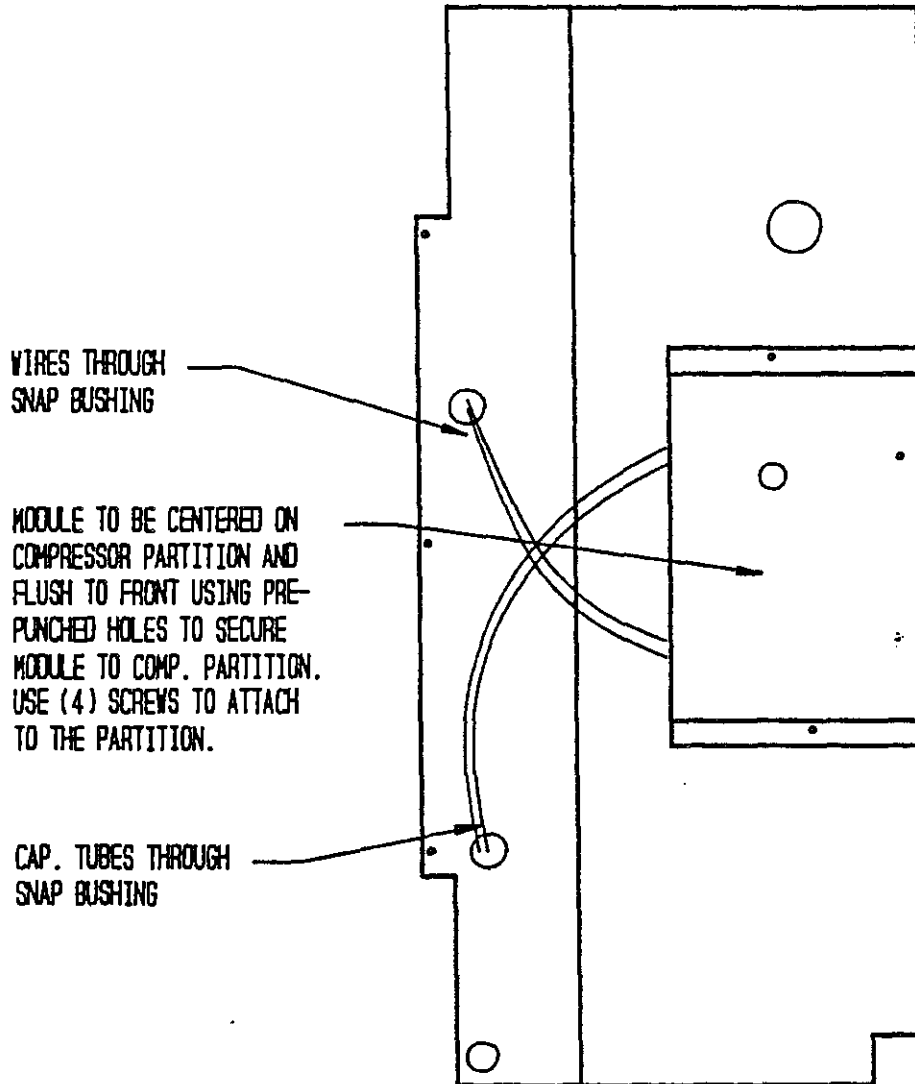

Figure 2.

30-36 WA & WH

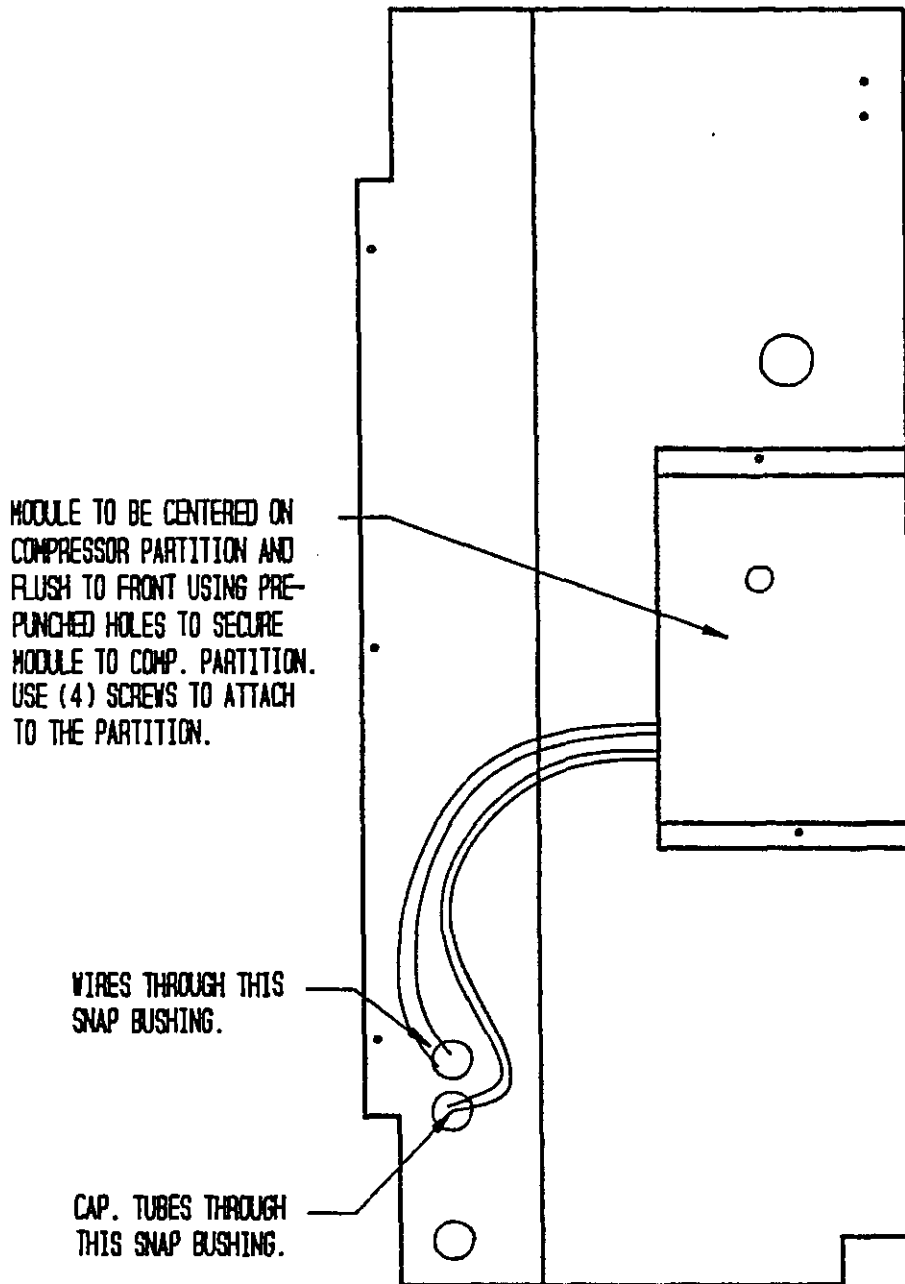

Figure 3.

42, 48-60 WA & WH

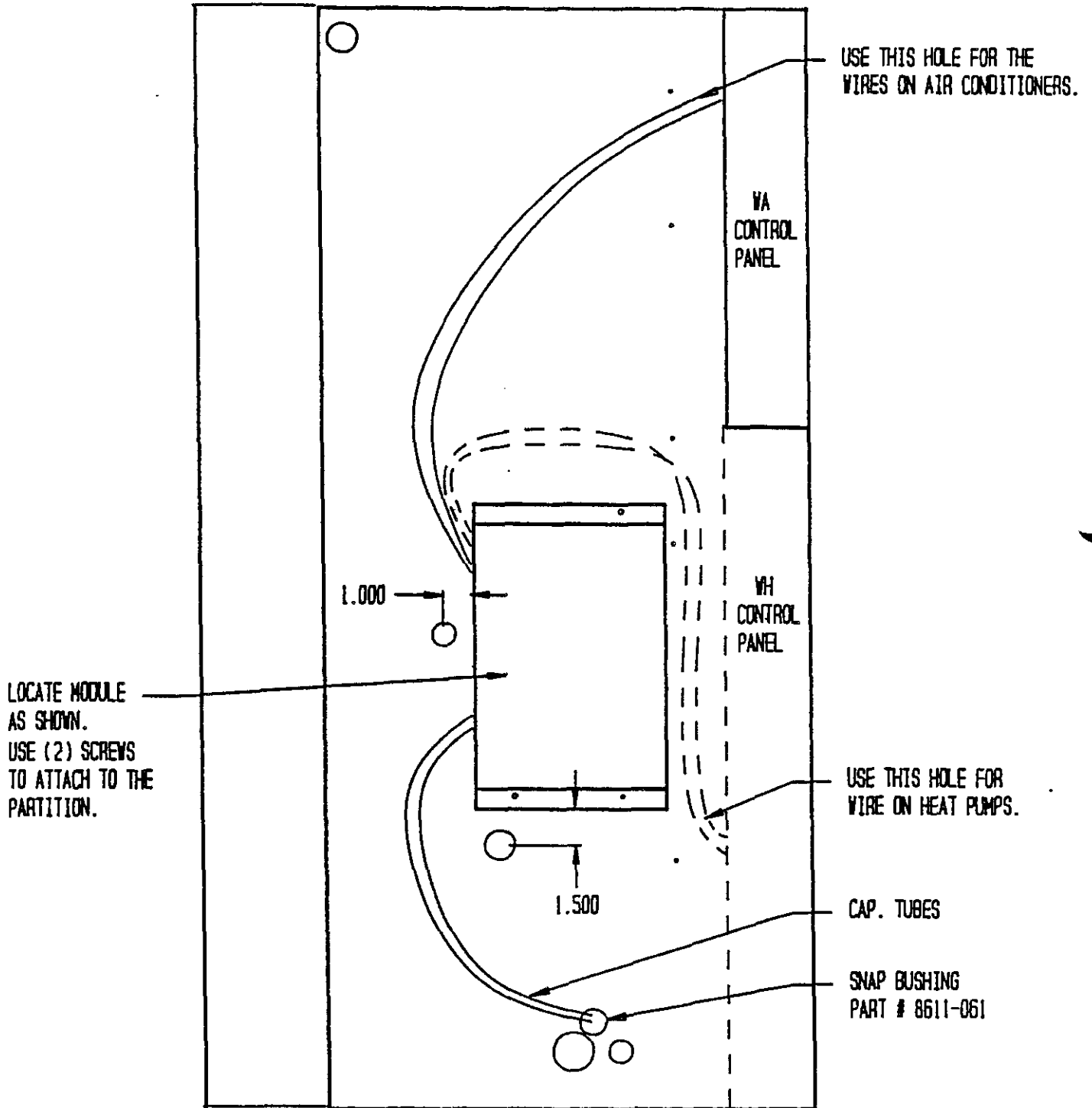

Figure 4.

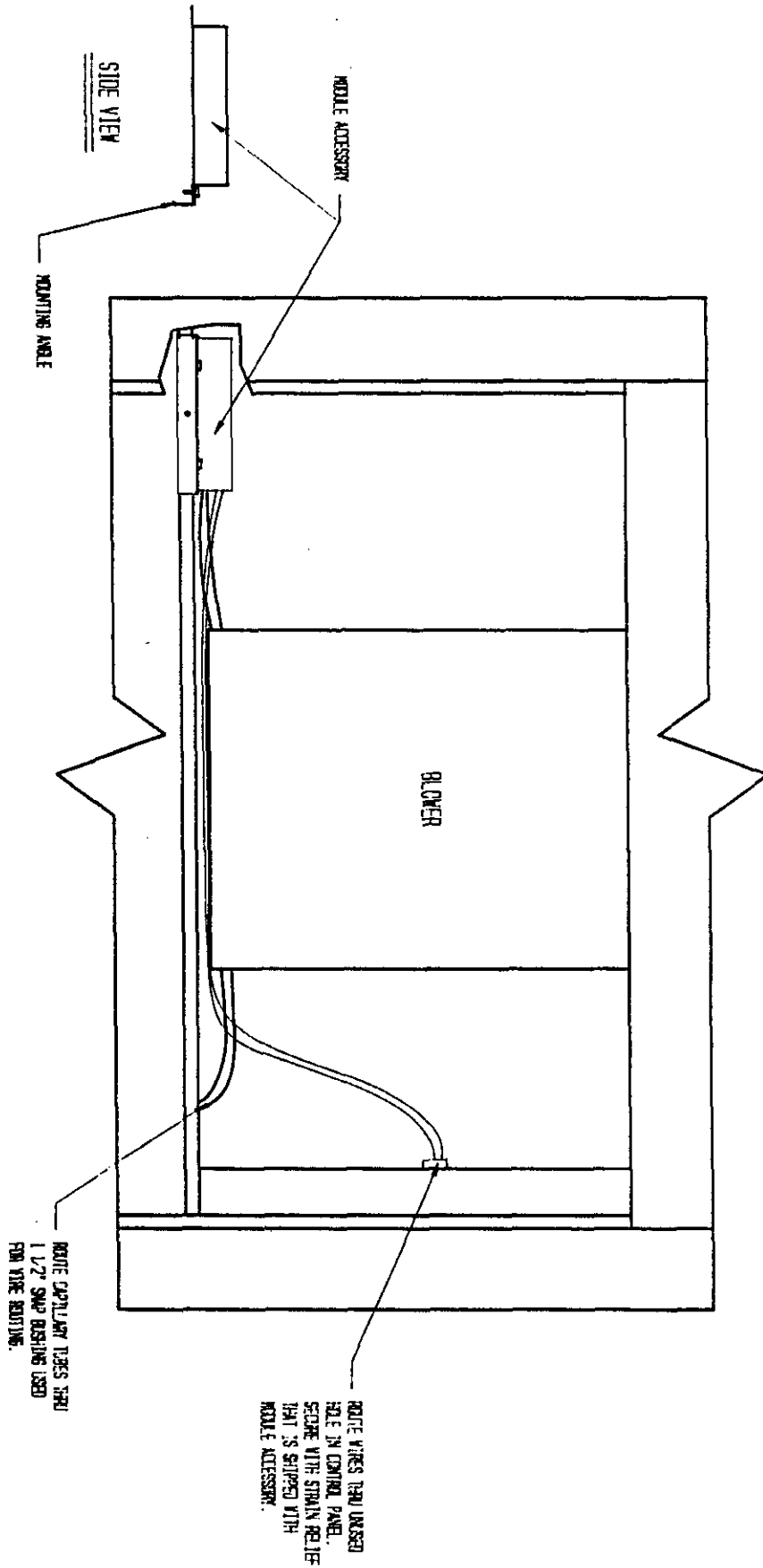

Figure 5

CGA-1
HIGH PRESSURE CONTROL
FOR AIR CONDITIONERS

During operation of the air conditioner the unit will shut off when the system high pressure exceeds the set value of the control (factory set at 425 psig) and will not resume operation until the control is reset by pushing the manual reset button located on the top of the control.

NOTE: Cut-out setting is adjusted if necessary to match specific installation requirements.

CAPILLARY TUBE CONNECTION

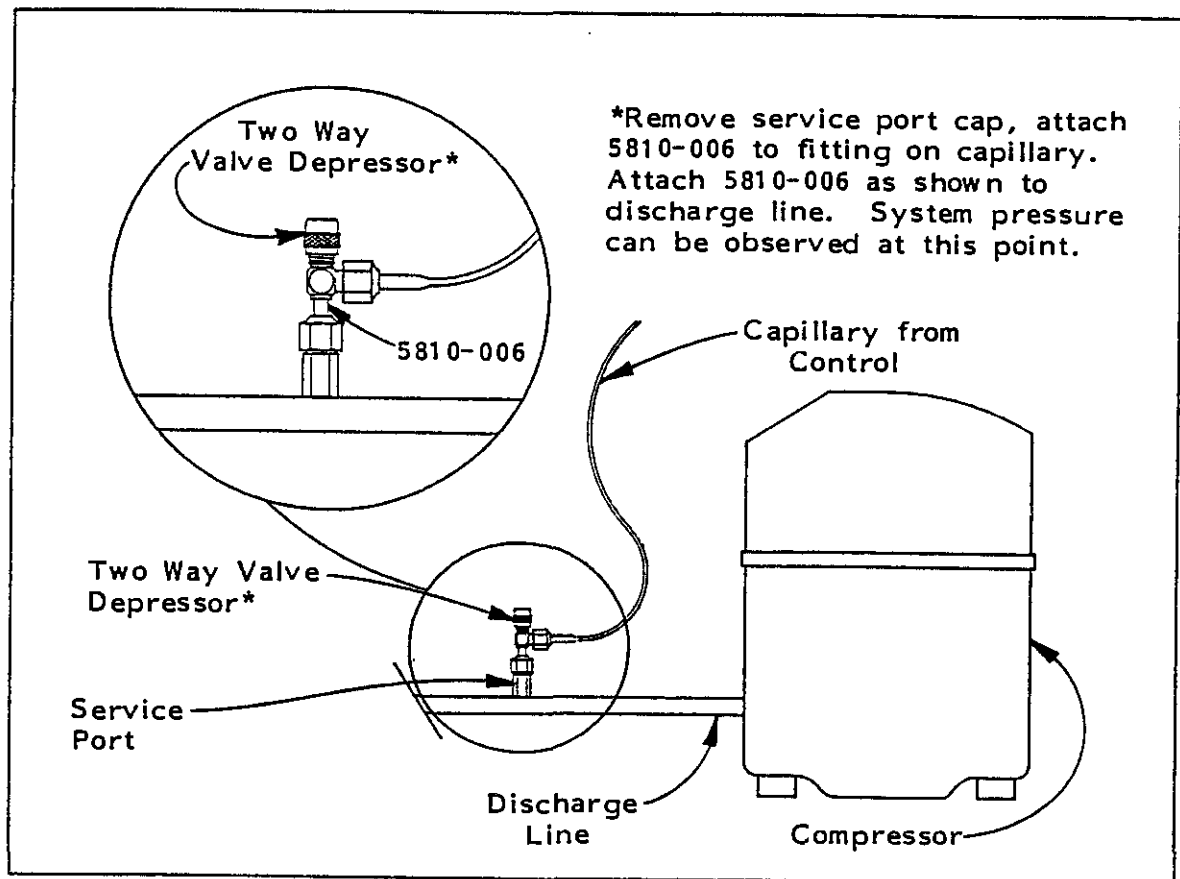

**CGAH-2
LOW PRESSURE CONTROL
FOR AIR CONDITIONERS OR HEAT PUMPS**

During operation of the air conditioner or heat pump the unit will shut off when the system low pressure drops below the set value of the control (factory set at 40 psig for air conditioners, 10 psig for heat pumps) and will not resume operation until the control is reset by pushing the manual reset button located on the top of the control.

NOTE: Cut-out setting is adjustable if necessary to match specific installation requirements.

CAPILLARY TUBE CONNECTION

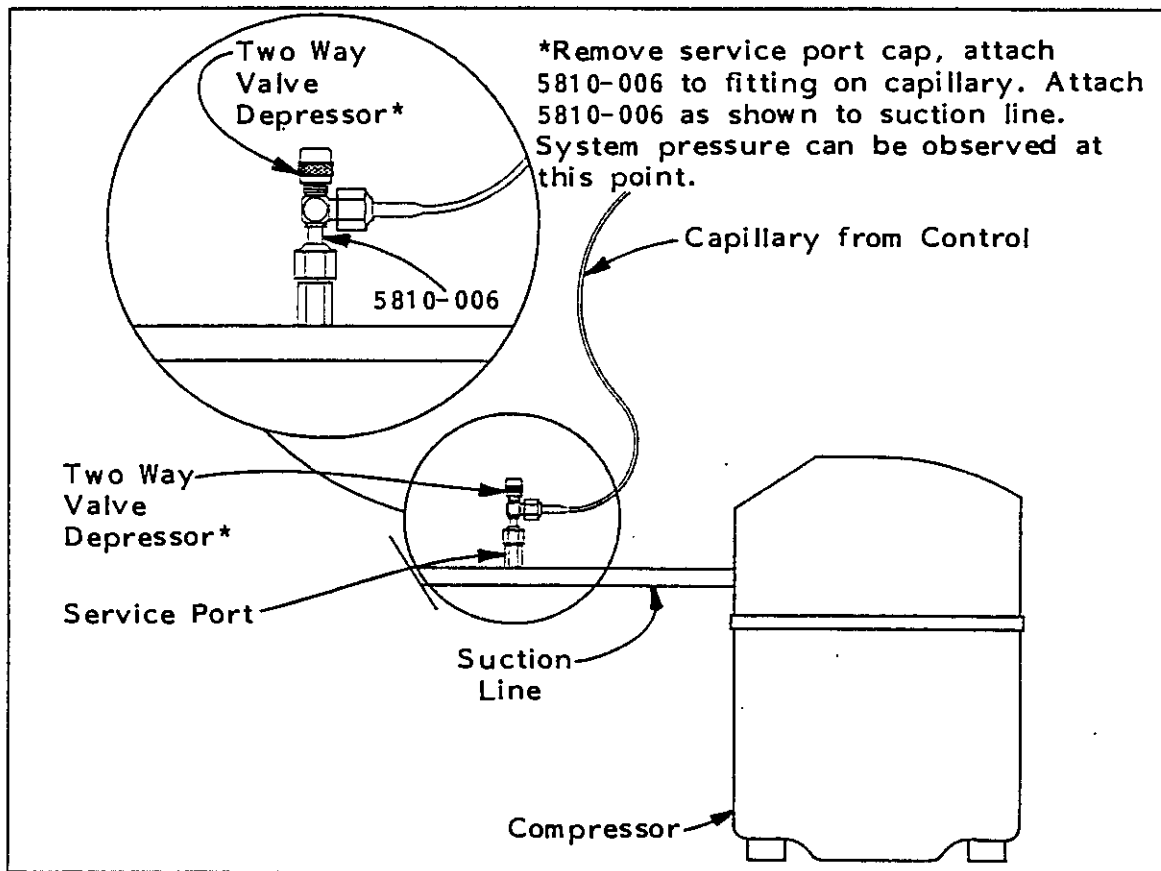

CGA-3
DUAL PRESSURE CONTROL
FOR AIR CONDITIONERS

During operation of the air conditioner the unit will shut off when the system low pressure drops below the set value of the control (factory set at 40 psig) or if the high pressure exceeds the set value of the control (factory set at 425 psig). In either case the unit will not resume operation until the control is reset by pushing the manual reset button located on the top of the control.

NOTE: Cut-out settings are adjustable if necessary to match specific installation requirements.

CAPILLARY TUBE CONNECTION

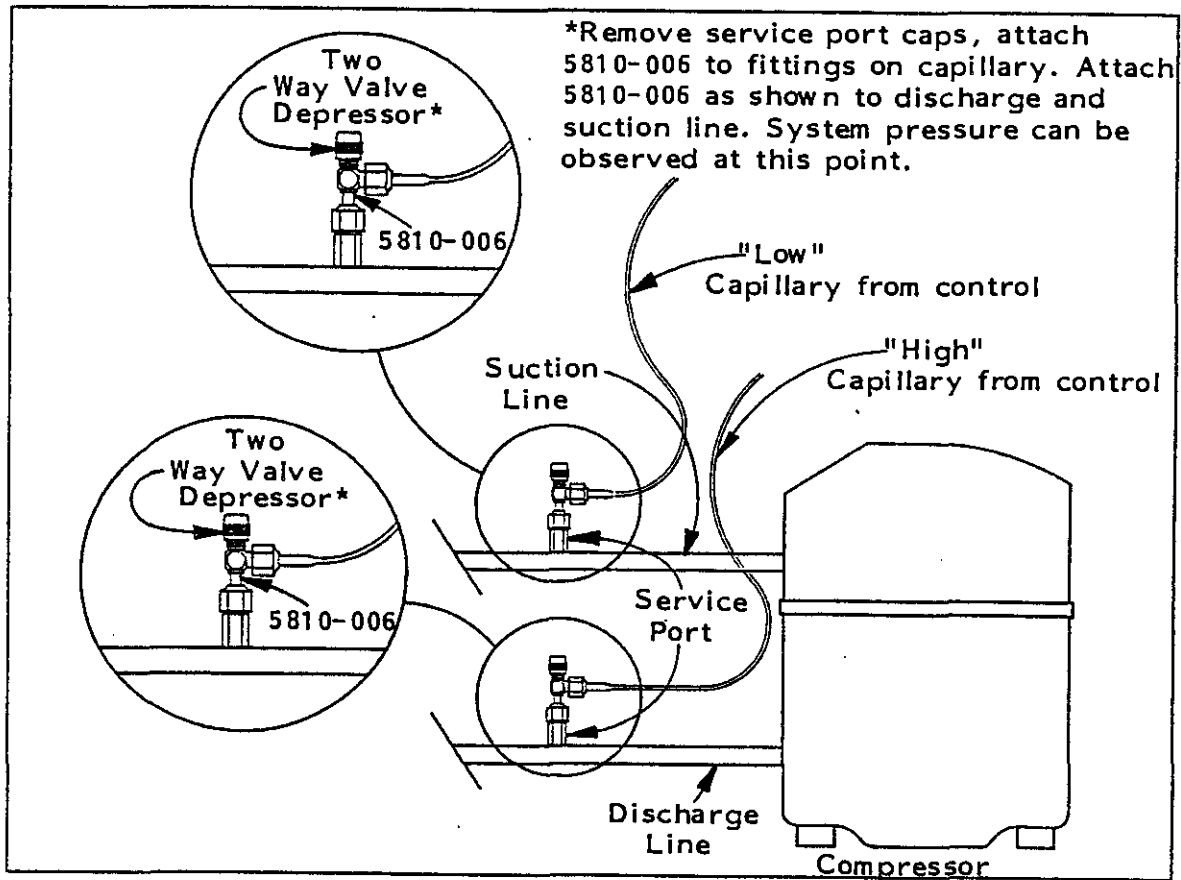

CGA-5
LOW AMBIENT CONTROL
FOR AIR CONDITIONERS

During operation of the air conditioning unit the fan motor will stop when the system high pressure drops to 200 psig. When the system high pressure raises to 300 psig the motor will start and continue to run.

The fan motor will stop and start only when required by the air conditioning unit in order to maintain a uniform system balance between the high and low side.

Cut-in Pressure Setting. 300 psig

Differential Pressure Setting. 100 psig

(This equals 200 psig cut-out pressure. Cut-out is cut-in less differential)

NOTE: Cut-in and cut-out settings are adjustable if necessary to match specific installation requirements.

CAPILLARY TUBE CONNECTION

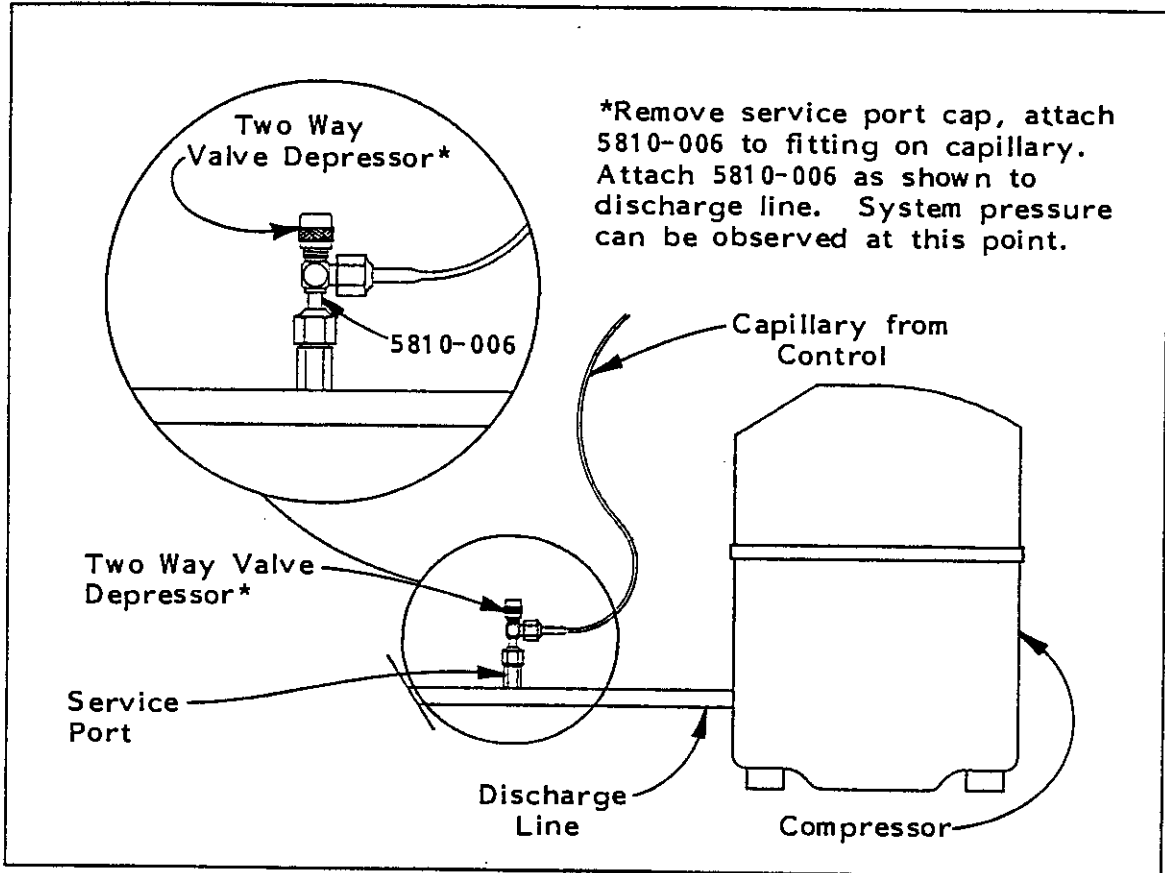

CGH-6
LOW AMBIENT CONTROL
FOR HEAT PUMPS

During the operation of the heat pump unit the fan motor will stop when the system high pressure drops to 200 psig. When the system high pressure raises to 300 psig the motor will start and continue to run.

The fan motor will stop and start only when required by the heat pump in order to maintain a uniform system balance between the high and low side.

Cut-in Pressure Setting. 300 psig

Differential Pressure Setting. 100 psig

(This equals 200 psig cut-out pressure. Cut-out is cut-in less differential)

NOTE: Cut-in and cut-out settings are adjustable if necessary to match specific installation

CAPILLARY TUBE CONNECTION

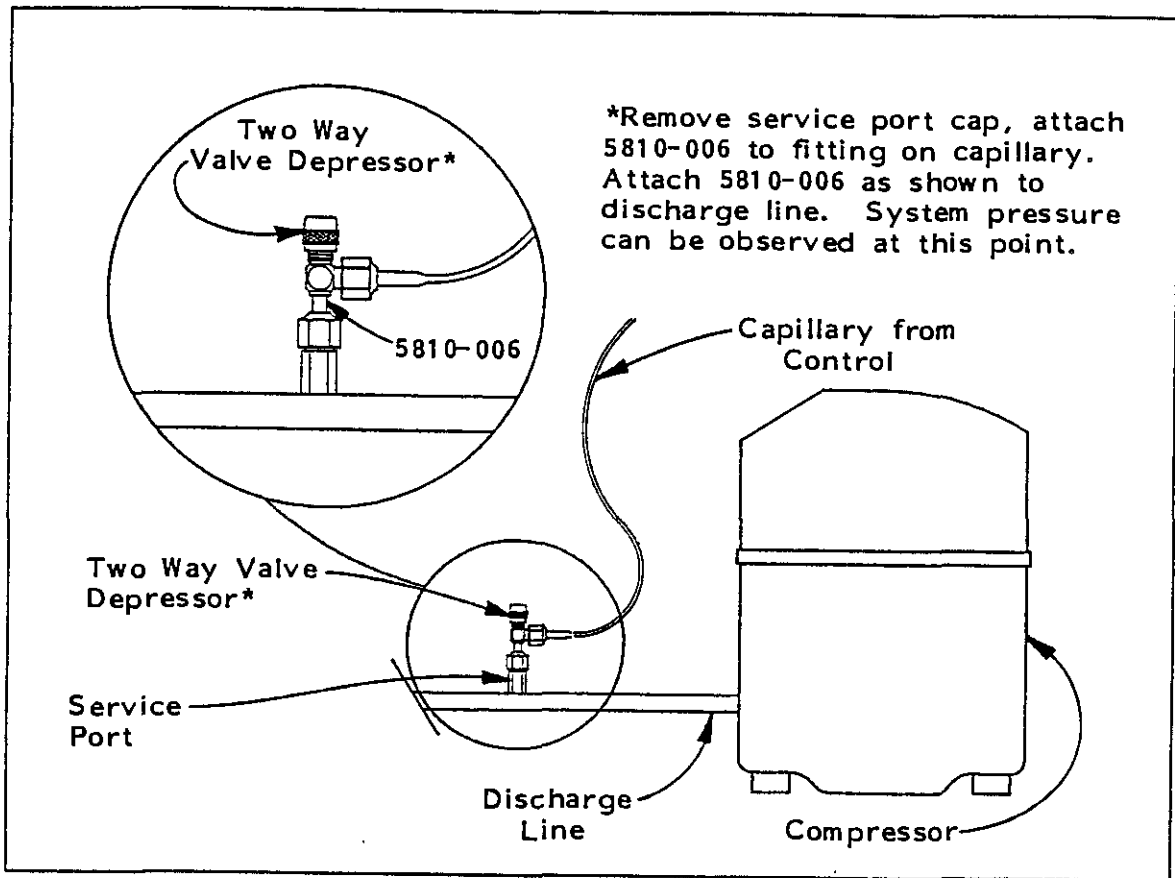

CGA-7
HIGH PRESSURE CONTROL AND TIME DELAY RELAY
FOR AIR CONDITIONERS

HIGH PRESSURE CONTROL

During operation of the air conditioner the unit will shut off when the system high pressure exceeds the set value of the control (factory set at 425 psig) and will not resume operation until the control is reset by pushing the manual reset button located on the top of the control.

NOTE: Cut-out setting is adjusted if necessary to match specific installation requirements.

CAPILLARY TUBE CONNECTION

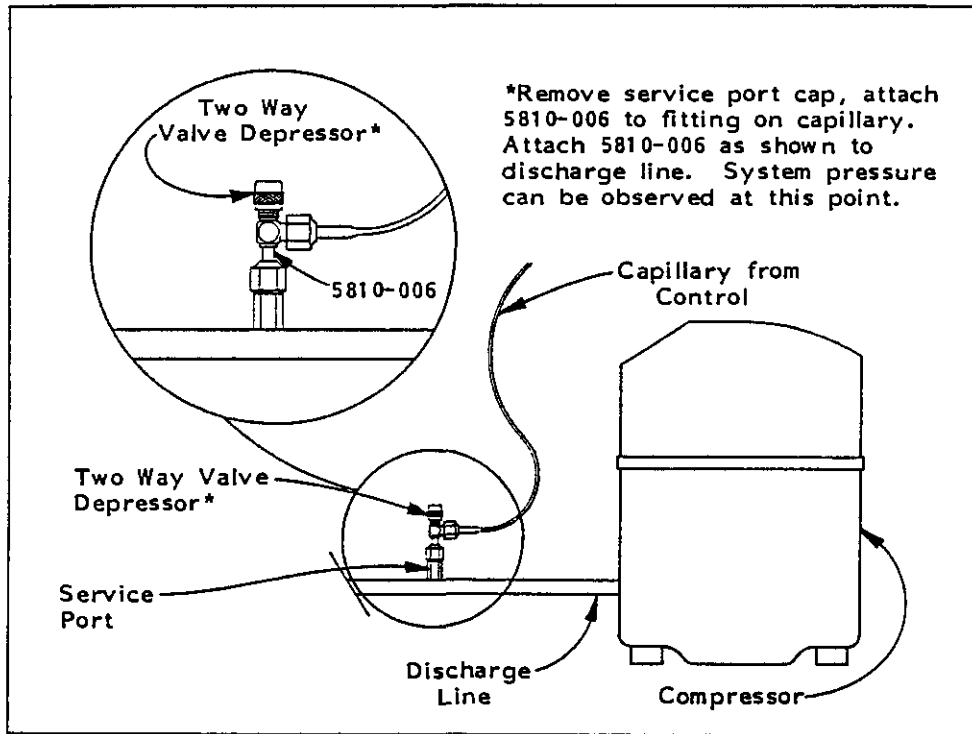

TIME DELAY RELAY

The time delay relay is a time delay device which will hold off the compressor contactor for a fixed time cycle of five minutes.

The application of such a device to an air conditioner or heat pump system is sometimes required because of repeated short-cycling of the equipment caused by "thermostat jiggling" or momentary power outages which occur quite frequently in some parts of the country due to weather conditions.

The time delay relay is a solid state device designed to allow the compressor contactor to operate on demand from the wall thermostat under normal conditions. As long as the "off" time of the air conditioner or heat pump system is longer than the delay period of the relay (five minutes), the compressor contactor will operate immediately. Once the contactor has been energized and then cycled off, for whatever reason, the relay will prevent the compressor contactor from operating until the nominal five minute period has elapsed.

CGA-8
HIGH PRESSURE CONTROL AND LOW AMBIENT CONTROL
FOR AIR CONDITIONERS

HIGH PRESSURE CONTROL

During operation of the air conditioner the unit will shut off when the system high pressure exceeds the set value of the control (factory set at 425 psig) and will not resume operation until the control is reset by pushing the manual reset button located on the top of the control.

NOTE: Cut-out setting is adjusted if necessary to match specific installation requirements.

LOW AMBIENT CONTROL

During operation of the air conditioning unit the fan motor will stop when the system high pressure drops to 200 psig. When the system high pressure raises to 300 psig the motor will start and continue to run.

The fan motor will stop and start only when required by the air conditioning unit in order to maintain a uniform system balance between the high and low side.

Cut-in Pressure setting 300 psig

Differential Pressure Setting. 100 psig

(This equals 200 psig cut-out pressure. Cut-out is cut-in less differential)

NOTE: Cut-in and cut-out settings are adjustable if necessary to match specific installation requirements.

CAPILLARY TUBE CONNECTION

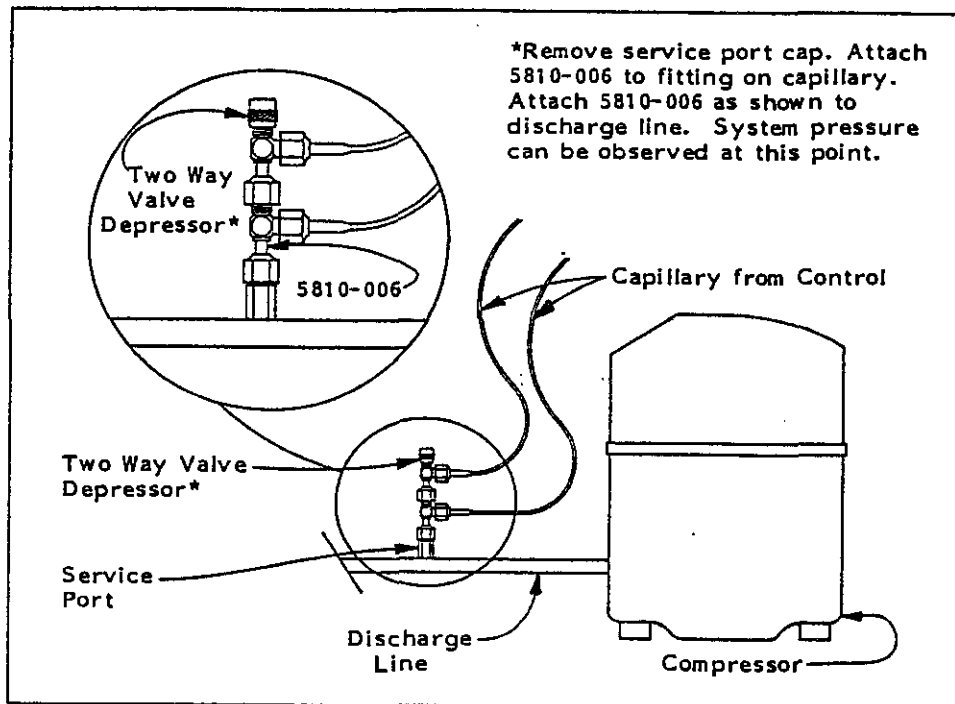

CGAH-9
LOW PRESSURE CONTROL AND TIME DELAY RELAY
FOR AIR CONDITIONERS OR HEAT PUMPS

LOW PRESSURE CONTROL

During operation of the air conditioner or heat pump, the unit will shut off when the system low pressure drops below the set value of the control (factory set at 40 psig for air conditioners, 10 psig for heat pumps) and will not resume operation until the control is reset by pushing the manual reset button located on the top of the control.

NOTE: Cut-out setting is adjustable if necessary to match specific installation requirements.

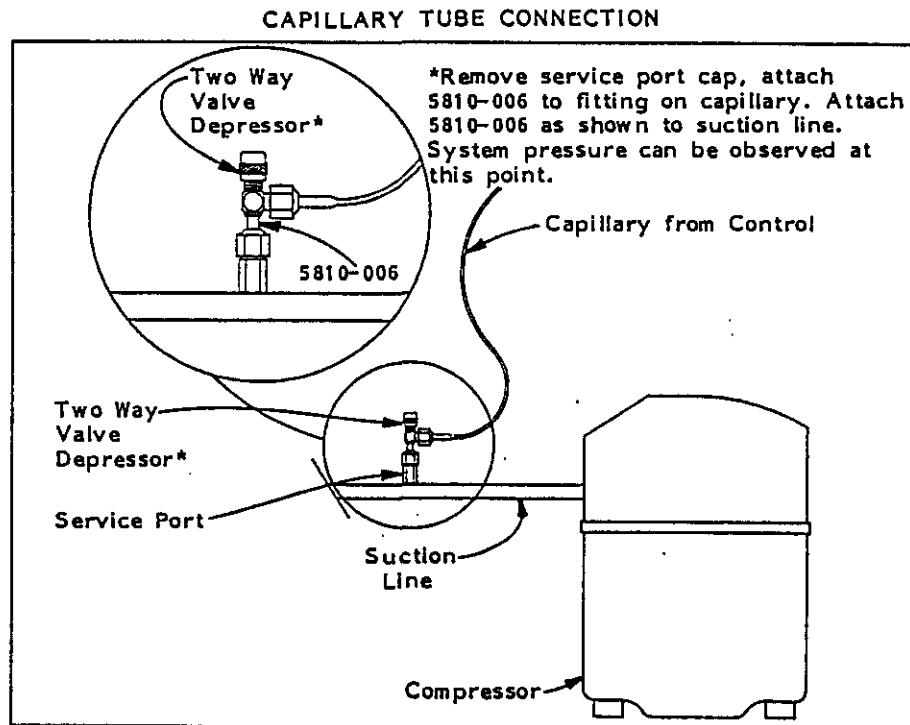

TIME DELAY RELAY

The time delay relay is a time delay device which will hold off the compressor contactor for a fixed time cycle of five minutes.

The application of such a device to an air conditioner or heat pump system is sometimes required because of repeated short-cycling of the equipment caused by "thermostat jiggling" or momentary power outages which occur quite frequently in some parts of the country due to weather conditions.

The time delay relay is a solid state device designed to allow the compressor contactor to operate on demand from the wall thermostat under normal conditions. As long as the "off" time of the air conditioner or heat pump system is longer than the delay period of the relay (five minutes), the compressor contactor will operate immediately. Once the contactor has been energized and then cycled off, for whatever reason, the relay will prevent the compressor contactor from operating until the nominal five minute period has elapsed.

CGA-10
LOW PRESSURE CONTROL AND LOW AMBIENT CONTROL
FOR AIR CONDITIONERS

LOW PRESSURE CONTROL

During operation of the air conditioner the unit will shut off when the system low pressure drops below the set value of the control (factory set at 40 psig for air conditioners) and will not resume operation until the control is reset by pushing the manual reset button located on the top of the control.

NOTE: Cut-out setting is adjustable if necessary to match specific installation requirements.

LOW AMBIENT CONTROL

During operation of the air conditioning unit the fan motor will stop when the system high pressure drops to 200 psig. When the system high pressure raises to 300 psig the motor will start and continue to run.

The fan motor will stop and start only when required by the air conditioning unit in order to maintain a uniform system balance between the high and low side.

Cut-in Pressure setting 300 psig

Differential Pressure Setting. 100 psig

(This equals 200 psig cut-out pressure. Cut-out is cut-in less differential)

NOTE: Cut-in and cut-out settings are adjustable if necessary to match specific installation requirements.

CAPILLARY TUBE CONNECTION

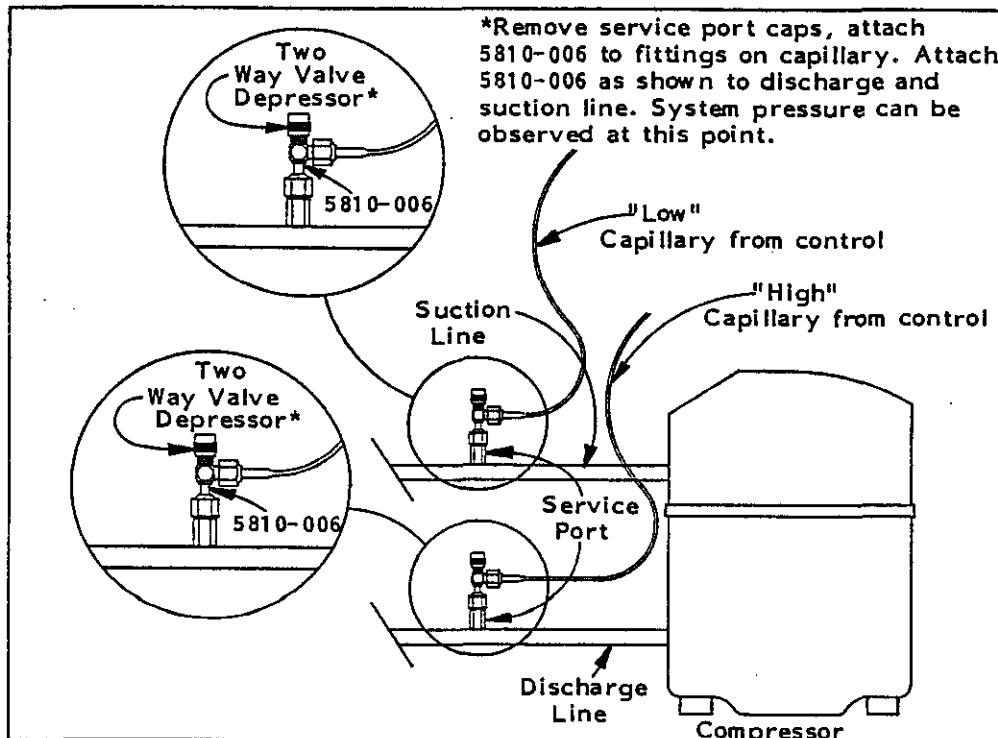

CGH-11
 LOW PRESSURE CONTROL AND LOW AMBIENT CONTROL
 FOR HEAT PUMPS

LOW PRESSURE CONTROL

During operation of the heat pump the unit will shut off when the system low pressure drops below the set value of the control (factory set at 10 psig for heat pumps) and will not resume operation until the control is reset by pushing the manual reset button located on the top of the control.

NOTE: Cut-out setting is adjustable if necessary to match specific installation requirements.

LOW AMBIENT CONTROL

During operation of the heat pump unit the fan motor will stop when the system high pressure drops to 200 psig. When the system high pressure raises to 300 psig the motor will start and continue to run.

The fan motor will stop and start only when required by the heat pump unit in order to maintain a uniform system balance between the high and low side.

Cut-in Pressure setting 300 psig

Differential Pressure Setting. 100 psig

(This equals 200 psig cut-out pressure. Cut-out is cut-in less differential)

NOTE: Cut-in and cut-out settings are adjustable if necessary to match specific installation requirements.

CAPILLARY TUBE CONNECTION

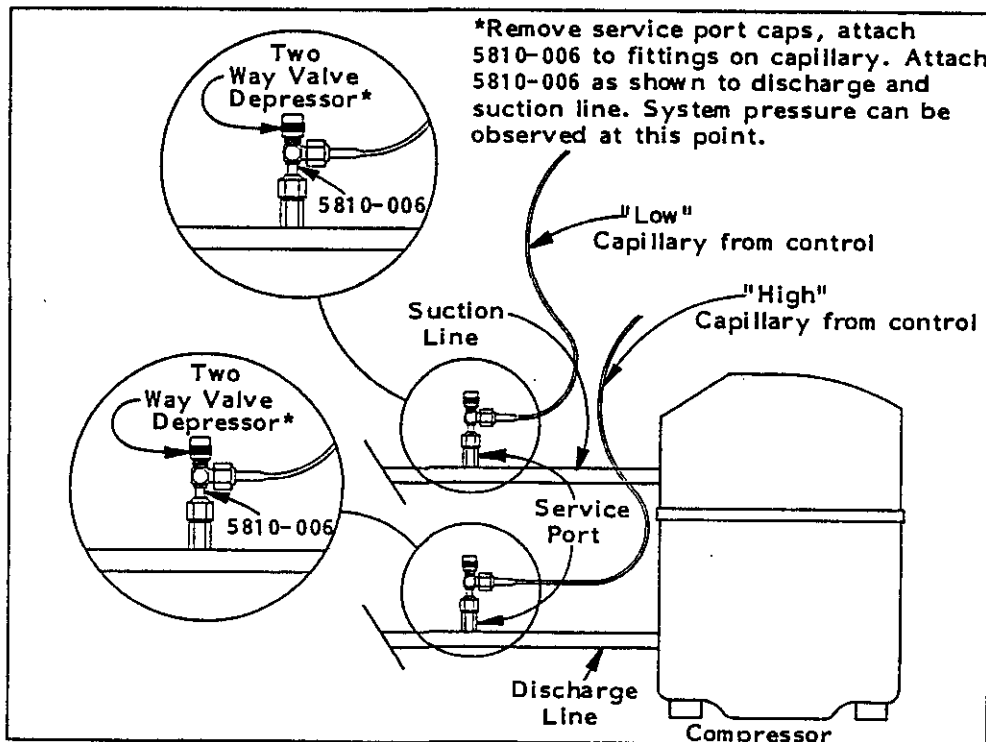

CGA-12
LOW PRESSURE CONTROL, LOW AMBIENT CONTROL,
AND TIME DELAY RELAY FOR AIR CONDITIONERS

LOW PRESSURE CONTROL

During operation of the air conditioner the unit will shut off when the system low pressure drops below the set value of the control (factory set at 40 psig for air conditioners), and will not resume operation until the control is reset by pushing the manual reset button located on the top of the control.

NOTE: Cut-out setting is adjustable if necessary to match specific installation requirements.

LOW AMBIENT CONTROL

During operation of the air conditioning unit the fan motor will stop when the system high pressure drops to 200 psig. When the system high pressure raises to 300 psig the motor will start and continue to run.

The fan motor will stop and start only when required by the heat pump unit in order to maintain a uniform system balance between the high and low side.

Cut-in Pressure setting 300 psig

Differential Pressure Setting. 100 psig

(This equals 200 psig cut-out pressure. Cut-out is cut-in less differential)

CAPILLARY TUBE CONNECTION

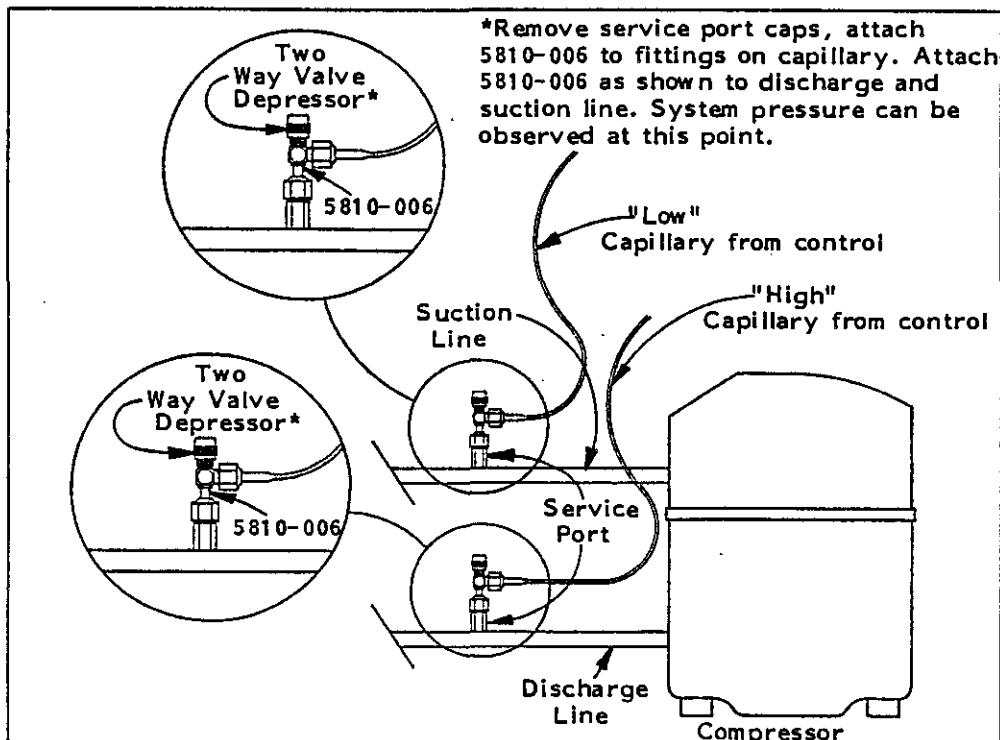

TIME DELAY RELAY

The time delay relay is a time delay device which will hold off the compressor contactor for a fixed time cycle of five minutes.

The application of such a device to an air conditioner or heat pump system is sometimes required because of repeated short-cycling of the equipment caused by "thermostat jiggling" or momentary power outages which occur quite frequently in some parts of the country due to weather conditions.

The time delay relay is a solid state device designed to allow the compressor contactor to operate on demand from the wall thermostat under normal conditions. As long as the "off" time of the air conditioner or heat pump system is longer than the delay period of the relay (five minutes), the compressor contactor will operate immediately. Once the contactor has been energized and then cycled off, for whatever reason, the relay will prevent the compressor contactor from operating until the nominal five minute period has elapsed.

CGH-13
LOW PRESSURE CONTROL, LOW AMBIENT CONTROL,
AND TIME DELAY RELAY FOR HEAT PUMPS

LOW PRESSURE CONTROL

During operation of the heat pump the unit will shut off when the system low pressure drops below the set value of the control (factory set at 10 psig for heat pumps) and will not resume operation until the control is reset by pushing the manual reset button located on the top of the control.

NOTE: Cut-out setting is adjustable if necessary to match specific installation requirements.

LOW AMBIENT CONTROL

During operation of the heat pump unit the fan motor will stop when the system high pressure drops to 200 psig. When the system high pressure raises to 300 psig the motor will start and continue to run.

The fan motor will stop and start only when required by the heat pump unit in order to maintain a uniform system balance between the high and low side.

Cut-in Pressure setting 300 psig

Differential Pressure Setting. 100 psig

(This equals 200 psig cut-out pressure. Cut-out is cut-in less differential)

NOTE: Cut-in and cut-out settings are adjustable if necessary to match specific installation requirements.

CAPILLARY TUBE CONNECTION

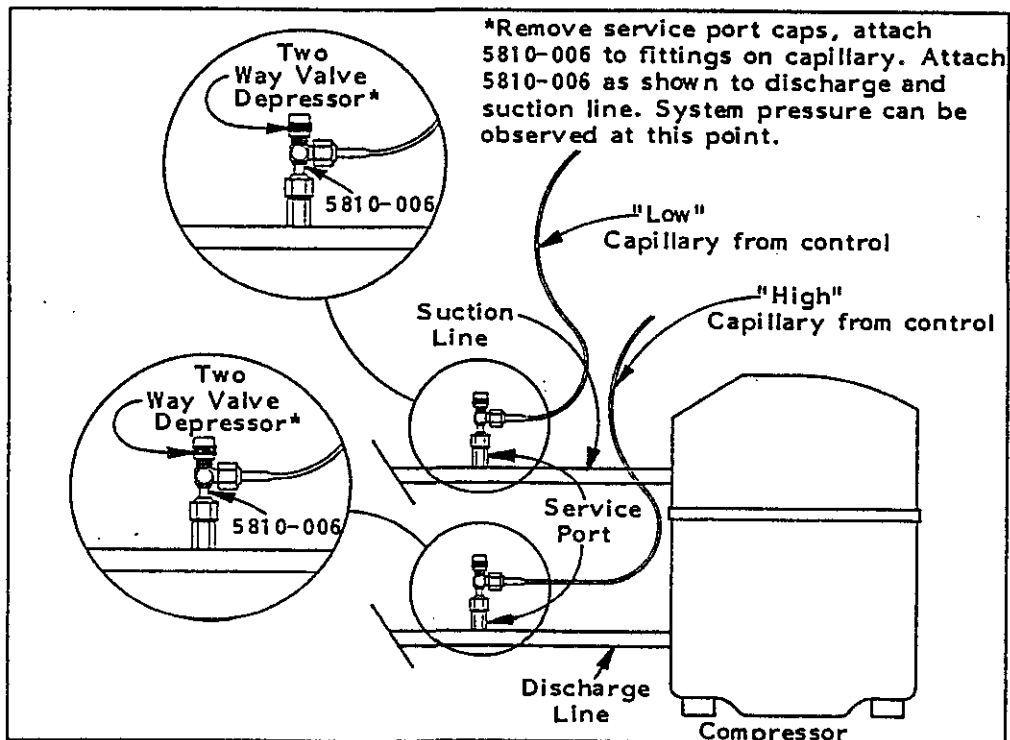

TIME DELAY RELAY

The time delay relay is a time delay device which will hold off the compressor contactor for a fixed time cycle of five minutes.

The application of such a device to an air conditioner or heat pump system is sometimes required because of repeated short-cycling of the equipment caused by "thermostat jiggling" or momentary power outages which occur quite frequently in some parts of the country due to weather conditions.

The time delay relay is a solid state device designed to allow the compressor contactor to operate on demand from the wall thermostat under normal conditions. As long as the "off" time of the air conditioner or heat pump system is longer than the delay period of the relay (five minutes), the compressor contactor will operate immediately. Once the contactor has been energized and then cycled off, for whatever reason, the relay will prevent the compressor contactor from operating until the nominal five minute period has elapsed.

CGA-14
DUAL PRESSURE CONTROL AND TIME DELAY RELAY
FOR AIR CONDITIONERS

DUAL PRESSURE CONTROL

During operation of the air conditioner the unit will shut off when the system low pressure drops below the set value of the control (factory set at 40 psig) or if the high pressure exceeds the set value of the control (factory set at 425 psig). In either case the unit will not resume operation until the control is reset by pushing the manual reset button located on the top of the control.

NOTE: Cut-out settings are adjustable if necessary to match specific installation requirements.

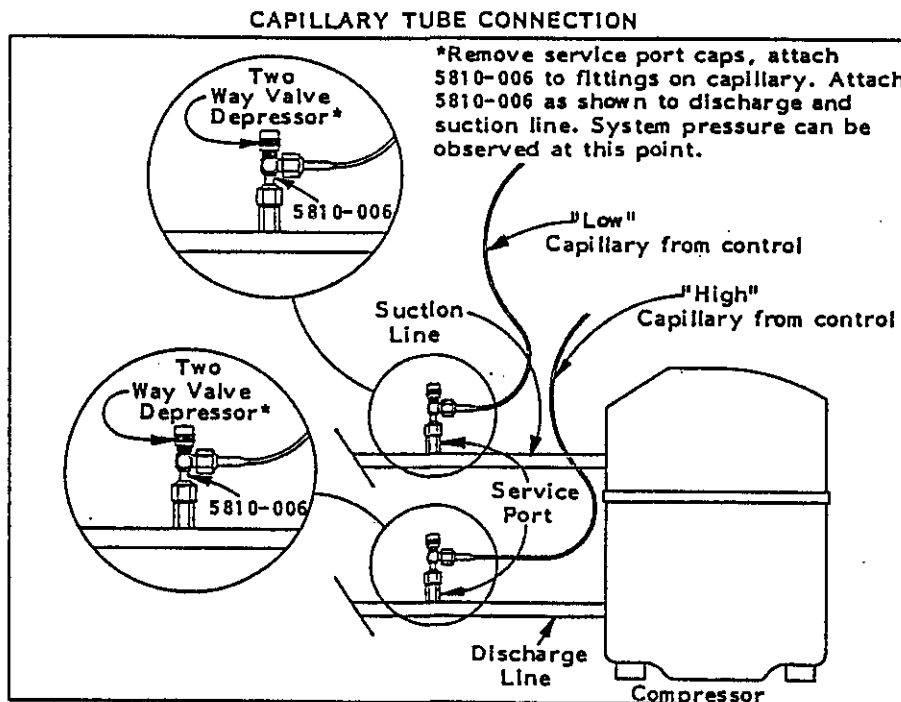

TIME DELAY RELAY

The time delay relay is a time delay device which will hold off the compressor contactor for a fixed time cycle of five minutes.

The application of such a device to an air conditioner or heat pump system is sometimes required because of repeated short-cycling of the equipment caused by "thermostat jiggling" or momentary power outages which occur quite frequently in some parts of the country due to weather conditions.

The time delay relay is a solid state device designed to allow the compressor contactor to operate on demand from the wall thermostat under normal conditions. As long as the "off" time of the air conditioner or heat pump system is longer than the delay period of the relay (five minutes), the compressor contactor will operate immediately. Once the contactor has been energized and then cycled off, for whatever reason, the relay will prevent the compressor contactor from operating until the nominal five minute period has elapsed.

CGA-15
DUAL PRESSURE CONTROL AND LOW AMBIENT CONTROL
FOR AIR CONDITIONERS

DUAL PRESSURE CONTROL

During operation of the air conditioner the unit will shut off when the system low pressure drops below the set value of the control (factory set at 40 psig) or if the high pressure exceeds the set value of the control (factory set at 425 psig). In either case the unit will not resume operation until the control is reset by pushing the manual reset button located on the top of the control.

NOTE: Cut-out settings are adjustable if necessary to match specific installation requirements.

LOW AMBIENT CONTROL

During operation of the air conditioning unit the fan motor will stop when the system high pressure drops to 200 psig. When the system high pressure raises to 300 psig the motor will start and continue to run.

The fan motor will stop and start only when required by the air conditioning unit in order to maintain a uniform system balance between the high and low side.

Cut-in Pressure setting 300 psig

Differential Pressure Setting. 100 psig

(This equals 200 psig cut-out pressure. Cut-out is cut-in less differential)

NOTE: Cut-in and cut-out settings are adjustable if necessary to match specific installation requirements.

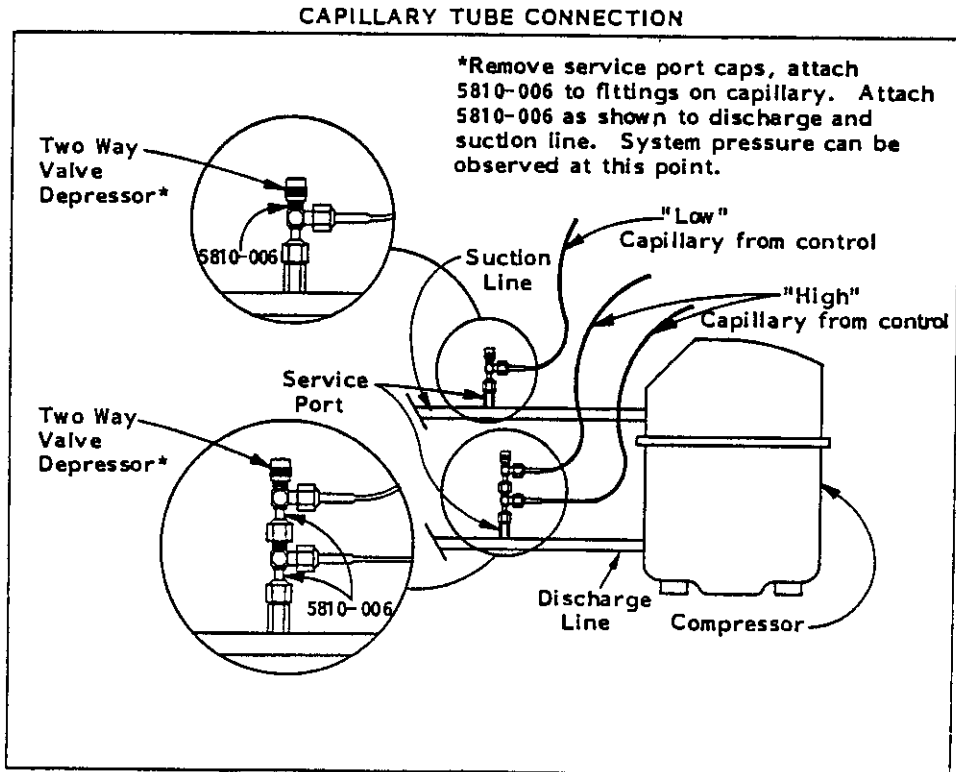

CGA-16
**DUAL PRESSURE CONTROL, LOW AMBIENT CONTROL
 AND TIME DELAY RELAY FOR AIR CONDITIONERS**

DUAL PRESSURE CONTROL

During operation of the air conditioner the unit will shut off when the system low pressure drops below the set value of the control (factory set at 40 psig) or if the high pressure exceeds the set value of the control (factory set at 425 psig). In either case the unit will not resume operation until the control is reset by pushing the manual reset button located on the top of the control.

NOTE: Cut-out settings are adjustable if necessary to match specific installation requirements.

LOW AMBIENT CONTROL

During operation of the air conditioning unit the fan motor will stop when the system high pressure drops to 200 psig. When the system high pressure raises to 300 psig the motor will start and continue to run.

The fan motor will stop and start only when required by the air conditioning unit in order to maintain a uniform system balance between the high and low side.

Cut-in Pressure setting 300 psig

Differential Pressure Setting. 100 psig

(This equals 200 psig cut-out pressure. Cut-out is cut-in less differential)

NOTE: Cut-in and cut-out settings are adjustable if necessary to match specific installation requirements.

CAPILLARY TUBE CONNECTION

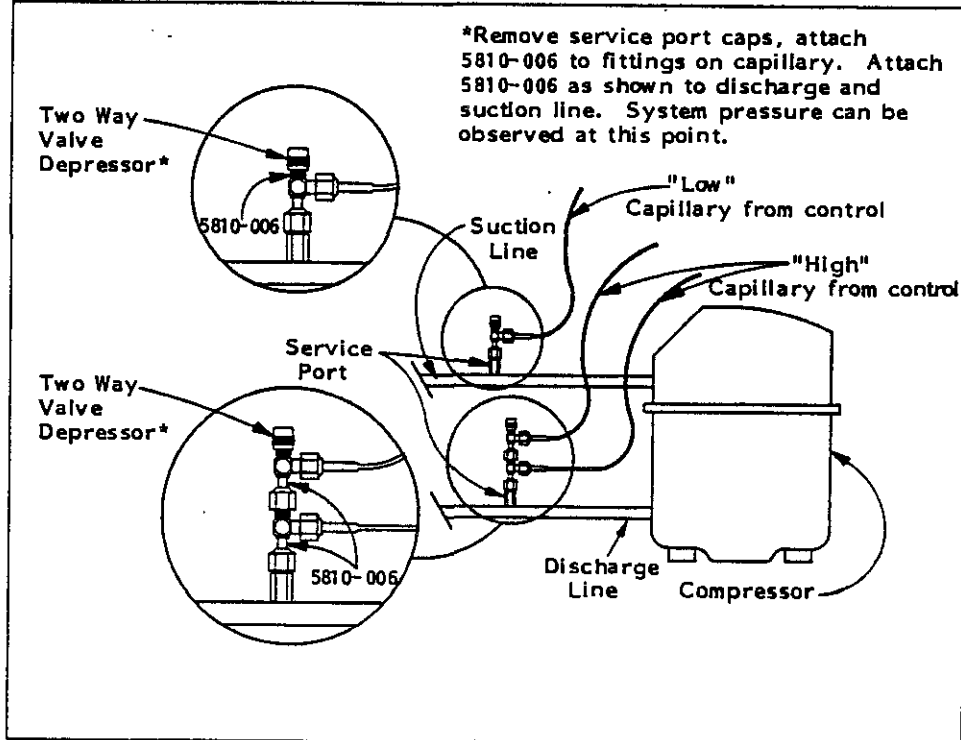

TIME DELAY RELAY

The time delay relay is a time delay device which will hold off the compressor contactor for a fixed time cycle of five minutes.

The application of such a device to an air conditioner or heat pump system is sometimes required because of repeated short-cycling of the equipment caused by "thermostat jiggling" or momentary power outages which occur quite frequently in some parts of the country due to weather conditions.

The time delay relay is a solid state device designed to allow the compressor contactor to operate on demand from the wall thermostat under normal conditions. As long as the "off" time of the air conditioner or heat pump system is longer than the delay period of the relay (five minutes), the compressor contactor will operate immediately. Once the contactor has been energized and then cycled off, for whatever reason, the relay will prevent the compressor contactor from operating until the nominal five minute period has elapsed.

CGA-17
LOW AMBIENT CONTROL AND TIME DELAY RELAY
FOR AIR CONDITIONERS

LOW AMBIENT CONTROL

During operation of the air conditioning unit the fan motor will stop when the system high pressure drops to 200 psig. When the system high pressure raises to 300 psig the motor will start and continue to run.

The fan motor will stop and start only when required by the air conditioning unit in order to maintain a uniform system balance between the high and low side.

Cut-in Pressure setting 300 psig

Differential Pressure Setting. 100 psig

(This equals 200 psig cut-out pressure. Cut-out is cut-in less differential)

NOTE: Cut-in and cut-out settings are adjustable if necessary to match specific installation requirements.

CAPILLARY TUBE CONNECTION

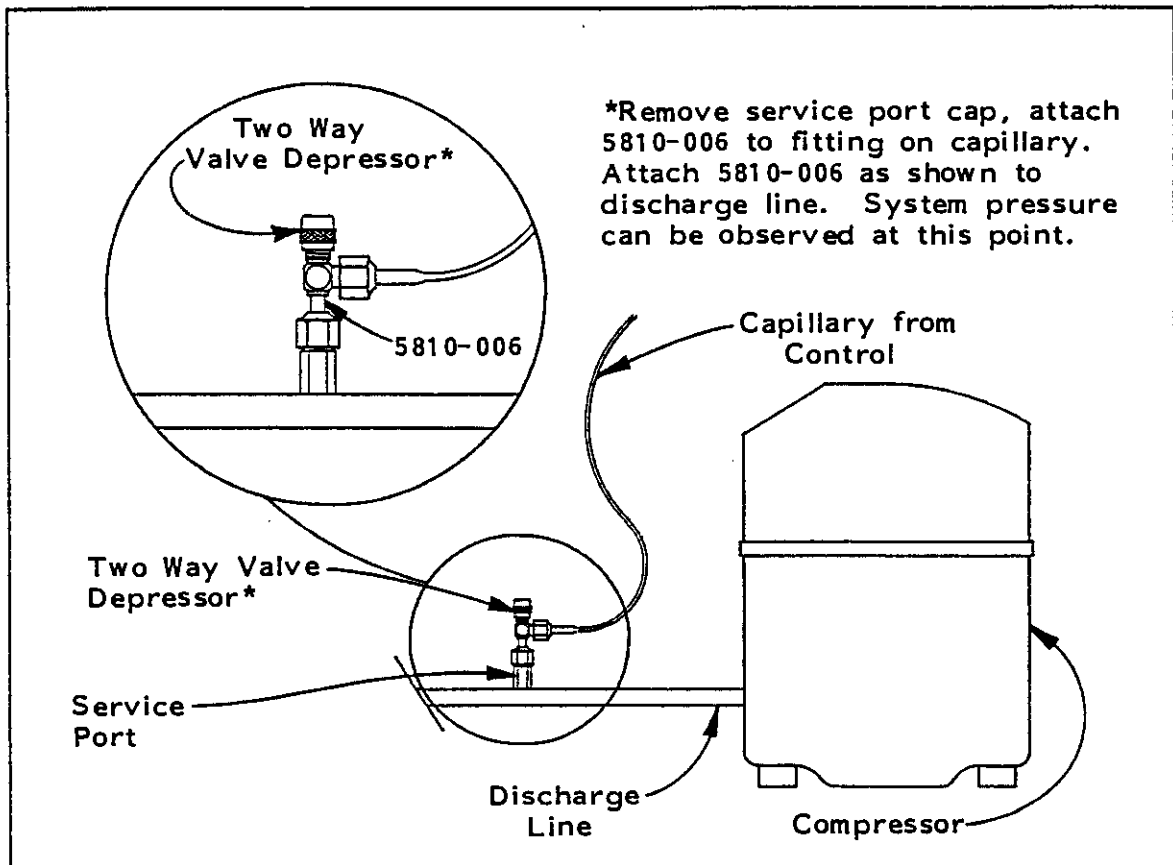

TIME DELAY RELAY

The time delay relay is a time delay device which will hold off the compressor contactor for a fixed time cycle of five minutes.

The application of such a device to an air conditioner or heat pump system is sometimes required because of repeated short-cycling of the equipment caused by "thermostat jiggling" or momentary power outages which occur quite frequently in some parts of the country due to weather conditions.

The time delay relay is a solid state device designed to allow the compressor contactor to operate on demand from the wall thermostat under normal conditions. As long as the "off" time of the air conditioner or heat pump system is longer than the delay period of the relay (five minutes), the compressor contactor will operate immediately. Once the contactor has been energized and then cycled off, for whatever reason, the relay will prevent the compressor contactor from operating until the nominal five minute period has elapsed.

CGH-18
LOW AMBIENT CONTROL AND TIME DELAY RELAY
FOR HEAT PUMPS

LOW AMBIENT CONTROL

During operation of the heat pump unit the fan motor will stop when the system high pressure drops to 200 psig. When the system high pressure raises to 300 psig the motor will start and continue to run.

The fan motor will stop and start only when required by the heat pump unit in order to maintain a uniform system balance between the high and low side.

Cut-in Pressure setting 300 psig

Differential Pressure Setting. 100 psig

(This equals 200 psig cut-out pressure. Cut-out is cut-in less differential)

NOTE: Cut-in and cut-out settings are adjustable if necessary to match specific installation requirements.

CAPILLARY TUBE CONNECTION

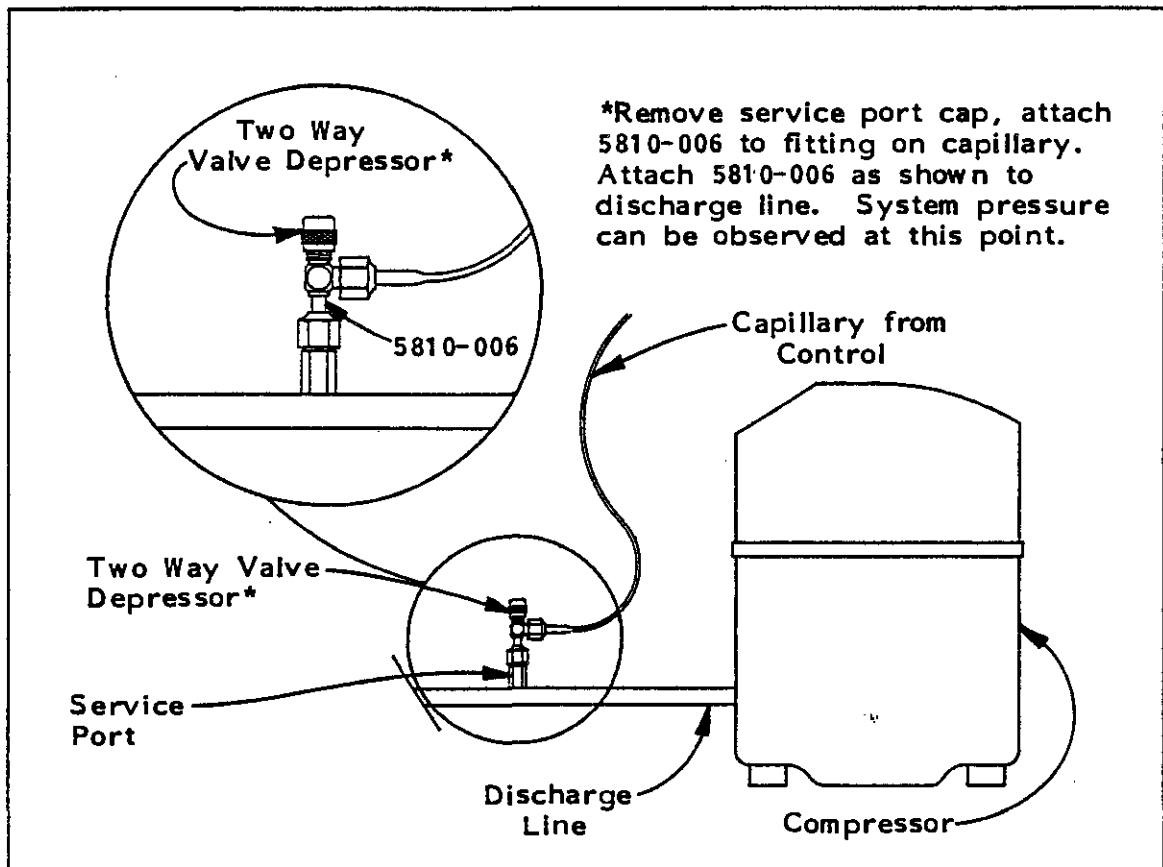

TIME DELAY RELAY

The time delay relay is a time delay device which will hold off the compressor contactor for a fixed time cycle of five minutes.

The application of such a device to an air conditioner or heat pump system is sometimes required because of repeated short-cycling of the equipment caused by "thermostat jiggling" or momentary power outages which occur quite frequently in some parts of the country due to weather conditions.

The time delay relay is a solid state device designed to allow the compressor contactor to operate on demand from the wall thermostat under normal conditions. As long as the "off" time of the air conditioner or heat pump system is longer than the delay period of the relay (five minutes), the compressor contactor will operate immediately. Once the contactor has been energized and then cycled off, for whatever reason, the relay will prevent the compressor contactor from operating until the nominal five minute period has elapsed.

