

INSTALLATION INSTRUCTIONS

SPLIT HEAT PUMP OUTDOOR SECTION

MODELS

**24UHPQA
30UHPQB
36UHPQB**

**FOR USE WITH:
MATCHING INDOOR BLOWER
COIL UNITS AND MATCHING
ADD ON COIL UNITS ONLY**

**MANUAL 2100-153 REV. N
SUPERSEDES REV. M
FILE VOL. I, TAB 5**

COPYRIGHT FEBRUARY, 1989
BARD MANUFACTURING COMPANY
BRYAN, OHIO

TABLE OF CONTENTS

I.	APPLICATION AND LOCATION	3
	General	3
	Shipping Damage	3
	Application	3
	Location	3
	Setting The Unit	3
	Slab Mounting	5
	Roof Mounting	5
	Winter Installation Below 32 Degree F	5
	Indoor Coil	5
	Important Installer Note	5
	Installing Refrigerant Tubing	6
II.	WIRING INSTRUCTIONS	8
	General	8
	Outdoor Thermostat	8
	Crankcase Heaters	9
	General Operation--Heat Pump/Fossil Fuel Furnace	9
	Note On Indoor Blower Operation	9
	Control Circuit Wiring	10
	Sequence of Operation When Used With Indoor Blower Coil	15
	Thermostat Indicator Lamp	16
	Compressor Short Cycle Protection	16
	Defrost Cycle	16
	Solid State Heat Pump Control Troubleshooting Procedure	18
	Checking Temperature Sensor Outside Unit Circuit	19
	Emergency Heat Position	20
III.	CHARGING INSTRUCTIONS	20
	Pressure Service Ports	20
	Refrigerant Charge	20
	Total System Charge For Split Systems	21
IV.	SERVICE	23
	Service Hints	23
	Fan Blade Setting Dimensions	23
	Wiring Diagrams	24
	Pressure Tables	25

FIGURES AND TABLES

Figure 1	1
Figure 2	4
Figure 3	4
Figure 4	4
Figure 5	4
Figure 6	6
Figure 7	8
Figure 8	15
Figure 9	17
Figure 10	23

Table 1	1
Table 2	2
Table 3	2
Table 4	6
Table 4A	10
Table 4B	10
Table 5	16
Table 6	20
Table 7	21
Table 9	22
Table 10	23
Table 11	25
Table 12	25
Table 13	26
Table 14	26
Table 15	27
Table 16	27

FIGURE 1

NOMENCLATURE EXPLANATION--Example:

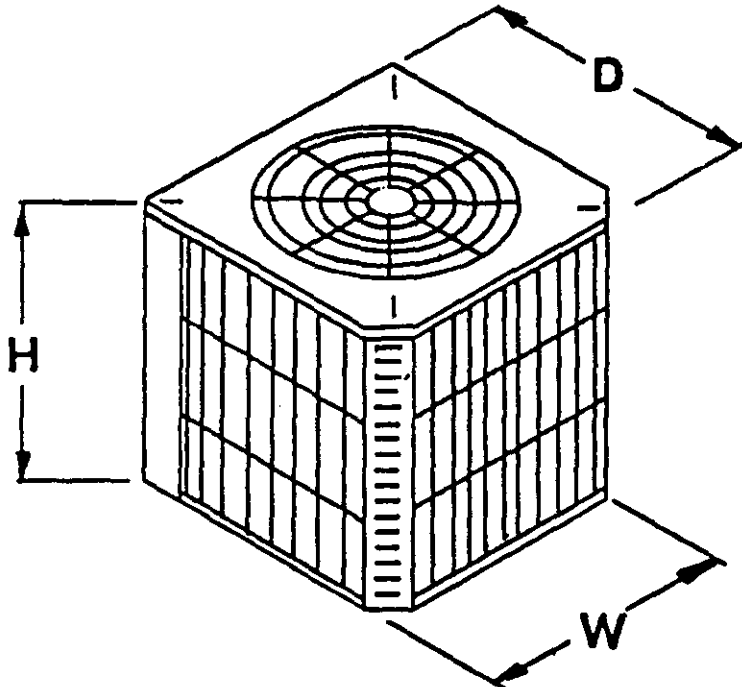
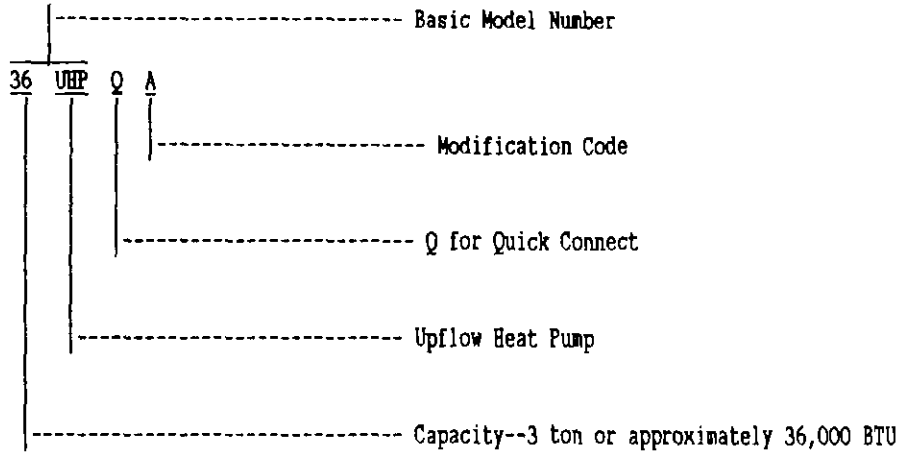

TABLE 1

DIMENSIONS			
Basic Model No.	"W" Width	"D" Depth	"H" Height
24UHPQA			
30UHPQB	32-1/2"	32-1/2"	26"
36UHPQB			

TABLE 2

RATED CFM AND AIRFLOW DATA (Wet Coil--Cooling)							
Condensing Unit Model Number	Evaporator Coil Model Number	Rated AirFlow		Rated E.S.P. (2)	Motor Speed Tap	Recommended Air Flow Range	System Orifice Required
		CFM	Pressure Drop H ₂ O (1)				
24UHPQA	BC24B	800		.35	High	700 - 910	.059
	A30AQ-B	800	.16			700 - 910	.059
	A30AQ-A	800	.16			700 - 910	.059*
30UHPQB	BC36B	1050		.30 (3)	Low	900 - 1150	.067*
	BC35B	975		.50 (3)	Low	825 - 1075	--
	A36AQ,S-A	1050	.20			900 - 1150	.067
	A42AS,S-A	1050	.15			900 - 1150	.067*
	A37AQ-A	1050	.15			900 - 1150	.067*
36UHPQB	BC36B	1200		.30 (3)	High	1020 - 1320	.072
	BC35B	1125		.40 (3)	High	950 - 1240	--
	A36AQ,S-A	1200	.30			1020 - 1320	.072
	A36AQ-B	1200	.30			1020 - 1320	.072*
	A42AS,S-A	1200	.20			1020 - 1320	.072
	A37AQ-A	1200	.20			1020 - 1320	.072

(1) Measured across the evaporator coil assembly, including drain pan.
(2) External static pressure available for the duct system--supply and return. All blower coils have multi-speed motors, and value shows is at the recommended rated speed. Consult specification airflow charts with the blower coil units for complete information at other speeds.
(3) Add .05 ESP for side inlet return with FR6 filter rack.

***IMPORTANT**

Proper sized orifice is not factory installed in indoor section. Proper orifice size is shipped with outdoor unit packaged with its installation instructions for indoor sections listed on this page. The orifice must be replaced with the proper system orifice shown above in Table 2.

TABLE 3 ELECTRICAL DATA

MODEL	24UHPQA	30UHPQB	36UHPQB
Electrical Rating (60HZ/V/PH)	230/208-1		
Operating Voltage Range	197 - 253		
Minimum Circuit Ampacity	17	21.5	24
+Field Wire Size	#12	#10	#10
++Delay Fuse Max. or Ckt. Bkr.	25	30	40
Total Unit Amps 230/208	11.4/13.1	14.5/17.4	16.4/18.6
COMPRESSOR			
Rated Load Amps 230/208	10.3/12.0	13.4/16.3	15.3/17.5
Branch Ckt. Selection Current	12.1	14.8	18
Lock Rotor Amps 230/208	57/57	76/76	83.5/83.5
FAN MOTOR AND COMPRESSOR			
Fan Motor--HP/RPM	1/6 - 825		
Fan Motor--Amps	1.1		
Fan--Dia/CFM	24" - 3000		
+ 60 degree C copper wire size. ++ Maximum time delay fuse or HACR type circuit breaker.			

I. APPLICATION AND LOCATION

GENERAL

These instructions explain the recommended method to install the air cooled remote type outdoor unit, the interconnecting refrigerant tubing and the electrical wiring connections to the unit.

The outdoor units are to be used in conjunction with the matching indoor coils or indoor blower coil for comfort cooling/heating applications as shown in the specification sheet.

These instructions and any instructions packaged with any separate equipment required to make up the entire system should be carefully read before beginning the installation. Note particularly "Connecting Quick-Connect Couplings, Starting Procedure" and any tags and/or labels attached to the equipment.

While these instructions are intended as a general recommended guide, they do not supersede any national and/or local codes in any way. Authorities having jurisdiction should be consulted before the installation is made.

SHIPPING DAMAGE

Upon receipt of equipment, the carton should be checked for external signs of shipping damage. If damage is found, the receiving party must contact the last carrier immediately, preferably in writing, requesting inspection by the carrier's agent.

APPLICATION

Size of unit for a proposed installation should be based on heat loss calculation made according to methods of Air Conditioning Contractors of America. The air duct should be installed in accordance with the Standards of the National Fire Protection Association for the Installation of Air Conditioning and Ventilating Systems of Other Than Residence Type, NFPA No. 90A and Residence Type Warm Air Heating and Air Conditioning Systems, NFPA No. 90B. Where local regulations are at a variance with instructions, installer should adhere to local codes.

For applications in Canada, the installation of the system must be made in accordance with CSA Standards C22.1, Canadian Electrical Code, Part I; C273.5 Installation Requirements for Air-To-Air Heat Pumps; and B52, Mechanical Refrigeration Code.

LOCATION

The outdoor unit is designed to be located outside with free and unobstructed outdoor coil air inlet and discharge. It must also permit access for service and installation. Outdoor air enters the coil on three sides and discharges upward from the top. Refrigerant and electrical connections are made from the rear of the unit as shown in Figure 3 with electrical service access on the right side. The unit can be installed with the rear of the unit "close to the wall", however, additional service clearance at the back of the unit would be desirable if practical for unit service. The compressor can be serviced through the top.

SETTING THE UNIT

GENERAL--The unit must be located outside, or in a well ventilated area. It must not be in the space being heated or cooled. A sound absorbing material should be considered if the unit is to be installed in such a position or location that might cause transmission of sound or vibration to the living area or adjacent buildings.

Figure 2

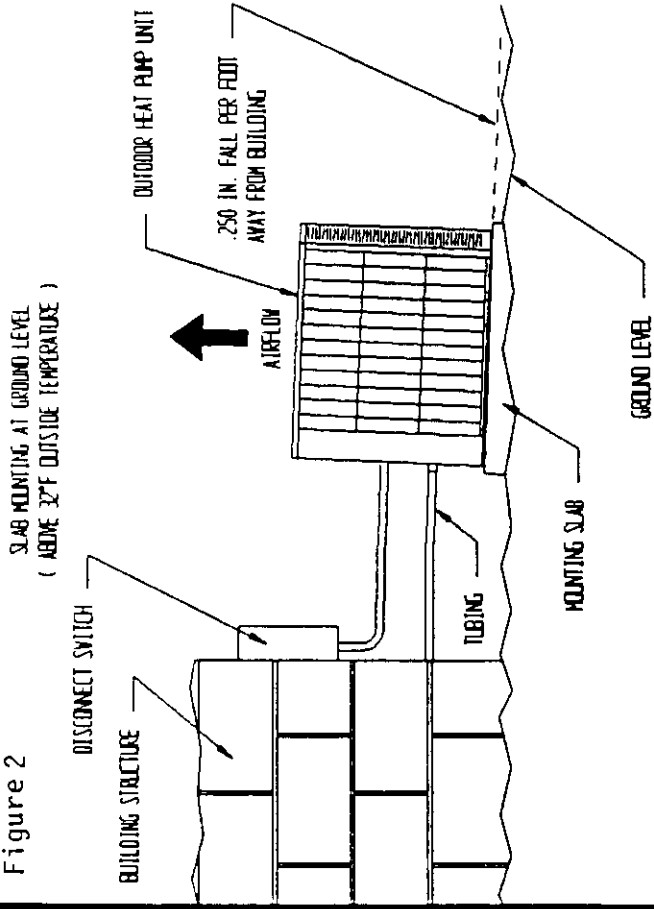

Figure 4

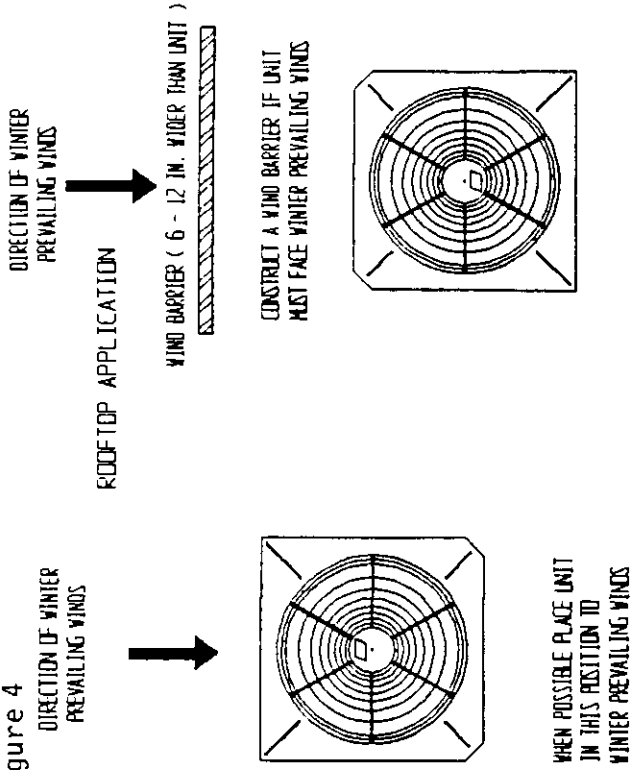

Figure 3

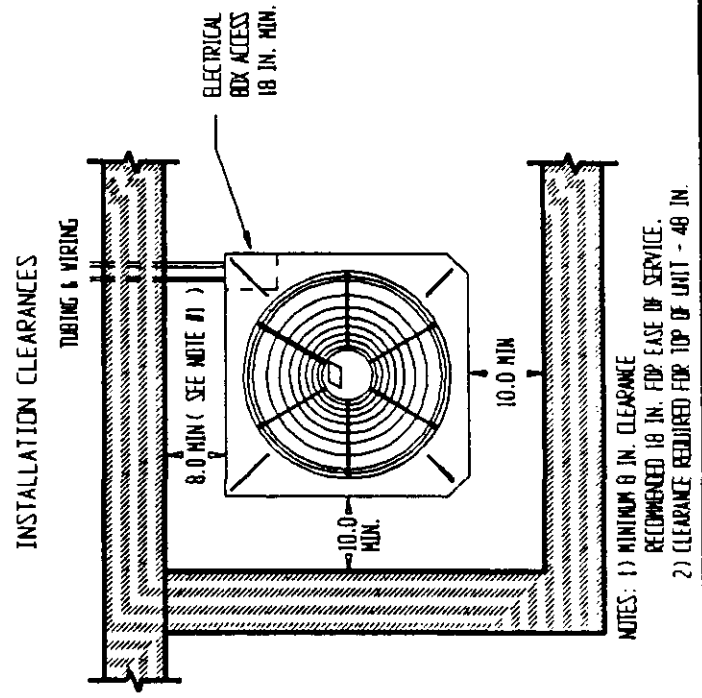
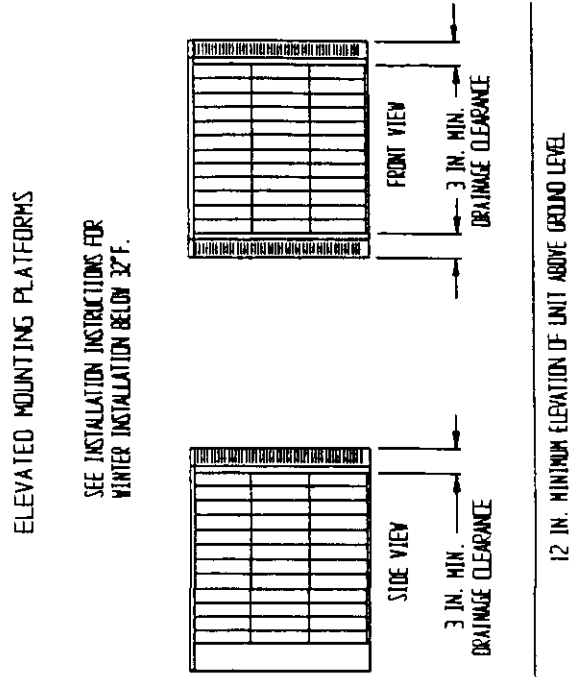

Figure 5



SLAB MOUNTING

In areas where winter temperatures DO NOT go below 32°F for periods over twelve hours, the unit may be slab mounted at grade level. When installing the unit at grade level, install on a concrete slab at least four inches above finished grade level. Slab should have a slope tolerance away from the building structure of at least 1/4 inch per foot, while being level from side to side. This will prevent ice buildup under the unit during defrost cycles. Place slab in a location where run-off water from higher ground will not collect around unit. See Figure 2.

A minimum clearance should be provided between the coil inlet and any building surfaces. Provide at least four feet between coil outlet and any structures. Provide a minimum of 8 inches clearance on the service access side of the unit. Refer to Figure 3.

ROOF MOUNTING

When a unit is installed in areas where low ambient temperatures or strong winter winds exist, it should be placed so prevailing winter winds are not in direct line with the heat pump coil. If this is not possible, a wind barrier should be constructed. Place barrier 24 inches from the coil side of the unit and in the direction of the prevailing winds. Size barrier at least the same height and 6 to 12 inches wider than unit. See Figure 4.

WINTER INSTALLATION BELOW 32°F

In areas where winter conditions go below 32°F for extended periods, the unit must be elevated above the mounting surface to prevent snowfall or defrost ice accumulation from interfering with the operation of the unit. A minimum of twelve inch elevation is recommended, while greater elevation may be required for areas of high snow accumulation. For ease of installation, a heat pump stand is available from Bard. Poured concrete, steel framework, brick, cement block, etc. can be utilized to construct a suitable raised mounting platform. See Figure 5. The mounting platform must provide support on all 5 dimples located on the unit base and must not rest against the unit base.

IMPORTANT INSTALLER NOTE

For improved start-up performance, wash the indoor coil with a dishwasher detergent.

FIGURE 6

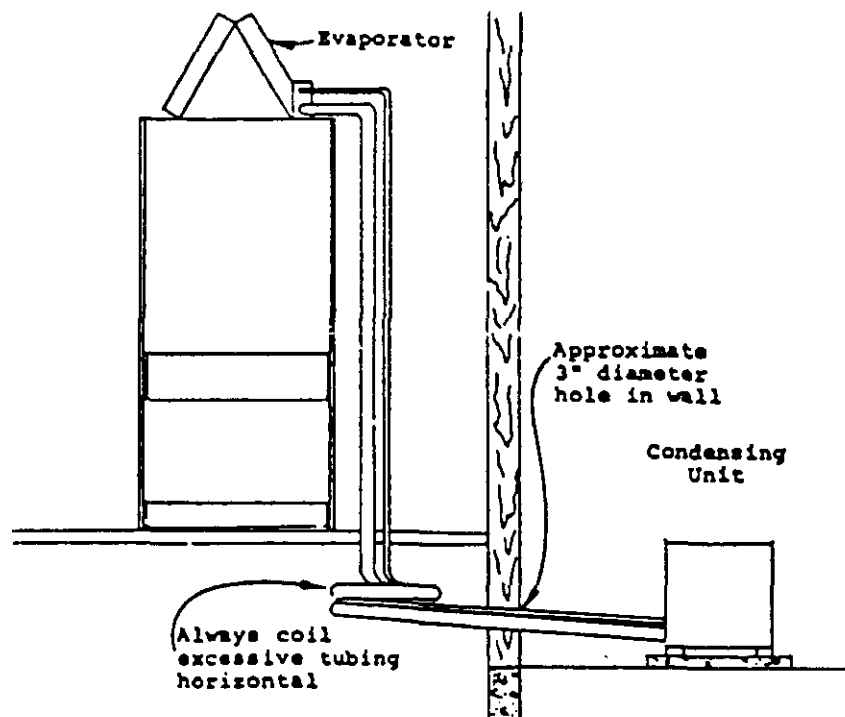

INSTALLING REFRIGERANT TUBING

PRECHARGED TUBING CONNECTIONS (1)

Examine carefully the two lengths of precharged tubing furnished with the system. The larger is the suction line and the smaller is the liquid line. The end of the tubing with the hex nut and gauge port is to be attached to the outdoor unit.

STEP 1--Unroll the tubing, being careful not to kink, and route both the suction line and liquid line between the indoor unit and outdoor unit.

Before fastening either end, use a tubing bender to make any necessary bends in tubing. When necessary to bend the insulated tube suction line, cut the insulation around its circumference at a distance far enough beyond the point of the bend so as to clear the tubing bender. Slip the insulation back together and vapor seal the joint with tape. Coil any excess tubing in a horizontal place with the slope of the tubing toward the condensing unit.

CAUTION: 1. Be careful not to tear the insulation when pushing it through holes in masonry or frame walls. 2. When sealing tube opening in house wall, use a soft material to prevent tube damper and vibration transmission. 3. Avoid excessive bending in any one place to avoid kinking.

STEP 2--Remove protector caps and plugs, inspect fittings and if necessary carefully wipe coupling seats and threaded surfaces with a clean cloth to prevent the inclusion of dirt or any foreign material in the system.

STEP 3--Lubricate male half diaphragm and synthetic rubber seal with refrigerant oil. Starting with the indoor coil thread coupling halves together by hand to insure proper mating of threads. Be sure to hold the coupling firmly to prevent movement of the coupling and tubing. Failure to do so could tear out the diaphragm causing a blockage of the system. Use proper size wrenches (on coupling body hex and on union nut) and tighten until coupling bodies "bottom" or a definite resistance is felt.

CAUTION: After starting to tighten up the fitting, never try to back it off or take it apart.

STEP 4--Using a marker or ink pen, mark a line lengthwise from the coupling union nut to the bulkhead. Then tighten an additional 1/4 turn: The misalignment of the line will show the amount the coupling has been tightened. This final 1/4 turn is necessary to insure the formation of leak proof joint. If a torque wrench is used, the following torque values are recommended:

TABLE 4

Coupling Size	Ft. Lbs.
-6	10 - 12
-10	35 - 45
-11	35 - 45
-12	50 - 65

Repeat Step 3 and 4 on outdoor section making sure to locate the gauge port in a 45° angle from a vertical up position so as to be accessible for gauge connections.

STEP 5--Leak test all connections using an electronic leak detector or a halide torch.

STEP 6--When tubing is installed in attics or drop ceilings, insulate the couplings on the larger tube thoroughly with 3/8" wall thickness, closed cell sponge tube insulation or equivalent. Failure to insulate will result in water damage to ceiling since the fitting will "sweat" and drop water on the ceiling.

(1) **NOTE:** The maximum distance for precharged tubing between the outdoor and indoor unit is 45 feet.

SWEAT STYLE TUBING CONNECTIONS

Use only refrigeration grade (dehydrated and sealed) copper tubing. Care must be taken to insure that the tubing is kept clean and dry before and during installation. Do not remove the plugs from the tubing ends, coil connections or base valves until the connection is ready to be brazed.

The suction line must be insulated with a minimum of 3/8" Armaflex or equivalent before cutting and making connections.

STEP 1--Being careful not to kink, route both the suction line and liquid line between the indoor unit and outdoor unit. Use a tubing bender to make any necessary bends in tubing. When necessary to bend the insulated tube suction line, cut the insulation around its circumference at a distance far enough beyond the point of the bend so as to clear the tubing bender. Slip the insulation back together and vapor seal the joint with tape. Coil any excess tubing in a horizontal place with the slope of the tubing toward the condensing unit.

CAUTION: 1. Be careful not to tear the insulation when pushing it through holes in masonry or frame walls. 2. When sealing tube opening in house wall, use a soft material to prevent tube damage and vibration transmission. 3. Avoid excessive bending in any one place to avoid kinking.

STEP 2--The tubing ends should be cut square. Make sure it is round and free of burrs at the connecting ends. Clean the tubing to prevent contaminants from entering the system.

STEP 3--Wrap a wet rag around the copper stub before brazing.

STEP 4--Flux the copper tube and insert into the stub. Braze the joint using an alloy of silver or copper and phosphorus with a melting temperature above 1100°F for copper to copper joints. The phosphorus will act as a flux, therefore, no flux will be required.

A copper-silver alloy with a high silver content should be used when iron or steel material is involved in the joint. These alloys require the use of silver solder flux. Alloys containing phosphorus should not be used with iron or steel. Phosphorus reacts with the iron, forming iron phosphate which is extremely brittle.

CAUTION: 1. Brazing alloys with a melting temperature below 700°F should not be used. 2. Lead-tin or tin-antimony solders should not be used due to their low melting point and necessity for corrosive fluxes.

To further prevent the formation of copper oxide inside the tubing, dry nitrogen may be purged through the refrigerant system during brazing.

WARNING: Never purge or pressurize a system with oxygen. An explosion and fire will result.

STEP 5--After brazing, quench with wet rag to cool the joint and remove any flux residue.

STEP 6--Leak test all connections using an electronic leak detector or a halide torch.

II. WIRING INSTRUCTIONS

GENERAL

All wiring must be installed in accordance with the National Electrical Code and local codes. In Canada, all wiring must be installed in accordance with the Canadian Electrical Code and in accordance with the regulations of the authorities having jurisdiction. Power supply voltage must conform to the voltage shown on the unit serial plate. A wiring diagram of the unit is attached to the inside of the electrical cover. The power supply shall be sized and fused according to the specifications supplied. A ground lug is supplied in the control compartment for equipment ground.

The control circuit is a 24 volt circuit. "Typical" wiring diagrams illustrating some of the various circuits which could be encountered can be found in the installation instructions of the indoor section.

The unit rating plate lists a "Maximum Time Delay Fuse" or "HACR Type" circuit breaker that is to be used with the equipment. The correct size must be used for proper circuit protection and also to assure that there will be no nuisance tripping due to the momentary high starting current of the compressor motor.

OUTDOOR THERMOSTAT

Heat pump compressor operation at outdoor temperatures below -5°F are neither desirable nor advantageous in terms of efficiency. Since most equipment at time of manufacture is not designated for any specific destination of the country, and most of the equipment is installed in areas not approaching this low outdoor temperature range. An outdoor thermostat (used as a compressor cut-off) is a field installed option.

Outdoor thermostats are available to hold off various stages of electric heat or fossil fuel furnace, until needed as determined by outdoor temperature. The set point of the thermostat(s) is variable with geographic region and sizing of the heating equipment to the structure. Utilization of the Heating Application Data and the heat loss calculation of the building is required in determining the correct set points.

OUTDOOR thermostat WIRING
FIGURE 7

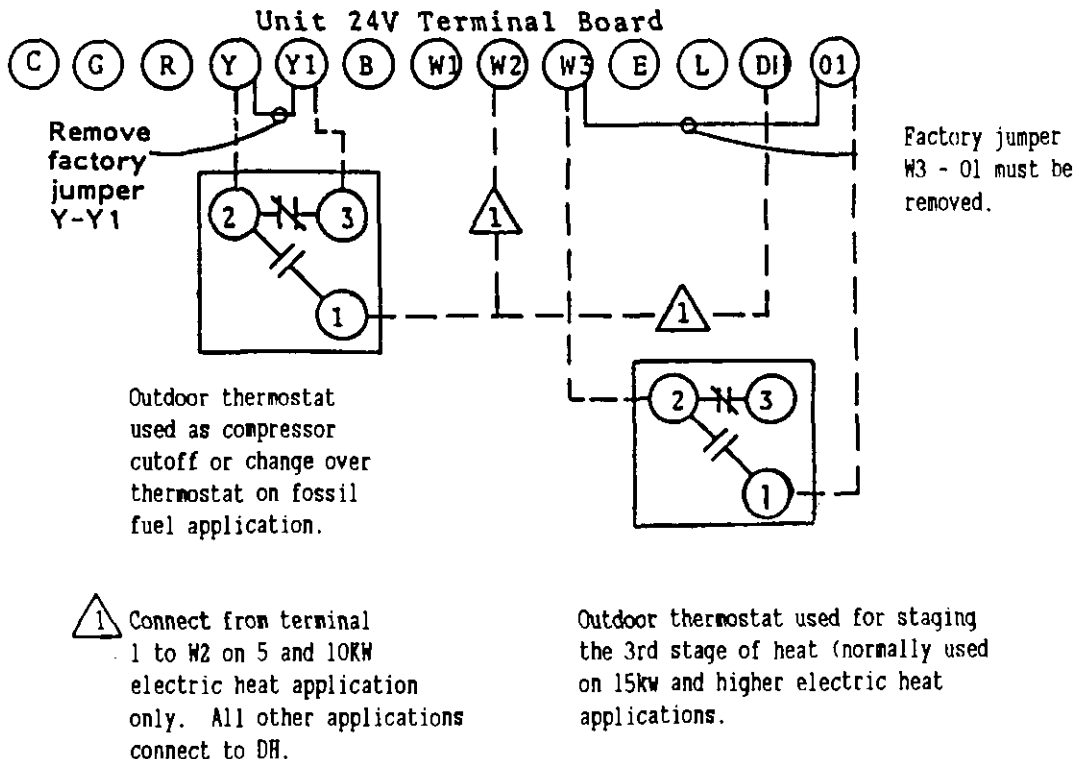

CRANKCASE HEATERS

All models have an insertion well-type heater located in the lower section of the compressor housing. This is a self-regulating type heater that draws only enough power to maintain the compressor at a safe temperature.

Some form of crankcase heat is essential to prevent liquid refrigerant migrating to the compressor causing oil pump out on compressor start-up and possible valve failure due to compressing a liquid.

Refer to unit wiring diagram to find exact type of crankcase heater used.

The following decal is affixed to all outdoor units detailing start-up procedure. This is very important. Please read carefully.

GENERAL OPERATION--HEAT PUMP/FOSSIL FUEL FURNACE

This type of system is a one-stage heating system, even though a two-stage heat wall thermostat is used. The thermostats specified for use are special thermostats for heat pumps with extra switches, signal lights, and special circuitry for heat pumps, and by design are two-stage heating thermostats. Since the extra features are also required for the special heat pump/fossil fuel systems, the same thermostats are used, but the second stage circuit is not used. This is further explained in the next paragraph.

While it would be possible to electrically connect the furnace to the second stage of the thermostat, the heat pump coil is located downstream from the furnace heat exchanger, and continuous simultaneous operation of the furnace and heat pump will result in excessive high discharge pressures and temperatures at the compressor and resultant overload tripping problems. For this reason, the control circuit wiring diagrams shown later in this manual will not allow the furnace to operate except during defrost cycles unless an outdoor thermostat is added to the circuit. The addition of an outdoor thermostat used as a changeover thermostat will switch the system from heat pump heating to furnace heating based on the outdoor temperature. At no time will continuous operation of the heat pump and furnace be allowed.

An outdoor thermostat is used as a changeover thermostat, properly set to control at or just above the balance point, will allow the most economical operation of the system. The changeover (outdoor) thermostat switches off the heat pump and on the fossil fueled furnace, based on the outdoor temperature. There is a 5°F differential in the changeover (outdoor) thermostat, so when the heat pump is de-energized and the furnace is activated, the outdoor temperature must rise 5°F above the setpoint of the thermostat to stop the furnace and start the heat pump again. NOTE: See manual 2100-057 "Heat Pump Sizing" for procedure to determine correct balance point.

The emergency heat switch allows for manual cutoff of the heat pump and operation of the furnace at any outdoor temperature.

NOTE ON INDOOR BLOWER OPERATION

Because of the design of the heat pump wall thermostats and the fact that a cooling blower relay is installed in parallel with the fan side of the combination fan/limit control found on most gas or oil furnaces, the furnace blower will start as soon as the wall thermostat calls for heat. This is required for the heat pump and will also occur during the time when the heat pump is off and the furnace is operating. This is contrary to normal blower operation on a gas or oil furnace and is sometimes misunderstood, but an inherent part of the system operation. While in the gas or oil furnace mode of operation, there will still be a run-on in blower operation until the bonnet temperature cools down to the blower off setting of the fan/limit switch.

CONTROL CIRCUIT WIRING

For split systems, the minimum control circuit wiring gauge needed to insure proper operation of all controls in both indoor and outdoor units will depend on two factors.

1. The rated VA of the control circuit transformer.
2. The maximum total distance of the control circuit wiring. (This is the distance between the wall thermostat to the indoor unit plus the distance between the indoor unit to the outdoor unit.)

The following table should be used to determine proper gauge of control circuit wiring required.

TABLE 4A

Rated VA of Control Circuit Transformer	Transformer Secondary FLA @ 24V	Maximum Total Distance of Control Circuit Wiring In Feet
40	1.6	20 gauge - 65
		18 gauge - 90
		16 gauge - 145
		14 gauge - 230
50	2.1	20 gauge - 45
		18 gauge - 60
		16 gauge - 100
		14 gauge - 160
65	2.7	20 gauge - 40
		18 gauge - 55
		16 gauge - 85
		14 gauge - 135
		12 gauge - 210

Example: 1. Control circuit transformer rated at 40VA.

2. Maximum total distance of control circuit wiring 85 feet.

From the table above, minimum of 18 gauge wire should be used in the control circuit wiring.

For control circuit transformers rated other than those listed, use the next lower rated transformer listed.

Example: 1. Control circuit transformer rated at 55VA.

From table use 50VA transformer.

There are four (4) separate control diagrams for fossil fuel furnaces with heat pump.

TABLE 4B

Heat Pump System	Gas Furnace Control Diagram	Oil Furnace Control Diagram
24UHPQA	4091-200	4091-201
30UHPQB	OR	OR
36UHPQB	4091-808	4091-809

⚠ T874N1024/Q674F1261



T874R1129/Q674L1181

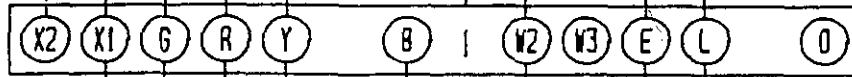

IF58-45

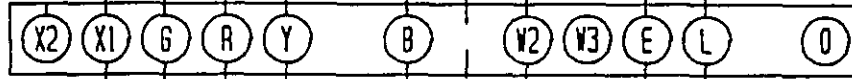

⚠

FAN CENTER 5900-01E005A07
R8325A1057, 175-200101-10
OR ELECTRONIC BLOWER CONTROL
45200, 24V TERMINAL.



⚠ OUTDOOR UNIT
24V TERMINAL

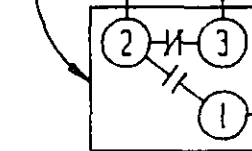

⚠

SET ADJUST HEAT ANTICIPATOR (SEE FURNACE INSTALLATION INSTRUCTIONS)

⚠

WHEN OUTDOOR THERMOSTAT (USED AS CHANGEVER THERMOSTAT) IS INSTALLED, REMOVE JUMPER Y-Y1.

⚠

IF IT DESIRED NOT TO ALLOW FURNACE TO CYCLE 'ON' DURING DEFROST, A 24V FACTORY WIRE RETURN (TERMINAL '3' OF DEFROST RELAY AND TERMINAL '4' ON EMERGENCY HEAT RELAY ON HPQ MODELS OR TERMINAL W2 OF HEATPUMP CONTROL AND TERMINAL OH ON TERMINAL BOARD ON UHP MODELS) MUST BE REMOVED.

HEAT PUMP W/GAS FURNACE

⚠

HPQ SERIES MODEL DO NOT HAVE R TERMINAL AND IT IS NOT REQUIRED TO RUN R WIRE TO THESE MODELS.

⚠

IF THE FURNACE IS NOT INTERNALLY WIRED FOR ADD ON AIR CONDITIONING, A FAN CENTER WILL NEED TO BE ADDED.

	FACTORY WIRING	FIELD WIRING
LOW VOLTAGE	_____	--- ---
HIGH VOLTAGE	_____	--- ---

4091-200 /

⚠ T874N1024/Q674F1261



T874R1129/Q674L1181

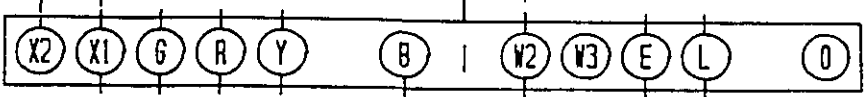

IF58-45

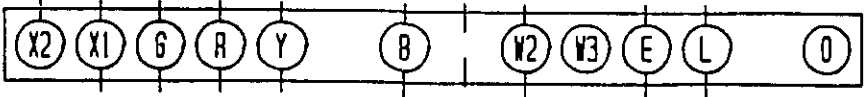

FAN CENTER 5900-01E005A07,
R8325A1057 OR 175-200101-10
24V TERMINAL ⚠

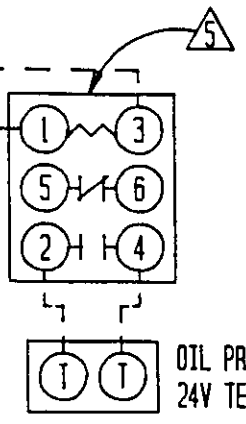
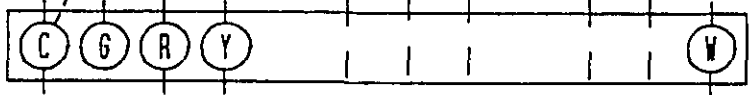

⚠ OUTDOOR UNIT
24V TERMINAL

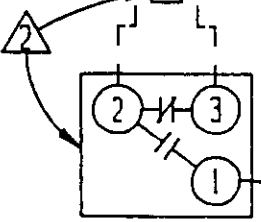
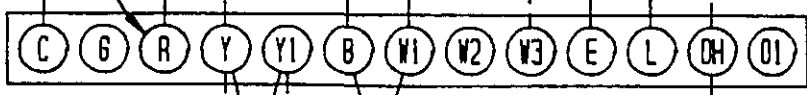

- ⚠ SET ADJUST HEAT ANTICIPATOR (SEE FURNACE INSTALLATION INSTRUCTIONS)
- ⚠ WHEN OUTDOOR THERMOSTAT (USED AS CHANGEDOVER THERMOSTAT) IS INSTALLED, REMOVE JUMPER Y-Y1.
- ⚠ IF IT DESIRED NOT TO ALLOW FURNACE TO CYCLE "ON" DURING DEFROST, A 24V FACTORY WIRE RETURN (TERMINAL "3" OF DEFROST RELAY AND TERMINAL "4" ON EMERGENCY HEAT RELAY ON HPQ MODELS OR TERMINAL W2 OF HEATPUMP CONTROL AND TERMINAL OH ON TERMINAL BOARD ON UHP MODELS) MUST BE REMOVED.

- ⚠ HPQ SERIES MODEL DO NOT HAVE (R) TERMINAL AND IT IS NOT REQUIRED TO RUN (R) WIRE TO THESE MODELS.
- ⚠ LOCATE ISOLATING RELAY IN OIL FURNACE. NECESSARY TO SEPARATE 24V POWER SUPPLY OF HEATPUMP FROM 24V POWER SUPPLY BUILT INTO OIL BURNER PRIMARY CONTROL.
- ⚠ IF THE FURNACE IS NOT INTERNALLY WIRED FOR ADD ON AIR CONDITIONING, A FAN CENTER WILL NEED TO BE ADDED.

	FACTORY WIRING	FIELD WIRING
LOW VOLTAGE	_____	-----
HIGH VOLTAGE	—————	-----

HEAT PUMP W/OIL FURNACE

4091-201 A

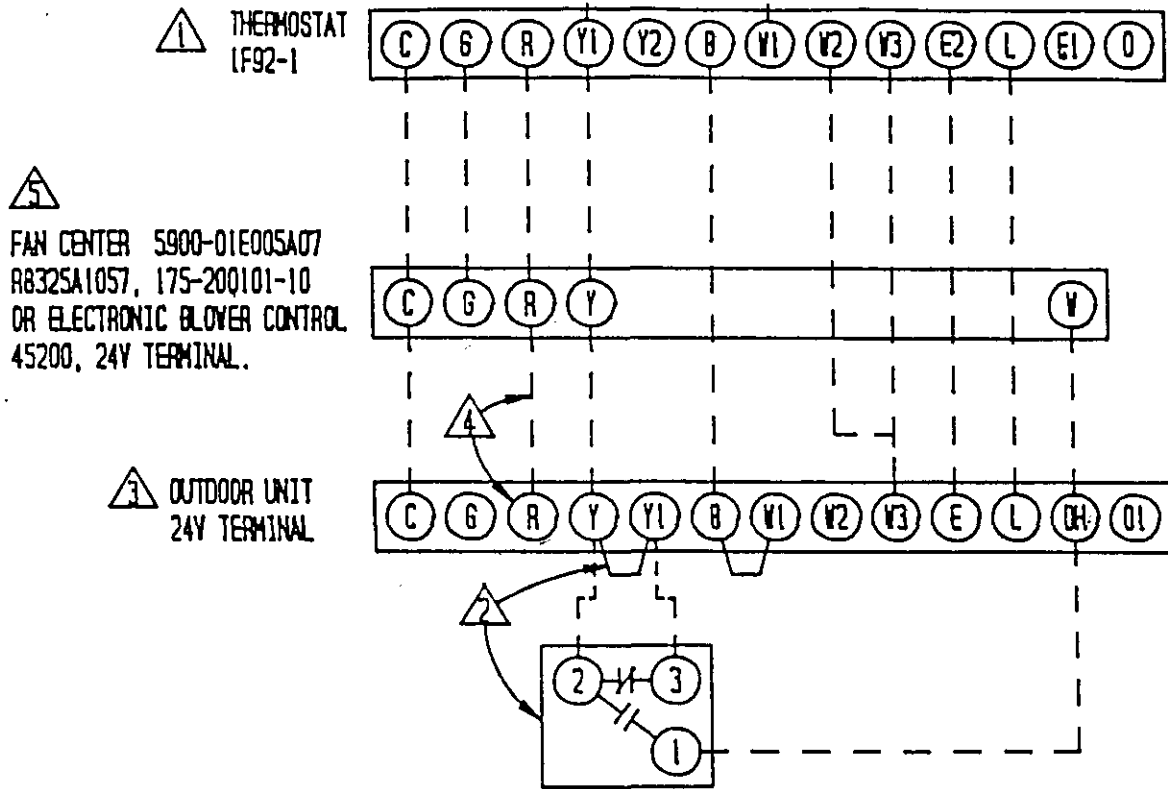

1 OPTION SWITCH SETTING



SWITCH #1 'OFF'
SWITCH #2 'OFF'
SWITCH #3 'OFF'
SWITCH #4 SEE THERMOSTAT
INSTALLATION INSTRUCTIONS

2 WHEN OUTDOOR THERMOSTATE (USED AS CHANGEVER THERMOSTAT) IS INSTALLED, REMOVE JUMPER Y-Y1.

3 IF IT DESIRED NOT TO ALLOW FURNACE TO CYCLE 'ON' DURING DEFROST, A 24V FACTORY WIRE RETURN (TERMINAL '3' OF DEFROST RELAY AND TERMINAL '4' ON EMERGENSEY HEAT RELAY ON HPQ MODELS OR TERMINAL ⑫ OF HEATPUMP CONTROL AND TERMINAL ⑩ ON TERMINAL BOARD ON UHP MODELS) MUST BE REMOVED.

4 HPQ SERIES MODEL DO NOT HAVE ⑧ TERMINAL AND IT IS NOT REQUIRED TO RUN ⑧ WIRE TO THESE MODELS.

5 IF THE FURNACE IS NOT INTERNALLY WIRED FOR ADD ON AIR CONDITIONING, A FAN CENTER WILL NEED TO BE ADDED.

HEAT PUMP W/GAS FURNACE

	FACTORY WIRING	FIELD WIRING
LOW VOLTAGE	_____	----
HIGH VOLTAGE	—————	----

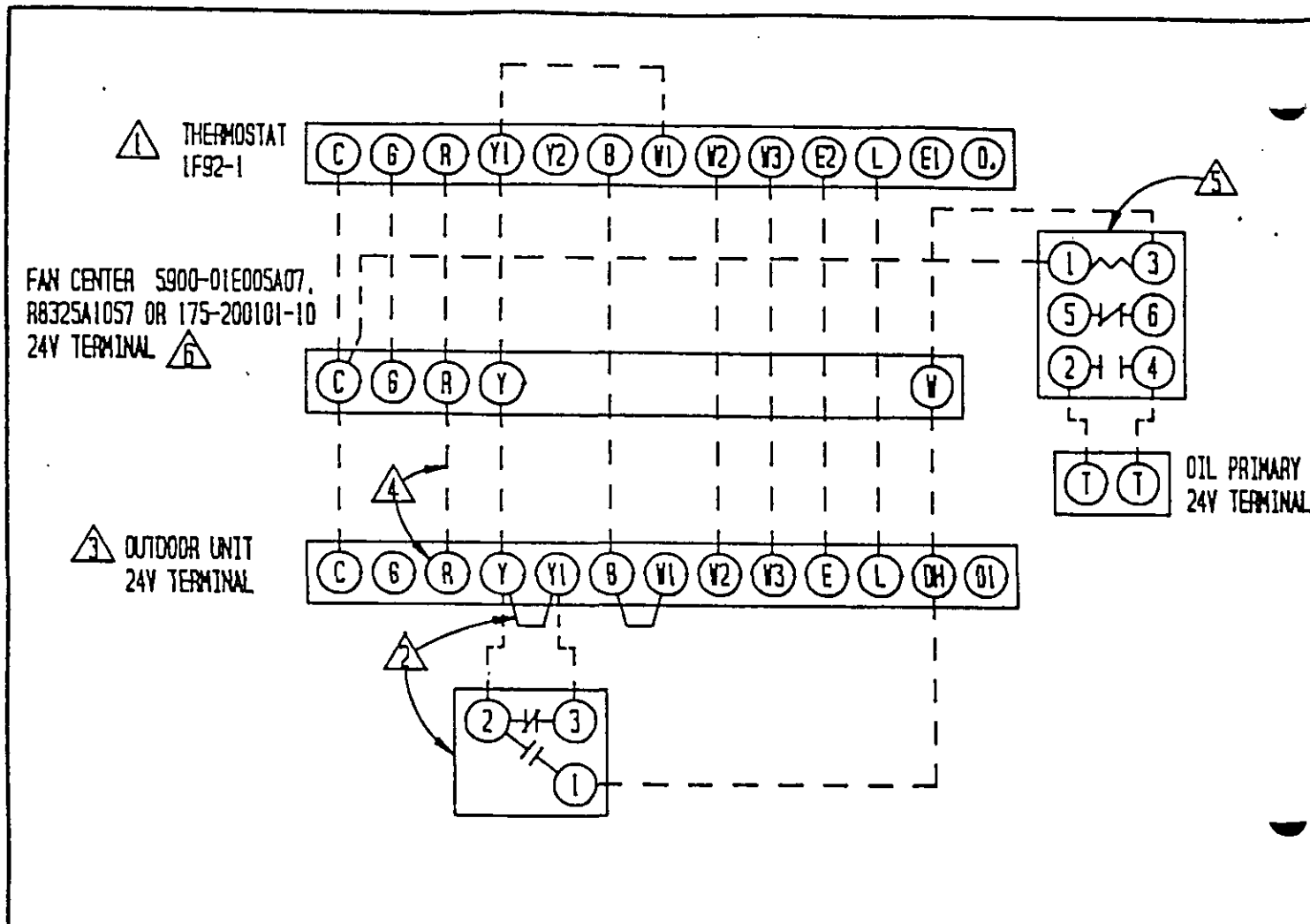

OPTION SWITCH SETTING

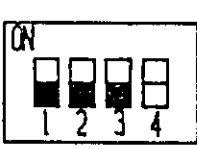

- SWITCH #1 'OFF'
- SWITCH #2 'OFF'
- SWITCH #3 'OFF'
- SWITCH #4 SEE THERMOSTAT INSTALLATION INSTRUCTIONS

WHEN OUTDOOR THERMOSTATE (USED AS CHANGEDOVER THERMOSTAT) IS INSTALLED, REMOVE JUMPER Y-Y1.

IF IT DESIRED NOT TO ALLOW FURNACE TO CYCLE 'ON' DURING DEFROST, A 24V FACTORY WIRE RETURN (TERMINAL '3' OF DEFROST RELAY AND TERMINAL '4' ON EMERGENCY HEAT RELAY ON HPQ MODELS OR TERMINAL ② OF HEATPUMP CONTROL AND TERMINAL ① ON TERMINAL BOARD ON LHP MODELS) MUST BE REMOVED.

- HPQ SERIES MODEL DO NOT HAVE ④ TERMINAL AND IT IS NOT REQUIRED TO RUN ④ WIRE TO THESE MODELS.
- LOCATE ISOLATING RELAY IN OIL FURNACE. NECESSARY TO SEPARATE 24V POWER SUPPLY OF HEATPUMP FROM 24V POWER SUPPLY BUILT INTO OIL BURNER PRIMARY CONTROL.
- IF THE FURNACE IS NOT INTERNALLY WIRED FOR ADD ON AIR CONDITIONING, A FAN CENTER WILL NEED TO BE ADDED.

HEAT PUMP W/OIL FURNACE

	FACTORY WIRING	FIELD WIRING
LOW VOLTAGE	_____	-----
HIGH VOLTAGE	_____	-----

FIGURE 8

IMPORTANT

THESE PROCEDURES MUST BE FOLLOWED AT INITIAL START-UP AND AT ANY TIME POWER HAS BEEN REMOVED FOR 12 HOURS OR LONGER.

TO PREVENT COMPRESSOR DAMAGE WHICH MAY RESULT FROM THE PRESENCE OF LIQUID REFRIGERANT IN THE COMPRESSOR CRANKCASE

- 1. MAKE CERTAIN THE ROOM THERMOSTAT IS IN THE "OFF" POSITION. (THE COMPRESSOR IS NOT TO OPERATE).**
- 2. APPLY POWER BY CLOSING THE SYSTEM DISCONNECT SWITCH. THIS ENERGIZES THE COMPRESSOR HEATER WHICH EVAPORATES THE LIQUID REFRIGERANT IN THE CRANKCASE.**
- 3. ALLOW 4 HOURS OR 60 MINUTES PER POUND OF REFRIGERANT IN THE SYSTEM AS NOTED ON THE UNIT RATING PLATE, WHICHEVER IS GREATER.**
- 4. AFTER PROPERLY ELAPSED TIME THE THERMOSTAT MAY BE SET TO OPERATE THE COMPRESSOR.**
- 5. EXCEPT AS REQUIRED FOR SAFETY WHILE SERVICING — DO NOT OPEN SYSTEM DISCONNECT SWITCH.**

7961-061

SEQUENCE OF OPERATION WHEN USED WITH INDOOR BLOWER COIL

COOLING--Circuit R-Y makes at thermostat pulling in compressor contactor starting the compressor and outdoor motor. The G (indoor motor) circuit is automatically completed on any call for cooling operation, or can be energized by manual fan switch on subbase for constant air circulation.

HEATING--A 24V solenoid coil on reversing valve controls heating cycle operation. Two thermostat options, one allowing "Auto" changeover from cycle to cycle and the other constantly energizing solenoid coil during heating season and thus eliminating pressure equalization noise except during defrost, are to be used. On "Auto" option, a circuit is completed from R-WI and R-Y on each heating "on" cycle, energizing reversing valve solenoid and pulling in compressor contactor starting compressor and outdoor motor. R-G also make starting indoor blower motor. Heat pump heating cycle is now in operation. The second option has no "Auto" changeover position, but instead energizes the reversing valve solenoid constantly whenever the system switch on subbase is placed in "heat" position, the "B" terminal being constantly energized from R. A thermostat demand for heat completes R-Y circuit, pulling in compressor contactor starting compressor and outdoor motor. R-G also make starting indoor blower motor.

For sequence of operation when using add on coils with gas/oil furnaces, refer to the add on coil installation instructions.

TABLE 5

Part No.	Model No.	Description
8403-017	T874R1129	THERMOSTAT--1 stg. cool, 2 stg. heat, 1st stage fixed, 2nd stg. adj. heat anticipators
8404-009	Q674L1181	SUBBASE --System switch: Em. Heat-Heat-Off-Cool Fan switch: On-Auto SPECIAL FEATURE: Manual Changeover (Non-Cycling Rev. Valve) Em. heat light and System check light
8403-018	T874N1024	THERMOSTAT--1 stg. cool, 2 stg. heat, 1st stage fixed, 2nd stg. adj., heat anticipators
8404-010	Q674F1261	SUBBASE --System switch: Off-Cool-Auto-Heat-Em.Ht. Fan switch: On-Auto SPECIAL FEATURE: Auto system changeover, Em. heat light and System check light
8403-024	IF58-45	THERMOSTAT--1 stg. cool, 2 stg. heat, 1st stage fixed, 2nd stg. adj. heater System switch: Em. Heat-Heat-Off-Cool Fan Switch: On-Auto
8403-027	IF92-1	THERMOSTAT--2 stg. cool, 3 stg. heat, electronic SUBBASE --Manual or automatic changeover, 2 set-up/set-back periods per day, 5 or 7 day programming.

IMPORTANT NOTE: All thermostat and subbase combinations shown above incorporate the following features: Man-Auto fan switch, Off-Heat-Cool-Em. Heat Switch, and two (2) indicator lamps--one for emergency heat and one for compressor malfunction.

THERMOSTAT INDICATOR LAMPS

The red lamp marked "EM.HT." comes on and stays on whenever the system switch is placed in the emergency heat position. The green lamp marked "check" will come on if the high pressure switch opens and that prevents the compressor from running. To reset high pressure switch, place thermostat in off position then back to on position.

COMPRESSOR SHORT CYCLE PROTECTION

The solid state heat pump control included with this model has a built in compressor short cycle protection that will prevent the compressor from restarting until compressor has been off for at least five minutes. There is a speed up jumper on the heat pump control that can be used to reduce this time for service of equipment.

DEFROST CYCLE

The defrost cycle is controlled by temperature and time on the solid state heat pump control.

When the outdoor temperature is in the lower 40°F temperature range or colder, the outdoor coil temperature is 32°F or below. This coil temperature is sensed by the coil sensor mounted near the bottom of the outdoor coil. Once the coil temperature reaches 32°F or below, the coil sensor sends a signal to the control logic of the heat pump control and the defrost timer will start.

After 60 (90 or 30) minutes at 32°F or below, the heat pump control will place the system in the defrost mode.

During the defrost mode, the refrigerant cycle switches back to the cooling cycle, the outdoor motor stops, electric heaters are energized, and hot gas passing through the outdoor coil melts any accumulator frost. When the temperature rises to approximately 57°F, the coil sensor will send a signal to the heat pump control which will return the system to heating operations automatically.

If some abnormal or temporary condition such as a high wind causes the heat pump to have a prolonged defrost cycle, the heat pump control will restore the system to heating operation automatically after 10 minutes.

There are three settings on the heat pump control--30 minute, 60 minute, and 90 minute. Most models are shipped wired on the 60 minute setting for greatest operating economy. If special circumstances require a change to another time, remove wire connected to terminal 60 and reconnect to desired terminal.

There is a cycle speed up jumper on the control. This can be used to reduce the time between defrost cycle operation without waiting for time to elapse.

There is an initial defrost (sen jmp) jumper on the control that can be used at any outdoor ambient during the heating cycle to simulate a 0° coil temperature. This can be used to check defrost operation of the unit without waiting for the outdoor ambient to fall into the defrost region.

FIGURE 9

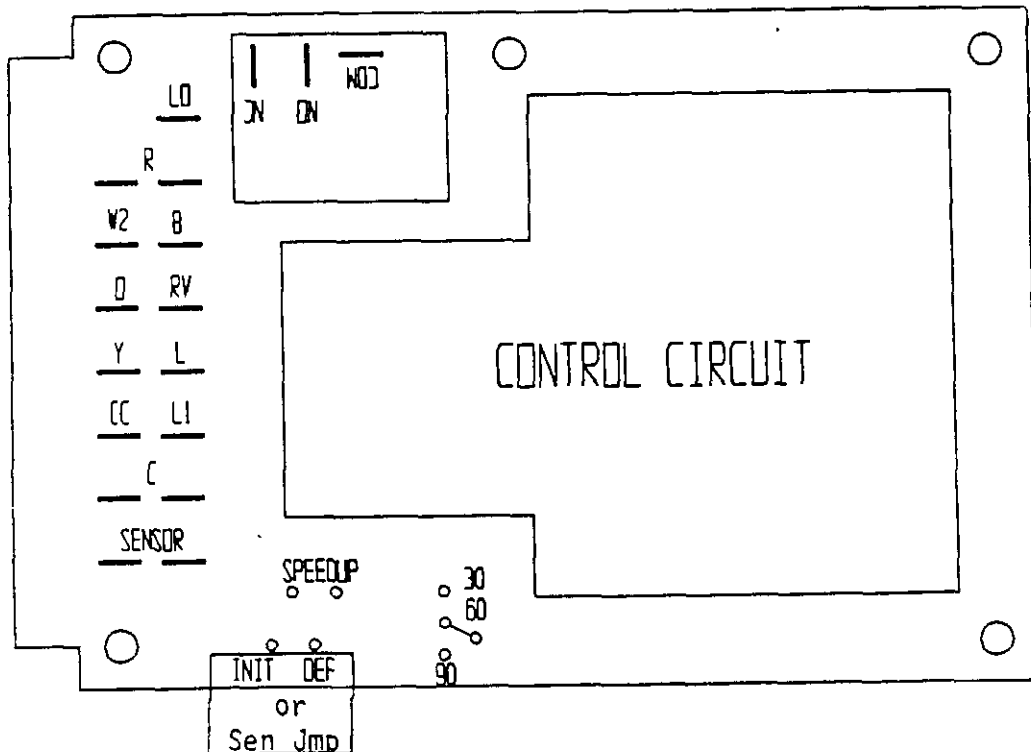

SOLID STATE HEAT PUMP CONTROL TROUBLESHOOTING PROCEDURE

1. Turn on AC power supply to indoor and outdoor units.
2. Turn thermostat blower switch to fan on--The indoor blower should start. (If it doesn't, troubleshoot indoor unit and correct problem).
3. Turn thermostat blower switch to auto position. Indoor blower should stop.
4. Set system switch to heat or cool. Adjust thermostat to call for heat or cool--The indoor blower, compressor, and outdoor fan should start.

NOTE: If there was no power to 24 volt transformer, the compressor and outdoor fan motor will not start for 5 minutes. This is because of the compressor short cycle protection.

Symptom	Possible Causes	What to Check	How To Check Or Repair
Compressor contactor does not energize (cooling or heating)	Control circuit wiring	Check for R connection at outdoor unit, and 24V between R-C.	Run R connection to outdoor unit to power heat pump control.
	Compressor lock out	1. Check for 24V between Ll-C on heat pump control. 2. Check across high pressure switch.	1. If no voltage between Ll-C turn thermostat off and on again to reset high pressure switch. 2. If high pressure switch is open and will not reset, replace high pressure switch.
	Compressor short cycle protection	Check for 24V between CC-C and Y-C on heat pump control.	1. If no voltage between CC-C jumper speed up terminal and within 10 seconds power should appear between CC-C. Remove speed up jumper after 10 seconds.
	Heat pump control defective	Check all other possible causes. Manual 2100-065	Replace heat pump control.
	Contactor defective	Check for open or shorted coil winding.	Replace contactor.
Fan outdoor motor does not run (cooling or heating except during defrost)	Motor defective	Check for open or shorted motor winding	Replace motor.
	Motor capacitor defective	Check capacitor rating. Check for open or shorted capacitor.	Replace capacitor.
	Heat pump control defective	Check across fan relay on heat pump control. (Com-NC)	Replace heat pump control.
Reversing valve does not energize (heating only)	Reversing valve solenoid coil defective	Check for open or shorted coil.	Replace solenoid coil.
	Heat pump control defective	Check for 24V between RV-C and B-C.	1. Check control circuit wiring. 2. Replace heat pump control.
Unit will not go into defrost (heating only)	Temperature sensor or heat pump control defective	Disconnect temperature sensor from board and jumper across speed up terminals and sen jmp terminals. This should cause the unit to go through a defrost cycle within one minute.	1. If unit goes through defrost cycle, replace temperature sensor. 2. If unit does not go through defrost cycle, replace heat pump control.
Unit will not come out of defrost (heating only)	Temperature sensor or heat pump control defective	Jumper across speed up terminals. This should cause the unit to come out of defrost within one minute.	1. If unit comes out of defrost cycle, replace temperature sensor. 2. If unit does not come out of defrost cycle, replace heat pump control.

CHECKING TEMPERATURE SENSOR OUTSIDE UNIT CIRCUIT

1. Disconnect temperature sensor from board and from outdoor coil.
2. Use an ohmmeter and measure the resistance of the sensor. Also use ohmmeter to check for short or open.
3. Check resistance reading to chart of resistance use sensor ambient temperature. (Tolerance of part is $\pm 10\%$).
4. If sensor resistance reads very low, then sensor is shorted and will not allow proper operation of the heat pump control.
5. If sensor is out of tolerance, shorted, open, or reads very low ohms then it should be replaced.

TEMPERATURE F VS RESISTANCE R OF TEMPERATURE SENSOR

F	R	F	R	F	R
-25.0	196871	25.0	39898	75.0	10501
-24.0	190099	26.0	38757	76.0	10247
-23.0	183585	27.0	37652	77.0	10000
-22.0	177318	28.0	36583	78.0	9760
-21.0	171289	29.0	35548	79.0	9526
-20.0	165487	30.0	34545	80.0	9299
-19.0	159904	31.0	33574	81.0	9077
-18.0	154529	32.0	32634	82.0	8862
-17.0	149355	33.0	31723	83.0	8653
-16.0	144374	34.0	30840	84.0	8449
-15.0	139576	35.0	29986	85.0	8250
-14.0	134956	36.0	29157	86.0	8057
-13.0	130506	37.0	28355	87.0	7869
-12.0	126219	38.0	27577	88.0	7686
-11.0	122089	39.0	26823	89.0	7507
-10.0	118108	40.0	26092	90.0	7334
-9.0	114272	41.0	25383	91.0	7165
-8.0	110575	42.0	24696	92.0	7000
-7.0	107010	43.0	24030	93.0	6840
-6.0	103574	44.0	23384	94.0	6683
-5.0	100260	45.0	22758	95.0	6531
-4.0	97064	46.0	22150	96.0	6383
-3.0	93981	47.0	21561	97.0	6239
-2.0	91008	48.0	20989	98.0	6098
-1.0	88139	49.0	20435	99.0	5961
0.0	85371	50.0	19896	100.0	5827
1.0	82699	51.0	19374	101.0	5697
2.0	80121	52.0	18867	102.0	5570
3.0	77632	53.0	18375	103.0	5446
4.0	75230	54.0	17898	104.0	5326
5.0	72910	55.0	17434	105.0	5208
6.0	70670	56.0	16984	106.0	5094
7.0	68507	57.0	16547	107.0	4982
8.0	66418	58.0	16122	108.0	4873
9.0	64399	59.0	15710	109.0	4767
10.0	62449	60.0	15310	110.0	4663
11.0	60565	61.0	14921	111.0	4562
12.0	58745	62.0	14544	112.0	4464
13.0	56985	63.0	14177	113.0	4367
14.0	55284	64.0	13820	114.0	4274
15.0	53640	65.0	13474	115.0	4182
16.0	52051	66.0	13137	116.0	4093
17.0	50514	67.0	12810	117.0	4006
18.0	49028	68.0	12492	118.0	3921
19.0	47590	69.0	12183	119.0	3838
20.0	46200	70.0	11883	120.0	3757
21.0	44855	71.0	11591	121.0	3678
22.0	43554	72.0	11307	122.0	3601
23.0	42295	73.0	11031	123.0	3526
24.0	41077	74.0	10762	124.0	3452

EMERGENCY HEAT POSITION

The operator of the equipment must manually place the system switch in this position. This is done when there is a known problem with the outdoor section, or when the green "check" lamp comes on indicating a problem.

III. CHARGING INSTRUCTIONS

PRESSURE SERVICE PORTS

High and low pressure service ports are installed on all units so that the system operating pressures can be observed. Pressure tables can be found later in the manual covering all models. It is imperative to match the correct pressure table to the unit by model number.

The pressure service ports on the split system heat pump are located on the interconnecting tubing quick connect fittings. An additional low side service port is located on the quick connect mounting plate for low side pressure during heating operation.

REFRIGERANT CHARGE

The correct system R-22 is shown on the unit rating plate. Optimum unit performance will occur with a refrigerant charge resulting in a suction line temperature (6" from compressor) as shown in the following table:

TABLE 6

Models	Rated Airflow	95° F O.D. Temp.	82° F O.D. Temp
24UHPOA/BC24B	800	58 - 60	72 - 74
24UHPOA/A30AQ-B	800	52 - 54	66 - 68
24UHPOA/A30AQ, S-A	800	52 - 54	66 - 68
30UHPOB/BC36B	1050	56 - 58	68 - 70
30UHPOB/A36AQ, S-A	1050	62 - 64	70 - 72
30UHPOB/A42A, S-A	1050	59 - 61	68 - 70
30UHPOB/A37AQ-A	1050	57 - 59	68 - 70
36UHPOB/BC36B	1200	60 - 62	67 - 69
36UHPOB/A36AQ-B	1200	59 - 61	68 - 70
36UHPOB/A36AQ, S-A	1200	59 - 61	68 - 70
36UHPOB/A37AQ-A	1200	55 - 57	68 - 70

NOTE: The suction line temperatures are based upon 80°F dry bulb/67°F wet bulb (50% R.H.) temperature and rated air flow across the indoor coil during cooling cycle.

TOTAL SYSTEM CHARGE FOR SPLIT SYSTEMS

TABLE 7

TOTAL SYSTEM OPERATING CHARGE (Includes charge for the basic outdoor unit, indoor coil and 25' of interconnecting tubing)		
Outdoor Section	Indoor Section	Total R-22 Charge (Oz.)
24UHFPQB	BC24B	109 oz.
	A36AQ-A	112 oz.
30UHFPQB	BC35B	100 oz.
	BC36B	105 oz.
	A36AQ-A	107 oz.
	A36AQ-B	107 oz.
	A37AQ-A	112 oz.
	A42AQ-A	100 oz.
36UHFPQB	BC35B	127 oz.
	BC36B	132 oz.
	A36AQ-B	127 oz.
	A37AQ-A	145 oz.
	A42AQ-A	127 oz.
42UHFPQA	BC48B	180 oz.
	A61AQ-A	186 oz.
48UHFPQB	BC48B	202 oz.
	A61AQ-A	206 oz.
60UHFPQB	BC60B	232 oz.
	A61AQ-A	230 oz.

The above includes 25' of 3/8" diameter liquid line. For other than 25' and other tube sizes, adjust the total charge according to the following schedule.

<u>Liquid Line Diameter</u>	<u>Oz. R-22 Per Ft.</u>
3/8"	.6
1/2"	1.2

INSTALLER NOTE: Stamp or mark the final system charge determined above on the outdoor unit serial plate.

APPLICATION GUIDELINES: For tubing sizes up to 45 feet, use liquid line size and suction line size as shown for precharged tubin sets. For tubing sizes for remote systems between 46 feet and 100 feet in length. Use size recommended in below table based on the 25 foot charged tubing size shown in Table 7.

TABLE 9

Approved 25 Feet Charged Tubing Sizes		Tubing Size Recommended (1)			
		45 - 75 Ft.		76 - 100 Ft.	
Liquid	Vapor	Liquid	Vapor	Liquid	Vapor
1/4"	5/8"	1/4"	3/4"	3/8"	3/4"
1/4"	3/4"	1/4"	7/8"	3/8"	7/8"
3/8"	3/4"	3/8"	7/8"	1/2"	7/8"
3/8"	7/8"	3/8"	7/8"	1/2"	1-1/8"

The basis for selection is to maintain adequate velocity which assures adequate oil return to the compressor, an acceptable pressure drop to assure compressor capacity, and minimum tubing costs.

- (1) These recommendations are based on the use of standard refrigeration tubing.
- (1) Line sizes listed are outside tube dimensions.
- (1) These suggestions do not include consideration for additional pressure drop due to elbows, valves, or reduced joint sizes.
- (1) These recommendations are to be applied to approved combinations of Bard outdoor and indoor sections only.

Charge adjustments for tubing sizes are as follows (2):

TABLE 10

1/4" liquid line	.2 oz. R-22 per foot
3/8" liquid line	.6 oz. R-22 per foot
1/2" liquid line	1.2 oz. R-22 per foot

- (2) These values should only be applied during initial system charging. System operating charge should be adjusted for optimum performance outlined in the installation instructions for that model outdoor section.

III. SERVICE

SERVICE HINTS

1. Caution homeowner to maintain clean air filters at all times. Also, not to needlessly close off supply and return air registers. This reduces air flow through the system, which shortens equipment service life as well as increasing operating costs.
2. Switching to heating cycle at 75°F or higher outside temperature may cause a nuisance trip of the reset high pressure switch.
3. The heat pump wall thermostats perform multiple functions. Be sure that all function switches are correctly set for the desired operating mode before trying to diagnose any reported service problems.
4. Check all power fuses or circuit breakers to be sure that they are the correct rating.
5. Periodic cleaning of the outdoor coil to permit full and unrestricted air flow circulation is essential.

FAN BLADE SETTING DIMENSIONS

Shown in the drawing below are the correct fan blade setting dimensions for proper air delivery across the outdoor coil.

Any service work requiring removal or adjustment in the fan and/or motor area will require that the dimensions below be checked and blade adjusted in or out on the motor shaft accordingly.

FIGURE 10

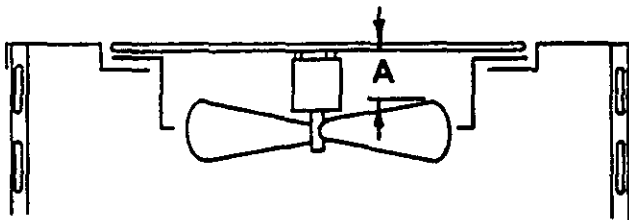

Model	Dimension A
24, 30, 36 UHP	3-1/2

CONNECTION DIAGRAM

DANGER: ELECTRICAL SHOCK HAZARD.
DISCONNECT POWER BEFORE SERVICING

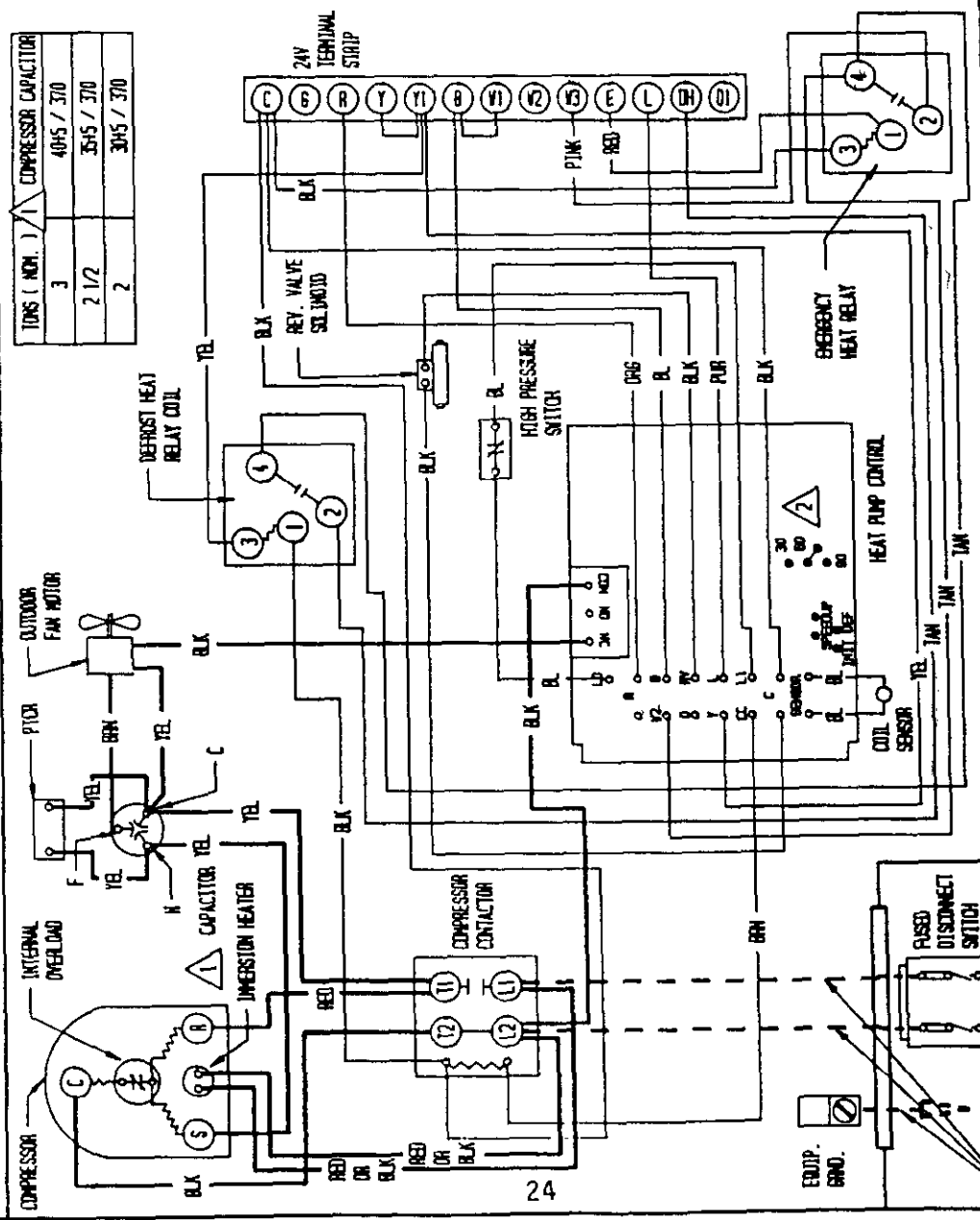

FACTORY SET ON 60 MIN. CYCLE
RECONNECT TO 30 FOR 30 MIN. CYCLE
RECONNECT TO 90 FOR 90 MIN. CYCLE

FACTORY WIRING	FIELD WIRING
---	---
---	---
---	---

Low Voltage
High Voltage

LADDER DIAGRAM

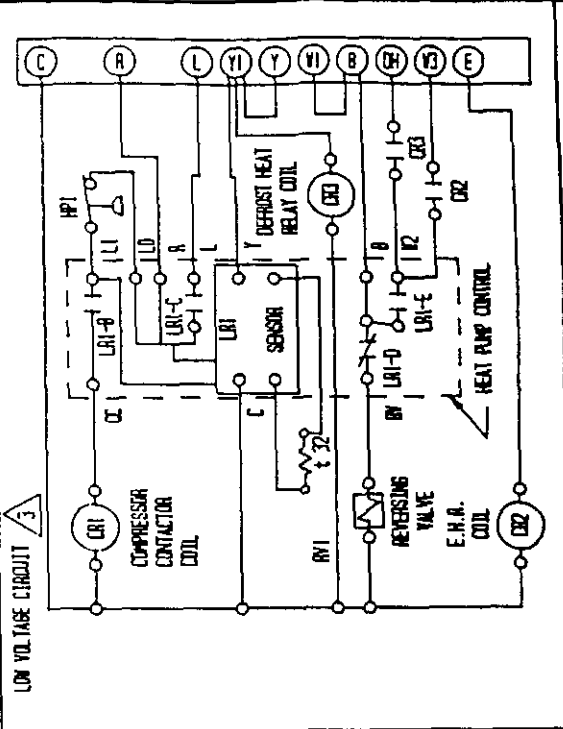
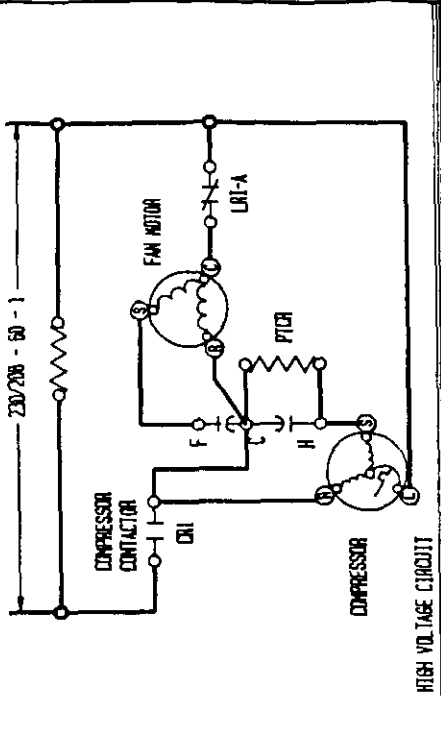

24 VOLTS FOR LOW VOLTAGE CONTROL CIRCUIT SUPPLIED BY INDOOR UNIT TRANSFORMER

OUTDOOR MODEL
24URPQA

TABLE 11

COOLING Air Temperature Entering Outdoor Coil °F

Indoor Model	Return Air Temperature	Pressure	Air Temperature Entering Outdoor Coil °F								
			75	80	85	90	95	100	105	110	115
BC24B Rated CFM 800	75 deg DB	Low Side	66	70	73	75	77	78	79	79	79
	62 deg WB	High Side	170	185	200	216	231	246	262	277	293
	80 deg DB	Low Side	71	75	78	80	82	83	84	85	85
	67 deg WB	High Side	174	190	205	221	237	253	269	285	301
	85 deg DB	Low Side	77	81	84	86	88	89	90	91	91
	72 deg WB	High Side	181	197	213	229	245	261	278	294	311
A30AQ-A A30AQ-B Rated CFM 800	75 deg DB	Low Side	63	66	69	71	73	75	76	77	78
	62 deg WB	High Side	168	183	199	215	230	245	261	276	291
	80 deg DB	Low Side	68	71	74	76	78	80	81	82	83
	67 deg WB	High Side	173	189	204	220	236	252	268	283	299
	85 deg DB	Low Side	72	76	79	82	84	86	87	88	89
	72 deg WB	High Side	178	194	211	228	244	260	277	293	309

TABLE 12

HEATING Air Temperature Entering Outdoor Coil °F

Model	Return Air Temperature	Pressure	Air Temperature Entering Outdoor Coil °F														
			0	5	10	15	17	20	25	30	35	40	45	47	50	55	60
BC24B Rated CFM 800	70 Degree D.B.	Low Side	25	27	30	33	34	36	40	44	48	53	58	60	63	69	75
		High Side	135	149	162	174	178	184	194	203	211	218	234	226	229	233	236
A30AQ-A A30AQ-B Rated CFM 800	70 Degree D.B.	Low Side	20	23	26	29	31	33	38	42	47	52	58	60	64	70	76
		High Side	209	207	208	211	213	217	225	235	248	263	281	289	301	324	349

Low side pressure + 2 PSIG (suction service port @ quick support plate)

High side pressure + 5 PSIG (location line @ outdoor unit quick connect)

Tables are based upon rated CFM (airflow) across the evaporator coil and should be found under section titled "Refrigerant Charge" elsewhere in manual. If there is any doubt as to correct operating charge being in the system, the charge should be removed, system evacuated, and recharged to serial plate instructions.

OUTDOOR UNIT
30UEPOB

COOLING TABLE 13 Air Temperature Entering Outdoor Coil °F

Indoor Model	Return Air Temperature	Pressure	Air Temperature Entering Outdoor Coil °F									
			75	80	85	90	95	100	105	110	115	
BC36B Rated CFM 1050	75 deg. DB	Low Side	69	70	72	73	75	77	78	79	81	
	62 deg. WB	High Side	183	193	206	219	236	254	274	296	319	
	80 deg. DB	Low Side	74	75	77	78	80	82	83	85	86	
	67 deg. WB	High Side	188	198	211	225	242	261	281	304	328	
BC35B Rated CFM 975	85 deg. DB	Low Side	79	81	83	84	86	88	89	91	92	
	72 deg. WB	High Side	195	205	218	233	251	270	291	315	339	
	75 deg. DB	Low Side	66	67	68	69	70	71	73	74	76	
	62 deg. WB	High Side	174	187	200	213	228	243	260	277	294	
A36AQ-A Rated CFM 1050	80 deg. DB	Low Side	71	72	73	74	75	76	78	79	81	
	67 deg. WB	High Side	179	192	205	219	234	250	266	284	302	
	85 deg. DB	Low Side	76	77	78	80	81	82	84	85	87	
	72 deg. WB	High Side	185	199	212	227	242	260	275	294	312	
A37AQ-A Rated CFM 1050	75 deg. DB	Low Side	65	67	69	71	73	75	76	77	78	
	62 deg. WB	High Side	170	186	203	219	236	253	270	287	304	
	80 deg. DB	Low Side	70	72	74	76	78	80	81	82	83	
	67 deg. WB	High Side	175	191	208	225	242	259	277	294	312	
A42AQ-A Rated CFM 1050	85 deg. DB	Low Side	75	77	80	82	84	86	87	88	89	
	72 deg. WB	High Side	181	198	215	233	250	268	287	304	322	
	75 deg. DB	Low Side	67	70	73	75	77	79	80	81	81	
	62 deg. WB	High Side	183	196	210	225	240	256	272	288	305	
A37AQ-A Rated CFM 1050	80 deg. DB	Low Side	74	76	78	80	82	84	85	86	87	
	67 deg. WB	High Side	187	201	216	231	246	262	278	295	313	
	85 deg. DB	Low Side	80	82	84	86	88	90	91	92	93	
	72 deg. WB	High Side	193	208	223	239	255	271	288	305	323	
A42AQ-A Rated CFM 1050	75 deg. DB	Low Side	68	69	71	72	74	76	77	79	80	
	62 deg. WB	High Side	176	189	203	217	233	250	268	288	308	
	80 deg. DB	Low Side	73	74	76	77	79	81	82	84	85	
	67 deg. WB	High Side	181	194	208	223	239	256	275	295	316	
A42AQ-A Rated CFM 1050	85 deg. DB	Low Side	78	80	82	83	85	87	88	90	91	
	72 deg. WB	High Side	187	200	215	231	247	265	285	305	327	

HEATING TABLE 14 Air Temperature Entering Outdoor Coil °F

Model	Return Air Temperature	Pressure	Air Temperature Entering Outdoor Coil °F														
			0	5	10	15	17	20	25	30	35	40	45	47	50	55	60
BC36B Rated CFM 1050	70 DB	Low Side	11	16	21	26	28	31	36	40	45	50	54	56	59	63	68
		High Side	131	143	154	164	168	174	182	191	198	205	211	213	216	221	225
BC35B Rated CFM 975	70 DB	Low Side	20	22	25	29	30	32	36	40	44	48	53	55	58	63	68
		High Side	170	171	173	176	178	181	187	194	202	212	222	227	234	248	262
A36AQ-A Rated CFM 1050	70 DB	Low Side	11	16	21	26	28	31	36	40	45	50	54	56	59	63	68
		High Side	131	144	155	166	170	176	185	193	201	208	214	216	219	223	227
A37AQ-A Rated CFM 1050	70 DB	Low Side	25	25	26	27	28	29	32	36	40	45	51	53	57	64	72
		High Side	152	153	156	159	160	162	167	171	177	183	190	193	198	206	215
A42AQ-A Rated CFM 1050	70 DB	Low Side	20	22	25	28	29	31	35	39	43	48	53	55	58	64	70
		High Side	168	166	165	166	167	168	173	178	185	194	204	208	215	228	243

Low side pressure ± 2 PSIG (suction service port @ quick support plate)
High side pressure ± 5 PSIG (location line @ outdoor unit quick connect)

Tables are based upon rated CFM (airflow) across the evaporator coil and should be found under section titled "Refrigerant Charge" elsewhere in manual. If there is any doubt as to correct operating charge being in the system, the charge should be removed, system evacuated, and recharged to serial plate instructions.

OUTDOOR MODEL

36URPQB

COOLING TABLE 15 Air Temperature Entering Outdoor Coil °F

Indoor Model	Return Air Temperature	Pressure	Air Temperature Entering Outdoor Coil °F									
			75	80	85	90	95	100	105	110	115	
BC36B Rated CFM 1200	75 deg. DB	Low Side	62	64	65	66	68	70	71	73	74	
	62 deg. WB	High Side	180	194	209	222	236	250	263	278	291	
	80 deg. DB	Low Side	67	68	70	71	73	75	76	78	79	
	67 deg. WB	High Side	185	199	214	228	242	256	270	285	299	
BC35B Rated CFM 1125	85 deg. DB	Low Side	72	73	75	76	78	81	82	84	85	
	72 deg. WB	High Side	191	206	221	236	250	265	279	295	309	
	75 deg. DB	Low Side	55	58	60	62	65	66	68	70	71	
	62 deg. WB	High Side	172	188	205	221	238	253	270	285	300	
A36AQ-A A36AQ-B Rated CFM 1200	80 deg. DB	Low Side	59	62	64	67	69	71	73	75	76	
	67 deg. WB	High Side	176	193	210	227	244	260	277	292	308	
	85 deg. DB	Low Side	63	66	68	72	74	76	78	81	82	
	72 deg. WB	High Side	182	199	217	235	252	269	286	302	319	
A37AQ-A Rated CFM 1200	75 deg. DB	Low Side	61	62	64	66	68	70	71	73	74	
	62 deg. WB	High Side	176	192	208	222	238	252	268	283	297	
	80 deg. DB	Low Side	65	67	69	71	73	75	76	78	79	
	67 deg. WB	High Side	180	197	213	228	244	259	275	290	305	
A42AQ-A Rated CFM 1200	85 deg. DB	Low Side	69	72	74	76	78	81	82	84	85	
	72 deg. WB	High Side	186	204	220	236	253	268	285	300	316	
	75 deg. DB	Low Side	67	69	71	73	75	77	79	81	83	
	62 deg. WB	High Side	173	188	203	218	233	248	263	278	293	
A37AQ-A Rated CFM 1200	80 deg. DB	Low Side	72	74	76	78	80	82	84	86	88	
	67 deg. WB	High Side	177	193	208	224	239	254	270	285	301	
	85 deg. DB	Low Side	78	80	82	84	86	88	90	92	94	
	72 deg. WB	High Side	182	199	215	231	247	263	279	295	312	
A42AQ-A Rated CFM 1200	75 deg. DB	Low Side	61	62	64	65	68	70	72	74	76	
	62 deg. WB	High Side	178	192	207	221	237	252	269	285	302	
	80 deg. DB	Low Side	65	67	69	70	73	75	77	79	81	
	67 deg. WB	High Side	183	197	212	227	243	259	276	293	310	
A42AQ-A Rated CFM 1200	85 deg. DB	Low Side	69	72	74	75	78	81	83	85	87	
	72 deg. WB	High Side	189	204	219	235	251	268	286	303	321	

HEATING TABLE 16 Air Temperature Entering Outdoor Coil °F

Model	Return Air Temperature	Pressure	Air Temperature Entering Outdoor Coil °F														
			0	5	10	15	17	20	25	30	35	40	45	47	50	55	60
BC36B Rated CFM 1200	70 D.B.	Low Side	27	26	26	27	28	29	32	36	40	45	51	54	58	66	75
		High Side	167	170	174	178	180	183	189	196	204	213	222	226	232	243	255
BC35B Rated CFM 1125	70 D.B.	Low Side	21	23	25	28	29	31	34	38	42	46	51	53	56	61	67
		High Side	174	185	196	207	211	218	229	240	251	262	273	278	285	296	308
A36AQ-A A36AQ-B Rated CFM 1200	70 D.B.	Low Side	23	24	25	27	28	30	32	36	40	45	50	52	56	62	69
		High Side	162	172	181	190	194	199	208	217	225	233	241	244	249	256	263
A37AQ-A Rated CFM 1200	70 D.B.	Low Side	12	17	21	26	28	31	35	40	44	48	52	54	56	60	64
		High Side	155	161	166	172	174	178	183	190	196	203	209	212	216	223	231
A42AQ-A Rated CFM 1200	70 D.B.	Low Side	27	26	26	27	28	29	32	35	39	44	50	52	56	66	71
		High Side	196	190	186	185	185	186	190	196	204	215	228	234	244	262	282

Low side pressure + 2 PSIG (suction service port @ quick support plate)
 High side pressure + 5 PSIG (location line @ outdoor unit quick connect)

Tables are based upon rated CFM (airflow) across the evaporator coil and should be found under section titled "Refrigerant Charge" elsewhere in manual. If there is any doubt as to correct operating charge being in the system, the charge should be removed, system evacuated, and recharged to serial plate instructions.