

INSTALLATION INSTRUCTIONS

BC24B and BC30B

INDOOR BLOWER COIL UNIT

**FOR USE WITH
SPLIT HEAT PUMP AND
SPLIT AIR CONDITIONER SYSTEMS**

COPYRIGHT FEBRUARY, 1989
BARD MANUFACTURING COMPANY
BRYAN, OHIO

INDEX

I.	Application and Location	5
	General	5
	Unpacking	5
	Application	5
	Ductwork	5
	Location and Clearances	6
	Mounting Positions	6
	Expansion Device	7
	Caution When Using 5780 Series Couplings	8
	Interconnecting Tubing	8
	Condensate Drain	9
II.	Wiring	9
	Thermostat Low-Voltage Wiring	9
	Unit Operation	10
	Air Conditioning With Electric Heat	10
	Heat Pump With Electric Heat	10
	Wall Thermostats A/C and H/P.	13
	How To Set An Adjustable Anticipator	14
	Additional Information For Electric Heat or Heat Pump Applications	15
III.	Service	15
	Three Speed Blower Motor	15
	Filter	16
	Wiring Diagram	17

FIGURES AND TABLES

Figure 1	1
Figure 2	6
Figure 3	7
Figure 4	8
Figure 5	14
Figure 6	15

Table 1	2
Table 2	2
Table 3	3
Table 4	3
Table 5	4
Table 6	5
Table 7	10
Table 8	10
Table 9	10
Table 10	13

BC24B and BC30B
 Upflow - Counterflow - Horizontal
 3 Speed Direct Drive Motor
 Slide-In Return Air Filter

FIGURE 1

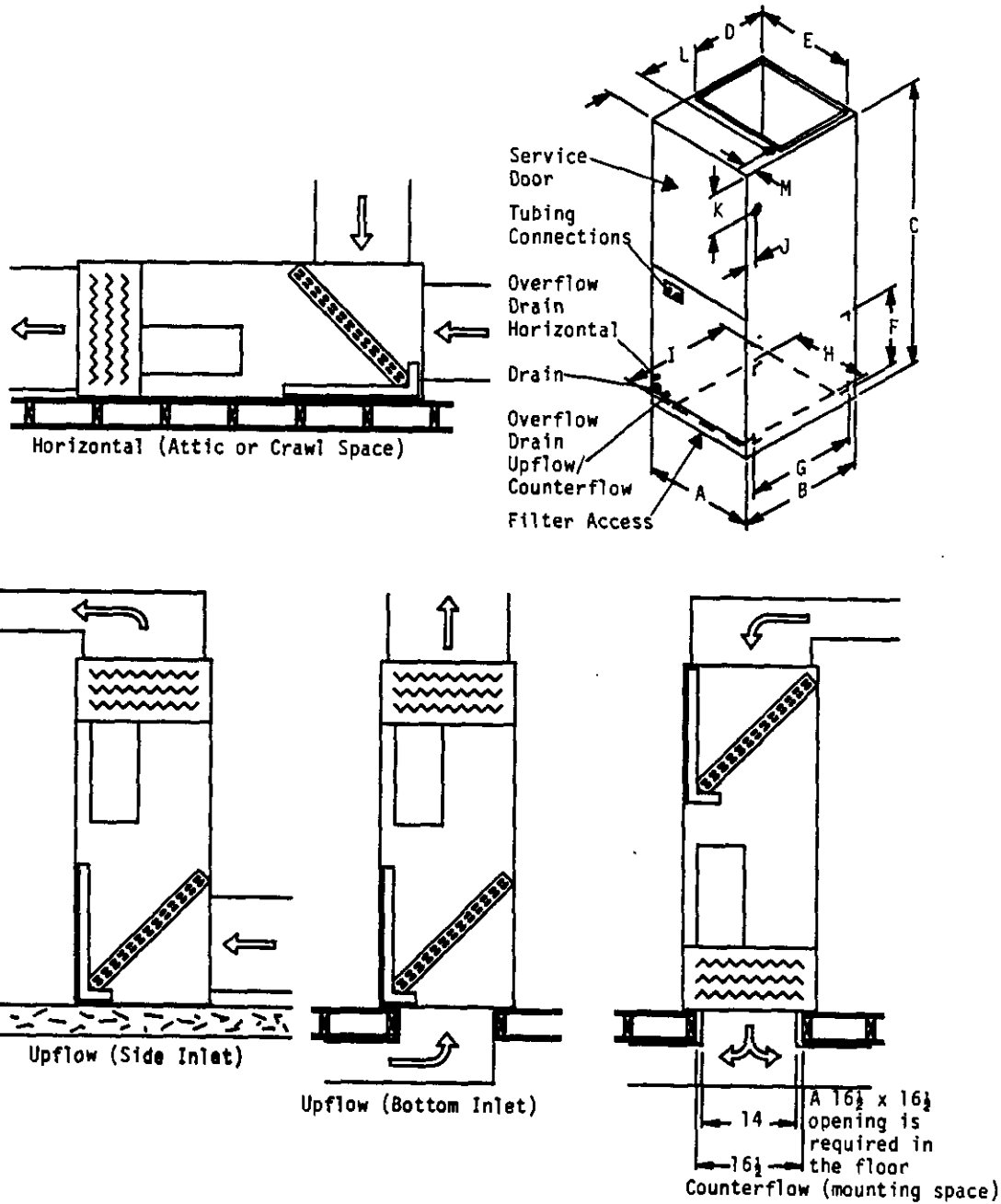

 WARNING: Failure to provide the one inch clearance for the first four feet between the supply duct and a combustible surface can result in fire.

Model	Cabinet Size			Supply Outlet		Side Return Air Opening		Bottom Return Air Opening		Electrical Opening Right Side		Electrical Opening Top	
	A	B	C	D	E	F	G	H	I	J	K	L	M
BC24B													
BC30B	16	23	47	14	14	10	20	12-1/2	19	2	7	2	4-1/2

TABLE 1
 APPROVED MATCHED COMBINATIONS, RATED CFM, E.S.P., ORIFICE
 PART NUMBER AND DIAMETER

Condensing Unit Model Number	Blower Coil Model Number	Rated Airflow 60 HZ		Blower Speed	Recommended Air Flow Range	Orifice Part Number	Orifice Diameter
		CFM	ESP				
24UHPOA	BC24B	800	.35	High	700 - 910	5625-059 (1)	.059
24UACOB	BC24B	800	.35	High	700 - 910	5625-059 (1)	.059
30UACQA	BC30B	850	.25	High	750 - 960	5625-063 (1)	.063
30HPQ6	BC30B	840	.15	High	740 - 950	5625-063 (1)	.063
18HPQ6	BC24B	650	.40	Med	525 - 700	5625-052 (2)	.052
24HPQ6	BC24B	800	.35	High	700 - 910	5625-059 (1)	.059
18BCQ4	BC24B	650	.40	Med	525 - 700	5625-052 (2)	.052
24BCQ5	BC24B	800	.35	High	700 - 910	5625-059 (1)	.059
30BCQ5	BC30B	825	.10	High	725 - 935	5625-063 (1)	.063
31BCQ2	BC30B	825	.10	High	725 - 935	5625-063 (1)	.063
<p>(1) This orifice is shipped installed in the blower coil. When this combination of condensing unit and blower coil is used, the orifice is properly sized.</p> <p>(2) This orifice is <u>not</u> installed in the blower coil. Proper orifice diameter is shipped with outdoor unit packaged with its installation instructions. The orifice <u>must</u> be replaced with the proper orifice shown.</p>							

TABLE 2

Model	BC24B, BC30B
Electrical Rating--60HZ	240/208V 1PH
--50HZ	240/220V 1PH
Operating Voltage Range	197-253
Fusing and Ampacity	See Electric Heat Table
Blower and Motor	10x6 Direct
Motor--RPM/Speed	1100/3 Speed
Motor--HP/AMPS	1/4 / 1.9
Evaporator Face Area	
Sq. Ft./Row/Fins Per Inch	2.75/3/15
Filter--Perm. or Throwaway	12x20x1 T
Refrigerant Cont./R22 Charge	Capillary Tube
Maximum Electric Heat	9KW

TABLE 3
OPTIONAL FIELD-INSTALLED ELECTRIC HEATER TABLE

Heater Package Model No.	Heater Package Volts/Phase	Htr. KW + Capacity @240 Volts		Htr. KW + Capacity @208 Volts		Heater Amps @240/208 Volts	Max. (3) Overcurrnt Protective Device	Number Field Circuits (3)	Minimum Circuit Ampacity (3)	Field Wire Size (4)	Ground Wire Size (5)
		KW	BTU	KW	BTU						
None	---	---	---	---	---	---	15	1	15	14	14
EH2BA-A05N,C	240/208-1	4.5	15345	3.38	11525	18.8/16.3	30	1	27.2	10	10
EH2BA-A09N,C	240/208-1	9	30690	6.75	23018	37.5/32.5	50	1	51	6	10

(3) Includes blower motor

(4) Suggested size based on use of 60 degree C wiring material for ampacities less than 100A.

(5) Based upon table 250-95 degree F 1987 N.E.C.

NOTE: 5kw is the maximum electric heat approved for 50 HZ applications.

TABLE 4
MAXIMUM E.S.P. OPERATION INFORMATION (1) BC24B and BC30B

Outdoor Section/ Type Of Application	Upflow Blower Speed			(2) Counterflow Blower Speed			Horizontal Blower Speed		
	Low	Med.	High	Low	Med.	High	Low	Med.	High
	24UHPQA/ Heat Pump w/9KW	.20	.50	.60	.50	.55	.60	.40	.55
24UHPQA/ Heat Pump w/5KW	.60	.60	.60	.60	.60	.60	.60	.60	.60
30HPQ6/ Heat Pump w/9KW	(3)	.15	.15	(3)	(4)	.15	(3)	.15	.25
30HPQ6/ Heat Pump w/5KW	(3)	.45	.50	(3)	(4)	.50	(3)	.40	.55
All approved combinations 9KW Only	.60	.60	.60	.60	.60	.60	.60	.60	.60
All approved combinations 5KW Only	.60	.60	.60	.60	.60	.60	.60	.60	.60

(1) Values shown are for bottom and side return air opening.

(2) Side inlet not available on counterflow applications.

(3) Low speed not approved in any position on 30HPQ6 application.

(4) Medium speed not approved in counterflow position on 30HPQ6 application.

NOTE: 5kw is the maximum electric heat approved for 50HZ applications.

Table 5
 INDOOR BLOWER COIL PERFORMANCE (DRY COIL @ 230 VOLTS 60 HZ) (1)(2)(3)

Model	KW	Speed	Position	IN H ₂ O							
				.00	.10	.20	.30	.40	.50	.60	
BC24B, BC30B	0	Hi	All	1007	944	934	883	833	773	722	
BC24B, BC30B	0	Med	All	825	818	801	770	735	695	641	
BC24B, BC30B	0	Low	All	---	---	627	613	599	575	542	
BC24B, BC30B	5	Hi	All	992	962	919	868	818	758	707	
BC24B, BC30B	5	Med	All	810	803	786	755	718	680	626	
BC24B, BC30B	5	Low	All	---	---	612	597	582	560	527	
BC24B, BC30B	9	Hi	All	977	947	904	853	803	743	692	
BC24B, BC30B	9	Med	All	795	788	771	740	703	665	611	
BC24B, BC30B	9	Low	All	---	---	597	583	569	545	512	

- (1) Values shown are standard for both bottom and side return air opening.
- (2) Values shown are standard for bottom return air opening, side return air opening not available for counterflow.
- (3) Reduce airflow valves shown by 70 CFM for 208 volt operation.

I. APPLICATION AND LOCATION

GENERAL

Units are shipped completely assembled and internally wired, requiring only duct connections, thermostat wiring and external 208-240 volt AC power supply.

The blower coil units, with various KW electric heat options are suitable for use with the following air conditioner and heat pump outdoor sections. It can be used both as an air conditioning system with electric heat and as a heat pump with electric heat. Refer to sections titled, "AIR CONDITIONING WITH ELECTRIC HEAT and HEAT PUMP WITH ELECTRIC HEAT" for complete information.

TABLE 6
APPROVED COMBINATIONS

Air Conditioning		Heat Pump	
<u>Outdoor Section</u>	<u>Indoor Section</u>	<u>Outdoor Section</u>	<u>Indoor Section</u>
24UACQB	BC24B	24UHPQA	BC24B
30UACQA	BC30B	18HPQ6	BC24B
18ECQ4	BC24B	24HPQ6	BC24B
24ECQ5	BC24B	30HPQ6	BC30B
30ECQ5	BC30B		
31ECQ2	BC30B		

UNPACKING

Upon receipt of equipment, carton should be checked for external signs of damage. If damage is found, request for inspection by carrier's agent should be made in writing immediately.

APPLICATION

Size of unit for a proposed installation should be based on heat loss calculation made according to methods of Air Conditioning Contractors of America. The air duct should be installed in accordance with the Standards of the National Fire Protection Association for the Installation of Air Conditioning and Ventilating Systems of Other Than Residence Type, NFPA No. 90A, and Residence Type Warm Air Heating and Air Conditioning System, NFPA No. 90B. Where local regulations are at a variance with instructions, installer should adhere to local codes.

DUCTWORK

Design the ductwork according to methods given by the Air Conditioning Contractors of America. When duct runs through unheated spaces, it should be insulated with a minimum of two inches of insulation. Use insulation with a vapor barrier on the outside of the insulation. Flexible joints should be used to connect the ductwork to the equipment in order to keep the noise transmission to a minimum.

LOCATION AND CLEARANCES

All access to the equipment is from one side, and at least 24 inches should be provided from this side for service access.

Unit casing is suitable for 0 inch clearance. The first four (4) feet of ductwork attached to the outlet (supply air) connections of the unit are to have a minimum of one inch clearance, with 0 inch clearance for any remaining ductwork.

FIGURE 2

A CFB25 combustibile floor base is required for downflow installations to assure a 1" clearance from combustibile materials to the outlet plenum (duct).

A 16-1/2 x 16-1/2 opening is required in the floor (mounting surface). See illustrations.

The CFB25 combustibile floor base must be ordered separately. It is not included as part of the basic unit.

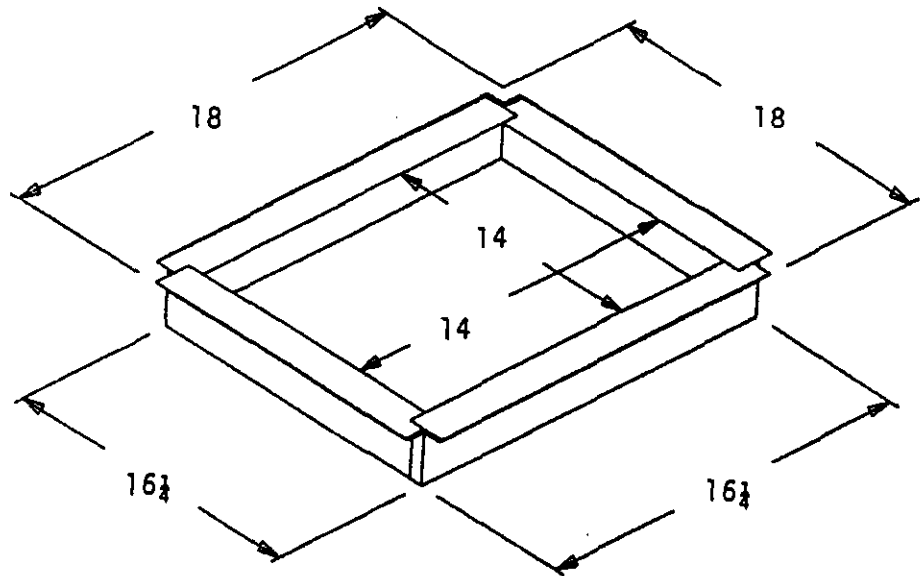

WARNING: Failure to provide the one inch clearance for the first four feet between the supply duct and a combustibile surface can result in fire.

MOUNTING POSITIONS

The blower coil can be installed in three positions with respect to airflow direction: Upflow, horizontal and downflow. The general intent of these mounting positions is shown on the cover page of this installation manual. Capacity and efficiency ratings are certified in the vertical installation position. Capacity may be reduced slightly for other installation positions.

The unit is shipped with the coil installed for upflow or horizontal position. It is secured in place by four screws, two on the top left support angles and two on the top right support angles. To convert to counterflow position, remove front access panel, remove the four screws securing coil pan assembly and remove coil.

Place cabinet in desired mounting position, and reinstall coil as shown on cover page. Make sure the coil is installed as shown with respect to blower.

IMPORTANT: The unit as received has coil installed for upflow/horizontal position only. It must be rotated 180 degrees for downflow positions. See note under "Condensate Drain."

EXPANSION DEVICE

The flow control orifice provides the function of the expansion device as well as distributes the refrigerant equally to all evaporator circuits. It features a "take apart" brass body which houses a removable piston-orifice assembly which meters the proper amount of refrigerant flow and serves as the expansion device. This orifice can be removed and replaced.

The orifice shipped installed with the Flow Control and coil is sized for the most popular evaporator to outdoor unit combination (size to size). Example: Outdoor unit 36UHPQA with BC36B indoor coil. For other combinations of indoor coil to outdoor unit application, the orifice in the flow control device MUST be changed to the size shown in the chart on Table 1. An additional proper sized orifice to be used with each outdoor unit is shipped packaged in the envelop with the installation instructions, with each outdoor unit. The installer should mark the size of the orifice installed on the rating plate of the indoor coil. The diameter of the orifice is stamped on the side of the brass orifice and plastic bag. Example: O63 indicates the orifice is .063" inside diameter.

CAUTION: Be sure there is no dirt introduced into the distributor--orifice assembly. Be sure and install the orifice with the bullet nose pointing in the proper direction as shown in Figure 3. Failure to do so will result in improper operation.

NOTE: If the orifice does not have to be changed, skip the instructions outlined further in Figure 3 and proceed to Figure 4 as applicable.

FIGURE 3
FLOW CONTROL ASSEMBLY
FIELD RESTRICTOR REPLACEMENT INSTRUCTIONS

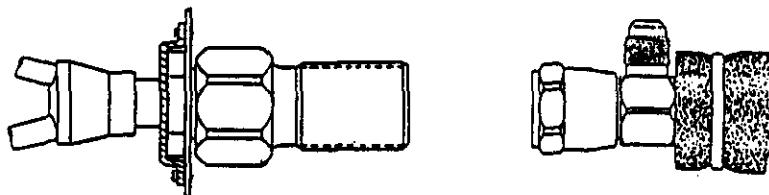

NOTE: DO NOT CONNECT LINE SETS! If restrictor needs to be changed, change out restrictor first.

STEP 1 Remove charge/pressure from indoor unit (if necessary--coupling style).

STEP 2 Disassembly Flow Control Assembly by turning body hex.

STEP 4 If existing restrictor has not dropped out of the body when disassembled, remove by using a pin or paper clip. Discard this original restrictor.

STEP 5 Thread assembly halves together by hand to insure proper mating of threads and tighten until bodies "bottom" or a definite resistance is felt.

STEP 6 Using a marker pen or ink pen, mark a line lengthwise from the union nut to the bulkhead. Then tighten an additional 1/6 turn (or 1 hex flat). The misalignment of the line will show the amount the assembly has been tightened. This final 1/6 turn is necessary to insure the formulation of the leakproof joint.

STEP 7 Complete piping and installation of unit per installation instructions. Figure 4 for detailed assembly instructions for coupling type coils.

CAUTION WHEN USING 5780 SERIES COUPLINGS

If coupling is ever disconnected, the Flow Control Assembly connection may also be loosened. If this should occur, care must be taken to avoid loss of the restrictor. If loosened, repeat Step 5 above to insure the reformation of leakproof joint.

FIGURE 4

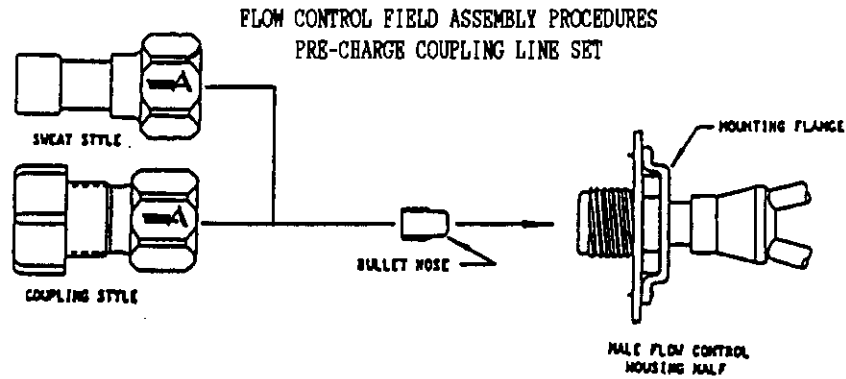

- STEP 8** Route the suction and liquid line between the indoor and outdoor unit. **CAUTION:** Do not connect the tubing to the outdoor unit yet.
- STEP 9** Remove protector caps and plugs.
- STEP 10** If necessary, carefully wipe coupling seats and threaded surfaces with a clean cloth to prevent the inclusion of dirt or any foreign material in the system.
- STEP 11** LUBRICATE male half diaphragm and synthetic rubber seal with refrigerant oil. Thread coupling halves together by hand to insure proper mating of threads. Use proper size wrenches (on line set coupling body hex and on union nut) and tighten until coupling bodies "bottom" or a definite resistance is felt.
- STEP 12** Using a marker or ink pen, mark a line lengthwise from the coupling union nut to the bulkhead. Then tighten an additional 1/4 turn; the misalignment of the line will show the amount the coupling has been tightened. This final 1/4 turn is necessary to insure the formation of leakproof joint. If a torque wrench is used, torque values recommends 10 to 12 foot pounds.
- STEP 13** Evacuate the lines and indoor unit before connecting to the outdoor unit. Refer to the installation instructions packed with the outdoor unit for details on setting the proper refrigerant charge. **NOTE:** The lines and indoor coil do not have to be evacuated if they were not opened to the atmosphere to change the orifice.

INTERCONNECTING TUBING

It is recommended that the interconnecting tubing be the CT series charged tubing sets. This is a precharged tubing set with an insulated suction line. Both suction and liquid line are equipped with the correct quick connect fittings for proper match-up to the indoor and outdoor sections. The CT series is available in standard tubing lengths of 15, 25, 35 and 45 feet.

NOTE: Applicable installation codes may limit installation to single story structure only if return air duct is not used.

CONDENSATE DRAIN

Determine where the drain line will run. This drain line contains cold water and must be insulated to avoid drops of water from dropping on ceiling, etc. A trap must be installed in the primary drain line below the bottom of the drain pan.

For horizontal installations with auxiliary drain pan, a separate drain line should be run from the auxiliary drain pan and terminated where the homeowner can see it. Be certain to show the homeowner the location of the drain line and to explain its purpose. In the event of overflow of primary drain, water will collect in auxiliary pan and run out through the auxiliary drain line.

It is not recommended that any condensate drain lines be connected to sewer main. Drain lines must be installed in accordance with local codes.

When installed horizontal in an attic installation, a platform should be made for the unit to sit on. This platform can be made from 3/4 inch plywood or boards. An auxiliary drain pan should always be used when equipment is installed over a finished living area, to provide protection from water damage in case of plugging of the primary drain line from the unit condensate collection pan.

Secure 4 pieces of cork or live rubber, 4" x 4", of sufficient thickness to allow primary drain to clear edge of auxiliary drain pan, under each corner of the unit.

NOTE: There are two 3/8" copper tubes brazed through the coil drain pan approximately 2 inches from the 3/4 inch main drain pipe coupling. These are overflow drains to control the point at which water would exit the drain pan in the event the primary drain becomes plugged. When ever the coil assembly is removed and reinstalled, make sure the 3/8" drain overflow tubes extend slightly beyond the coil door when in place.

II. Wiring

THERMOSTAT LOW-VOLTAGE WIRING

A 24V terminal block is mounted on the inside of the unit. There is also a 24V terminal block located in the outdoor section of remote heat pumps and two tagged 24V wires in the outdoor section of remote air conditioners. Wire sizing is determined from the table below for 24V control circuit wiring.

<u>Transformer VA</u>	<u>FLA @ 240V</u>	<u>Maximum Distance in Feet</u> ①
40	1.6	20 gauge - 65 18 gauge - 90 16 gauge - 145 14 gauge - 230

① For split systems, this is the maximum distance between the indoor section and outdoor section, and between the indoor section and thermostat each could be up to 90 feet for 18 gauge and 65 feet for 20 gauge on 40VA transformer. With a 65VA transformer and 20 gauge wire, the maximum distance is 40 feet.

Specific control circuit wiring diagrams for the various applications are referenced in the sections titled "AIR CONDITIONING WITH ELECTRIC HEAT and HEAT PUMP WITH ELECTRIC HEAT." These diagrams detail the recommended controls and wiring to allow the best possible operation of the different types of systems with respect to energy conservation while still maintaining close comfort levels for the occupant.

UNIT OPERATION

The controls in the blower coil provide for manual/auto fan control in addition to the staging of the installed electric heat. Staging is accomplished in basic 9KW increments, that is, each two (2) heating elements are controlled by one heat relay.

TABLE 7
HEATER ELEMENT STAGING

Heater KW	Stages
5, 9	1

Heater stage designations are as follows on the 24V terminal strip:

W2	1st stage
W3	2nd stage
DR	3rd stage

AIR CONDITIONING WITH ELECTRIC HEAT

Typical situations would be to utilize a 1-stage cool, 1-stage heat wall thermostat for 5 and 9KW applications, and a 1-stage cool/2-stage heat thermostat for 14 and 18KW applications. Listed below are the appropriate control circuit connection diagrams based upon KW rating and also the number of field installed outdoor thermostats required for each application.

TABLE 8

KW Rating	Connection Diagram	Quantity Of Outdoor Thermostats
0	4091-300	0
5, 9	4091-301	0

HEAT PUMP WITH ELECTRIC HEAT

The system and its safety controls are designed in such a manner that the heat pump and up to 18KW of the resistance strip heaters can operate at the same time, being brought on in stages.

Listed below are the appropriate control circuit connection diagrams based on KW rating, and also the number of field installed outdoor thermostats recommended for each application.

TABLE 9

KW Rating	Connection Diagram	Quantity Of Outdoor Thermostats
0	4091-400	0
5, 9	4091-401	1

In geographical areas where compressor cut-off would not be required because winter temperatures below 10 degrees F are never experienced, disregard the compressor cut-off wiring shown on the control circuit diagram.

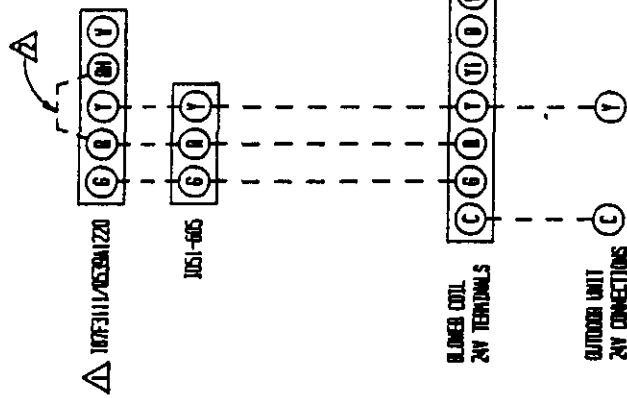

△ SET ADJUST HEAT ANTICIPATOR (SEE BLOWER COIL INSTRUCTIONS).

△ INSTALL JUMPER R-RH

AIR CONDITIONER W/0VX BLOWER COIL

LOW VOLTAGE	FACTORY WIRING	FIELD WIRING
HIGH VOLTAGE	-----	-----

469I-300

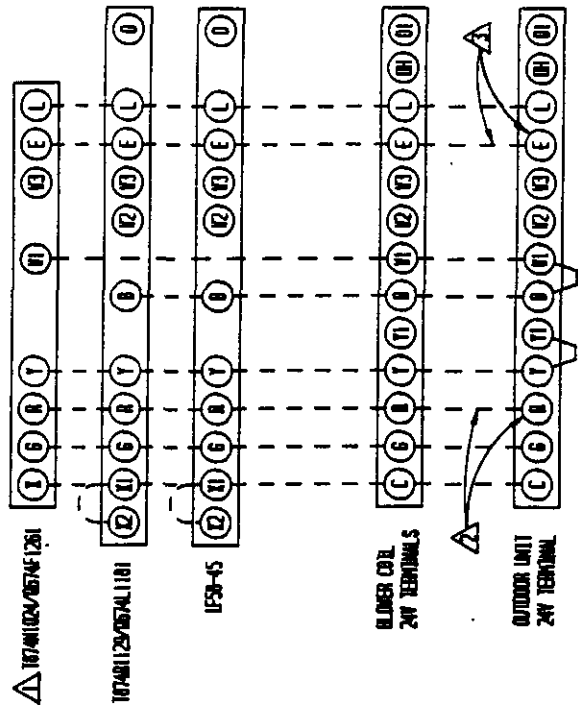

HEATPUMP W/0VX BLOWER COIL

- △ SET ADJUST HEAT ANTICIPATOR (SEE BLOWER COIL INSTRUCTIONS).
- △ 16-35HP UNITS DO NOT HAVE ⑥ TERMINAL AND IT IS NOT REQUIRED TO RUN AN ⑥ WIRE TO THESE MODELS.
- △ 42-50HP UNITS DO NOT HAVE ④ TERMINAL AND IT IS NOT REQUIRED TO RUN AN ④ WIRE TO THESE MODELS.

LOW VOLTAGE	FACTORY WIRING	FIELD WIRING
HIGH VOLTAGE	-----	-----

469I-400

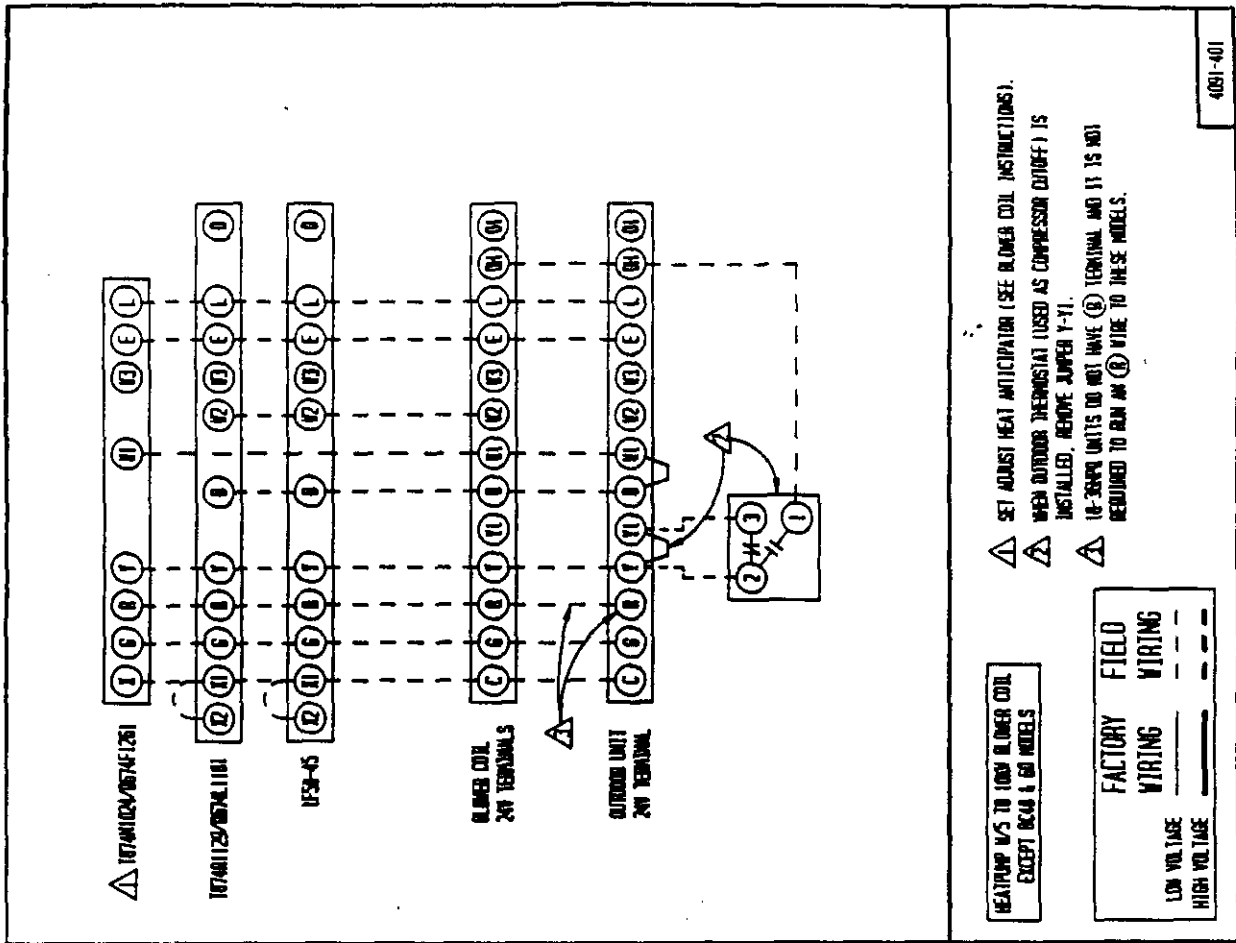
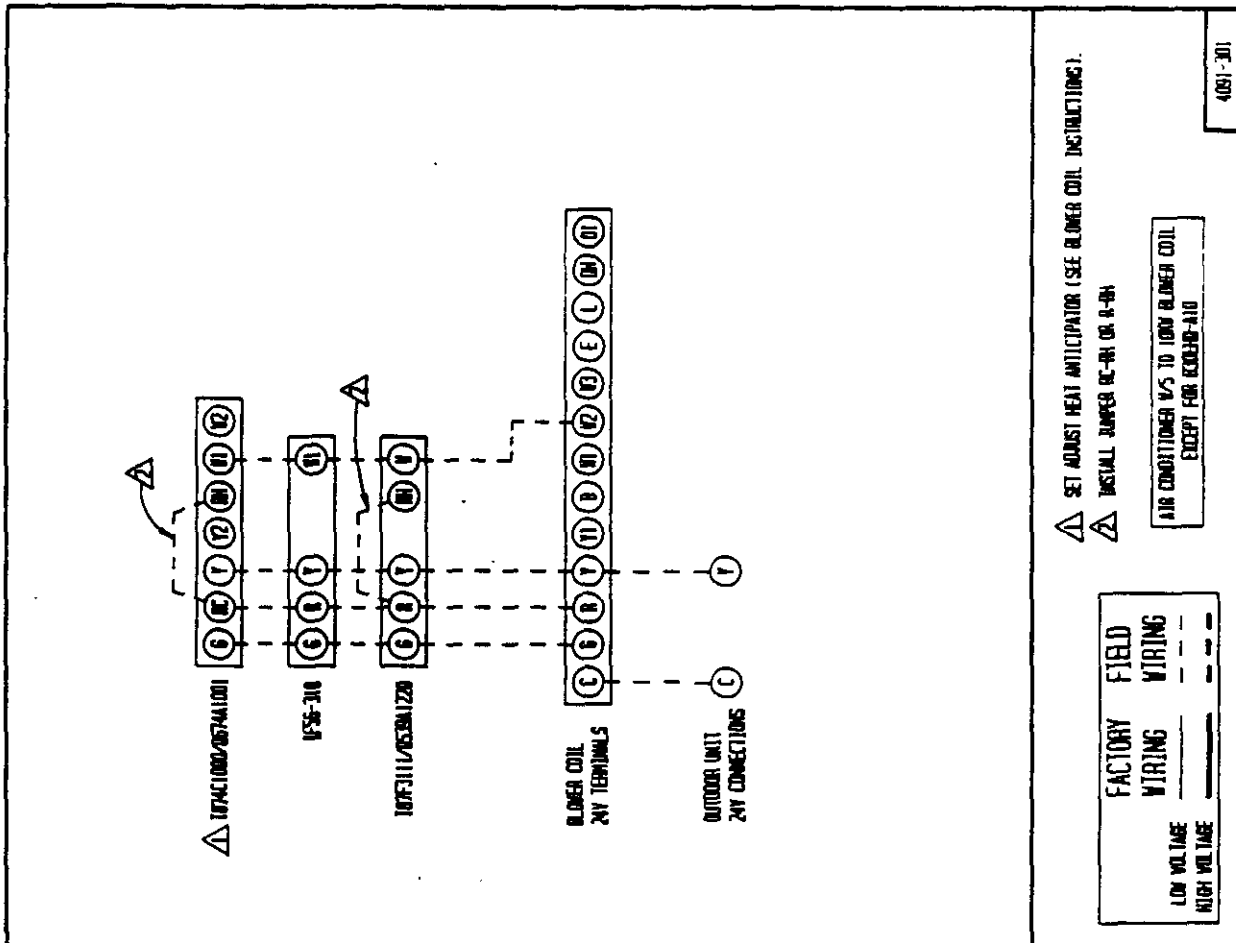

WALL THERMOSTATS

The following wall thermostats and subbases should be used as indicated, depending on the application.

TABLE 10

AIR CONDITIONING THERMOSTATS		
Part No.	Model No.	Description
8403-002	T87F3111	THERMOSTAT--1 stg. heat, adj. heater, Mercury
8404-003	Q539A1220	SUBBASE --System Heat-Off-Cool Fan: On-Auto
8403-008	ID51-605	THERMOSTAT--1 stg. cool, System w/Off Sw. Snap Action Fan: Auto-On
8403-009	IF56-318	THERMOSTAT--1 st. cool, 1 stg. heat, Adj. heater Mercury System: Heat-Off-Cool Fan: Auto-On
8403-019	T874C1000	THERMOSTAT--1 stg. cool, 2 stg. heat, Adj. heater, Mercury
8404-012	Q674A1001	SUBBASE --System: Heat-Auto-Cool Fan: Auto-On
HEAT PUMP THERMOSTATS		
Part No.	Model No.	Description
8403-017	T874R1129	THERMOSTAT--1 stg. cool, 2 stg. heat, 1st stage fixed, 2nd stg. adj. heat anticipators
8404-009	Q674L1181	SUBBASE --System switch: Em. Heat-Heat-Off-Cool Fan switch: On-Auto SPECIAL FEATURE: Manual Changeover (Non-Cycling Rev. Valve) Em. heat light and System check light
8403-018	T874M1024	THERMOSTAT--1 stg. cool, 2 stg. heat, 1st stage fixed, 2nd stg. adj., heat anticipators
8404-010	Q674F1261	SUBBASE --System switch: Off-Cool-Auto-Heat-Em.Ht. Fan switch: On-Auto SPECIAL FEATURE: Auto system changeover, Em. heat light and System check light
8403-024	IF58-45	THERMOSTAT--1 stg. cool, 2 stg. heat, 1st stage fixed, 2nd stg. adj. heater System switch: Em. Heat-Heat-Off-Cool Fan Switch: On-Auto

WARNING: Only the thermostats and subbases listed in Table 13 have been approved for use with the 24UHPQA, 30UHPQA, and 36UHPQA models. Use of any other thermostat/subbase combination can cause a condition of no blower operation during defrost cycle when auxiliary heat is energized causing an unsafe condition and possible fire.

HOW TO SET AN ADJUSTABLE ANTICIPATOR

The primary purpose of the adjustable anticipator thermostat is to provide a single thermostat to match almost any type of primary control in the field today.

Figure 5

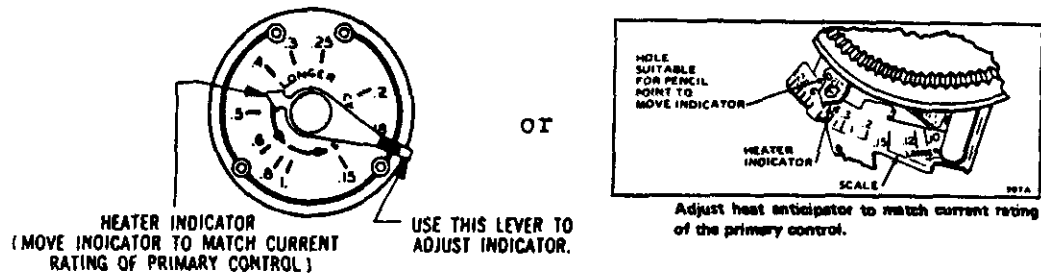

The adjustable heat anticipator has a slide wire adjustment with the pointer scale marked in tenths of an ampere. This is used to set the anticipator to agree with the control amp draw of the control system in use.

If the primary control nameplate has no rating or if further adjustment is necessary, use the following procedure to determine the current draw of each stage.

The current draw of each heating stage must be measured with the thermostat removed and the power on.

1. Connect an AC ammeter of appropriate range between the heating terminals of the subbase.

Stage 1 -- between W1 and RH or R

Stage 2 -- between W2 and RH or R

2. Move the system switch to HEAT or AUTO.
3. After one minute, read the ammeter and record the reading.
4. After mounting the thermostat, set the adjustable heat anticipator(s) to match the respective reading(s) measured in Step 3.

If you want to change the cycle of the heating system, you can make a simple adjustment on the anticipator to do this.

Additional adjustment, if necessary, may be made as follows:

Heater cycles too short--set adjustable heater to a slightly higher dial setting (1/2 division).

Heater cycles too long--set adjustable heater to a slightly lower dial setting (1/2 division).

Occasionally you may find a system where longer or shorter cycles of the primary control are desirable. If the primary control draws .45 amps and you want a longer cycle, set the anticipator to .5 or .6 amps. This puts less resistance in the circuit. With less resistance, but the same current (from the primary control), you will generate less "false" heat and get a longer cycle of the primary control.

If a setting of .45 amps on the adjustable anticipator gives a cycle that is longer than desired, reset the indicator to .3 or .25 amps. This will put more resistance in the circuit and thus generate more "false" heat for shorter cycles.

ADDITIONAL INFORMATION FOR ELECTRIC HEAT OR HEAT PUMP APPLICATIONS

Adjust heat anticipator to match current rating of heating relay for W1 (and W2 if 2 stage). Move indicator on the scale to correspond with this current rating.

If the current rating is not given, proceed as follows:

1. Wrap exactly 10 loops of thermostat wire (W1) around the prongs of an Amprobe.
2. Let the heating system operate for one minute before reading the W1 or W2 current draw.
3. Divide the reading obtained in Step 2 by 10.
4. Use the value calculated in Step 3 to set the heat.
5. Repeat the procedure for (W2) if 2 stage heat anticipator.

NOTE: Cooling anticipators on all thermostats are fixed and do not require setting.

FIGURE 6

Example: $\frac{6.0 \text{ Amp}}{10 \text{ loops}} = .6A$

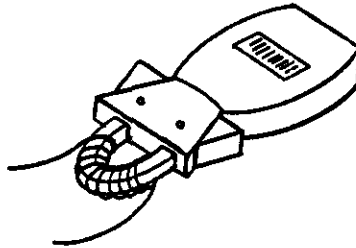

III. Service

THREE SPEED BLOWER MOTOR

The blower coil has a three speed, 1/4 hp blower motor.

Motor lead wire identification is as follows:

Common	Yellow
High	Black
Medium	Blue
Low	Red
Capacitor	Brown (2)

Models are shipped wired on high speed. The unused red (low speed) and blue (medium speed) lead wires are taped off. If another speed operation is desired, remove and tape black wire from terminal com. on blower relay and connect red or blue wire to terminal com. Refer to wiring diagrams for electrical circuitry and to airflow charts for capabilities and limitations on blower speeds, static pressures and air delivery versus installed KW heaters.

FILTER

These units come equipped with a 12" x 20" x 1" thick disposable fiberglass filter and must not be operated without a filter in place. Filter access is gained by removing an angle piece located at the bottom of the main unit cabinet (as viewed in upflow position).

The filter should be replaced periodically throughout the year, as these are year-round heat-cool systems. Special attention should be given to filter cleanliness on any new installation, as airborne dust and debris from recent construction can easily plug a filter in a matter of days.

Dirty filters are the most prevalent and most easily corrected problem to be encountered in any forced air heating and/or cooling system.

CONNECTION DIAGRAM

DANGER: ELECTRICAL SHOCK HAZARD.
 DISCONNECT POWER BEFORE SERVICING.

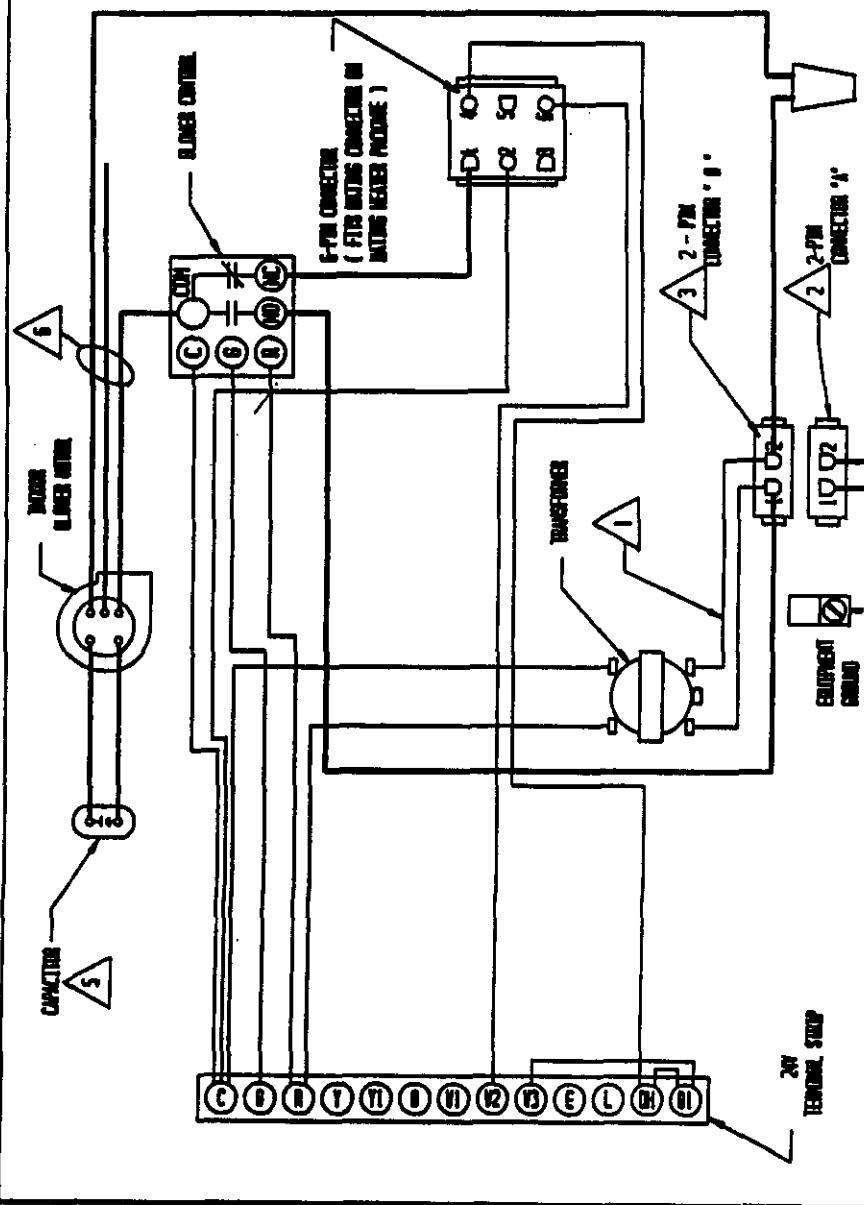

- 1 FOR 200V OPERATION HAVE TWO WIRES IN THE 200V TRANSFORMER TAP
- 2 2-PIN CONNECTOR 'A' USED FOR FIELD CONNECTIONS WHEN NO HEATER PACKAGE IS INSTALLED.
- 3 WHEN HEATER PACKAGE IS INSTALLED, CONNECTOR 'A' CONNECTS TO HEATER CONNECTION ON HEATER PACKAGE.
- 4 REFER TO INSTALLATION INSTRUCTIONS FOR CONTROL CIRCUIT WIRING

FACTORY WIRING	FIELD WIRING
Low Voltage	High Voltage

LADDER DIAGRAM

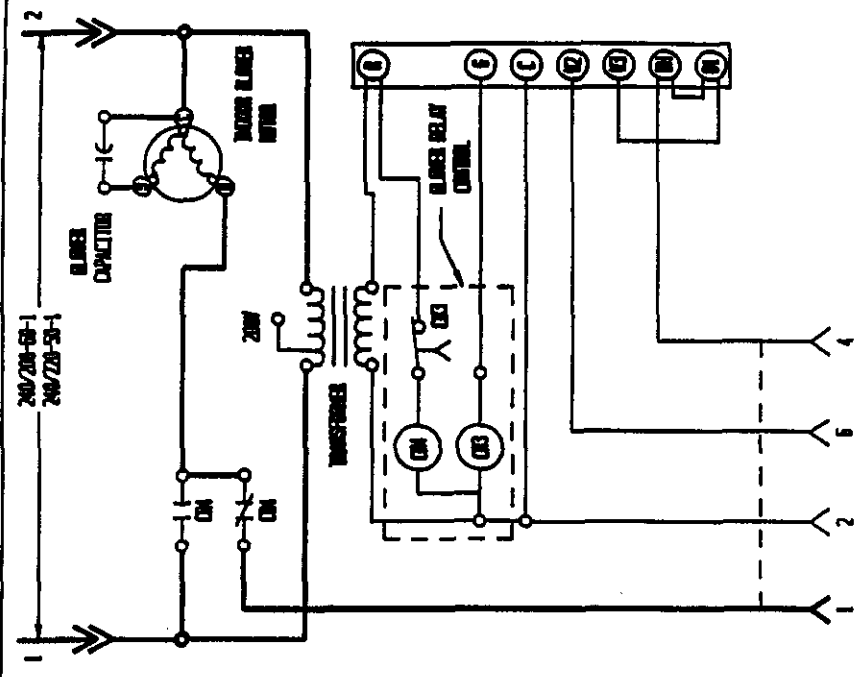

WIRE COLOR	WIRING SPEED
YELLOW	COMMON
BLACK	HIGH
BLUE	MEDIUM (DC240 ONLY)
RED	LOW

WIRE COLOR	WIRING SPEED
YELLOW	COMMON
BLACK	HIGH
BLUE	MEDIUM (DC240 ONLY)
RED	LOW

