

INSTALLATION INSTRUCTIONS

SPLIT AIR CONDITIONER OUTDOOR SECTION

MODELS

**24UACS,QB
30UACS,QA
36UACS,QA
36UACSA-B
42UACS,QB**

**42UACSB-B
48UACS,QB
48UACSB-B
60UACS,QA
60UACSA-B**

**FOR USE WITH:
MATCHING INDOOR BLOWER
COIL UNITS AND MATCHING
ADD ON COIL UNITS ONLY**

**MANUAL 2100-161 REV. F
SUPERSEDES REV. E
FILE VOL. I, TAB 4**

COPYRIGHT JUNE, 1989
BARD MANUFACTURING COMPANY
BRYAN, OHIO

TABLE OF CONTENTS

I.	Application and Location	4
	General	4
	Shipping Damage	4
	Application	4
	Location	5
	Mounting Unit Outside on Slab	5
	Indoor Coil	5
	Important Installer Note	5
	Installing Refrigerant Tubing	5
	Precharged Tubing Connections: Quick Connect Indoor Unit and Quick . . .	6
	Connect Outdoor Unit	
	Sweatstyle Tubing Connections: Sweat Indoor Unit & Sweat Outdoor Unit. . .	8
	Field Fabricated Tubing Connections: Quick Connect Indoor Unit & . . .	9
	Sweat Outdoor Unit Using CTD Kit	
	Field Fabricated Tubing Connections: Sweat Indoor Unit & Quick . . .	12
	Connect Outdoor Unit Using CTO Kit	
II.	Wiring Instructions	14
	General	14
	Control Circuit Wiring	14
	Crankcase Heaters	15
	Wiring Diagrams	16-17
	Wall Thermostats	18
III.	Charging Instructions	18
	Pressure Service Ports	18
	System Start-Up	19
IV.	Service	21
	Service Hints	21
	Fan Blade Setting Dimensions	21
	Wiring Diagrams	22-23
	Pressure Tables	24-29

FIGURES AND TABLES

Figure 1	1
Figure 2	4
Figure 3	5
Figure 4	6
Figure 5	15

Table 1	1
Table 2	2
Table 3	3
Table 4	7
Table 5	11
Table 6	13
Table 7	14
Table 8	15
Table 9	18
Table 10	18
Table 11	19
Table 12	19
Table 13	20
Table 14	21
Table 15	24
Table 16	25
Table 17	26
Table 18	27
Table 19	28
Table 20	29

FIGURE 1

NOMENCLATURE EXPLANATION - Example:

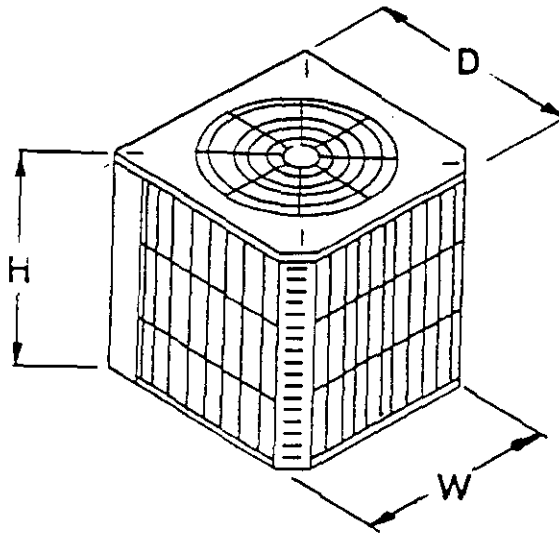
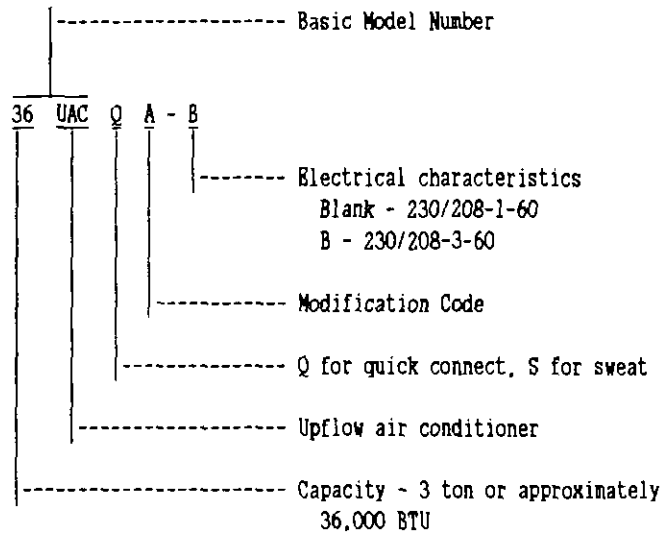

TABLE 1

Basic Model No.	DIMENSIONS		
	"W" Width	"D" Depth	"H" Height
24UAC	32-1/2	32-1/2	26"
30UAC			
36UAC			
42UAC			
48UAC			
60UAC			36"

TABLE 2 RATED CFM AND AIR FLOW DATA (WET COIL--COOLING)

Condensing Unit Model Number	Evaporator Coil Model Number	Rated Airflow		Rated E.S.P. (2)	Motor Speed Tap	Recommended Air Flow Range	System Orifice Required
		CFM	Pressure Drop H2O (1)				
24UACQB 24UACSB	A30AQ-B	825	.15			700 - 910	.059
	A30AQ-A	825	.15			700 - 910	.059*
	A30AS-A						
	BC24B	800		.35	High	700 - 910	.059
	3HCQ1	800	.20			680 - 880	--
30UACQA 30UACSA	A30AQ-A	1000	.20			850 - 1100	.063
	A30AS-A						
	BC35B	1025		.40	Low	870 - 1300	--
	3HCQ1	1000	.30			850 - 1100	--
	BC36B	1050		.35	Low		.063*
36UACQA 36UACSA 36UACSA-B	A36AQ-B	1200	.30			1020 - 1320	.072
	A36AQ-A	1200	.30			1020 - 1320	.069*
	A36AS-A						
	4HCQ	1300	.25			1170 - 1450	--
	BC36B	1200		.30	High	1020 - 1320	.072
42UACQB 42UACSB 42UACSB-B	A42AQ-A	1325	.30			1125 - 1450	.078
	A42AS-A						
	BC48B	1550		.30	Low	1300 - 1675	.078
48UACQB 48UACSB 48UACSB-B	A48AQ-A	1490	.30			1300 - 1675	.081
	A48AS-A						
	BC48B	1700		.25	High	1450 - 1875	.078
	BC60B	1700		.30	High	1450 - 1875	.078*
60UACQA 60UACSA 60UACSA-B	A48AQ-A	1500	.30			1275 - 1650	.092*
	A48AS-A						

(1) Measured across the evaporator coil assembly, including drain pan.

(2) External static pressure available for the duct system - supply and return. All blower coils have multi-speed motors, and value shown is at the recommended rated speed. Consult specification air flow charts with the blower coil units for complete information at other speeds.

***IMPORTANT**

Proper sized orifice is not factory installed in indoor section. Proper orifice size is shipped with outdoor unit packaged with its installation instructions for indoor sections listed on this page. The orifice must be replaced with the proper system orifice shown above in Table 2.

For other evaporator coil models not listed, see indoor coil installation instructions for proper orifice information.

TABLE 3

ELECTRICAL DATA										
MODEL	24UAC*B	30UAC*A	36UAC*A	36UACSA-B	42UAC*B	42UACSB-B	48UACQB	48UACSB-B	60UACQA	60UACSA-B
Electrical Rating--(60HZ/V/PH)	230/208-1			230/208-3	230/208-1	230/208-3	230/208-1	230/208-3	230/208-1	230/208-3
Operating Voltage Range	197 - 253			187 - 253	197 - 253	187 - 253	197 - 253	187 - 253	197 - 253	187 - 253
Minimum Circuit Ampacity	13	19	22	15	24	16	26	19	39	28
+Field Wire Size	#14	#12	#10	#14	#10	#14	#10	#12	#8	#10
++Delay Fuse Max. or Ckt. Bkr.	20	30	35	25	40	25	45	30	60	40
Total Unit Amps 230/208	9.1/10.6	11.6/12.6	15.6/17.6	10.4/11.7	18.5/19	12/12.5	19/21	13.5/15	24.8/27.3	20.6/22.3
Compressor										
Rated Load Amps 230/208	8.1/9.5	10.5/11.7	14.5/16.5	8.9/10.3	17/17.5	10.5/11	17.5/19.5	12/13.5	22.5/25	18.3/20
Branch Ckt Selection Current	9.5	14.1	16.5	10.8	17.5	11	19.5	13.5	28.9	20
Lock Rotor Amps 230/208	49/49	66/66	75.8/75.8	65/65	105/105	85/85	102/102	91/91	138/138	103/103
Fan Motor & Condenser										
Fan Motor--HP/RPM	1/6 - 825			1/4 - 825			1/3 - 1075			
Fan Motor--Amps	1.1			1.5			2.3			
Fan--DIA/CFM	24" - 3000			24" - 3100			24" - 3100			
+60 deg. C copper wire size.										
++Maximum time delay fuse or HACR type circuit breaker										
*Applies to sweat and quick connect type.										

I. APPLICATION AND LOCATION

GENERAL

These instructions explain the recommended method to install the air cooled remote type condensing unit, the interconnecting refrigerant tubing, and the electrical wiring connections to the unit.

The condensing units are to be used in conjunction with the matching evaporator coils or evaporator blower units for comfort cooling applications as shown in the specification sheet.

These instructions and any instructions packaged with any separate equipment required to make up the entire air conditioning system should be carefully read before beginning the installation. Note particularly "Connecting Quick-Connect Couplings, Starting Procedure" and any tags and/or labels attached to the equipment.

While these instructions are intended as a general recommended guide, they do not supersede any national and/or local codes in any way. Authorities having jurisdiction should be consulted before the installation is made.

SHIPPING DAMAGE

Upon receipt of equipment, the carton should be checked for external signs of shipping damage. If damage is found, the receiving party must contact the last carrier immediately, preferably in writing, requesting inspection by the carrier's agent.

APPLICATION

Size of unit for a proposed installation should be based on heat loss calculation made according to methods of Air Conditioning Contractors of America. The air duct should be installed in accordance with the Standards of the National Fire Protection Association for the Installation of Air Conditioning and Ventilating Systems of Other Than Residence Type, NFPA No. 90A, and Residence Type Warm Air Heating and Air Conditioning Systems, NFPA 90B. Where local regulations are at a variance with instructions, installer should adhere to local codes.

FIGURE 2

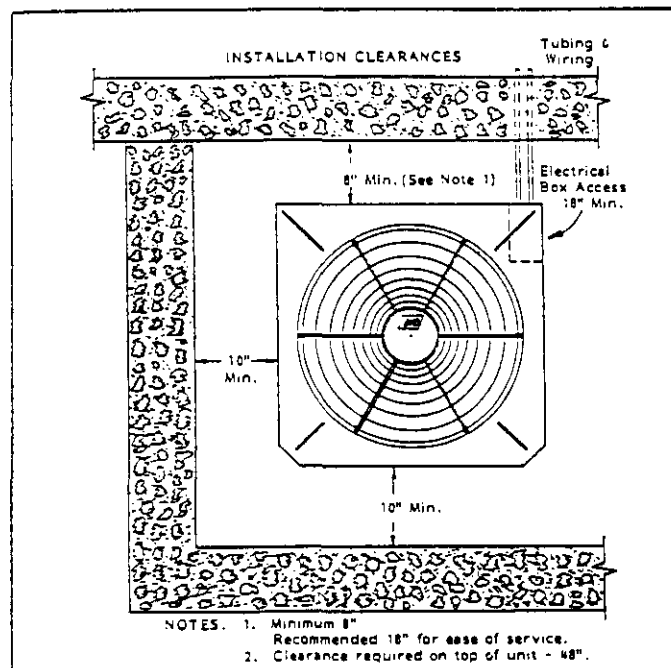

LOCATION

The condensing unit is designed to be located outside with free and unobstructed condenser air inlet and discharge. It must also permit access for service and installation. Condenser air enters the coil on three sides and discharges upward from the top. Refrigerant and electrical connections are made from the rear of the unit as shown in Figure 2 with electrical service access on the right side. The unit can be installed with the rear of the unit "close to the wall", however, additional service clearance at the back of the unit would be desirable if practical for unit service. The compressor can be serviced through the top.

MOUNTING UNIT OUTSIDE ON SLAB

A solid level base or platform, capable to support the unit's weight, must be set at the outdoor unit predetermined location. The base should be at least two inches larger than the base dimensions of the unit and at least two inches higher than surrounding grade level. The required unit minimum installed clearances must be maintained as called out in Figure 2 when locating and setting the base.

Remove the unit from its shipping carton and position the unit on the prepared base or platform.

Do not attach the unit or its base to the building structure to avoid the transmission of noise into the occupied area.

NOTE: These units employ internally sprung compressors; therefore, it is not necessary to remove or loosen the base mounting bolts on the compressor prior to operation.

Consideration should be given to the electrical and tubing connections when placing the unit to avoid unnecessary bends or length of material.

IMPORTANT INSTALLER NOTE:

For improved start-up performance, wash the indoor coil with a dishwasher detergent.

INSTALLING REFRIGERANT TUBING

The information that follows on installing refrigerant tubing and for changing the system orifice (if required) covers applications listed in the front of this installation instruction only. Although other indoor units may be of similar construction, the installation instructions for these units should be consulted for proper installation of those units prior to installation.

This information is provided for the field service personnel to install refrigerant tubing in compliance with Section 608 of Title VI National Recycling and Emission Reduction Program for the U.S. Clean Air Act effective July 1, 1992.

Consult manual 2100-002 on procedure for leak test--evacuation--charging before installation refrigerant tubing that requires any refrigerant recovery or system evacuation. Manual 2100-002 is included with the unit installation instruction package when shipped from the factory.

FIGURE 3

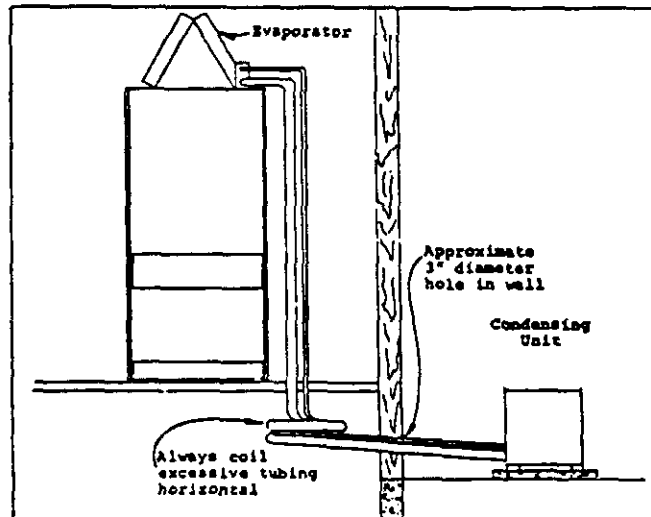

PRECHARGED TUBING CONNECTIONS: QUICK CONNECT INDOOR UNIT AND QUICK CONNECT OUTDOOR UNIT (1)

Examine carefully the two lengths of precharged tubing furnished with the system. The larger is the suction line and the smaller is the liquid line. The end of the tubing with the hex nut and gauge port is to be attached to the outdoor unit.

STEP 1--Unroll the tubing, being careful not to kink and route both the suction line and liquid line between the indoor unit and outdoor unit.

Before fastening either end, use a tubing bender to make any necessary bends in tubing. When necessary to bend the insulated tube suction line, cut the insulation around its circumference at a distance far enough beyond the point of the bend so as to clear the tubing bender. Slip the insulation back together and vapor seal the joint with tape. Coil any excess tubing in a horizontal place with the slope of the tubing toward the condensing unit.

CAUTION: 1. Be careful not to tear the insulation when pushing it through hole in masonry or frame walls. 2. When sealing the tube opening in house wall, use a soft material to prevent tube damage and vibration transmission. 3. Avoid excessive bending in any one place to avoid kinking.

NOTE: DO NOT CONNECT LINE SETS! If orifice needs to be changed, change out orifice first.

If the orifice does not have to be changed, skip the instructions outlined further in Step 2 and proceed to Step 9.

STEP 2--To Recover charge from the indoor unit.

- A. Connect the suction line only to the indoor unit as outlined in Steps 9, 10, and 11.
- B. Recover indoor unit and suction line unit charge through service port located on suction line.

STEP 3--Disassemble Flow Control Assembly by turning body hex.

STEP 4--If existing orifice has not dropped out of the body when disassembled, remove by using a pin or paper clip. Discard this original orifice.

STEP 5--Insert proper sized orifice fully into the flow control body with rounded "bullet" nose towards the unit as shown. Insure the orifice stays inserted in body before connecting mating half. See chart in the outdoor unit installation instructions for proper size.

CAUTION: Be sure there is no dirt introduced into the flow control--orifice assembly. Be sure and install the orifice with the bullet nose pointing in the proper direction as shown in Figure 4. Failure to do so will result in improper operation.

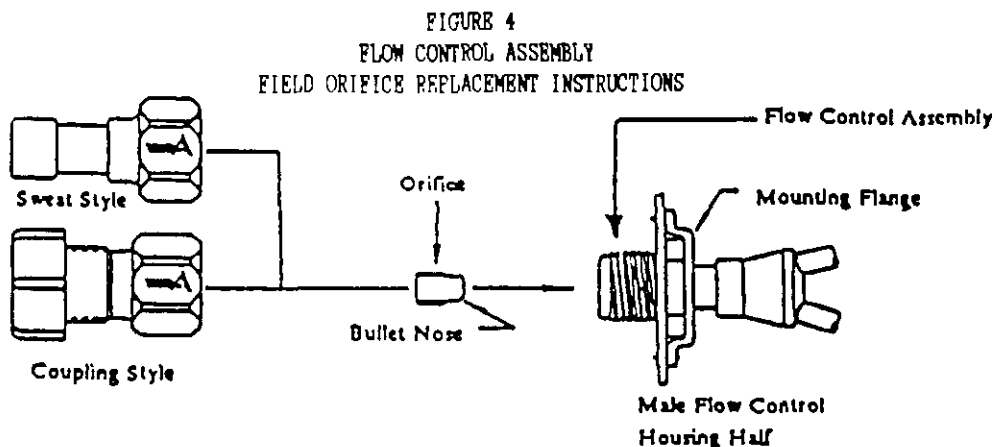

STEP 6--Thread assembly halves together by hand to insure proper mating of threads and tighten until bodies "bottom" or a definite resistance is felt.

STEP 7--Using a marker pen or ink pen, mark a line lengthwise from the union nut to the bulkhead. Then tighten an additional 1/6 turn (or 1 hex flat). The misalignment of the line will show the amount the assembly has been tightened. This final 1/6 turn is necessary to insure the formation of the leakproof joint.

STEP 8--Evacuate the suction line and indoor unit through service port located on suction line before connecting all other tubing. Refer to section later in installation instructions for details on setting the proper refrigerant charge.

STEP 9--Remove (remaining) protector caps and plugs (if orifice was changed), inspect fittings and if necessary carefully wipe coupling seats and threaded surfaces with a clean cloth to prevent the inclusion of dirt or any foreign material in the system.

STEP 10--Lubricate male half diaphragm and synthetic rubber seal with refrigerant oil. Starting with the indoor coil thread coupling halves together by hand to insure proper mating of threads. Be sure to hold the coupling firmly to prevent movement of the coupling and tubing. Failure to do so could tear out the diaphragm causing a blockage of the system. Use proper size wrenches (on coupling body hex and on union nut) and tighten until coupling bodies "bottom" or a definite resistance is felt.

CAUTION: After starting to tighten up the fitting, never try to back it off or take it apart.

STEP 11--Using a marker or ink pen, mark a line lengthwise from the coupling union nut to the bulkhead. Then tighten an additional 1/4 turn. The misalignment of the line will show the amount the coupling has been tightened. This final 1/4 turn is necessary to insure the formation of leak proof joint. If a torque wrench is used, the following torque values are recommended:

TABLE 4

Coupling Size	Ft. Lbs.
-6	10 - 12
-10	35 - 45
-11	35 - 45
-12	50 - 65

Repeat Step 10 and 11 on outdoor section making sure to locate the gauge port in a 45° angle from a vertical up position so as to be accessible for gauge connections.

STEP 12--Leak test all connections using an electronic leak detector or a halide torch.

STEP 13--When tubing is installed in attics or drop ceilings, insulate the couplings on the larger tube thoroughly with 3/8" wall thickness, closed cell sponge tube insulation or equivalent. Failure to insulate will result in water damage to ceiling since the fitting will "sweat" and drop water on the ceiling.

(1) NOTE: The maximum distance for precharge tubing between the outdoor and indoor unit is 45 feet.

SWEATSTYLE TUBING CONNECTIONS: SWEAT INDOOR UNIT AND SWEAT OUTDOOR UNIT

Use only refrigeration grade (dehydrated and sealed) copper tubing. Care must be taken to insure that the tubing is kept clean and dry before and during installation. Do not remove the plugs from the tubing ends, coil connections or base valves until the connection is ready to be brazed.

The suction line must be insulated with a minimum of 3/8" Armaflex or equivalent before cutting and making connections.

STEP 1--Being careful not to kink, route both the suction line and liquid line between the indoor unit and outdoor unit. Use a tubing bender to make any necessary bends in tubing. When necessary to bend the insulated tube suction line, cut the insulation around its circumference at a distance far enough beyond the point of the bend so as to clear the tubing bender. Slip the insulation back together and vapor seal the joint with tape. Coil any excess tubing in a horizontal place with the slope of the tubing toward the condensing unit.

CAUTION: 1. Be careful not to tear the insulation when pushing it through hole in masonry or frame walls. 2. When sealing the tube opening in house wall, use a soft material to prevent tube damage and vibration transmission. 3. Avoid excessive bending in any one place to avoid kinking.

STEP 2--The tubing ends should be cut square. Make sure it is round and free of burrs at the connecting ends. Clean the tubing to prevent contaminants from entering the system.

NOTE:

DO NOT BRAZE LINE TO UNITS! If orifice needs to be changed, change out orifice first.

If the orifice does not have to be changed, skip the instructions outlined further in Step 3 and proceed to Step 8.

STEP 3--Disassemble Flow Control Assembly by turning body hex.

STEP 4--If existing orifice has not dropped out of the body when disassembled, remove by using a pin or paper clip. Discard this original orifice.

STEP 5--Insert proper sized orifice fully into the flow control body with rounded "bullet" nose towards the unit as shown. Insure the orifice stays inserted in body before connecting mating half. See chart in the outdoor unit installation instructions for proper size.

CAUTION: Be sure there is no dirt introduced into the flow control--orifice assembly. Be sure and install the orifice with the bullet nose pointing in the proper direction as shown in Figure 4. Failure to do so will result in improper operation.

STEP 6--Thread assembly halves together by hand to insure proper mating of threads and tighten until bodies "bottom" or a definite resistance is felt.

STEP 7--Using a marker pen or ink pen, mark a line lengthwise from the union nut to the bulkhead. Then tighten an additional 1/6 turn (or 1 hex flat). The misalignment of the line will show the amount the assembly has been tightened. This final 1/6 turn is necessary to insure the formation of the leakproof joint.

STEP 8--Wrap a wet rag around the copper stub before brazing.

STEP 9--Flux the copper tube and insert into the stub. Braze the joint using an alloy of silver or copper and phosphorus with a melting temperature above 1100°F for copper to copper joints. The phosphorus will act as a flux, therefore, no flux will be required.

A copper-silver alloy with a high silver content should be used when iron or steel material is involved in the joint. These alloys require the use of silver solder flux. Alloys containing phosphorus should not be used with iron or steel. Phosphorus reacts with the iron, forming iron phosphate which is extremely brittle.

CAUTION: 1. Brazing alloys with a melting temperature below 700°F should not be used. 2. Lead-tin or tin-antimony solders should not be used due to their low melting point and necessity for corrosive fluxes.

To further prevent the formation of copper oxide inside the tubing, dry nitrogen may be purged through the refrigerant system during brazing.

WARNING: Never purge or pressurize a system with oxygen. An explosion and fire will result.

STEP 10--After brazing, quench with wet rag to cool the joint and remove any flux residue.

STEP 11--Leak test all connections using an electronic leak detector or a halide torch.

STEP 12--Evacuate suction line, liquid line, and indoor unit through outdoor unit base valves.

STEP 13--Open both the suction and liquid base valves to the fully open position. Refer to section later in installation instructions for details on setting proper system charge.

FIELD FABRICATED TUBING CONNECTIONS: QUICK CONNECT INDOOR UNIT AND SWEAT OUTDOOR UNIT USING CTO KIT

Use only refrigeration grade (dehydrated and sealed) copper tubing. Care must be taken to insure that the tubing is kept clean and dry before and during installation. Do not remove the plugs from the tubing ends, coil connections or base valves until the connection is ready to be brazed.

The suction line must be insulated with a minimum of 3/8" Armaflex or equivalent before cutting and making connections.

STEP 1--Being careful not to kink, route both the suction line and liquid line between the indoor unit and outdoor unit. Use a tubing bender to make any necessary bends in tubing. When necessary to bend the insulated tube suction line, cut the insulation around its circumference at a distance far enough beyond the point of the bend so as to clear the tubing bender. Slip the insulation back together and vapor seal the joint with tape. Coil any excess tubing in a horizontal place with the slope of the tubing toward the condensing unit.

CAUTION: 1. Be careful not to tear the insulation when pushing it through hole in masonry or frame walls. 2. When sealing the tube opening in house wall, use a soft material to prevent tube damage and vibration transmission. 3. Avoid excessive bending in any one place to avoid kinking.

STEP 2--The tubing ends should be cut square. Make sure it is round and free of burrs at the connecting ends. Clean the tubing to prevent contaminants from entering the system.

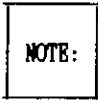

DO NOT make any tubing connection at indoor unit at this time. Make all brazing of joints and evacuate both suction and liquid line first.

STEP 3--Wrap a wet rag around the copper stub before brazing.

STEP 4--Flux the copper tube and insert into the stub. Braze the joint using an alloy of silver or copper and phosphorus with a melting temperature above 1100°F for copper to copper joints. The phosphorus will act as a flux, therefore, no flux will be required.

A copper-silver alloy with a high silver content should be used when iron or steel material is involved in the joint. These alloys require the use of silver solder flux. Alloys containing phosphorus should not be used with iron or steel. Phosphorus reacts with iron, forming iron phosphate which is extremely brittle.

CAUTION: 1. Brazing alloys with a melting temperature below 700°F should not be used. 2. Lead-tin or tin-antimony solders should not be used due to their low melting point and necessity for corrosive fluxes.

To further prevent the formation of copper oxide inside the tubing, dry nitrogen may be purged through the refrigerant system during brazing.

WARNING: Never purge or pressurize a system with oxygen. An explosion and fire will result.

STEP 5--After brazing, quench with wet rag to cool the joint and remove any flux residue.

STEP 6--Leak test all connections using an electronic leak detector or a halide torch.

STEP 7--Evacuate suction line and liquid line through outdoor unit base valves.

If orifice does not have to be changed, skip the instructions outlined further in Step 8 and proceed to Step 15.

STEP 8--Recover charge from the indoor unit.

- A. Connect the suction line only to the indoor unit as outlined in Steps 15, 16 and 17.
- B. Recover indoor unit and suction line unit charge through service port located on outdoor unit base valve.

STEP 9--Disassemble Flow Control Assembly by turning body hex.

STEP 10--If existing orifice has not dropped out of the body when disassembled, remove by using a pin or paper clip. Discard this original orifice.

STEP 11--Insert proper sized orifice fully into the flow control body with rounded "bullet" nose towards the unit as shown. Insure the orifice stays inserted in body before connecting mating half. See chart in the outdoor unit installation instructions for proper size.

CAUTION: Be sure there is no dirt introduced into the flow control--orifice assembly. Be sure and install the orifice with the bullet nose pointing in the proper direction as shown in Figure 4. Failure to do so will result in improper operation.

STEP 12--Thread assembly halves together by hand to insure proper mating of threads and tighten until bodies "bottom" or a definite resistance is felt.

STEP 13--Using a marker pen or ink pen, mark a line lengthwise from the union nut to the bulkhead. Then tighten an additional 1/6 turn (or 1 hex flat). The misalignment of the line will show the amount the assembly has been tightened. This final 1/6 turn is necessary to insure the formation of the leakproof joint.

STEP 14--Evacuate the suction line and indoor unit through the outdoor unit base valve before connecting all other tubing. Refer to section later in installation instructions for details on setting the proper refrigerant charge.

STEP 15--Remove (remaining) protector caps and plugs (if orifice was changed). Inspect fittings and if necessary carefully wipe coupling seats and threaded surfaces with a clean cloth to prevent the inclusion of dirt or any foreign material in the system.

STEP 16--Lubricate male half diaphragm and synthetic rubber seal with refrigerant oil. Thread coupling halves together by hand to insure proper mating of threads. Be sure to hold the coupling firmly to prevent movement of the coupling and tubing. Failure to do so could tear out the diaphragm causing a blockage of the system. Use proper size wrenches (on coupling body hex and on union nut) and tighten until coupling bodies "bottom" or a definite resistance is felt.

CAUTION: After starting to tighten up the fitting, never try to back it off or take it apart.

STEP 17--Using a marker or ink pen, mark a line lengthwise from the coupling union nut to the bulkhead. Then tighten an additional 1/4 turn. The misalignment of the line will show the amount the coupling has been tightened. This final 1/4 turn is necessary to insure the formation of leak proof joint. If a torque wrench is used, the following torque values are recommended.

TABLE 5

Coupling Size	Ft. Lbs.
-6	10 - 12
-10	35 - 45
-11	35 - 45
-12	50 - 65

STEP 18--Leak test all connections using an electronic leak detector or a halide torch.

STEP 19--When tubing is installed in attics or drop ceilings, insulate the couplings on the larger tube thoroughly with 3/8" wall thickness, closed cell sponge tube insulation or equivalent. Failure to insulate will result in water damage to ceiling since the fitting will "sweat" and drop water on the ceiling.

STEP 20--Open both the suction and liquid base valves to the fully open position. Refer to section later in installation instructions for details on setting proper system charge.

FIELD FABRICATED TUBING CONNECTIONS: SWEAT INDOOR UNIT AND QUICK CONNECT OUTDOOR UNIT USING CTO KIT

Use only refrigeration grade (dehydrated and sealed) copper tubing. Care must be taken to insure that the tubing is kept clean and dry before and during installation. Do not remove the plugs from the tubing ends, coil connections or base valves until the connection is ready to be brazed.

The suction line must be insulated with a minimum of 3/8" Armaflex or equivalent before cutting and making connections.

STEP 1--Being careful not to kink, route both the suction line and liquid line between the indoor unit and outdoor unit. Use a tubing bender to make any necessary bends in tubing. When necessary to bend the insulated tube suction line, cut the insulation around its circumference at a distance far enough beyond the point of the bend so as to clear the tubing bender. Slip the insulation back together and vapor seal the joint with tape. Coil any excess tubing in a horizontal place with the slope of the tubing toward the condensing unit.

CAUTION: 1. Be careful not to tear the insulation when pushing it through hole in masonry or frame walls. 2. When sealing the tube opening in house wall, use a soft material to prevent tube damage and vibration transmission. 3. Avoid excessive bending in any one place to avoid kinking.

STEP 2--The tubing ends should be cut square. Make sure it is round and free of burrs at the connecting ends. Clean the tubing to prevent contaminants from entering the system.

NOTE:	Do not braze lines to indoor unit or make any tubing connections at outdoor unit at this time.
--------------	--

If the orifice does not have to be changed, skip the instructions outlined further in Step 3 and proceed to Step 8.

STEP 3--Disassemble Flow Control Assembly by turning body hex.

STEP 4--If existing orifice has not dropped out of the body when disassembled, remove by using a pin or paper clip. Discard this original orifice.

STEP 5--Insert proper sized orifice fully into the flow control body with rounded "bullet" nose towards the unit as shown. Insure the orifice stays inserted in body before connecting mating half. See chart in the outdoor unit installation instructions for proper size.

CAUTION: Be sure there is no dirt introduced into the flow control--orifice assembly. Be sure and install the orifice with the bullet nose pointing in the proper direction as shown in Figure 4. Failure to do so will result in improper operation.

STEP 6--Thread assembly halves together by hand to insure proper mating of threads and tighten until bodies "bottom" or definite resistance is felt.

STEP 7--Using a marker pen or ink pen, mark a line lengthwise from the union nut to the bulkhead. Then tighten an additional 1/6 turn (or 1 hex flat). The misalignment of the line will show the amount the assembly has been tightened. This final 1/6 turn is necessary to insure the formation of the leakproof joint.

STEP 8--DO NOT make any tubing connection at outdoor unit at this time. Make all brazing of joints and evacuate both suction line, liquid line, and indoor coil first.

Wrap a wet rag around the copper stub before brazing.

STEP 9--Flux the copper tube and insert into the stub. Braze the joint using an alloy of silver or copper and phosphorus with a melting temperature above 1100°F for copper to copper joints. The phosphorus will act as a flux, therefore, no flux will be required.

A copper-silver alloy with a high silver content should be used when iron or steel material is involved in the joint. These alloys require the use of silver solder flux. Alloys containing phosphorus should not be used with iron or steel. Phosphorus reacts with iron, forming iron phosphate which is extremely brittle.

CAUTION: 1. Brazing alloys with a melting temperature below 700°F should not be used. 2. Lead-tin or tin-antimony solders should not be used due to their low melting point and necessity for corrosive fluxes.

To further prevent the formation of copper oxide inside the tubing, dry nitrogen may be purged through the refrigerant system during brazing.

WARNING: Never purge or pressurize a system with oxygen. An explosion and fire will result.

STEP 10--After brazing, quench with wet rag to cool the joint and remove any flux residue.

STEP 11--Leak test all connections using an electronic leak detector or a halide torch.

STEP 12--Evacuate the suction line, liquid line, and indoor unit through service ports located on suction and liquid line before connecting to outdoor unit. Refer to section later in installation instructions for details on setting the proper refrigerant charge.

STEP 13--Remove (remaining) protector caps and plugs (on outdoor unit). Inspect fittings and if necessary carefully wipe coupling seats and threaded surfaces with a clean cloth to prevent the inclusion of dirt or any foreign material in the system.

STEP 14--Lubricate male half diaphragm and synthetic rubber seal with refrigerant oil. Start with the indoor coil, thread coupling halves together by hand to insure proper mating of threads. Be sure to hold the coupling firmly to prevent movement of the coupling and tubing. Failure to do so could tear out the diaphragm causing a blockage of the system. Use proper size wrenches (on coupling body hex and on union nut) and tighten until coupling bodies "bottom" or a definite resistance is felt.

CAUTION: After starting to tighten up the fitting, never try to back it off or take it apart.

STEP 15--Using a marker or ink pen, mark a line lengthwise from the coupling union nut to the bulkhead. Then tighten an additional 1/4 turn: The misalignment of the line will show the amount the coupling has been tightened. This final 1/4 turn is necessary to insure the formation of leak proof joint. If a torque wrench is used, the following torque values are recommended.

TABLE 6

Coupling Size	Ft. Lbs.
-6	10 - 12
-10	35 - 45
-11	35 - 45
-12	50 - 65

STEP 16--Leak test all connections using an electronic leak detector or a halide torch.

STEP 17--When tubing is installed in attics or drop ceilings, insulate the couplings on the larger tube thoroughly with 3/8" wall thickness, closed cell sponge tube insulation or equivalent. Failure to insulate will result in water damage to ceiling since the fitting will "sweat" and drop water on the ceiling.

II. WIRING INSTRUCTIONS

GENERAL

All wiring must be installed in accordance with the National Electrical Code and local codes. In Canada, all wiring must be installed in accordance with the Canadian Electrical Code and in accordance with the regulations of the authorities having jurisdiction. Power supply voltage must conform to the voltage shown on the unit serial plate. A wiring diagram of the unit is attached to the inside of the electrical cover. The power supply shall be sized and fused according to the specifications supplied. A ground lug is supplied in the control compartment for equipment ground.

The unit rating plate lists a "Maximum Time Delay Fuse" or "HACR Type" circuit breaker that is to be used with the equipment. The correct size must be used for proper circuit protection and also to assure that there will be no nuisance tripping due to the momentary high starting current of the compressor motor.

CONTROL CIRCUIT WIRING

For split systems, the minimum control circuit wiring gauge needed to insure proper operation of all controls in both indoor and outdoor units will depend on two factors.

1. The rated VA of the control circuit transformer.
2. The maximum total distance of the control circuit wiring. (This is the distance between the wall thermostat to the indoor unit plus the distance between the indoor unit to the outdoor unit.)

The following table should be used to determine proper gauge of control circuit wiring required.

TABLE 7

Rated VA of Control Circuit Transformer	Transformer Secondary FLA @ 24V	Maximum Total Distance of Control Circuit Wiring In Feet
40	1.6	20 gauge - 65
		18 gauge - 90
		16 gauge - 145
		14 gauge - 230
50	2.1	20 gauge - 45
		18 gauge - 60
		16 gauge - 100
		14 gauge - 160
65	2.7	20 gauge - 40
		18 gauge - 55
		16 gauge - 85
		14 gauge - 135
		12 gauge - 210

Example: 1. Control circuit transformer rated at 40VA.

2. Maximum total distance of control circuit wiring 85 feet.

From Table 7, minimum of 18 gauge wire should be used in the control circuit wiring.

For control circuit transformers rated other than those listed, use the next lower rated transformer listed.

Example: 1. Control circuit transformer rated at 55VA.

From table use 50VA transformer.

There are two (2) separate control diagrams for fossil fuel furnaces with air conditioners.

Control diagrams for the various circuits which could be encountered with blower coils can be found in the installation instructions of the blower coil.

TABLE 8

System	Gas Furnace Control Diagram	Oil Furnace Control Diagram
All Models	4091-100	4091-101

CRANKCASE HEATERS

All models have an insertion well-type heater located in the lower section of the compressor housing. This is a self-regulating type heater that draws only enough power to maintain the compressor at a safe temperature.

Some form of crankcase heat is essential to prevent liquid refrigerant migrating to the compressor causing oil pump out on compressor start-up and possible valve failure due to compressing a liquid.

Refer to unit wiring diagram to find exact type of crankcase heater used.

The decal in Figure 5 is affixed to all outdoor units detailing start-up procedure. This is very important. Please read carefully.

FIGURE 5

IMPORTANT

THESE PROCEDURES MUST BE FOLLOWED AT INITIAL START-UP AND AT ANY TIME POWER HAS BEEN REMOVED FOR 12 HOURS OR LONGER.

TO PREVENT COMPRESSOR DAMAGE WHICH MAY RESULT FROM THE PRESENCE OF LIQUID REFRIGERANT IN THE COMPRESSOR CRANKCASE

1. MAKE CERTAIN THE ROOM THERMOSTAT IS IN THE OFF POSITION. (THE COMPRESSOR IS NOT TO OPERATE).
2. APPLY POWER BY CLOSING THE SYSTEM DISCONNECT SWITCH THIS ENERGIZES THE COMPRESSOR HEATER WHICH EVAPORATES THE LIQUID REFRIGERANT IN THE CRANKCASE.
3. ALLOW 4 HOURS OR 60 MINUTES PER POUND OF REFRIGERANT IN THE SYSTEM AS NOTED ON THE UNIT RATING PLATE WHICHEVER IS GREATER.
4. AFTER PROPERLY ELAPSED TIME THE THERMOSTAT MAY BE SET TO OPERATE THE COMPRESSOR.
5. EXCEPT AS REQUIRED FOR SAFETY WHILE SERVICING — DO NOT OPEN SYSTEM DISCONNECT SWITCH.

7961-061

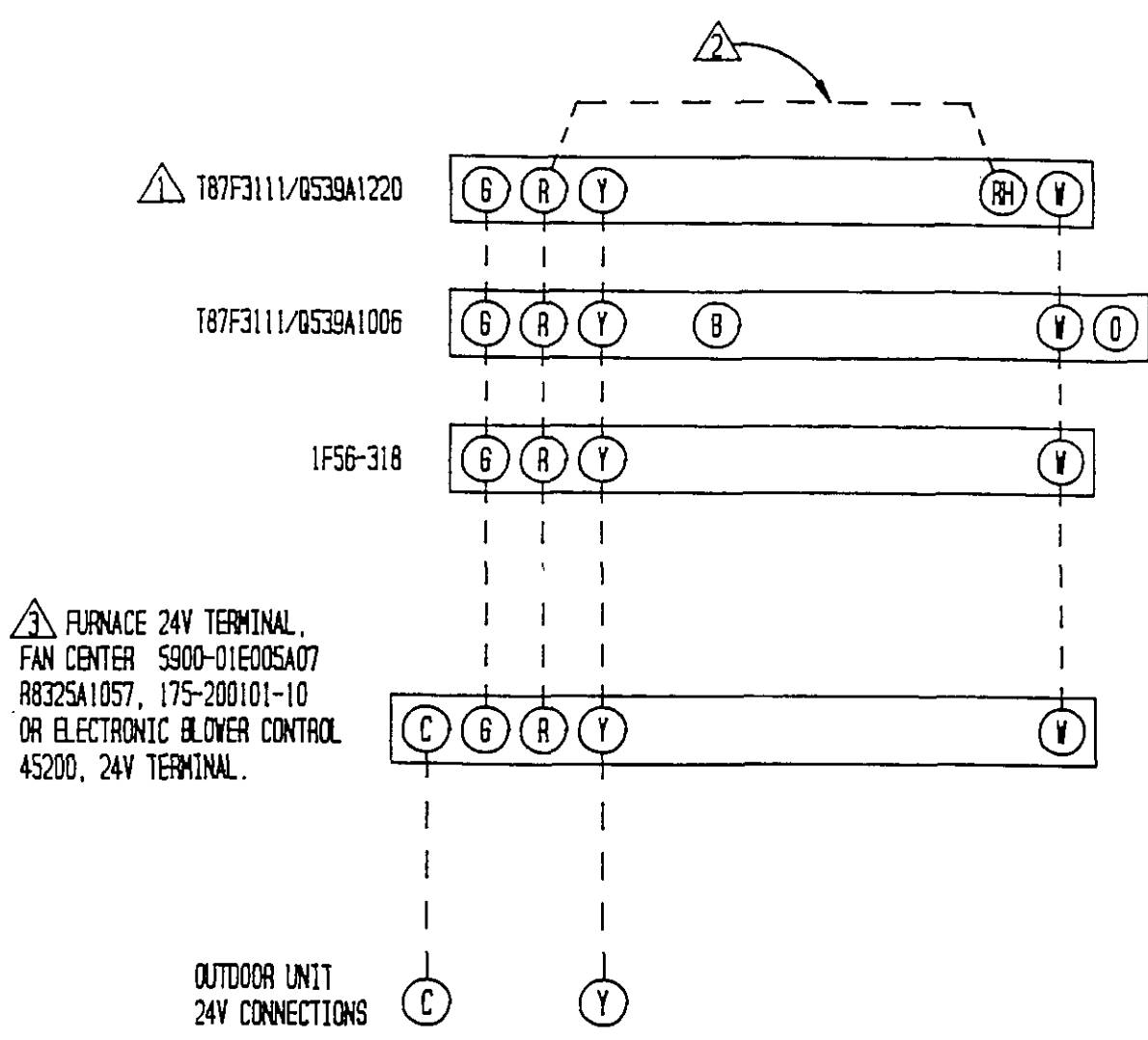

- △ SET ADJUST HEAT ANTICIPATOR (SEE FURNACE INSTALLATION INSTRUCTIONS)
- △ INSTALL JUMPER R-RH
- △ IF THE FURNACE IS NOT INTERNALLY WIRED FOR ADD ON AIR CONDITIONING, A FAN CENTER WILL NEED TO BE ADDED.

	FACTORY WIRING	FIELD WIRING
LOW VOLTAGE	_____	-----
HIGH VOLTAGE	—————	-----

AIR CONDITIONER W/GAS FURNACE

⚠ T87F3111/Q539A1220

⚠ FURNACE 24V TERMINAL
 FAN CENTER 5900-01E005A07
 R8325A1057, 175-200101-10
 OR ELECTRONIC BLOWER CONTROL
 45200, 24V TERMINAL.

OUTDOOR UNIT
 24V CONNECTIONS

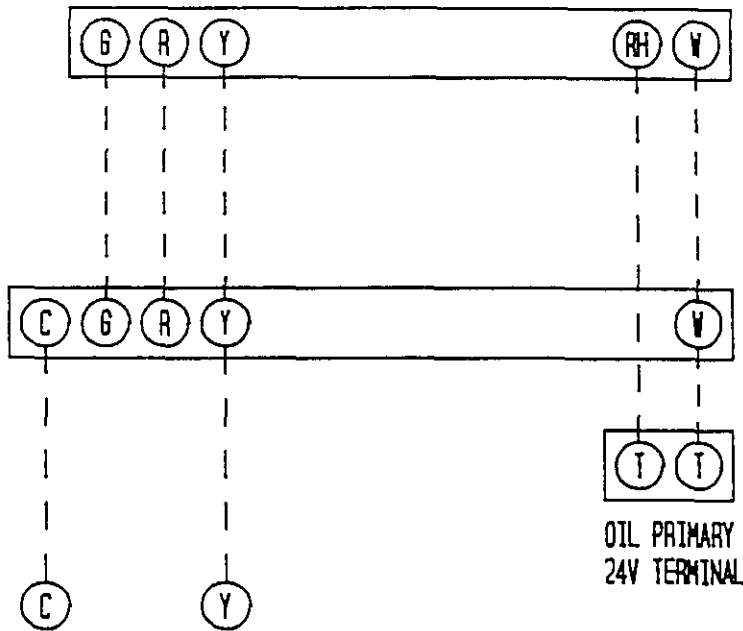

⚠ SET ADJUST HEAT ANTICIPATOR (SEE FURNACE INSTALLATION INSTRUCTIONS)

⚠ IF THE FURNACE IS NOT INTERNALLY WIRED FOR ADD ON AIR CONDITIONING, A FAN CENTER WILL NEED TO BE ADDED.

	FACTORY WIRING	FIELD WIRING
LOW VOLTAGE	_____	-----
HIGH VOLTAGE	=====	-----

AIR CONDITIONER W/OIL FURNACE

WALL THERMOSTATS

The following wall thermostats and subbases should be used as indicated, depending on the application.

TABLE 9

AIR CONDITIONING THERMOSTATS	
Model No.	Description
T87F3111	THERMOSTAT--1 stg. heat, adj. heater, Mercury
Q539A1220	SUBBASE --System Heat-Off-Cool Fan: On-Auto
ID51-605	THERMOSTAT--1 stg. cool, System w/Off Sw. Snap Action Fan: Auto-On
IF56-318	THERMOSTAT--1 st. cool, 1 stg. heat, Adj. heater Mercury System: Heat-Off-Cool Fan: Auto-On
T874C1000	THERMOSTAT--1 stg. cool, 2 stg. heat, Adj. heater, Mercury
Q674A1001	SUBBASE --System: Heat-Auto-Cool Fan: Auto-On

III. CHARGING INSTRUCTIONS

PRESSURE SERVICE PORTS

High and low pressure service ports are installed on all units so that the system operating pressures can be observed. Pressure tables can be found later in the manual covering all models. It is imperative to match the correct pressure table to the unit by model number.

TABLE 10

CHARGED TUBING (For Use With "Q" Versions)					
Model No.	Stub Tube	15'	25'	35'	45'
24UACQ 30UACQ 36UACQ	3/8" & 3/4"	3/8" & 5/8"	3/8" & 3/4"	3/8" & 3/4"	3/8" & 3/4"
42UACQ 48UACQ 60UACQ	3/8" & 7/8"	3/8" & 7/8"	3/8" & 7/8"	3/8" & 7/8"	3/8" & 7/8"

SYSTEM START-UP

STEP 1--Close disconnect switch(es) and set the thermostat to cool and the temperature to the highest setting.

STEP 2--Check for proper airflow across the indoor coil by referring to indoor unit installation instructions.

STEP 3--Connect the service gauges and allow the unit to run for at least 10 minutes or until pressures are stable. Check pressures to the system pressure table attached to the outdoor unit service panel. For optimum system performance, go to Step 4.

STEP 4--Install a thermometer on the suction line approximately 6" to 10" from the compressor. Optimum system performance will occur with a refrigerant charge resulting in a suction line superheat as determined from the following calculations.

- A. Measure indoor air wet bulb temperature _____ °F
- B. Measure outdoor air dry bulb temperature _____ °F
- C. Measure suction pressure _____ PSIG
- D. Measure suction line temperature _____ °F
- E. Determine optimum system superheat from Table 12 using outdoor air dry bulb (Step B) and indoor air wet bulb (Step A). _____ °F
- F. Determine saturated suction temperature from suction pressure using Table 11. _____ °F
- G. Determine system superheat:
 Suction line temperature (Step D) _____ °F
 - Saturated suction temperature (Step F) - _____ °F
 = System superheat = _____ °F
- H. Adjust the system superheat (Step G) to the optimum system superheat (Step E) by adding charge to lower the superheat or removing charge to raise the superheat.
- I. Check final system operating pressures to the system pressure tables as was done in Step 3.

TABLE 11 SATURATED SUCTION TEMPERATURE (R-22)

Suction Pressure PSIG	Saturated Suction Temperature (Deg. F)
50	26
53	28
55	30
58	32
61	34
63	36
65	38
67	39
70	41
73	43
76	45
79	47
82	49
86	51

TABLE 12 SYSTEM SUPERHEAT

Outdoor Ambient Temperature (Deg. F Dry Bulb)	Return Air Temperature Deg. F--Wet Bulb			
	59	63	67	71
105	1	1	5	
95	1	3	(8)	20
90	1	7	14	26
85	3	9	19	33
80	8	14	25	39
75	10	20	30	42

TABLE 13

TOTAL SYSTEM OPERATING CHARGE (Includes charge for the basic outdoor unit, indoor coil and 25' of interconnecting tubing)		
Outdoor Section	Indoor Section	Total R-22 Charge (Oz.)
24UAC*B	A30AQ-B	73
	A30A*-A	73
	BC24B	76
	3HCQ1	65
30UAC*A	A30A*-A	88
	BC35B	85
	BC36B	104
36UAC*A 36UACSA-B	A36AQ-B	96
	A36A*-A	96
	4HCQ	106
	BC36B	106
42UAC*B 42UACSA-B	A42A*-A	117
	BC48B	145
48UAC*B 48UACSA-B	A48A*-A	150
	BC48B	203
	BC60B	220
60UAC*A	A48A*-A	208
60UACSA-B	A48A*-A	185

The above includes 25' of 3/8" diameter liquid line. For other than 25' and other tube sizes, adjust the total charge according to the following schedule.

<u>Liquid Line Diameter</u>	<u>Oz. R-22 Per Ft.</u>
3/8"	.6
1/2"	1.2

INSTALLER NOTE: Stamp or mark the final system charge determined above on the outdoor unit serial plate.

Examples: 36UAC*A and A36A*-A with 35' liquid line
 $35' - 25' = 10' \times .6 = 6 \text{ oz.}$ $96 + 6 = 102 \text{ oz. Total}$

36UAC*A and A36A*-A with 18' liquid line
 $25' - 18' = 7' \times .6 = 4.2 \text{ oz.}$ $96 - 4 = 92 \text{ oz. Total}$

NOTE: Round all decimals to nearest whole number.

IV. SERVICE

SERVICE HINTS

1. Caution homeowner to maintain clean air filters at all times. Also, not to needlessly close off supply and return air registers. This reduces air flow through the system, which shortens equipment service life as well as increasing operating costs.
2. Check all power fuses or circuit breakers to be sure that they are the correct rating.
3. Periodic cleaning of the outdoor coil to permit full and unrestricted air flow circulation is essential.

FAN BLADE SETTING DIMENSIONS

Shown in the drawing below are the correct fan blade setting dimensions for proper air delivery across the outdoor coil.

Any service work requiring removal or adjustment in the fan and/or motor area will require that the dimensions below be checked and blade adjusted in or out on the motor shaft accordingly.

FIGURE 6

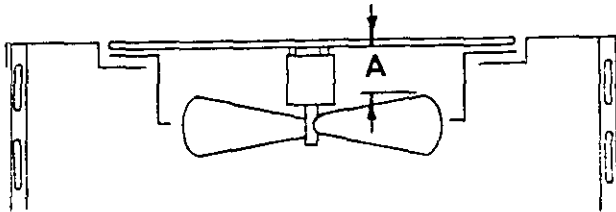
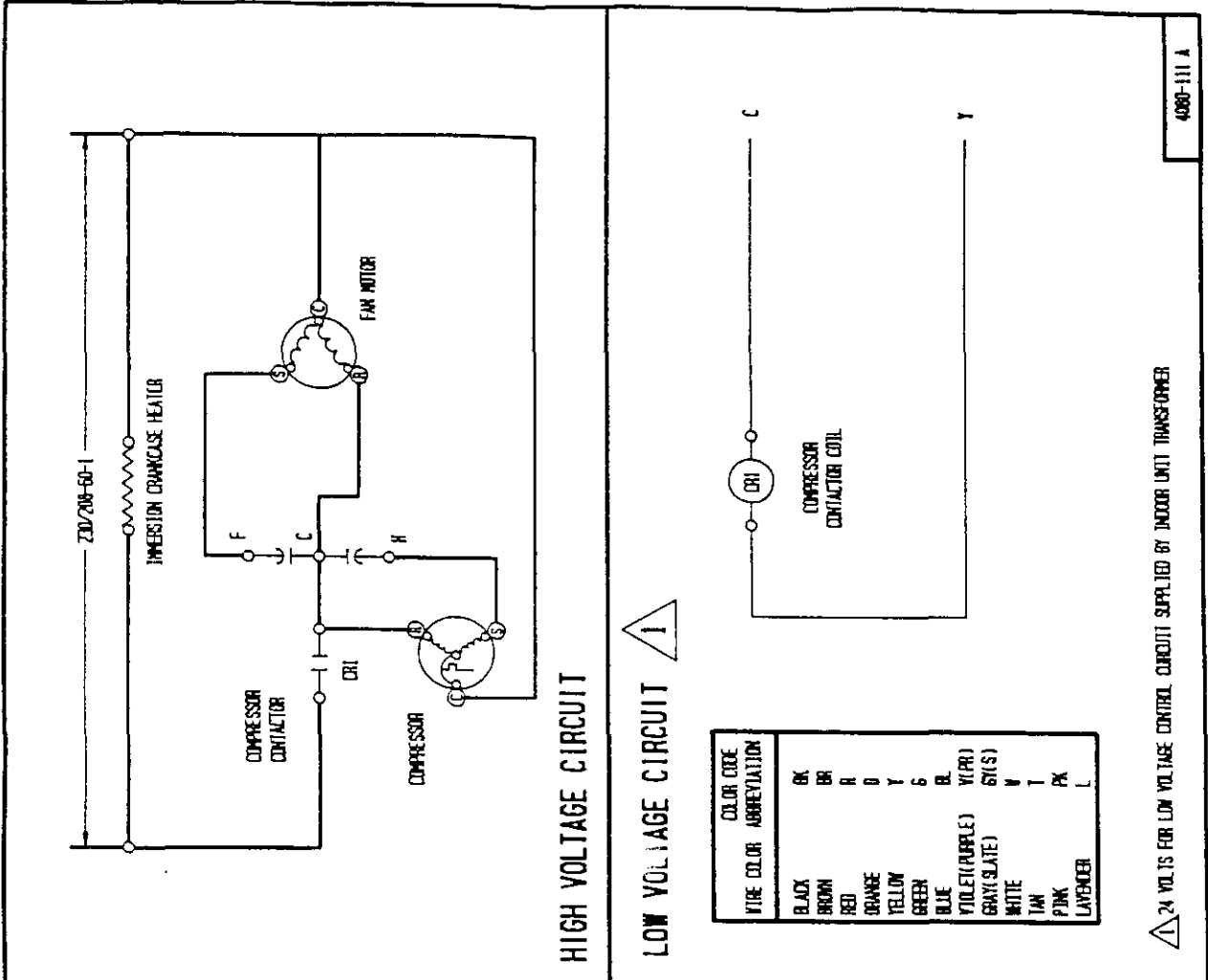
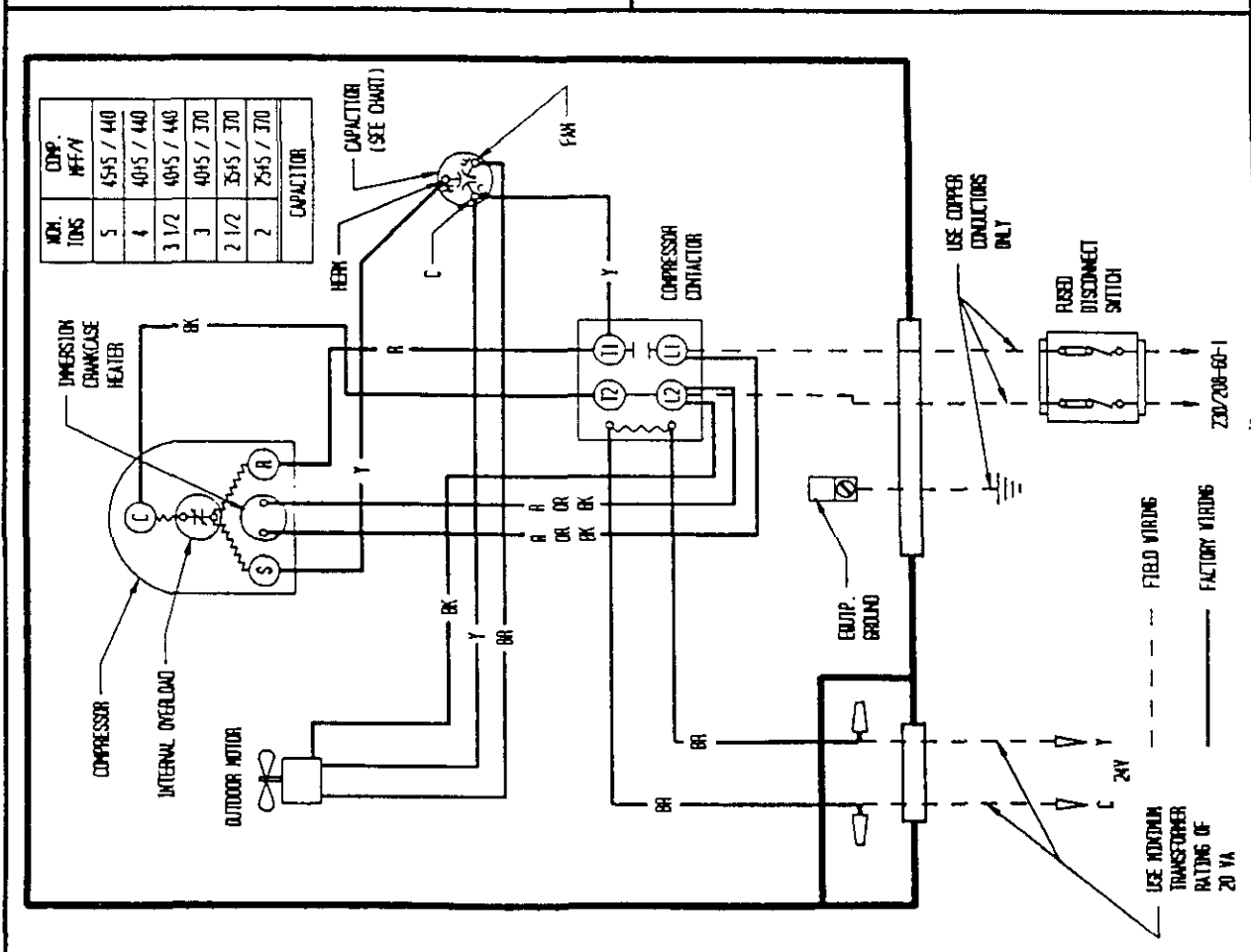
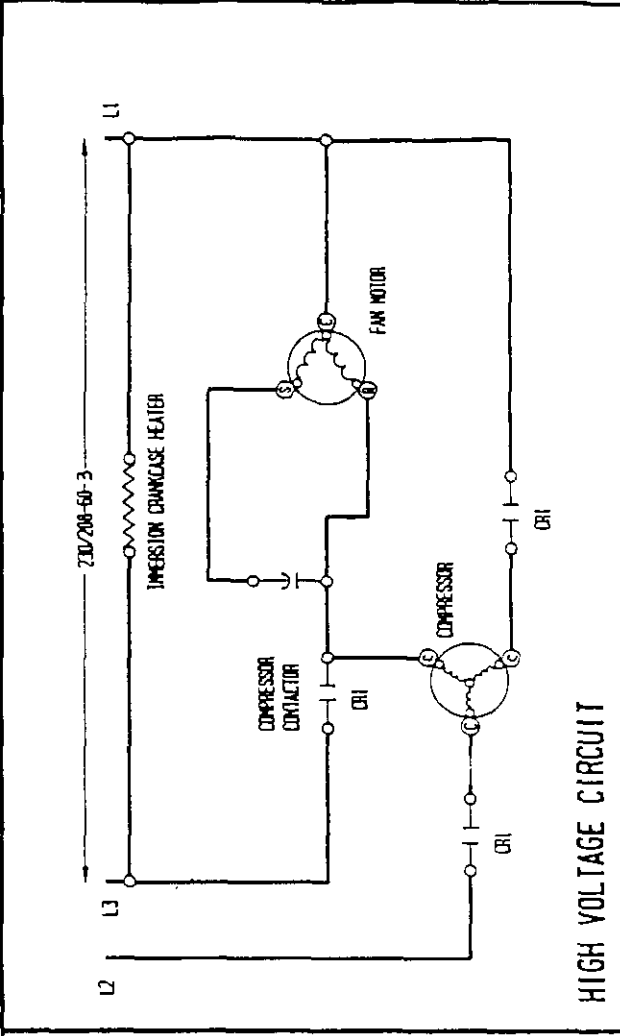

TABLE 14

Model	Dimension A
24, 30, 36 UAC	3-1/2
42, 48, 60UAC	4





HIGH VOLTAGE CIRCUIT

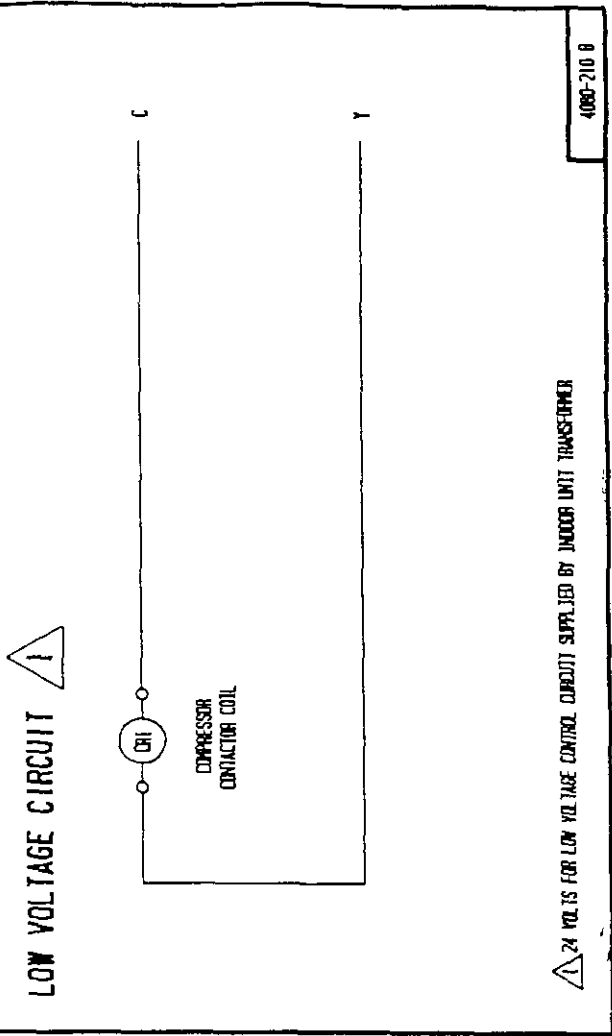

LOW VOLTAGE CIRCUIT

△ 24 VOLTS FOR LOW VOLTAGE CONTROL CIRCUIT SUPPLIED BY INDOOR UNIT TRANSFORMER

408P-210 B

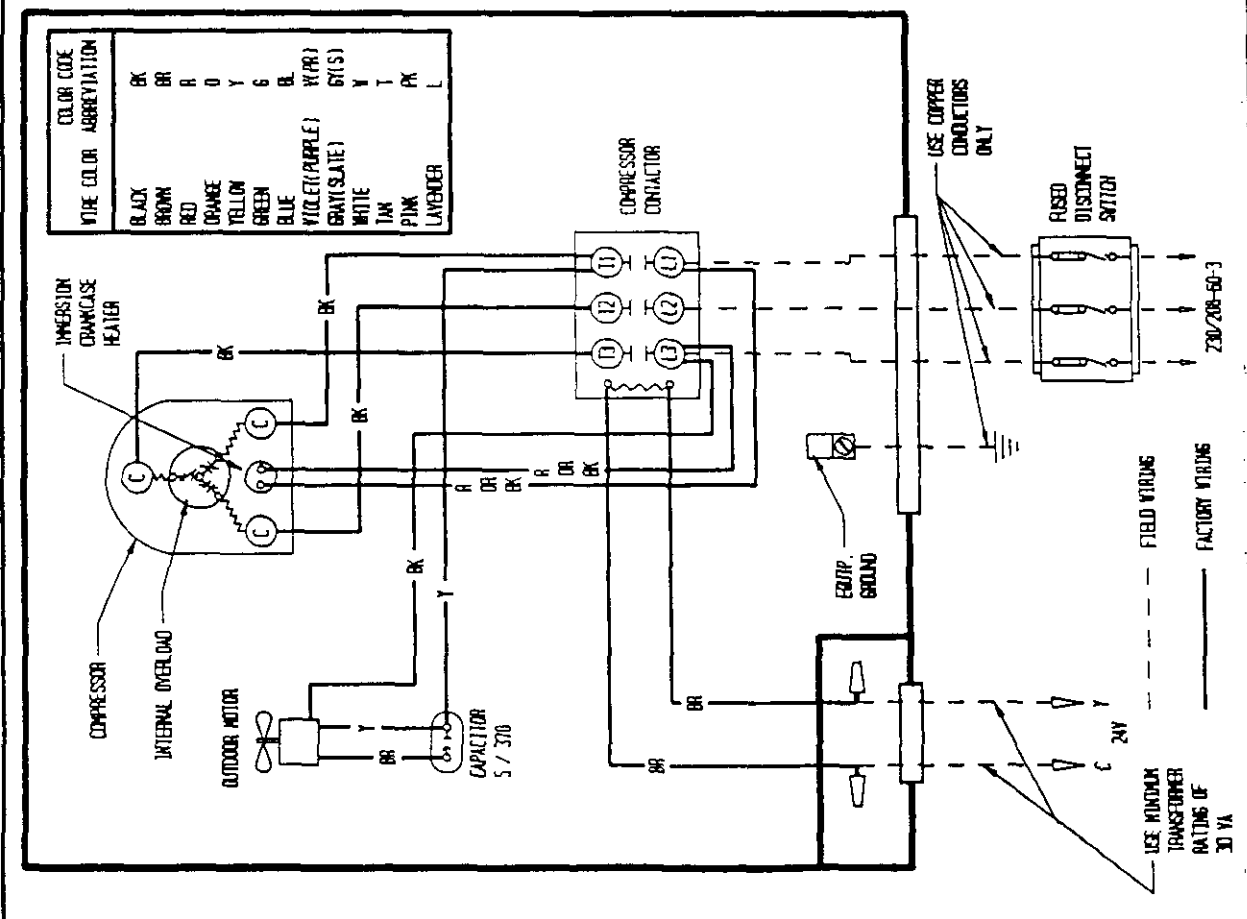

24UACQB
24UACSB

TABLE 15
Air Temperature Entering Outdoor Coil Degree F

COOLING

Model	Return Air Temperature	Pressure	°	°	°	°	°	°	°	°	°
			75	80	85	90	95	100	105	110	115
A18AQ-A, A18AS-A Rated CFM 750	75 deg. DB	Low Side	63	65	67	69	71	73	74	76	77
	62 deg. WB	High Side	165	178	192	206	222	237	254	271	289
	80 deg. DB	Low Side	67	70	72	74	76	77	79	80	82
	67 deg. WB	High Side	169	183	197	212	228	244	261	278	297
	85 deg. DB	Low Side	72	74	77	79	82	83	85	86	88
	72 deg. WB	High Side	176	190	204	220	236	252	270	288	307
A30AQ-A, A30AS-A A30AQ-B Rated CFM 825	75 deg. DB	Low Side	69	72	74	76	78	79	80	82	83
	62 deg. WB	High Side	176	189	203	217	233	248	265	282	301
	80 deg. DB	Low Side	73	76	79	81	84	85	87	88	89
	67 deg. WB	High Side	181	194	208	223	239	255	272	290	309
	85 deg. DB	Low Side	80	82	85	87	90	91	93	94	95
	72 deg. WB	High Side	187	201	215	230	247	263	281	300	320
3HCQ1 Rated CFM 800	75 deg. DB	Low Side	69	71	73	75	77	78	80	82	84
	62 deg. WB	High Side	162	176	190	205	221	236	252	269	286
	80 deg. DB	Low Side	73	75	78	80	83	85	86	88	90
	67 deg. WB	High Side	166	181	196	211	227	242	259	275	293
	85 deg. DB	Low Side	79	81	84	86	89	91	92	94	96
	72 deg. WB	High Side	176	190	204	219	235	251	267	285	303
BC24B Rated CFM 800	75 deg. DB	Low Side	73	75	77	78	80	81	82	83	84
	62 deg. WB	High Side	175	188	202	216	232	247	263	280	298
	80 deg. DB	Low Side	77	80	82	84	86	87	88	89	90
	67 deg. WB	High Side	179	193	207	222	238	254	270	286	306
	85 deg. DB	Low Side	83	86	88	90	92	93	94	96	97
	72 deg. WB	High Side	186	200	214	230	246	262	280	298	317

Low side pressure \pm 2 PSIG (suction line @ outdoor unit quick connect)
High side pressure \pm 5 PSIG (liquid line @ outdoor unit quick connect)

Tables are based upon rated CFM (airflow) across the evaporator coil and should be found under section titled "Refrigerant Charge" elsewhere in manual. If there is any doubt as to correct operating charge being in the system, the charge should be removed, system evacuated, and recharged to serial plate instructions.

30UACQA
30UACSA

TABLE 16
Air Temperature Entering Outdoor Coil Degree F

COOLING

Model	Return Air Temperature	Pressure	°	°	°	°	°	°	°	°	°
			75	80	85	90	95	100	105	110	115
A30AQ-A, A30AS-A Rated CFM 1000	75 deg. DB	Low Side	66	68	70	72	74	75	78	80	82
	62 deg. WB	High Side	182	197	212	227	242	257	272	287	302
	80 deg. DB	Low Side	71	73	75	77	79	81	83	85	87
	67 deg. WB	High Side	186	202	217	233	248	263	279	294	310
	85 deg. DB	Low Side	77	79	81	83	85	87	89	91	93
	72 deg. WB	High Side	192	209	225	241	257	273	289	305	322
3BCQ1 Rated CFM 1000	75 deg. DB	Low Side	66	68	70	72	74	76	78	80	82
	62 deg. WB	High Side	174	190	205	221	236	251	267	282	298
	80 deg. DB	Low Side	71	73	75	77	79	81	83	85	87
	67 deg. WB	High Side	179	195	210	226	242	258	274	289	305
	85 deg. DB	Low Side	77	79	81	83	85	87	89	91	93
	72 deg. WB	High Side	185	202	218	234	250	266	282	298	315
B36EHQ1/ BC35B Rated CFM 1025	75 deg. DB	Low Side	65	67	69	71	73	75	77	79	81
	62 deg. WB	High Side	175	189	204	218	233	248	262	277	291
	80 deg. DB	Low Side	70	72	74	76	78	80	82	84	86
	67 deg. WB	High Side	179	194	209	224	239	254	269	284	299
	85 deg. DB	Low Side	73	76	79	81	84	87	89	92	95
	72 deg. WB	High Side	185	201	216	231	247	262	278	293	309
BC30B Rated CFM 840	75 deg. DB	Low Side	64	67	70	72	74	76	77	78	79
	62 deg. WB	High Side	185	198	213	227	243	259	276	294	312
	80 deg. DB	Low Side	69	72	75	77	79	81	82	84	85
	67 deg. WB	High Side	188	203	218	250	250	267	284	302	320
	85 deg. DB	Low Side	73	77	80	83	85	87	89	90	91
	72 deg. WB	High Side	194	210	226	242	259	276	294	312	331
BC36B Rated CFM 1050	75 deg. DB	Low Side	69	71	73	75	77	79	80	82	83
	62 deg. WB	High Side	186	201	216	231	247	263	279	296	313
	80 deg. DB	Low Side	74	76	78	80	82	84	86	87	89
	67 deg. WB	High Side	190	222	238	238	254	271	287	305	322
	85 deg. DB	Low Side	80	82	84	86	88	90	92	94	96
	72 deg. WB	High Side	196	212	229	246	263	280	298	315	333

Low side pressure + 2 PSIG (suction line @ outdoor unit quick connect)

High side pressure + 5 PSIG (liquid line @ outdoor unit quick connect)

Tables are based upon rated CFM (airflow) across the evaporator coil and should be found under section titled "Refrigerant Charge" elsewhere in manual. If there is any doubt as to correct operating charge being in the system, the charge should be removed, system evacuated, and recharged to serial plate instructions.

TABLE 17
Air Temperature Entering Outdoor Coil Degree F

Model	Return Air Temperature	Pressure	°	°	°	°	°	°	°	°	°
			75	80	85	90	95	100	105	110	115
A30AQ-A, A30AS-A Rated CFM 1125	75 deg. DB	Low Side	59	61	63	66	68	70	73	75	77
	62 deg. WB	High Side	176	190	203	217	230	243	257	270	284
	80 deg. DB	Low Side	62	65	68	70	73	76	78	81	84
	67 deg. WB	High Side	181	194	208	222	236	250	264	278	291
A36AQ-A, A36AS-A A36AQ-B Rated CFM 1200	75 deg. DB	Low Side	64	66	68	71	73	75	78	80	82
	62 deg. WB	High Side	177	194	210	226	242	258	274	290	307
	80 deg. DB	Low Side	69	71	73	76	78	80	83	85	87
	67 deg. WB	High Side	183	200	216	232	248	264	280	296	313
A42AQ-A, A42AS-A Rated CFM 1380	75 deg. DB	Low Side	63	66	69	71	74	77	79	82	85
	62 deg. WB	High Side	193	206	219	231	244	257	269	282	295
	80 deg. DB	Low Side	68	71	74	76	79	82	84	87	90
	67 deg. WB	High Side	198	211	222	237	250	263	276	289	302
A48AQ-A, A48AS-A Rated CFM 1450	75 deg. DB	Low Side	69	71	73	76	78	80	83	85	87
	62 deg. WB	High Side	199	213	222	242	257	272	286	301	315
	80 deg. DB	Low Side	75	77	79	82	84	86	89	91	93
	67 deg. WB	High Side	204	219	233	249	264	279	294	309	324
B36EQ1/ BC35B Rated CFM 1200	75 deg. DB	Low Side	58	61	64	66	69	72	74	77	80
	62 deg. WB	High Side	183	196	211	224	238	252	266	280	293
	80 deg. DB	Low Side	63	66	69	71	74	77	79	82	85
	67 deg. WB	High Side	187	201	211	230	244	258	272	287	301
3HCQ1 Rated CFM 950	75 deg. DB	Low Side	55	58	61	63	66	69	71	74	77
	62 deg. WB	High Side	178	192	202	221	236	251	265	280	294
	80 deg. DB	Low Side	59	62	65	68	71	74	77	80	83
	67 deg. WB	High Side	182	197	211	227	242	257	272	287	302
4HCQ Rated CFM 1300	75 deg. DB	Low Side	63	66	69	71	74	77	79	82	85
	62 deg. WB	High Side	194	206	211	230	242	254	266	278	290
	80 deg. DB	Low Side	68	71	74	76	79	82	84	87	90
	67 deg. WB	High Side	198	211	222	236	249	262	274	287	300
BC36B Rated CFM 1200	75 deg. DB	Low Side	63	65	67	70	72	74	77	79	81
	62 deg. WB	High Side	175	189	202	218	233	248	262	277	291
	80 deg. DB	Low Side	68	70	72	75	77	79	82	84	86
	67 deg. WB	High Side	179	194	202	224	239	254	269	284	299
	85 deg. DB	Low Side	72	75	78	80	83	86	88	91	94
	72 deg. WB	High Side	185	201	216	232	247	262	278	293	309

Low side pressure + 2 PSIG (suction line @ outdoor unit quick connect)
High side pressure + 5 PSIG (liquid line @ outdoor unit quick connect)

Tables are based upon rated CFM (airflow) across the evaporator coil and should be found under section titled "Refrigerant Charge" elsewhere in manual. If there is any doubt as to correct operating charge being in the system, the charge should be removed, system evacuated, and recharged to serial plate instructions.

42UACQB
42UACSB

TABLE 18

COOLING

Air Temperature Entering Outdoor Coil Degree F

Model	Return Air Temperature	Pressure	Air Temperature Entering Outdoor Coil Degree F								
			75	80	85	90	95	100	105	110	115
A42AQ-A, A42AS-A Rated CFM 1325	75 deg. DB	Low Side	63	66	69	71	73	75	76	77	78
	62 deg. WB	High Side	174	189	204	220	236	252	269	286	304
	80 deg. DB	Low Side	68	71	74	76	78	80	81	83	84
	67 deg. WB	High Side	177	194	210	226	243	260	277	294	312
	85 deg. DB	Low Side	72	76	79	82	84	86	88	89	90
	72 deg. WB	High Side	184	200	217	234	251	269	286	305	323
BC48B Rated CFM 1550	75 deg. DB	Low Side	64	69	72	75	77	78	79	79	79
	62 deg. WB	High Side	175	193	210	226	243	259	274	288	304
	80 deg. DB	Low Side	70	74	77	80	82	84	85	85	85
	67 deg. WB	High Side	180	198	215	232	249	265	281	296	310
	85 deg. DB	Low Side	76	80	83	86	88	90	91	91	91
	72 deg. WB	High Side	186	205	223	241	258	275	291	306	321

Low side pressure \pm 2 PSIG (suction line @ outdoor unit quick connect)

High side pressure \pm 5 PSIG (liquid line @ outdoor unit quick connect)

Tables are based upon rated CFM (airflow) across the evaporator coil and should be found under section titled "Refrigerant Charge" elsewhere in manual. If there is any doubt as to correct operating charge being in the system, the charge should be removed, system evacuated, and recharged to serial plate instructions.

TABLE 19

COOLING

Air Temperature Entering Outdoor Coil Degree F

Model	Return Air Temperature	Pressure	Air Temperature Entering Outdoor Coil Degree F								
			75	80	85	90	95	100	105	110	115
A48AQ-A, A48AS-A Rated CFM 1500	75 deg. DB	Low Side	67	70	73	75	77	79	80	81	81
	62 deg. WB	High Side	182	198	213	229	244	259	274	289	303
	80 deg. DB	Low Side	72	75	78	80	82	84	85	86	87
	67 deg. WB	High Side	186	203	219	234	250	265	281	296	311
	85 deg. DB	Low Side	78	81	84	86	88	90	91	92	93
	72 deg. WB	High Side	193	210	226	242	258	274	290	306	322
BC48B Rated CFM 1700	75 deg. DB	Low Side	65	68	71	73	75	77	78	79	79
	62 deg. WB	High Side	179	198	216	233	249	265	280	294	308
	80 deg. DB	Low Side	70	73	76	78	80	82	83	84	85
	67 deg. WB	High Side	186	204	221	238	255	271	287	302	316
	85 deg. DB	Low Side	74	78	81	84	86	88	89	90	91
	72 deg. WB	High Side	192	211	229	247	264	281	297	312	327
BC60B Rated CFM 1700	75 deg. DB	Low Side	73	74	76	78	79	80	82	83	84
	62 deg. WB	High Side	187	204	221	238	254	270	285	300	314
	80 deg. DB	Low Side	77	79	81	83	85	87	88	89	90
	67 deg. WB	High Side	192	210	227	244	261	277	293	308	322
	85 deg. DB	Low Side	83	85	87	89	91	93	94	95	96
	72 deg. WB	High Side	199	218	236	253	270	286	302	318	333

Low side pressure + 2 PSIG (suction line @ outdoor unit quick connect)

High side pressure + 5 PSIG (liquid line @ outdoor unit quick connect)

Tables are based upon rated CFM (airflow) across the evaporator coil and should be found under section titled "Refrigerant Charge" elsewhere in manual. If there is any doubt as to correct operating charge being in the system, the charge should be removed, system evacuated, and recharged to serial plate instructions.

60UACQA
60UACSA

TABLE 20
Air Temperature Entering Outdoor Coil Degree F

COOLING

Model	Return Air Temperature	Pressure	°	°	°	°	°	°	°	°	°
			75	80	85	90	95	100	105	110	115
A48AQ-A. A48AS-A Rated CFM 1500	75 deg. DB	Low Side	61	62	64	65	67	69	70	72	73
	62 deg. WB	High Side	168	182	197	210	225	239	253	268	282
	80 deg. DB	Low Side	66	67	69	70	72	74	75	77	78
	67 deg. WB	High Side	173	187	202	216	231	246	260	275	289
A60AQ-A. A60AS-A Rated CFM 1900	85 deg. DB	Low Side	71	72	74	75	77	79	80	82	83
	72 deg. WB	High Side	177	193	208	234	239	254	270	285	301
	75 deg. DB	Low Side	64	66	68	71	73	75	78	80	82
	62 deg. WB	High Side	173	188	203	218	233	248	263	278	293
5HCQ Rated CFM 1600	80 deg. DB	Low Side	69	71	73	76	78	80	83	85	87
	67 deg. WB	High Side	177	193	208	224	239	254	270	285	301
	85 deg. DB	Low Side	73	76	79	81	84	87	89	92	95
	72 deg. WB	High Side	184	200	215	231	247	263	279	294	310
BC48A Rated CFM 1625	75 deg. DB	Low Side	58	60	62	65	67	69	72	74	76
	62 deg. WB	High Side	179	195	210	226	242	258	274	289	305
	80 deg. DB	Low Side	61	64	67	69	72	75	77	80	83
	67 deg. WB	High Side	183	200	216	232	248	264	280	296	313
BC60A Rated CFM 1800	85 deg. DB	Low Side	66	69	72	74	77	80	82	85	88
	72 deg. WB	High Side	189	206	223	240	257	274	291	308	325
	75 deg. DB	Low Side	58	62	64	67	69	71	74	76	78
	62 deg. WB	High Side	184	200	217	233	250	267	283	300	316
BC60A Rated CFM 1800	80 deg. DB	Low Side	65	67	69	72	74	76	79	81	83
	67 deg. WB	High Side	188	205	222	239	256	273	290	307	324
	85 deg. DB	Low Side	69	72	75	77	80	83	85	88	91
	72 deg. WB	High Side	194	212	230	247	265	283	300	318	336
BC60A Rated CFM 1800	75 deg. DB	Low Side	61	64	67	69	72	75	77	80	83
	62 deg. WB	High Side	185	201	216	232	247	262	278	293	309
	80 deg. DB	Low Side	66	69	72	74	77	80	82	85	88
	67 deg. WB	High Side	189	206	222	238	254	270	286	302	319
BC60A Rated CFM 1800	85 deg. DB	Low Side	71	74	77	80	83	86	89	92	95
	72 deg. WB	High Side	195	212	229	246	263	280	297	314	331

Low side pressure + 2 PSIG (suction line @ outdoor unit quick connect)
High side pressure + 5 PSIG (liquid line @ outdoor unit quick connect)

Tables are based upon rated CFM (airflow) across the evaporator coil and should be found under section titled "Refrigerant Charge" elsewhere in manual. If there is any doubt as to correct operating charge being in the system, the charge should be removed, system evacuated, and recharged to serial plate instructions.

