

# INSTALLATION INSTRUCTIONS

## OIL FURNACE

### MODELS:

**FH085D36B**

**FH110D48B**

**FH110D60B**

**FLF085D36A**

**FLR085D36A**

**FLF110D48A**

**FLR110D48A**

**FLR140D60A**

**FC085D36A**

#### FOR YOUR SAFETY

Do not store or use gasoline or other flammable vapors and liquids in the vicinity of this or any other appliance.

#### CAUTION

READ ALL INSTRUCTIONS CAREFULLY BEFORE INSTALLING

MANUAL 2100-164 REV. G  
SUPERSEDES REV. F  
FILE VOL. I, TAB 3

## GETTING OTHER INFORMATION AND PUBLICATIONS

These publications can help you install the furnace. You can usually find these at your local library or purchase them directly from the publisher. Be sure to consult current edition of each standard.

National Fuel Gas Code	-ANSI Z223.1/NFPA 54
National Electrical Code	-ANSI/NFPA 70
Standard For The Installation Of Air Conditioning and Ventilating Systems	-ANSI/NFPA 90A
Standard For Warm Air Heating and Air Conditioning Systems	-ANSI/NFPA 90B
Standard For Installation Of Oil Burning Equipment	-ANSI/NFPA 31
Standard For Chimneys, Fireplaces, Vents, and Solid Fuel Burning Appliances	-NFPA 211
Load Calculation For Residential Winter and Summer Air Conditioning	-ACCA Manual J
Duct Design For Residential Winter and Summer Air Conditioning and Equipment Selection	-ACCA Manual D

---

### FOR MORE INFORMATION, CONTACT THESE PUBLISHERS

- ACCA: AIR CONDITIONING CONTRACTORS OF AMERICA  
1513 16th Street NW  
Washington, DC 20036  
Telephone: (202) 483-9370  
Fax: (202) 234-4721
- ANSI: AMERICAN NATIONAL STANDARDS INSTITUTE  
1430 Broadway  
New York, NY 10018  
Telephone: (212) 354-3300
- ASHRAE: AMERICAN SOCIETY OF HEATING REFRIGERATING AND  
AIR CONDITIONING ENGINEERS, INCORPORATED  
1791 Tullie Circle, N.E.  
Atlanta, GA 30329-2305  
Telephone: (404) 636-8400  
Fax: (404) 321-5478
- NFPA: NATIONAL FIRE PROTECTION ASSOCIATION  
Batterymarch Park  
P. O. Box 9101  
Quincy, MA 02269-9901  
Telephone: (617) 770-3000

To order publications: (800) 344-3555

## TABLE OF CONTENTS

INSTALLATION AND OPERATING INSTRUCTIONS . . . . .	1
Equipment Selection . . . . .	1
Locating The Furnace. . . . .	1
Duct Work . . . . .	4
Installing The Furnace. . . . .	4
Wiring . . . . .	5
Oil Line Piping . . . . .	6
Oil Burner . . . . .	6
Burner Adjustment . . . . .	6
Checks and Adjustments . . . . .	7
Burner Nozzle and Electrode Adjustments . . . . .	7
Ventilation and Combustion Air . . . . .	9
A. Appliances Located In Confined Spaces . . . . .	9
B. Located In Confined Spaces . . . . .	10
C. All Air From Outdoors . . . . .	10
D. Louvers and Grilles . . . . .	12
Venting . . . . .	12
Thermostat . . . . .	12
Fan and Limit Control . . . . .	12
 MAINTENANCE . . . . .	 14
Lubrication . . . . .	14
Inspect Air Filter . . . . .	14
Final Inspection and Test . . . . .	14
 SERVICE HINTS . . . . .	 15
Common Causes of Trouble. . . . .	15
Care of Finish . . . . .	16
Cleaning of Furnace . . . . .	16
CFM Versus Static Pressure Curves . . . . .	17
Wiring Diagrams . . . . .	22
A-7000 Single Stage and B-8000 Two Stage Fuel Units . . . . .	25
Beckett Burner . . . . .	27

## FIGURES AND TABLES

Figure 1 . . . . .	2
Figure 2 . . . . .	2
Figure 3 . . . . .	3
Figure 4 . . . . .	5
Figure 5 . . . . .	7
Figure 6 . . . . .	9
Figure 7 . . . . .	11
Figure 8 . . . . .	11
Figure 9 . . . . .	11
 Table 1 . . . . .	 1
Table 2 . . . . .	2
Table 3 . . . . .	2
Table 4 . . . . .	3
Table 5 . . . . .	5
Table 6 . . . . .	6
Table 7 . . . . .	8
Table 8 . . . . .	9
Table 9 . . . . .	9
Table 10 . . . . .	10
Table 11 . . . . .	13

# INSTALLATION AND OPERATING INSTRUCTIONS FOR OIL FURNACES

## EQUIPMENT SELECTION

An accurate heating load calculation must be conducted using American Society of Heating, Refrigeration and Air Conditioning Engineers (ASHRAE) or Air Conditioning Contractors of American (ACCA) manuals. DO NOT add a large safety factor above the calculated value. If the calculated heating load requirement exceeds the heating capacity rating of a given model, use only the next larger size available. Never increase by any more than absolutely necessary based upon available equipment heating capacities. Always select based upon heat capacity (output), never use input capacities.

**NOTE:** It is the personal responsibility and obligation of the purchaser to contract a qualified installer to assure that installation is adequate and is in conformance with governing codes and ordinances.

## LOCATING THE FURNACE

When installing the furnace be sure to provide adequate space for easy service and maintenance. Locate the furnace as close to the chimney as practical, giving consideration to the accessibility of the oil burner, controls, and blower for service. Allow a minimum of 24 inches at front of furnace for servicing oil burner. Allow adequate room for filter and blower maintenance. Clearance from combustible material as stated on the furnace and repeated in Table 1 must be maintained. For damp basement installations, a raised concrete pad is recommended. This will help keep the bottom of the furnace dry and reduce rusting.

An oil burner must have a generous supply of combustion air to operate properly. The flow of combustion and ventilating air must not be obstructed from reaching the furnace. See "Ventilation and Combustion Air Section".

The furnace area must be kept clear and free of combustible materials, gasoline and other flammable vapors and liquids.

This unit is not designed for mobile home or trailer installations. Always install furnace in a level position.

**TABLE 1** **MINIMUM CLEARANCES--INCHES**

Model	Minimum Installation Clearances									Minimum (2) Ventilation Openings For Confined Spaces- Square Inches		
	Furnace			Plenum		(1)	Flue	Floor	Minimum Service Clearances			
	Front	Back	Sides	Top	Sides	Duct	Pipe		Front		Back	Sides
FHO85D36B	4	1	2	2	2	2	9	C	24	--	--	240
FH110D48B	4	1	2	2	2	2	9	C	24	--	--	280
FH110D60B	4	1	2	2	2	2	9	C	24	--	--	280
FLFO85D36A	6	0	2	2	2	2	9	NC	24	24	18*	290
FLRO85D36A	6	18	2	2	2	2	9	NC	24	24	18*	290
FLF110D48A	6	0	2	2	2	2	9	NC	24	24	18*	340
FLR110D48A	6	18	2	2	2	2	9	NC	24	24	18*	340
FLR140D60A	6	18	2	2	2	2	9	NC	24	24	18*	360
FCO85D36A	6	1	2	2	2	2	9	NC**	24	--	--	240

(1) For the first three feet from plenum. After 3 feet, no clearance required.

C - combustible flooring                      NC - non-combustible floor

\* Maintained on one side or the other to achieve filter access and/or blower service.

\*\* Floor must be non-combustible. Can be installed on combustible flooring only when installed on special base part No. CFB7 available from factory.

(2) See Page 10 for additional details on ventilation openings.

TABLE 2

## DIMENSIONS (Inches) LO-BOY MODELS

Model Number	Cabinet			Plenum Openings		Flue Connection				Air Filters (1)	
	A Width	B Depth	C Height	DxB Supply	DxF Return	Location	G Dia	H	J	Size	No. Used
FLP085D36A	23	47-1/4	40-1/4	22x20	22x16	Front	6	--	5-1/4	11-1/2x17	2
FLR085D36A	23	47-1/4	40-1/4	22x20	22x16	Rear	6	34	--	11-1/2x17	2
FLP110D48A	23	47-1/4	40-1/4	22x20	22x16	Front	6	--	5-1/4	10x20/13x20	1
FLR110D48A	23	47-1/4	40-1/4	22x20	22x16	Rear	6	34	--	10x20/13x20	1
FLR140D60A	26	50	48-7/8	25x20	25x16	Rear	6	42-3/8	2-7/8	13x20	2

(1) Permanent washable type filter 1" nom. thickness.

FIGURE 1

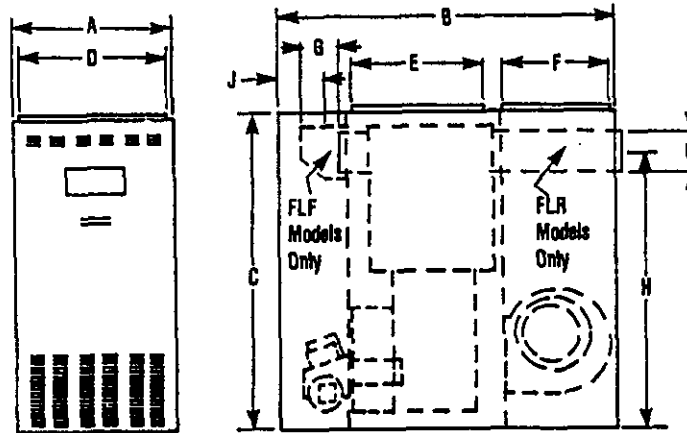

TABLE 3

## DIMENSIONS (Inches) HI-BOY MODELS

Model Number	Cabinet			Plenum Opening		G	(1) Filter Size
	A Width	B Depth	C Height	DxB Supply	FxF (2) Return	Flue Diameter	
FHO85D36B	23	31-1/2	56	22x20	23x14	6	16x25
FH110D48B	23	31-1/2	60	22x20	23x14	6	16x25
FH110D60B	23	31-1/2	60	22x20	23x14 (3)	6	16x25 (2 req'd)

(1) Permanent washable type filter.  
(2) Left or right side return air option. Must be cut-in by installer.  
(3) Use both left and right side openings.

FIGURE 2

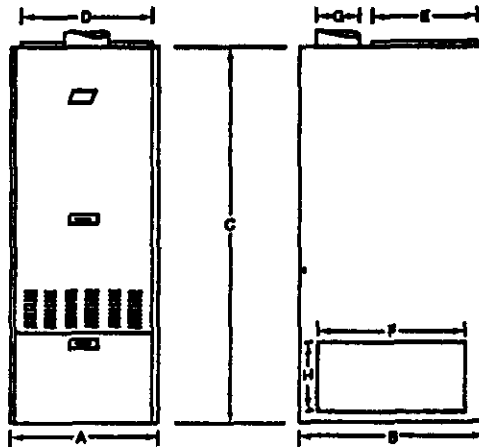
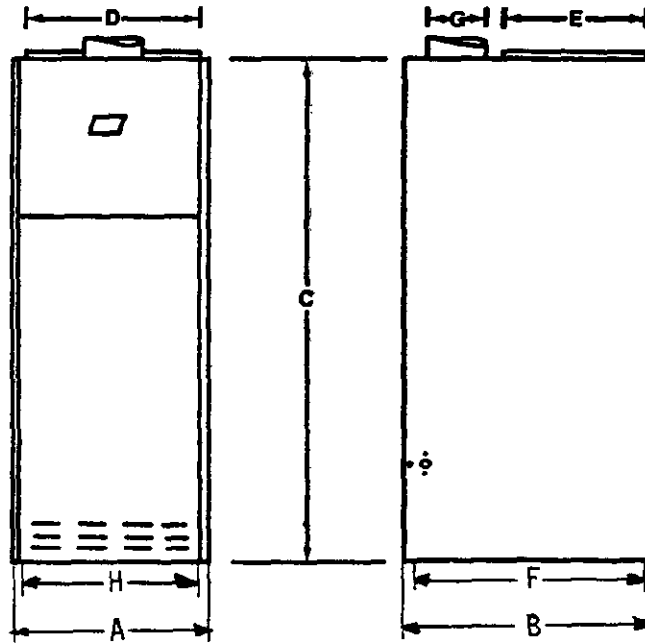

TABLE 4 DIMENSIONS (Inches) COUNTERFLOW MODELS

Model Number	Cabinet			Plenum Opening		G	(1) Filter Size
	A Width	B Depth	C Height	DxE Return	FxE Supply	Flue Diameter	
FC085D36A	23	29-1/2	56	22x20	18x19	6	10x20 (1) 15x20 (1)

(1) Permanent washable type filter.

FIGURE 3



## DUCT WORK

The air distribution system should be designed and installed in conformance with Manuals published by Air Conditioning Contractors of America (ACCA), as set forth in Manual D, or ASHRAE publications.

### CAUTION

When a furnace is installed so that supply ducts carry air circulated by the furnace to areas outside the space containing the furnace, the return air must also be handled by a duct(s) sealed to the furnace casing and terminating outside the space containing the furnace. This is to prevent drawing possible hazardous combustion products into the circulated air.

When the furnace is used in connection with a cooling unit\*, the furnace shall be installed parallel with or on the upstream side of the cooling unit to avoid condensation in the heating element. With a parallel flow arrangement, the dampers or other means used to control flow of air shall be adequate to prevent chilled air from entering the furnace, and if manually operated, must be equipped with means to prevent operation of either unit, unless the damper is in the full heat or cool position.

\*A cooling unit is an air conditioning coil, heat pump coil or chilled water coil.

See CFM versus static pressure curves on pages 17 - 21 for additional information.

**INADEQUATE SUPPLY AIR AND/OR RETURN AIR DUCT SYSTEMS.** Short cycling because of limit control operation can be created by incorrectly designed or installed supply and/or return air duct systems.

The duct systems must be designed using ASHRAE or ACCA design manuals and the equipment cfm and external static pressure ratings to insure proper air delivery capabilities.

On replacement installations, particularly if equipment is oversized, the duct systems can easily be undersized. Modifications may be required to assure that the equipment is operating within the approved temperature rise range when under full rated input conditions, and that no short cycling on limit controls is occurring.

## INSTALLING THE FURNACE

A typical installation is shown in Figure 4. All parts of the furnace installation (furnace, oil tank and piping systems, combustion and ventilation air, venting, etc.) must comply with NFPA31, Installation of Oil Burning Equipment--latest edition. This drawing shows the typical connecting parts needed to correctly install this furnace. Make sure that all parts of the heating system comply with the local codes.

Check the furnace and your load calculation to verify that the unit is properly sized. (Refer to "Equipment Selection" section on Page 1.)

The correct size of unit needed may be substantially smaller than the unit being replaced due to home improvements and technology advancements since the initial installation.

FIGURE 4  
TYPICAL INSTALLATION REQUIREMENTS  
FRONT FLUE LO-BOY MODEL SHOWN

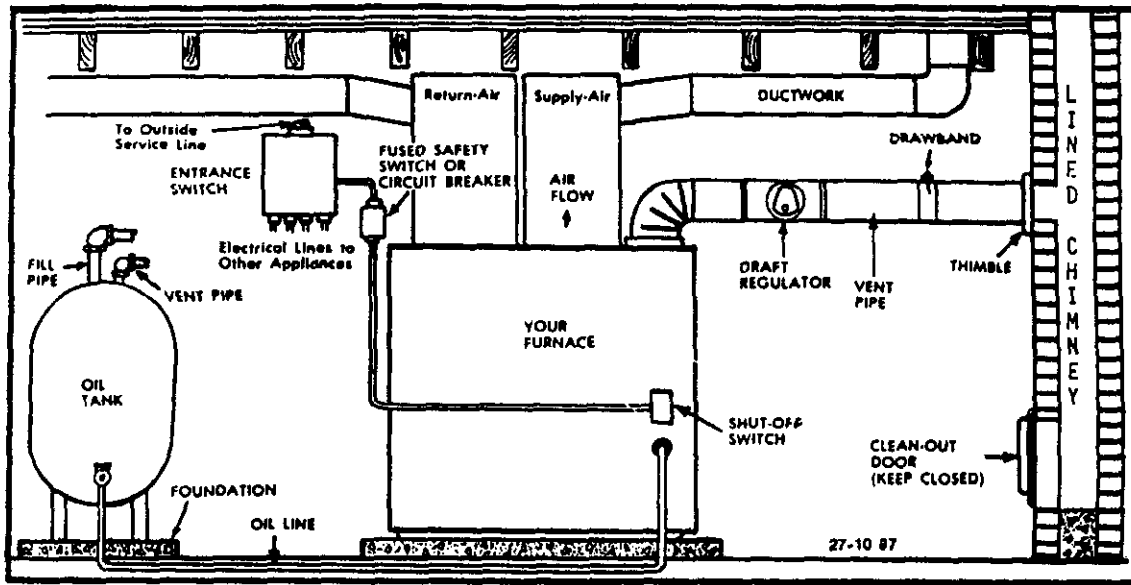

NOTE: The chimney must be lined with a high temperature noncorrosive material that complies with the local codes.

## WIRING

FACTORY--All units are fully factory wired. Multi-speed blowers are factory wired on high speed for cooling/manual fan operation. Heating speeds are wired for the largest input and may need lower speed for field installed low input nozzle. If replacement wire is necessary, use 105 degrees C minimum. See electrical data, Table 5.

FIELD--All wiring must conform to the National Electrical Code and all local codes. A separate fuse or breaker should be used for the furnace.

TABLE 5  
ELECTRICAL DATA

Model	Volts/Hz/PH	Total Amps	Blower Motor		Burner Motor		Minimum Circuit Ampacity	Max. Time Delay Fuse or HACR Circuit Breaker
			HP	FLA	HP	FLA		
FR085D36B	115/60/1	10	1/3	7.5	1/7	2.5	15	15
FR110D48B	115/60/1	13	1/2	10.5	1/7	2.5	16	20
FR110D60B	115/60/1	15	3/4	12.5	1/7	2.5	19	20
FLR085D36A	115/60/1	8.1	1/3	5.6	1/7	2.5	15	15
FLR085D36A	115/60/1	8.1	1/3	5.6	1/7	2.5	15	15
FLR110D48A	115/60/1	13	1/2	10.5	1/7	2.5	16	20
FLR110D48A	115/60/1	13	1/2	10.5	1/7	2.5	16	20
FLR140B60A	115/60/1	15	3/4	12.5	1/7	2.5	19	20
FC085D36A	115/60/1	8.1	1/3	5.6	1/7	2.5	15	15



## OIL LINE PIPING

First determine whether the pipe system is to be a single line system or a two line system. After determining the best piping system for the application, refer to the pump specifications on page 26. All connections must be absolutely air tight or you will have a malfunction of the burner. When installing the piping, a good oil filter should be installed close to the burner. A single line system is recommended for gravity feed.

A typical single inside tank installation is shown in Figure 4A. For installation details for this and other tank configurations, refer to NFPA31--latest edition. All tank and pipe set-ups must comply with NFPA31.

## OIL BURNER

All units are shipped with the oil burner installed, and with high rate oil nozzle installed designed for use with No. 1 or No. 2 fuel oil. Inspect firepot refractory before firing to be sure it has not been jarred out of position in shipment. Burner air tube must not extend beyond inside surface of firepot, preferable location is 1/8 inch from inside surface.

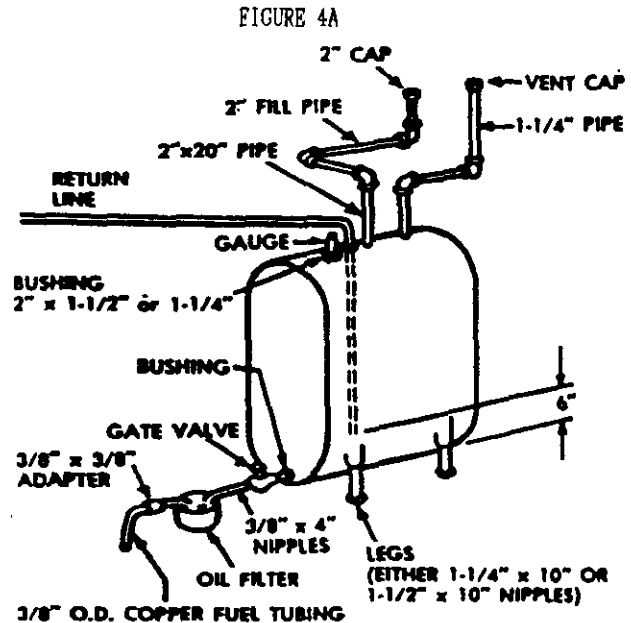

TABLE 6 FURNACE DATA

Model Number	Furnace Installed Standard			Field Installed Option		
	(1) Nozzle Size	Input BTUH	Heating Capacity BTUH (2)	(1) Nozzle Size	Input BTUH	Heating Capacity BTUH (2)
FLR085D36A	.75	105,000	85,000	.65	91,000	75,000
FLR085D36A	.75	105,000	85,000	.65	91,000	75,000
FLR110D48A	1.00	140,000	115,000	.85	119,000	98,000
FLR110D48A	1.00	140,000	115,000	.85	119,000	98,000
FLR140D60A	1.25	175,000	141,000	1.10	154,000	125,000
FCO85D36A	.75	105,000	84,000	.65	91,000	74,000
FBO85D36B	.75	105,000	84,000	.65	91,000	74,000
FH110D48B	1.00	140,000	113,000	.85	119,000	96,000
FH110D60B	1.00	140,000	113,000	.85	119,000	96,000

(1) 80 degree hollow cone spray pattern.

(2) Annual fuel utilization efficiency and heating capacity based upon U.S. Government standard tests using D.O.E. isolated combustion rating procedure.

### CAUTION

Never attempt to use gasoline in your furnace. Gasoline is more combustible than fuel oil and could result in a serious explosion.

## BURNER ADJUSTMENT

All oil burner installations should be performed by a qualified installer in accordance with regulations of the National Fire Protection Standard for Oil-Burning Equipment, NFPA31--latest edition, and in complete compliance with all local codes and authorities having jurisdiction. A qualified installer is an individual or agency who is responsible for the installation and adjustments of the heating equipment and who is properly licensed and experienced to install oil-burning equipment in accordance with all codes and ordinances.

The proper installation and adjustment of any oil-burner requires technical knowledge and the use of combustion test instruments.

## CHECKS AND ADJUSTMENTS

1. Check all oil lines for leaks.
2. Check fuel pump pressure and adjust to 100 psig if necessary.
3. Drill 1/4 inch hole in flue pipe between flue outlet of furnace and barometric damper for draft measurement. Adjust barometric damper to obtain approximately .04 inches water column draft in flue pipe. Check draft overfire. For this measurement the burner observation port may be utilized. Draft overfire should be approximately .02 inches water column. It may be necessary to readjust barometric damper to obtain proper draft. Upon completion of draft readings, plug 1/4" hole in flue pipe with a sheet metal screw after making smoke check and taking stack temperature.
4. Air Adjustments. The air intake is located on the left side of the burner housing. The air shutters are factory set to the recommended start-up settings shown in Table 7. These settings are for initial start only and should be readjusted with the use of combustion analyzing equipment.

Adjust air supply by loosening lock screws and moving air shutter and if necessary the bulk air band. Allow just sufficient air to obtain clean combustion determined by visual inspection. Reduce air supply until flame tips appear slightly smoky, then increase air just enough to make the flame tips appear absolutely clean.

5. Final Adjustments. At this point a final adjustment should be made using suitable instruments for smoke spot and CO<sub>2</sub> (or O<sub>2</sub>) measurements. After allowing 10 to 15 minutes for warm up, air should be set so that the smoke number is zero or a trace; less than No. 1 smoke is highly desirable and should never exceed this limit. (Note: Occasionally a new heating appliance will require longer warm up time in order to burn clean because of the evaporation of oil deposits on the heat exchanger and other surfaces. CO<sub>2</sub> measured in the stack (ahead of the draft control) should be a minimum of 11% and a maximum of 13.0%.

Tighten all locking screws after final adjustments are made.

The unit should be started and stopped several times to make sure there are no significant rumbles or pulsations.

## BURNER NOZZLE AND ELECTRODE ADJUSTMENTS

Check nozzle size as to conformance to installation requirements. Install nozzle by screwing into hexagon adapter. Refer to recommended start-up settings in Table 7.

Spacing of Electrodes. The electrodes should be spaced 5/32" apart. They should extend 1/16" beyond the end and 7/16" above the center of the nozzle tip as shown in the drawing below.

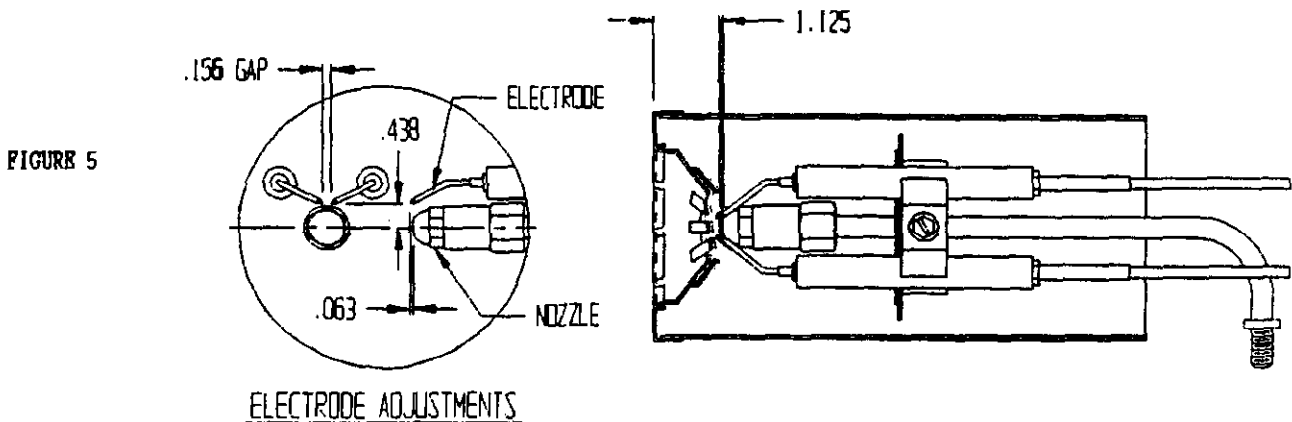

Gun Assembly Adjustment. The gun assembly can be adjusted in the slot inside of fan housing by loosening screw holding slot cover in position. Nozzle tip should ordinarily be located 1-1/8" behind the front face of the cone.

Removing Gun Assembly. Disconnect the oil line at the fan housing and remove lock nuts on copper tube fitting. Remove transformer hold down screw in upper left hand corner and loosen hold down clip in upper right hand corner, then swing transformer up and backward. Gun assembly can now be removed through this opening.

TABLE 7 RECOMMENDED START-UP SETTINGS

Furnace Model No.	Burner Model and Part Number	Factory Installed Nozzle (1)	Field Installed Nozzle (1)	Air Band Setting	Air Shutter Setting
FH085D36B	AF 9020-017	.75		-0-	5
			.65	-0-	3
FH110D48B	AF 9020-017	1.00		-0-	7
			.85	-0-	6
FH110D60B	AF 9020-017	1.00		0	7
			.85	0	6
FLF085D36A	AF 9020-017	.75		-0-	5
			.65	-0-	3
FLF110D48A	AF 9020-017	1.00		-0-	7
			.85	-0-	6
FLR085D36A	AF 9020-018	.75		-0-	5
			.65	-0-	3
FLR110D48A	AF 9020-018	1.00		-0-	8
			.85	-0-	6
FLR140D60A	AF 9020-019	1.25		1	5
			1.10	1	5
FC085D36A	AF 9020-017	.75		0	5
			.65	0	3

(1) 80 degree Hollow cone spray pattern

## VENTILATION AND COMBUSTION AIR

Appliances shall be installed in a location which the facilities for ventilation permit satisfactory combustion of oil, proper venting, and the maintenance of ambient temperature at safe limits under normal conditions of use. Appliances shall be located in such a manner as not to interfere with proper circulation of air within the confined space. When buildings are so tight that normal infiltration does not meet air requirements, outside air shall be introduced. Ducts used to convey air from the outdoors shall be of the same cross-sectional area as the free area of the openings to which they connect. The minimum dimension of rectangular air ducts shall be not less than 3 inches (76 mm). See Table 8 for information on round duct sizing.

For residence-type installations and similar usages, the requirements normally may be obtained by application of one of the methods shown below.

TABLE 8

4,000 BTUH Per Square Inch Round Duct Size	Total BTUH Input
4-3/8	60,000
5-1/8	80,000
5-1/4	85,000
5-7/8	105,000
6-1/8	115,000
6-1/4	120,000
6-3/4	140,000
6-7/8	145,000
7-1/4	160,000
8	200,000

### APPLIANCES LOCATED IN CONFINED SPACES

In unconfined spaces in buildings, infiltration may be adequate to provide air for combustion, ventilation, and dilution of flue gases. However, in buildings of unusually tight constructions, additional air shall be provided using the method described under "All Air From Outdoors" below.

An unconfined space (such as an open basement) must have a minimum volume of 50 cubic feet per 1,000 BTUH of total of all appliances in area. Adjoining rooms may be counted as one area, only if there are no doors between the rooms.

Shown in Table 9 are the required minimum areas in square feet to qualify as an unconfined space for various total BTUH input ratings. The table is based on a room(s) with 8 foot ceiling heights.

TABLE 9

Total BTUH Input	Unconfined Space Minimum Area In Square Feet 8' Ceiling Height
60,000	375
80,000	500
85,000	531
105,000	656
115,000	719
120,000	750
140,000	875
145,000	906
160,000	1000
200,000	1250

FIGURE 6  
APPLIANCES LOCATED IN CONFINED SPACES--  
ALL AIR FROM INSIDE THE BUILDING

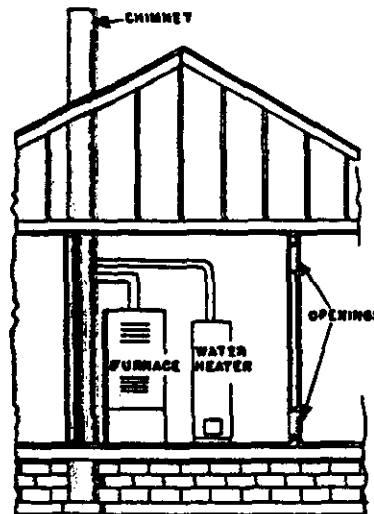

NOTE: Each opening shall have a free area of not less than one square inch per 1,000 BTU per hour (140 square inches per gallon per hour) of the total input rating of all appliances in the enclosure.

If the unconfined space is within a building having insufficient air because of tight construction, the air for combustion and ventilation shall be obtained from outdoors or from spaces freely communicating with the outdoors. Under these conditions a permanent opening or openings have a total free area of not less than one square inch per 5,000 BTU per hour (28 square inches per hour) of total input rating of all appliances shall be provided.

**LOCATED IN CONFINED SPACES**

**ALL AIR FROM INSIDE BUILDING.** The confined space shall be provided with two permanent openings, one near the top of the enclosure and one near the bottom. Each opening shall have a free area of not less than one square inch per 1,000 BTU per hour (140 square inches per gallon per hour) of the total input rating of all appliances in the enclosure freely communicating with interior areas having in turn adequate infiltration from the outside. (See Figure 6) Also see Table 10 for specific ventilation opening requirements for the furnace only.

**TABLE 10**

Model	Minimum Ventilation Opening-Square Inch	Recommended Opening 2 Required	
		Size	Sq. In.
FH085D36B	240	8 x 16	128
FH110D48B	280	9 x 18	162
FH110D60B	280	9 x 18	162
FLF085D36A	290	8 x 19	152
FLR085D36A	290	8 x 19	152
FLF110D48A	340	9 x 19	171
FLR110D48A	340	9 x 19	171
FLR140D60A	360	9.5 x 19	180
FC085D36A	240	8 x 16	128

**THE FLOW OF COMBUSTION AND VENTILATING AIR MUST NOT BE OBSTRUCTED FROM REACHING THE FURNACE.**

**ALL AIR FROM OUTDOORS**

- A. The confined space shall be provided with two permanent openings, one in or near the top of the enclosure and one in or near the bottom. The openings shall communicate directly, or by means of ducts, with outdoors or to such spaces (crawl or attic) that freely communicate with outdoors. (See Figures 7, 8, 9)
- B. When directly communicating with outdoors or by means of vertical ducts, each opening shall have a free area of not less than one square inch per 4,000 BTU per hour (35 square inches per gallon per hour) of total input rating of all appliances in the enclosures. If horizontal ducts are used, each opening shall have a free area of not less than one square inch per 2,000 BTU per hour (70 square inches per gallon per hour) of total input of all appliances in the enclosure.

FIGURE 7  
 APPLIANCES LOCATED IN CONFINED SPACES--  
 ALL AIR FROM OUTDOORS

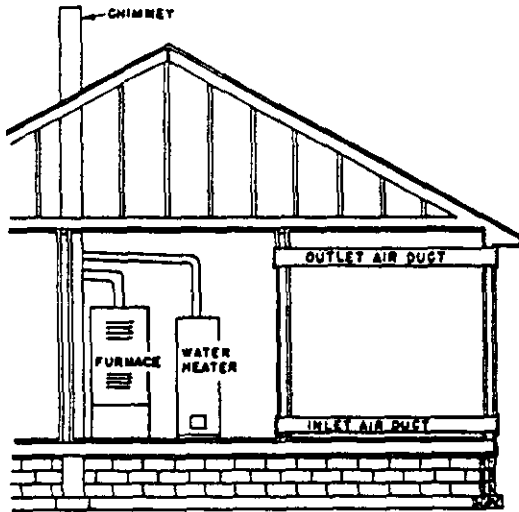

NOTE: Each air duct opening shall have a free area of not less than one square inch per 2,000 BTU per hour (70 square inches per gallon per hour) of the total input rating of all appliances in the enclosure.

FIGURE 8  
 APPLIANCES LOCATED IN CONFINED SPACES--  
 ALL AIR FROM OUTDOORS THROUGH VENTILATED ATTIC

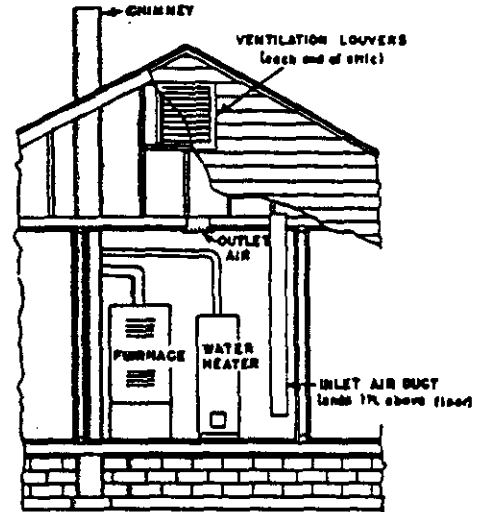

NOTE: The inlet and outlet air openings shall each have a free area of not less than one square inch per 4,000 BTU per hour (35 square inches per gallon per hour) of the total input rating of all appliances in the enclosure.

FIGURE 9  
 APPLIANCES LOCATED IN CONFINED SPACES--  
 ALL AIR FROM OUTDOORS--INLET AIR FROM  
 VENTILATED CRAWL SPACE AND OUTLET AIR TO VENTILATED ATTIC

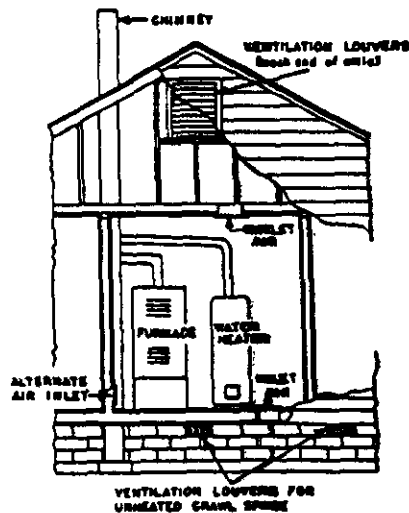

NOTE: The inlet and outlet air openings shall each have a free area of not less than one square inch per 4,000 BTU per hour (35 square inches per gallon per hour) of the total input rating of appliances in the enclosure.

## LOUVERS AND GRILLES

In calculating free area for above ventilation and combustion air requirements, consideration shall be given to the blocking effect of louvers, grilles, or screens protecting openings. Screens used shall not be smaller than 1/4 inch (6.3 mm) mesh and shall be readily accessible for cleaning. If the free area through a design of louver or grille is known, it shall be used in calculating the size opening required to provide the free area specified. If the design and free area is not known, it may be assumed that wood louvers will have 20-25 percent free area and metal louvers and grilles will have 60-75 percent free area.

## VENTING

The flue pipe to the chimney must be the same size as the flue outlet of the furnace, have no reductions, be of a corrosion-resistant material, and have an upward pitch of 1/4" for every foot of horizontal run. A barometric damper of adequate size must be installed in the flue pipe observing the instructions packaged with the damper control. The barometric damper opening must be located in the same atmospheric pressure zone as the combustion air inlet to the furnace. This furnace must not be vented into the same chimney with any solid fuel burning appliance. See Standard for Oil Burning Equipment--NEPA31 for additional information.

## THERMOSTAT

These furnaces are designed to be controlled with any 24V heating or heating/cooling thermostat. The heat/cool thermostats must be designed for independent heat/cool transformer circuits to assure that the 24V transformer built into the oil primary control does not conflict with the main furnace 24V transformer. The heat anticipator should be set at 0.20A. This is a nominal setting. The thermostat circuit should be checked to verify setting. See additional information and wiring details on pages 22 - 24.

## FAN AND LIMIT CONTROL

The fan and limit control is factory installed on all units. See Table 11 for factory settings. The fan on/off settings may have to be varied due to the static pressure imposed upon the system. The limit control is factory set at maximum fixed stop allowable and must not be reset.

When the installation is completed, measure the air temperature in the discharge plenum and return air plenum. The temperature rise across the unit should fall within the "Rise Range" as shown in Table 11. It is normally desirable to operate in the middle of the range unless air conditioning or other installation requirements make that unfeasible. The speed of the blower may have to be either increased or decreased to obtain this temperature. The blower is equipped with a 3 or 4 speed motor to make these adjustments. See wiring details on pages 22 - 24.

The fan and limit control in the burner compartment governs the blower operation, by means of two temperature selections. One lever is set at 140 degrees for example, to start the blower, and the other lever is at a lower temperature, 110 degrees to stop the blower. These settings may be varied to suit the homeowner's comfort. A greater temperature difference between settings may result in less repetition of the blower operation at the end of the heating cycle. A low "off" temperature is recommended for longer blower operation as this keeps the air of the home in more constant circulation.

NOTE: On model FC08SD36A, the blower "on" setting is timed to assure blower operation. This blower "on" setting cannot be adjusted.

### NOTE

Do not set the blower "ON" setpoint lever of the combination fan/limit control above 150.

TABLE 11 TEMPERATURE RISE RANGES, LIMIT CONTROL SETTINGS, AND HEATING BLOWER SPEEDS

MODEL	NOZZLE (1)	RISE RANGES	HEATING BLOWER SPEED	LIMIT SETTING	ON	OFF
FHO85D36B	.65	70 - 100	Low	170	110	90
	.75	60 - 90	Med	170	110	90
FH110D48B	.85	70 - 100	Low	170	110	90
	1.00	60 - 90	Med Low	170	110	90
FH110D60B	.85	60 - 90	Low	170	110	90
	1.00	60 - 90	Med Low	170	110	90
FLFO85D36A	.65	60 - 90	Low	230	140	110
	.75	60 - 90	Med	230	140	110
FLF110D48A	.85	60 - 90	Med Low	230	140	110
	1.00	60 - 90	Med High	230	140	110
FLRO85D36A	.65	60 - 90	Low	250	140	110
	.75	60 - 90	Med	250	140	110
FLR110D48A	.85	60 - 90	Med Low	240	140	110
	1.00	60 - 90	Med High	240	140	110
FLR140D60A	1.10	60 - 90	Med Low2	220	140	110
	1.25	60 - 90	Med High	220	140	110
FCO85D36A	.65	70 - 100	Low	180	125	100
	.75	60 - 90	Med	180	125	100

(1) 80 degree hollow cone spray pattern



## MAINTENANCE

### LUBRICATION

The oil burner motor bearings should be lubricated at least twice each year using a few drops of a good grade of SAE-20 motor oil. Do not over oil, 2 - 4 drops are sufficient. The direct drive comfort air blower motor is considered "Permanently Lubricated" and needs no oiling.

### INSPECT AIR FILTER

Permanent, washable air filters are supplied with each furnace. Permanent filters should not be replaced with disposable type. Clean filters before each heating season begins. It is recommended that filters also be cleaned at least twice during the heating season.

Be sure the new filters are set securely in the filter rack so there can be no leakage around them. (See instructions on inside of blower compartment door).

### FINAL INSPECTION AND TEST

Final inspection and test of an installation shall be made to determine that the work has been done in full accordance with regulations and according to the highest standards for safety, performance and appearance. Such an inspection and test should indicate the following as a minimum:

1. Determine that all parts of the oil storage and circulating system, including tank, piping and burner, are free from oil leaks. Be sure that no oil discharges from the nozzle when burner is not operating.
2. Be sure that the suction line and pump have been entirely vented of air so that the burner has instantaneous oil shutoff at the nozzle and so that the pump operates without an air noise.
3. Check the flame adjustment to determine that the flame is clear, quiet, free of odor and oil nozzle is of proper size for the furnace.
4. Test operation of burner by operating the thermostat. First, set the thermostat above room temperature. Burner should start. Second, set thermostat below room temperature. Burner will stop.
5. Check operation of burner primary control in accordance with manufacturers' instructions included with the control. Following is the method we recommend in checking the safety switch in this primary control.
  - A. Flame Failure--simulate by shutting off oil supply manual valve, while burner is on. After 15 seconds the safety switch locks out, ignition stops, motor stops and the oil valve closes. The safety switch locks out as in flame failure.
  - B. Ignition Failure--test by closing oil supply while burner is off. Run through starting procedure. The safety switch locks out as in flame failure.
  - C. Power Failure--turn off power supply while burner is on. When burner goes out, restore power and burner will restart.
  - D. If operation is not as described, check wiring and installation first. If trouble appears to be in the control circuit, replace the flame detector. If trouble still persists, replace the burner mounted relay.

## SERVICE HINTS

"Preventive maintenance" is the best way to avoid unnecessary expense, inconvenience, and retain operating efficiency of your furnace. It is advisable to have your heating system and burner inspected at periodic intervals by a qualified serviceman. If trouble develops, follow these simple checks before calling the serviceman.

1. Make sure there is oil in tank and valve is open.
2. Make sure thermostat is set above room temperature.
3. Make sure electrical supply to furnace is on and fuses are not blown or circuit breakers tripped.
4. Reset safety switch of burner primary control. CAUTION--RESET ONE (1) TIME ONLY. MORE THAN ONE RESET CAN CAUSE EXCESSIVE OIL TO BE PUMPED INTO COMBUSTION CHAMBER WHICH COULD RESULT IN EXPLOSION UPON IGNITION.
5. Press thermal protector button of burner motor.
6. Make sure air filters are in place and are clean.
7. Make sure all air openings in furnace, all ventilation and combustion air openings, all return air grilles, and all warm air registers are unobstructed and open.

## COMMON CAUSES OF TROUBLE

### CAUTION

To avoid accidents, always  
turn off main power switch  
before servicing burner.

**BURNER WILL NOT PRODUCE FLAME.** Check oil level gauge to see that there is sufficient oil in tank or tanks. Check the burner mounted relay control. DO NOT ADJUST THIS CONTROL.

Check position of electrodes; incorrect position will cause slow or delayed ignition. Clean electrodes and nozzle. Check and clean strainer in pump. If oil line filter is used, check filter condition.

If burner runs but there is no flame, the fuel pump may be airbound. Follow instructions for bleeding fuel pump.

**BURNER STARTS OR STOPS TOO OFTEN.** Limit control may be set too low. Check heat anticipator setting on thermostat.

**NOZZLE PRODUCES A STRINGY FLAME.** Worn tangential grooves in nozzle. Replace nozzle.

**BASEMENT TANK HUM.** Occasionally with a two-pipe installation there may be a low return line hum. Eliminate hum by installing a special anti-hum valve in the return line near pump.

**HEAVY FIRE OR PULSATING FLAME** may occur after burner starts. It may be caused by a slight oil leak in the fuel pump and cannot be corrected except by replacing the pump. This happens only when the burner is started.

**CHATTERING SOUND OR HIGH PITCH NOISE** from motor can usually be traced to where a conduit or BX cable is fixed rigidly or attached to some part of the building. Relieving this strain may eliminate noise.

**PUMP SQUEALS OR CHATTERS.** This may be caused by air in pipes. Check all joints in the oil supply pipe for leaks. Check strainer in pump; if dirty, clean.

**INSUFFICIENT HEAT.** Check limit control setting. It may be that flame is not allowed to stay on long enough to generate sufficient heat in furnace to heat the house properly. If the proper size furnace has been selected according to house requirements and satisfactory heat is not obtained, recheck the heating plant for size and capacity in relation to house. Check for clogged filters.

## **CARE OF FINISH**

Your unit is painted with baked enamel. Like a good piece of furniture, it has an excellent appearance and an occasional waxing and dusting will keep it attractive for years.

## **CLEANING OF FURNACE**

All of these units have two clean out plugs for easy cleaning of the heat exchanger. They are accessible from the front of these units by removing the two cover plates in the burner compartment. The furnace should be checked annually by a qualified service technician.

MODEL FH085036A HI-BOY FURNACE

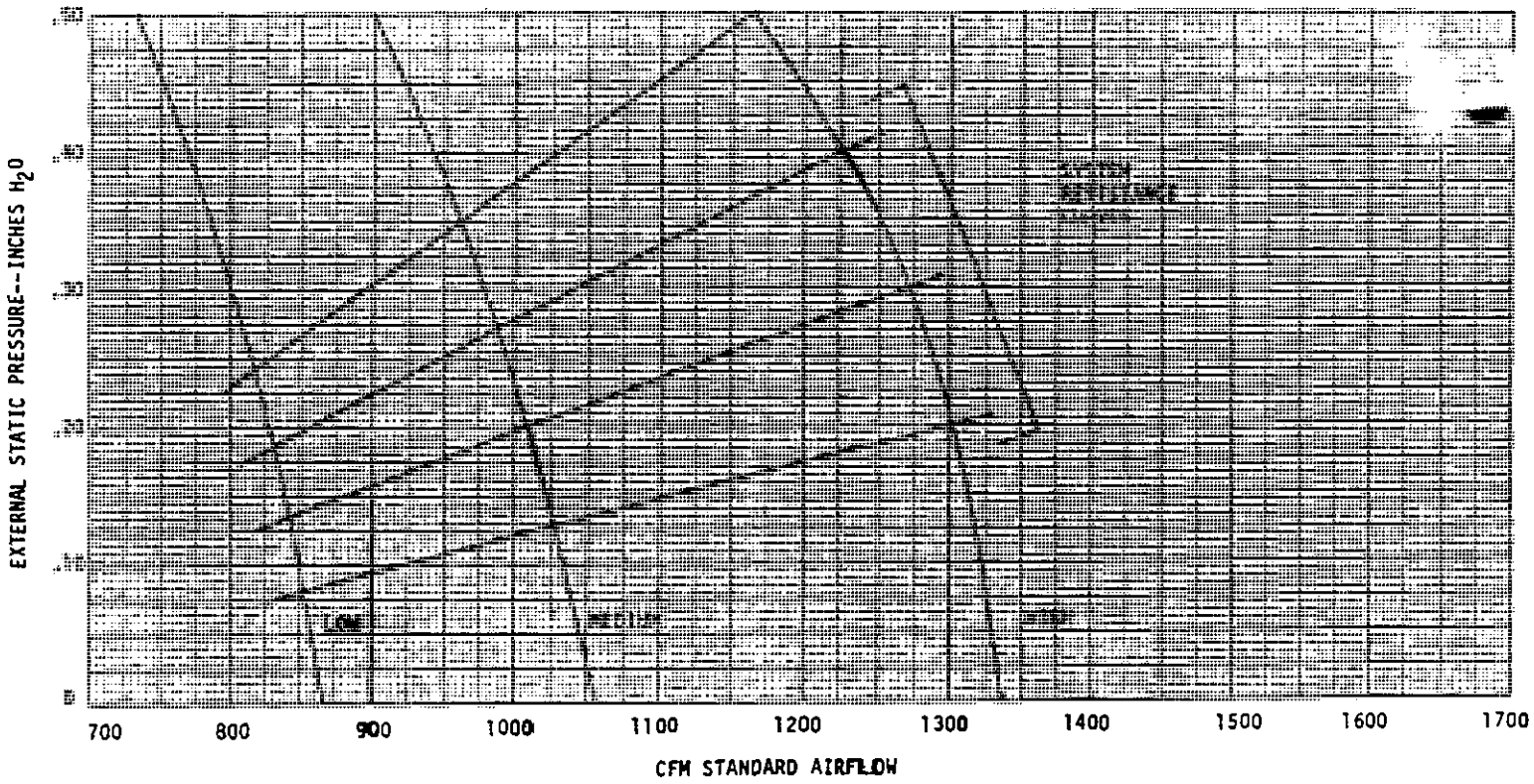

MODEL FH110D48A HI-BOY FURNACE

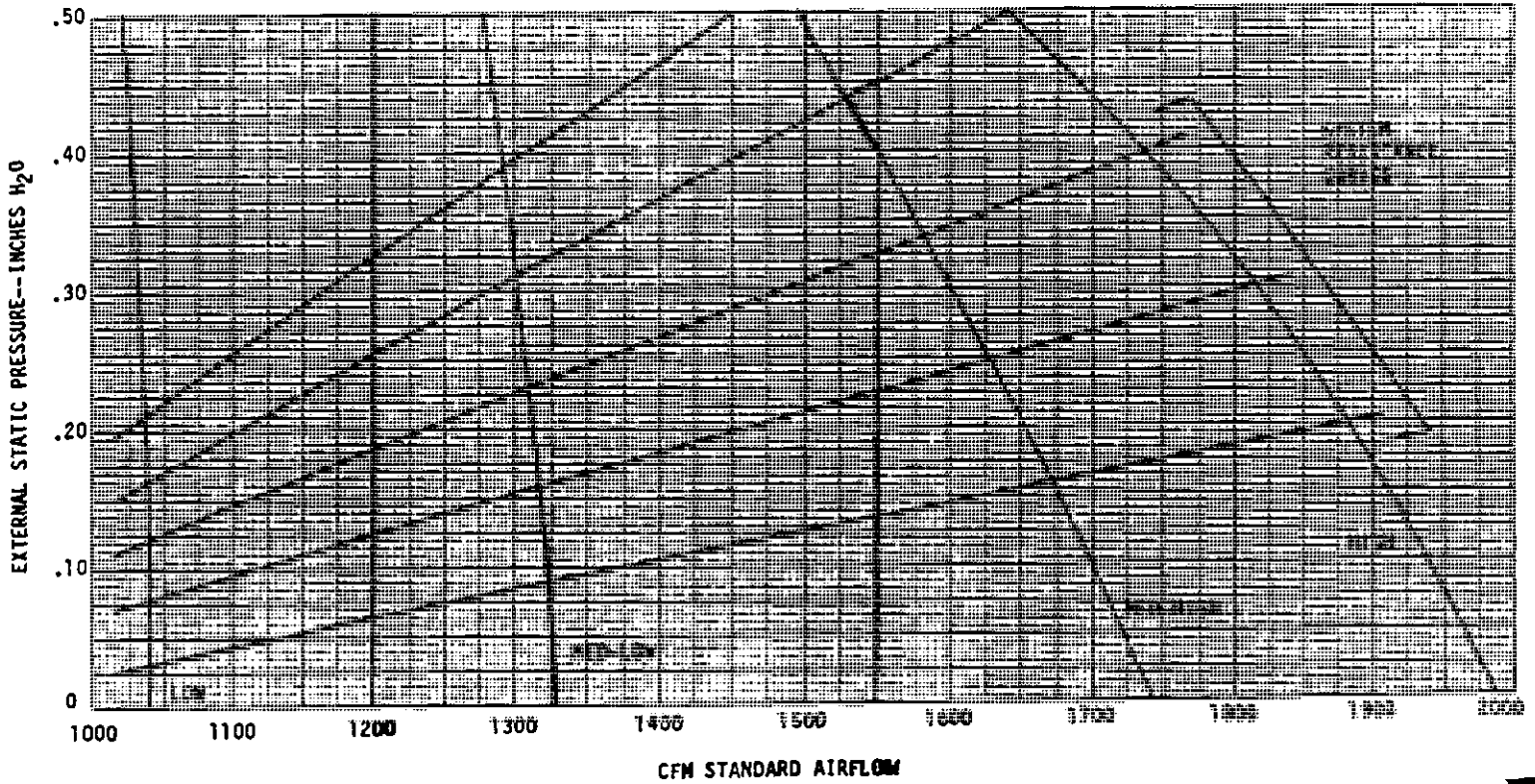

MODEL FH110D60B HI-BOY FURNACE

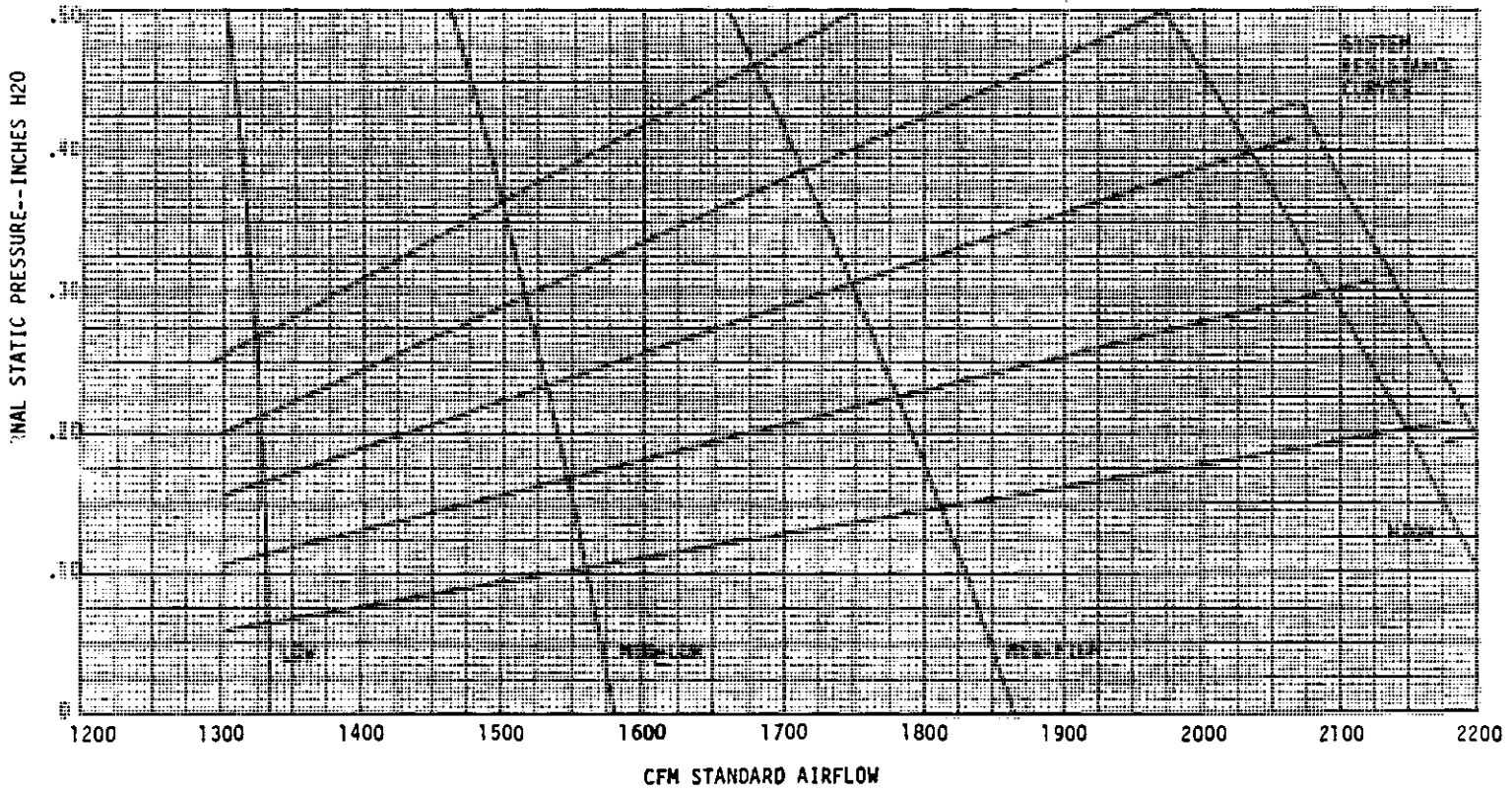

MODEL FLF085036A LO-BOY FURNACE

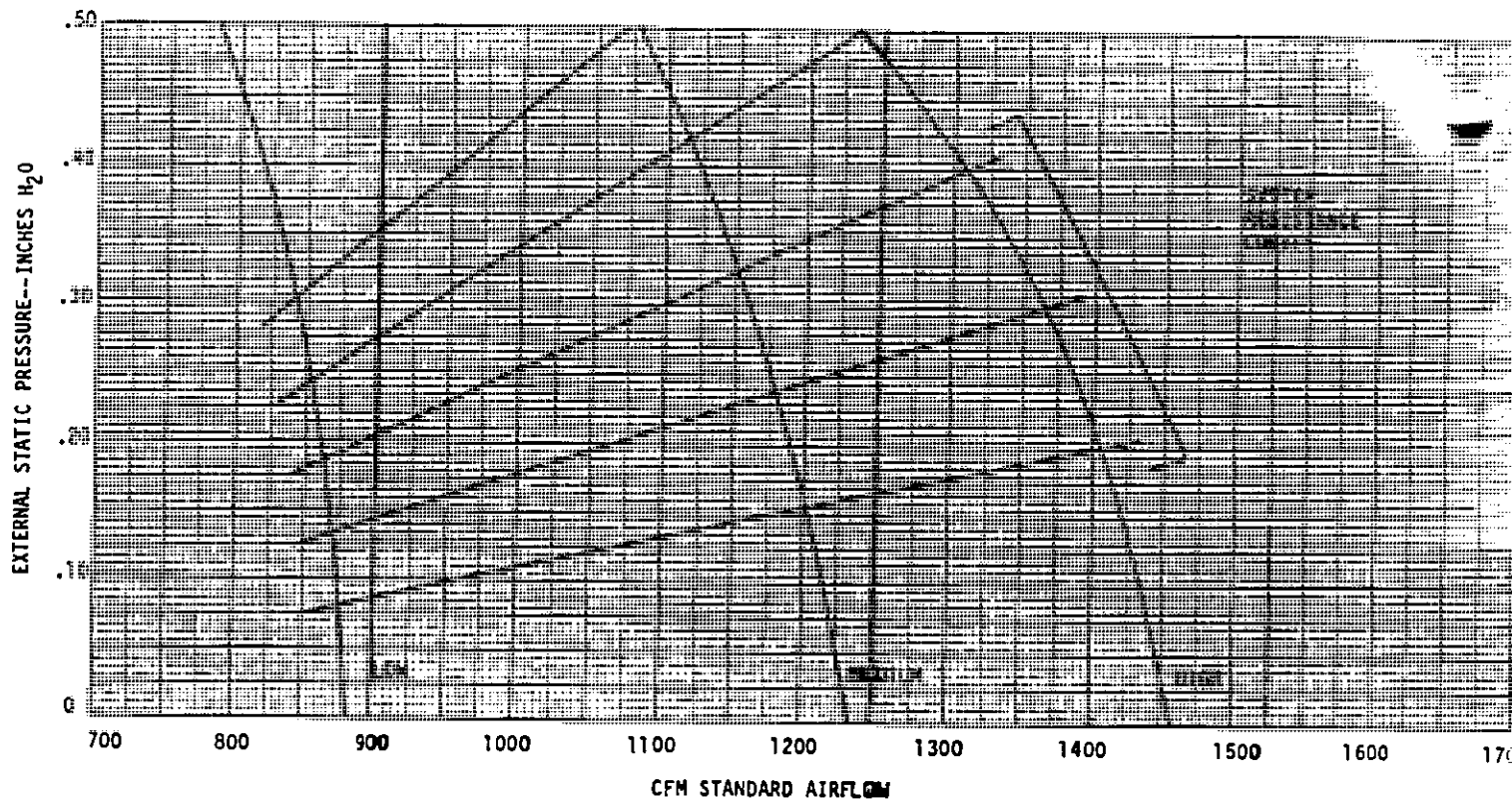

MODEL FLF110048A LO-BOY FURNACE

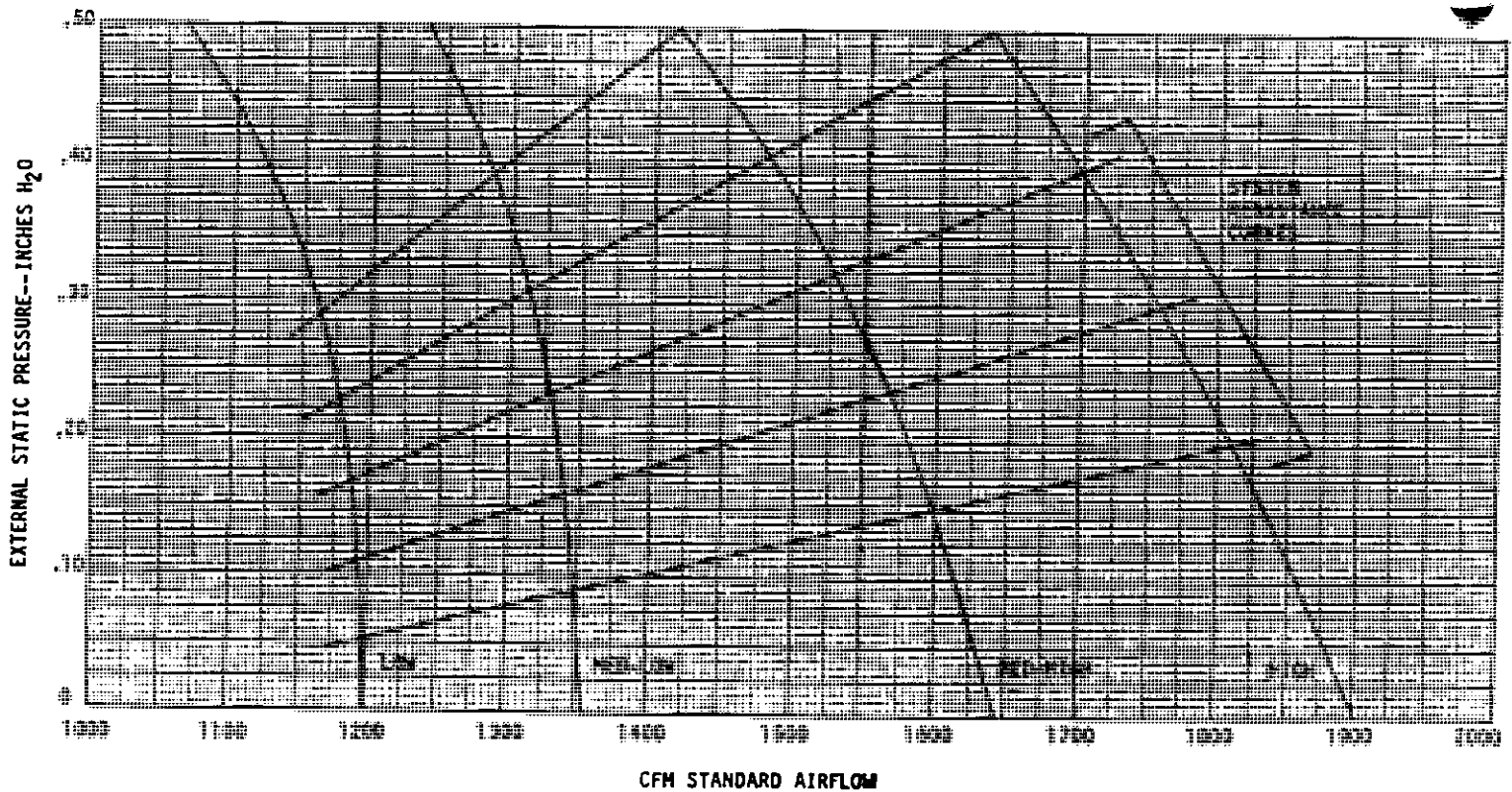

MODEL FLR085D36A LO-BOY FURNACE

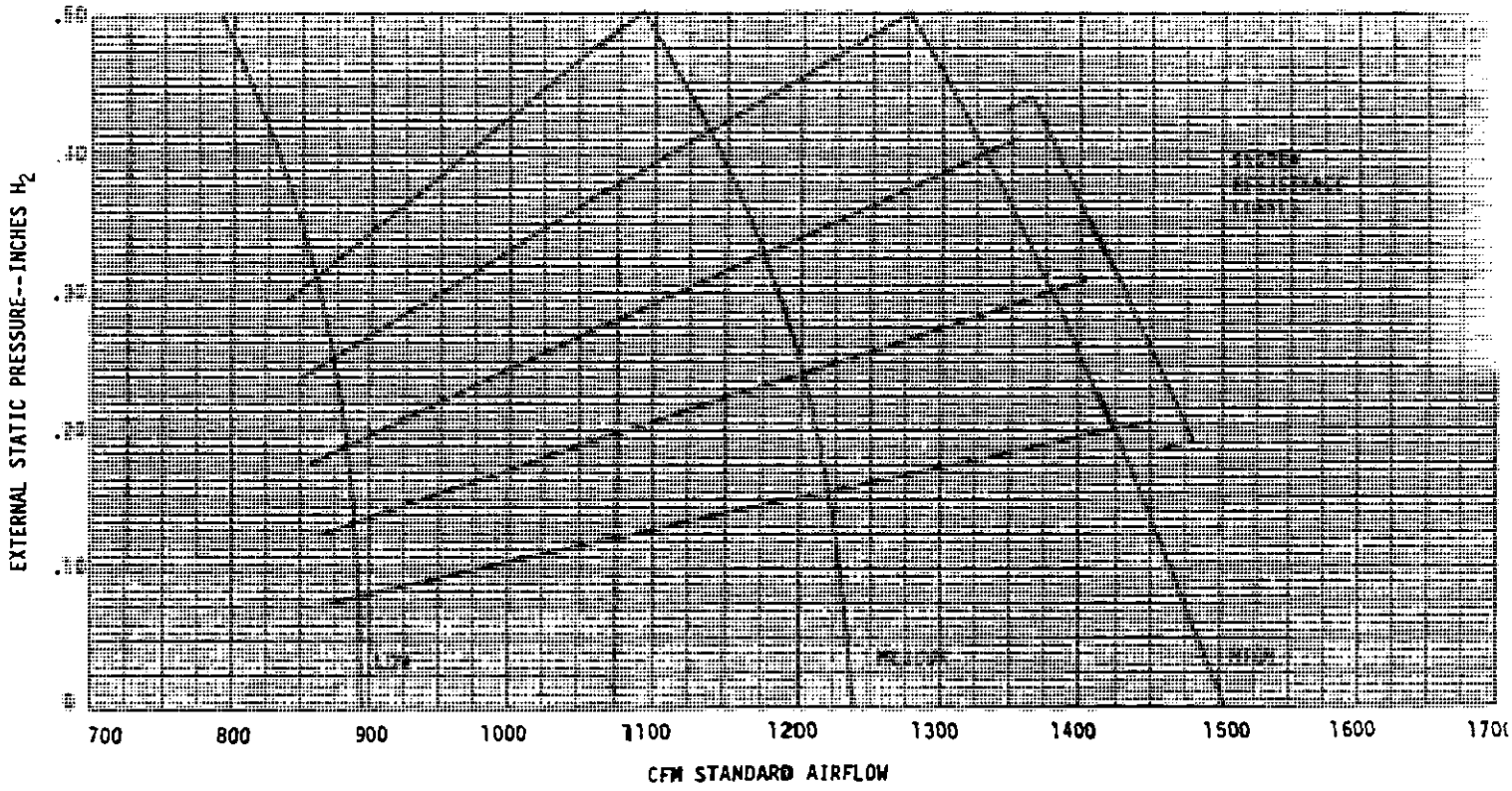

MODEL FLR110D48A LO-BOY FURNACE

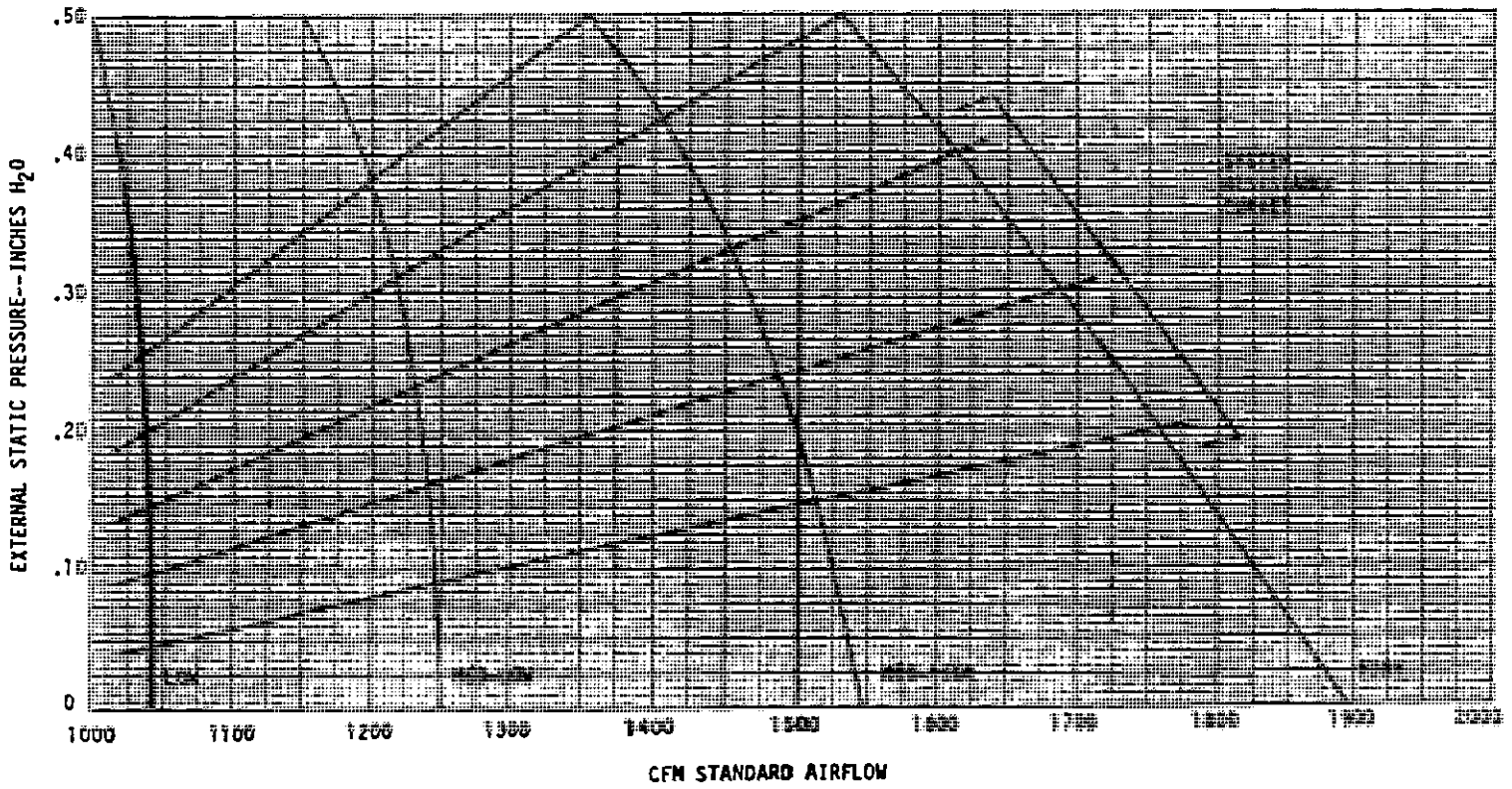

MODEL FLR140D60A LO-BOY FURNACE

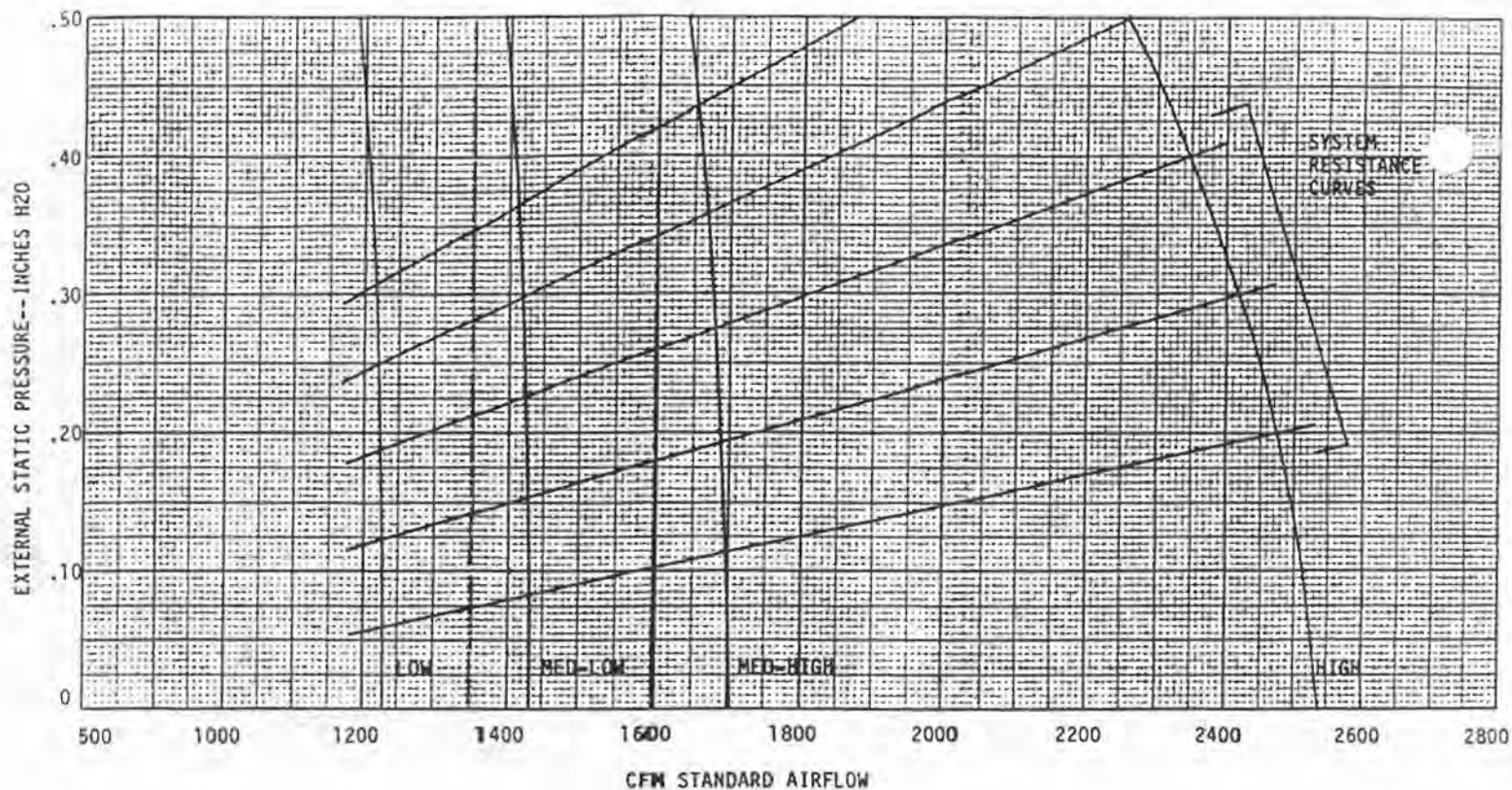

MODEL FC085D36A COUNTERFLOW FURNACE

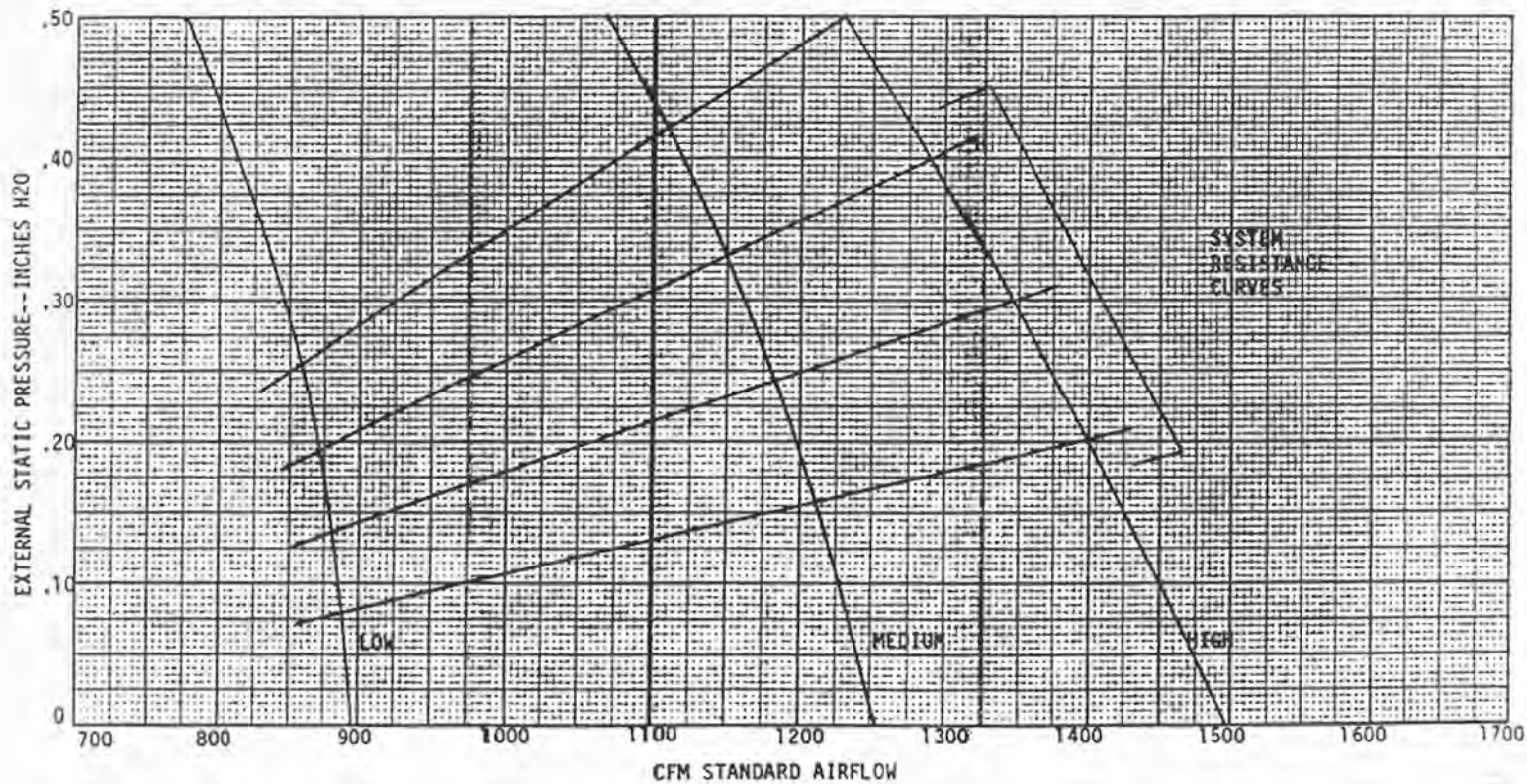



**CONNECTION DIAGRAM DANGER: ELECTRICAL SHOCK HAZARD DISCONNECT POWER BEFORE SERVICING.**

TECHNICAL INFORMATION			
MODEL	INPUT VOLTAGE	HEATING BLOWER SPEED (COLOR)	TEMPERATURE RISE RANGE
FRIGIDAIRE	65	LOW (RED)	70° - 100°
	75	MED (BLUE)	60° - 90°
PHILCO	65	LOW (ORANGE)	70° - 100°
	75	MED-HI (RED)	60° - 90°
PHILCO	65	LOW (ORANGE)	70° - 100°
	75	MED-HI (RED)	60° - 90°

MOTOR COLOR CODE		
COLOR & SPEED	3 SPEED	
WHITE	COMMON	COMMON
BROWN	CAP	MOTOR
BLACK	HIGH	MED
BLUE	MED HI	LOW
RED	MED LOW	LOW
ORANGE	LOW	

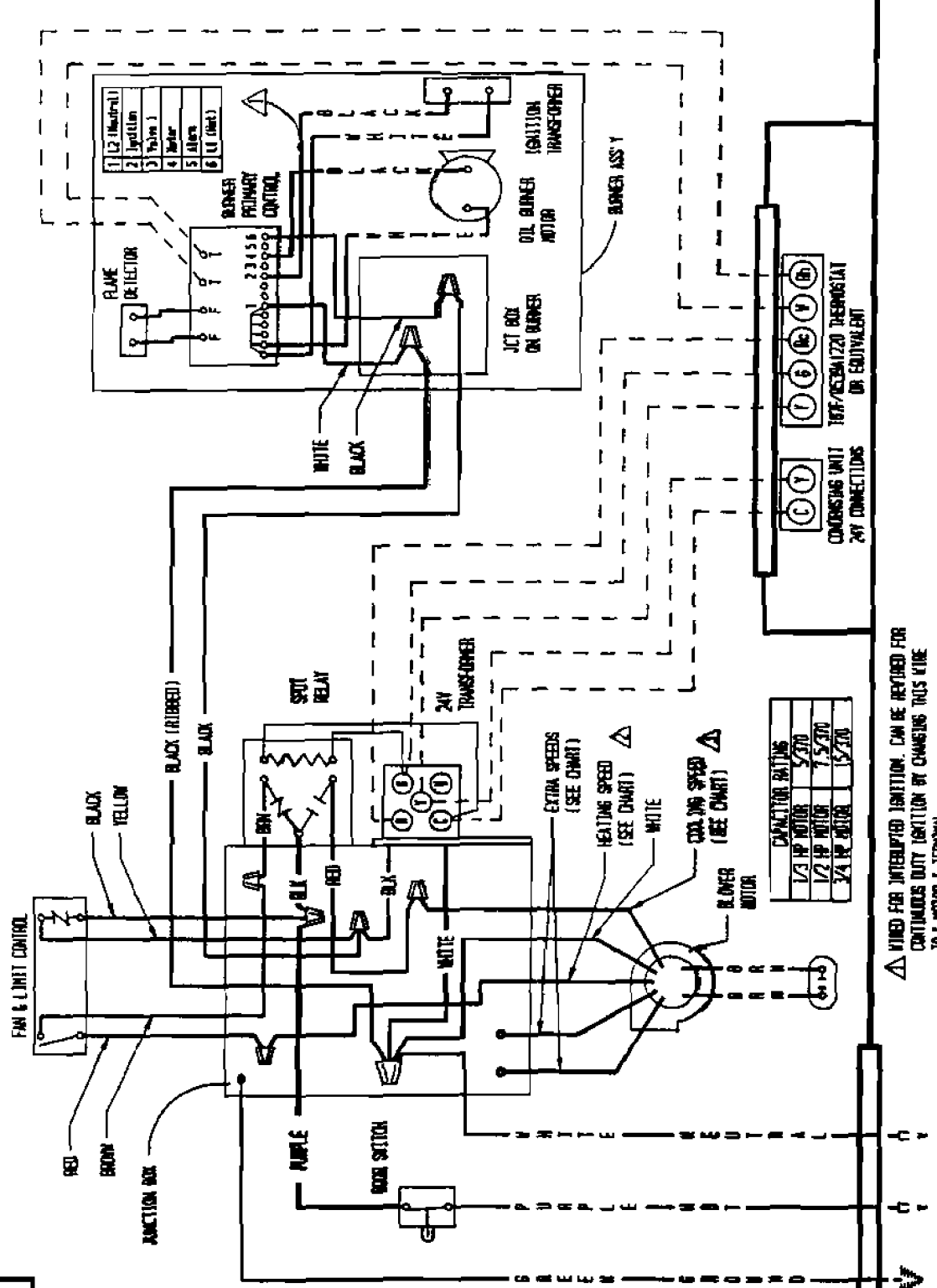

CAPACITOR RATINGS	
1/3 HP MOTOR	5.0/70
1/2 HP MOTOR	7.5/70
3/4 HP MOTOR	15.0/70

- ▲ WIRED FOR INTERRUPTED IGNITION. CAN BE REWIRED FOR CONTINUOUS DUTY IGNITION BY CHANGING THIS WIRE TO " MOTOR " TERMINAL.
- ▲ FACTORY WIRED USING RED WIRE FOR PH10, AND BLUE WIRE FOR PH05.
- ▲ FACTORY WIRED USING BLACK WIRE.

CONDENSING UNIT 24V CONNECTIONS OR EQUIVALENT	
(C) (Y)	(1) (6) (5) (4) (3) (2) (1)
FACTORY WIRING	FIELD WIRING

IF ANY OF THE ORIGINAL WIRE AS SUPPLIED WITH THE APPLIANCE MUST BE REPLACED, IT MUST BE REPLACED WITH WIRING MATERIAL HAVING A TEMPERATURE RATING OF AT LEAST 105 DEG C.

CONNECTION DIAGRAM JUMPER: ELECTRICAL SHOCK HAZARD DISCONNECT POWER BEFORE SERVICING.

TECHNICAL INFORMATION			
MODEL	INPUT RATE	HEATING BLOWER SPEED (COLOR)	TEMPERATURE RISE RANGE
FD0530A	.65	LOW (RED)	50° - 80°
FD0530B	.75	HIGH (BLUE)	60° - 90°

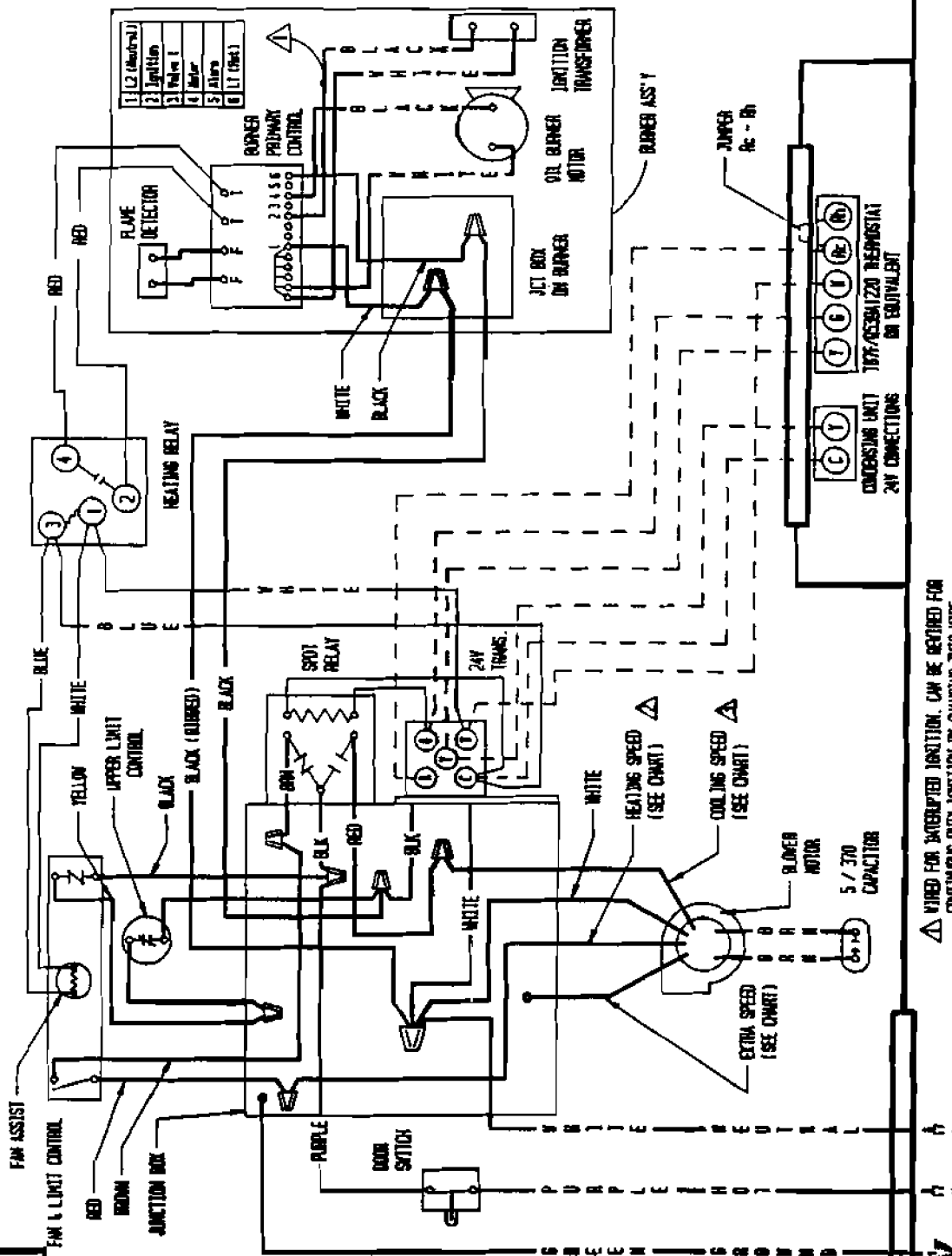

FACTORY WIRING	FIELD WIRING
Low Voltage	High Voltage

△ WIRED FOR WATER-IGNITED IGNITION. CAN BE RETIRED FOR CONTINUOUS DUTY IGNITION BY CHANGING THIS WIRE TO " MOTOR " TERMINAL.

△ FACTORY WIRED USING BLUE WIRE

△ FACTORY WIRED USING BLACK WIRE

115-60-1

IF ANY OF THE ORIGINAL WIRE AS SUPPLIED WITH THE APPLIANCE MUST BE REPLACED, IT MUST BE REPLACED WITH WIRING MATERIAL HAVING A TEMPERATURE RATING OF AT LEAST 105 DEGS C.

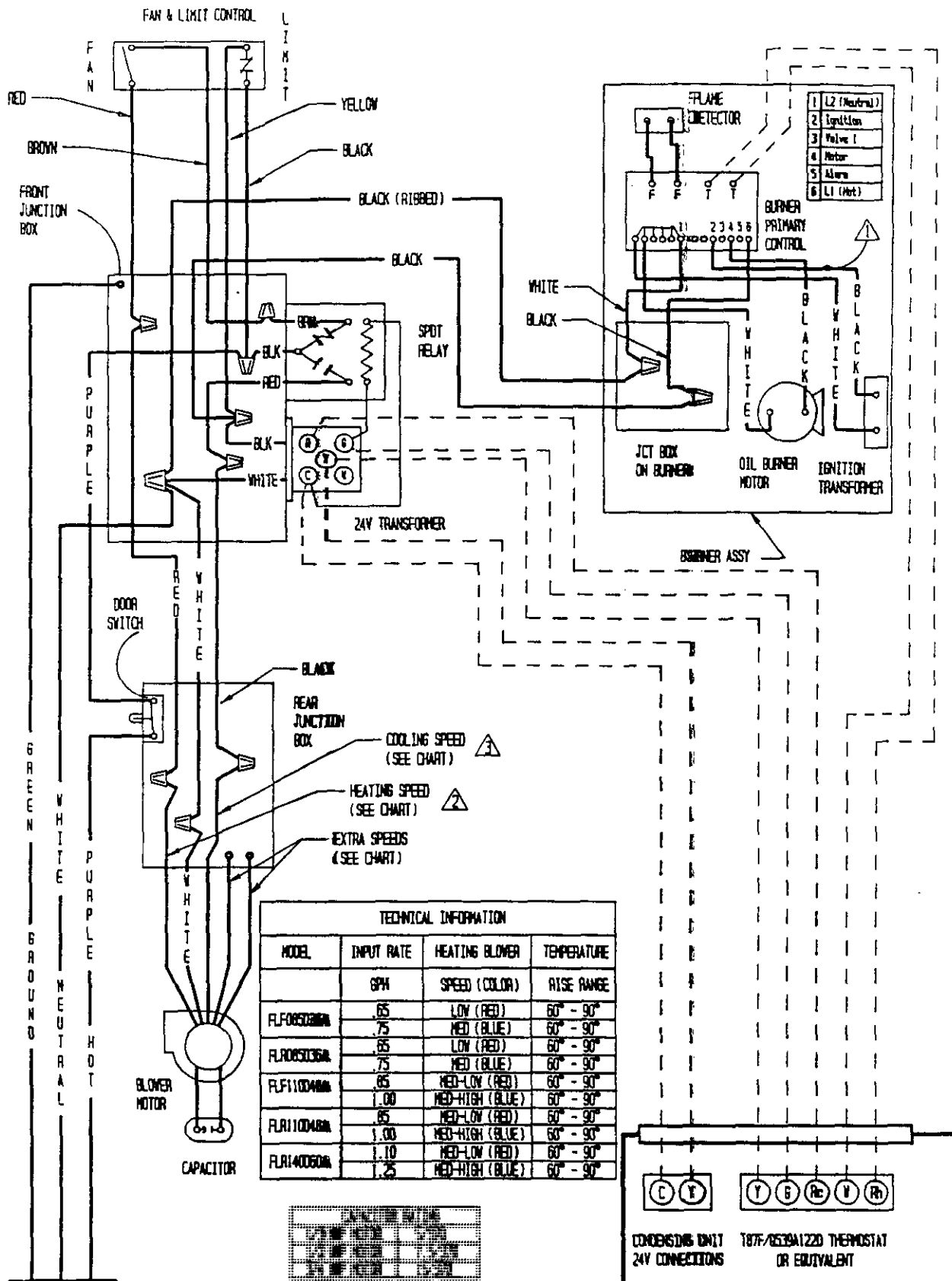

TECHNICAL INFORMATION			
MODEL	INPUT RATE	HEATING BLOWER	TEMPERATURE
	GPH	SPEED (COLOR)	RISE RANGE
FLF050200A	.65	LOW (RED)	60° - 90°
FLF050200A	.75	MED (BLUE)	60° - 90°
FLR050200A	.65	LOW (RED)	60° - 90°
FLR050200A	.75	MED (BLUE)	60° - 90°
FLF1100400A	.85	MED-LOW (RED)	60° - 90°
FLR1100400A	1.00	MED-HIGH (BLUE)	60° - 90°
FLR1100400A	.85	MED-LOW (RED)	60° - 90°
FLR1100400A	1.00	MED-HIGH (BLUE)	60° - 90°
FLR1400600A	1.10	MED-LOW (RED)	60° - 90°
FLR1400600A	1.25	MED-HIGH (BLUE)	60° - 90°

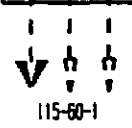
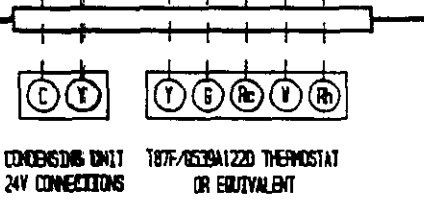

- ▲ WIRED FOR INTERRUPTED IGNITION. CAN BE REVISED FOR CONTINUOUS DUTY IGNITION BY CHANGING WIRE TO "MOTOR" TERMINAL
- ▲ FACTORY WIRED USING BLUE WIRE
- ▲ FACTORY WIRED USING BLACK WIRE

**CONNECTION DIAGRAM** DANGER: ELECTRICAL SHOCK HAZARD  
DISCONNECT POWER BEFORE SERVICING

IF ANY OF THE ORIGINAL WIRE AS SUPPLIED WITH THE APPLIANCE MUST BE REPLACED, IT MUST BE REPLACED WITH WIRING MATERIAL HAVING A TEMPERATURE RATING OF AT LEAST 105 DEG C.

	FACTORY WIRING	FIELD WIRING
Low Voltage	—	---
High Voltage	---	---

MOTOR COLOR CODE		
COLOR	4 SPEED	3 SPEED
WHITE	COMMON	COMMON
BROWN	CAP	CAP
BLACK	HIGH	HIGH
BLUE	MED HI	MED LOW
RED	MED LOW	LOW
ORANGE	LOW	---

# A-7000 SINGLE STAGE AND B-8000 TWO STAGE FUEL UNITS

MODELS A2 & B2 FOR 3450 RPM, WHITE LABEL

MODEL B TWO STAGE FUEL UNIT HAS SAME PORTING ARRANGEMENT AS MODEL A

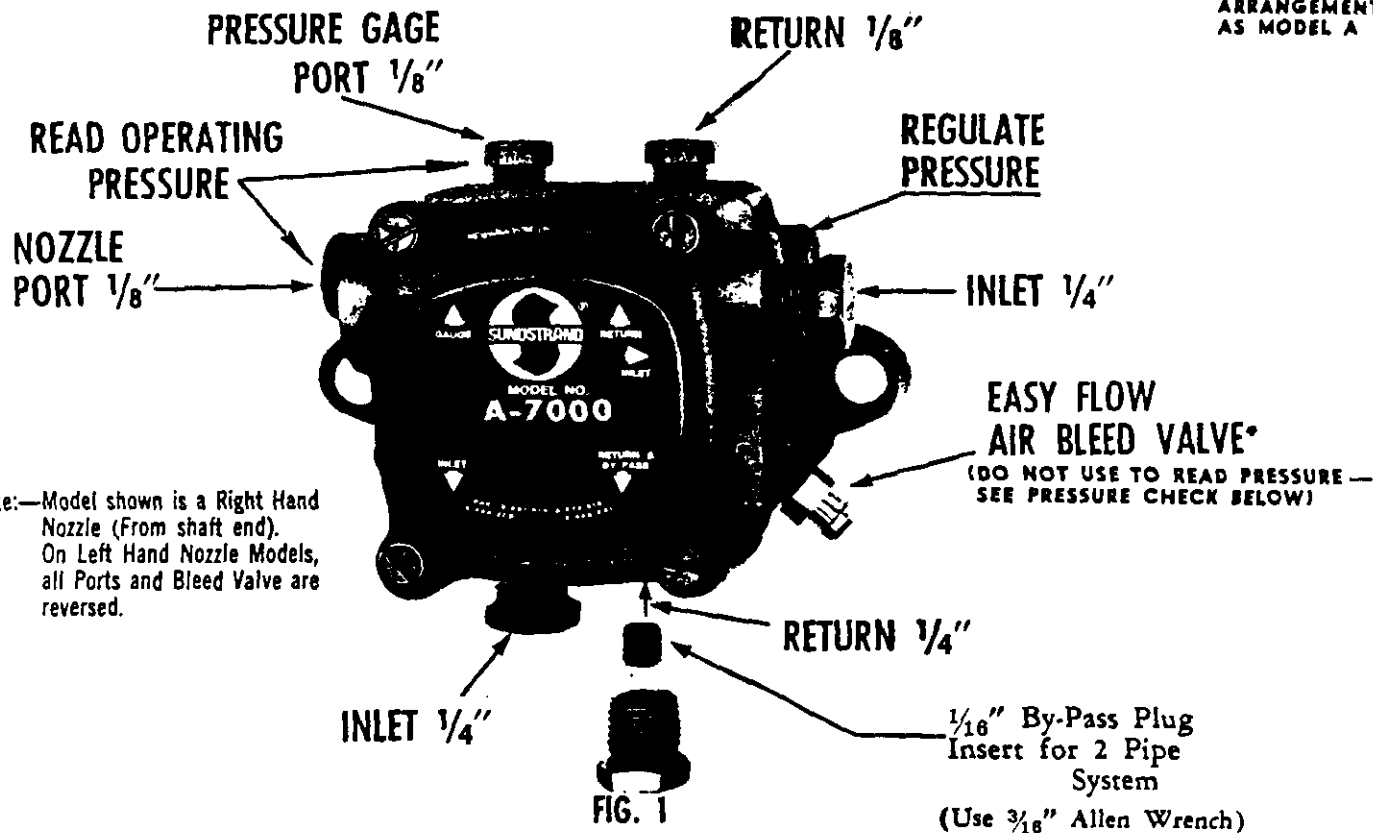

Note:—Model shown is a Right Hand Nozzle (From shaft end). On Left Hand Nozzle Models, all Ports and Bleed Valve are reversed.

FIG. 1

## ONE-PIPE SYSTEM

Connect inlet line to pump inlet. Start burner. Arrange primary burner control for continuous operation during purging. Open easy flow bleed valve 1/2 turn CCW and start burner. Bleed unit until all air bubbles disappear—HURRIED BLEEDING WILL IMPAIR EFFICIENT OPERATION OF UNIT. Tighten easy flow bleed valve securely.

## TWO-PIPE SYSTEM

Remove 1/16" plug from plastic bag attached to unit. Remove 1/4" plug from return port. Insert by pass plug (See Figure 1). Attach return and inlet lines.

Start burner—Air bleeding is automatic. Opening Easy Flow Air Bleed Valve will allow a faster bleed if desired.

Return line must run to within 3" of the bottom of the tank (See Figure 3). Failure to do this may introduce air into the system and could result in loss of prime.

## CAUTION

Pressurized or gravity feed installations must not exceed 10 P.S.I. on inlet line or return line at the pump. A pressure greater than 10 P.S.I. may cause damage to the shaft seal.

## PRESSURE CHECK

If a pressure check is made, use GAGE PORT OR NOZZLE PORT. DO NOT USE EASY FLOW BLEED VALVE PORT. The Easy Flow Bleed Valve Port contains pressure higher than operating pressure. Setting pump pressure with gage in the Easy Flow Bleed Valve Port results in WRONG operating pressure.

## ALL SYSTEMS

### IMPORTANT INFORMATION

Long or oversized inlet lines may require the pump to operate dry during initial bleeding period. In such cases, the priming may be assisted by injecting fuel oil into the pump gearset.

Under lift conditions, oil lines and fittings must be air tight. To assure this, "Pipe Dope" may be applied to both the used and unused inlet and both return fittings.

### MOUNTING POSITION

Model "A" Single Stage Fuel Unit may be mounted in any position.

Model "B" Two Stage Fuel Unit may be mounted in any position except upside down (1/8" ports pointed down).

## VACUUM CHECK

A Vacuum Gage may be installed in either of the 1/4" let ports or in the 1/8" return port (on single pipe installations), whichever is most convenient. The Model "A" pump should be used where the vacuum does not exceed 10" hg, vacuum and the Model "B" pump used where vacuum does not exceed 20" hg, vacuum.

# ONE-PIPE SYSTEM (Model A)

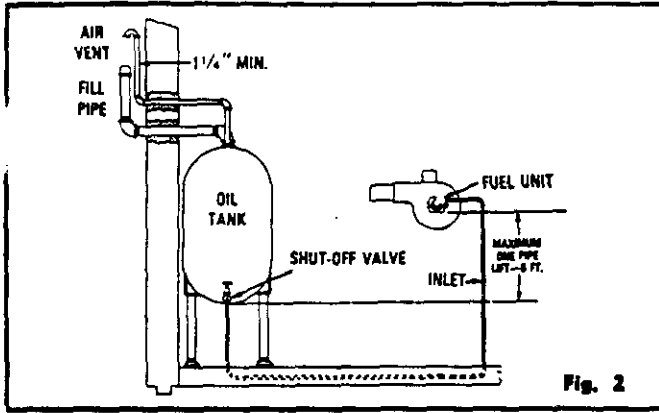

The SUNDSTRAND MODEL "A"-70 FUEL UNIT may be installed ONE-PIPE with Gravity Feed or Lift.

The maximum allowable lift is 8 ft.—See Figure 2.

**IMPORTANT:** One-pipe installations must be absolutely air tight or leaks or loss of prime may result. Bleed line and fuel unit completely. Bleed for 15 seconds after last air is seen from easy flow to be certain lines are air free.

# TWO-PIPE SYSTEM (Model A and B)

## A SINGLE STAGE

Lift "L" Fig 3	1725 RPM		3450 RPM	
	3/8" OD Tubing	1/2" OD Tubing	3/8" OD Tubing	1/2" OD Tubing
0'	65'	100'	53'	100'
1'	60'	100'	49'	100'
2'	54'	100'	45'	100'
3'	50'	100'	41'	100'
4'	45'	100'	37'	100'
5'	40'	100'	33'	100'
6'	35'	100'	29'	100'
7'	30'	100'	25'	99'
8'	25'	100'	21'	83'
9'	20'	83'	17'	68'
10'	16'	64'	13'	52'

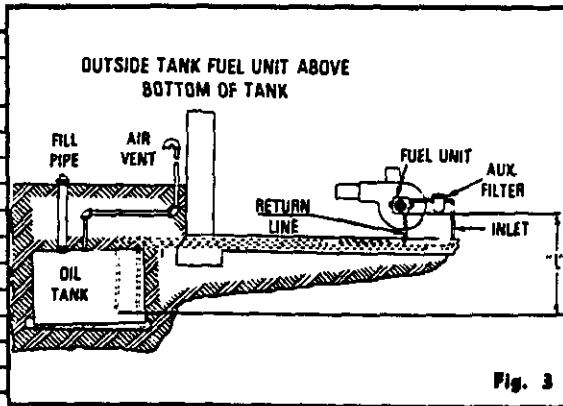

## B TWO STAGE

Lift "L" Fig 3	1725 RPM		3450 RPM	
	3/8" OD Tubing	1/2" OD Tubing	3/8" OD Tubing	1/2" OD Tubing
0'	100'	100'	68'	100'
2'	92'	100'	63'	100'
4'	85'	100'	58'	100'
6'	78'	100'	53'	100'
8'	70'	100'	48'	100'
10'	63'	100'	42'	100'
12'	56'	100'	37'	100'
14'	48'	100'	32'	100'
16'	40'	100'	27'	100'
18'	33'	100'	22'	88'

ALWAYS TERMINATE RETURN LINE AS SHOWN IN FIG. 3  
LINE LENGTHS INCLUDE BOTH VERTICAL & HORIZONTAL LENGTHS

# Beckett

## MICROPROCESSOR RECYCLE PRIMARY CONTROL MODEL TFA 850.2

The TFA 850.2 Control Provides Automatic, Recycling Control of an Interrupted Ignition Oil Burner.

- Self-check circuitry before start up.
- Integral transformer provides low voltage power for control circuit.
- Used with CD8 Cadmium Sulfide Cell.
- Microprocessor timer cuts off ignition after trial for ignition.
- 60 second nominal recycle timing.
- Available with 15 or 45 second safety timing.
- Enclosed safety switch is reset manually by the reset button.
- Mounts on standard 4 X 4 inch junction box!
- Exposed terminal strip with screw terminals for low voltage connection.
- Terminal strip for line voltage connections.

### TFA 850.2 TECHNICAL SPECIFICATIONS

<b>Supply Voltage:</b>	120 volts 60 Hz
<b>Power consumption:</b>	max. 10 VA
<b>Low-voltage protection at start:</b>	No start below 86 volts
<b>Max. current rating:</b>	— MOTOR 10 amp. (locked rotor 60 amp.) — IGNITION 500 VA
<b>Temperature range:</b>	operation: 20° ... +125° FAHRENHEIT -5° ... +50° CELSIUS storage: -5° ... +140° FAHRENHEIT -20° ... +60° CELSIUS
<b>Thermostat open voltage:</b>	approx. 24 volt ac
<b>Thermostat anticipator setting:</b>	0.2 amp
<b>Display:</b>	6 functions: — red: safety lockout — red flashing: self-check failure — green: power on, normal function — green flashing: low supply voltage — amber: stray light or shorted cad cell — amber flashing: recycle mode
<b>Flame amplifier sensitivity:</b>	— Start-up: approx. 20k OHMS — Run mode: approx. 4k OHMS
<b>Weight—</b>	
<b>control:</b>	.87 LBS
<b>base:</b>	.28 LBS
<b>Mounting attitude:</b>	any

### INSTALLATION

#### CAUTION:

1. Installer must be a trained, experienced service technician.
2. Disconnect power supply before beginning installation.
3. Be sure combustion chamber is free of liquid or vaporized oil before attempting to start burner.
4. Perform a thorough checkout before leaving.

The TFA850.2 mounts on a standard 4 X 4 inch junction box. Locate the junction box in any convenient position on the burner, furnace, or nearby wall. Select a location where the ambient temperature will not exceed 125°F. When wiring is complete, secure the TFA850.2 to the junction box with 2 mounting screws.

### Wiring

#### CAUTION

Disconnect power supply before making wiring connections to prevent electrical shock and equipment damage.

All wiring must comply with applicable codes and ordinances. Refer to information furnished by the system equipment manufacturer when wiring.

**SYSTEM** — Connect the TFA850.2 to the system wiring at the terminals on base.

**THERMOSTAT** — Run wires from the low voltage thermostat directly to the low voltage terminal strip and connect to T-T terminals.

**CADMIUM SULFIDE CELL** — Run the No. 18 leads from the cad cell (usually installed by the burner manufacturer) to the low voltage terminal strip, connect to the F-F terminals.

### OPERATION

#### Summary

On 24 volt thermostat call for heat, the TFA850.2 microprocessor goes through a self-check (approx. 1-4 seconds); the burner motor, oil valve, and ignition transformer are then energized. On line voltage call for heat, the TFA850.2 microprocessor goes through a self-check (approx. 10-15 seconds); the burner motor, oil valve, and ignition transformer are then energized. The TFA850.2 provides interrupted ignition by using a microprocessor to provide ignition during safety lockout timing period. If the cad cell fails to detect a flame within the specified period of time (15 or 45 seconds), the microprocessor locks out and must be reset for renewed burner operation.

If the flame should fail during normal operation, the burner immediately shuts down. After the control timer recycles (approximately 60 seconds), the burner will attempt to restart. If the cad cell then does not detect a flame within the specified period, the safety switch locks out and must be manually reset. The homeowner should not reset the control more than three (3) times.

#### Sequence of Operation

##### NORMAL OPERATION

EXTERNAL ACTION	PROTECTOR RELAY ACTION
Close line switch.	Transformer primary is energized when line voltage is supplied to the control.
Thermostat calls for heat (move thermostat setting to top of scale, contacts close).	The microprocessor goes through a self check of its circuitry (1-4 sec.), then energizes the burner motor, oil valve, and ignition relay contacts and starts safety time.
Cad cell senses flame.	At end of safety time, ignition is cut-off. The burner continues to operate as long as heat is called for.
Heat demand is satisfied. (Move thermostat setting to bottom of scale, contacts open).	Microprocessor turns off the burner motor and oil valve.

##### SAFETY OPERATION

Burner fails to ignite on call for heat.	Microprocessor goes through self check then starts burner motor, oil valve, and ignition. Also, initiates safety timing and locks out. Reset by pressing reset button.
Flame fails during on-cycle.	When the cad cell no longer senses flame, microprocessor is de-energized. After the microprocessor recycles (approximately 60 seconds), microprocessor goes through self check, then starts burner motor, oil valve and ignition. If flame is not established, goes to safety lock out. The safety switch must be manually reset. (If flame is re-established within the safety switch timing period, operation returns to normal.)
Power failure during call for heat.	System shuts down safely — all relays drop out; no power to the transformer or system (burner motor, oil valve, and ignition). System returns to normal operation when power is restored. Microprocessor requires 15 seconds to self-check before system can restart.)

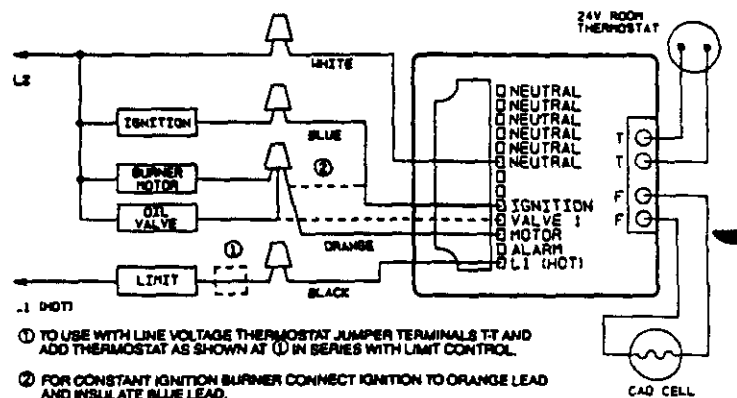

## SERVICE AND CHECKOUT

### Service

The TFA850.2 microprocessor controls are set at the factory and require no adjustment or periodic maintenance.

### Checkout

Use the following procedure to check out the TFA850.2 control after installation.

1. Flame failure — shut off oil supply hand valve while burner is on. The burner should immediately shut down. After the ignition timer recycles (approximately 60 seconds), the burner will attempt to restart. After 15 or 45 seconds depending on model, microprocessor locks out, ignition stops, motor stops, and oil valve closes. Safety switch must be reset.

2. Ignition and/or fuel failure — shut off oil supply while burner is off. Run through starting procedure, do not turn oil valve on. Safety switch locks out as in flame failure.

3. Power failure — turn off power supply while burner is on. When burner goes out, restore power and burner will restart after 15 second self-check delay.

4. If operation is not as described, check wiring and installation first. If trouble persists, follow the complete procedure for checking out the TFA850.2 and cad cell printed on the cover insert.

### CAUTION:

ONLY A TRAINED, EXPERIENCED SERVICE TECHNICIAN SHOULD ATTEMPT THE CHECKOUT PROCEDURE GIVEN ON THE INSERT.

**NOTE:** If you desire to trip the safety switch, run through the starting procedure below, omitting step 2. The switch will trip out on safety in 15 or 45 seconds, depending on model.



## STARTING PROCEDURE

### CAUTION:

Be sure combustion chamber is free of oil or vapor.

1. Push in and release red reset button.
2. Open hand valve in oil supply line.
3. Set thermostat to call for heat.
4. Close line switch.
5. Under normal conditions, burner operates until thermostat is satisfied.

## TFA 850.2 SEQUENCE OF RESET

### Reset Button:

- Pressing the reset button during \*MBFEB (lockout safety time) causes a restart with approximately 1-4 seconds self-check delay.
- Pressing the reset button during the run mode causes a restart with approximately 1-4 seconds self-check delay.
- Pressing the reset button during the recycle mode causes a restart with a full recycle delay.
- Pressing the reset button shortly after a safety lockout occurred causes a 1-4 seconds self-check delay, and then starts a 60-second scavenging delay.

### Power Off

- Power off and on during the \*MBFEP (lockout safety time) causes a restart with approximately 10-15 seconds self-check delay.
- Power off and on during recycle mode causes a new start of the recycle period.
- Power off and on during the run mode causes a restart with approximately 10-15 seconds self-check delay.
- Low voltage thermostat off and on during \*MBFEP (lockout safety time), causes the control to go through the 60 second recycle mode delay. This prevents short cycling of the burner.
- Low voltage thermostat off and on during run mode causes a restart with approximately 1-4 seconds self-check delay.

\*NOTE: "MBFEP" Main Burner Flame Establishment Period.

## SEQUENCE FOR BLEEDING PUMP

- Pressing the reset button during the \*MBFEP (lockout safety time) causes a restart with approximately 1-4 seconds self-check delay.

## SEQUENCE OF SAFETY TFA 850.2

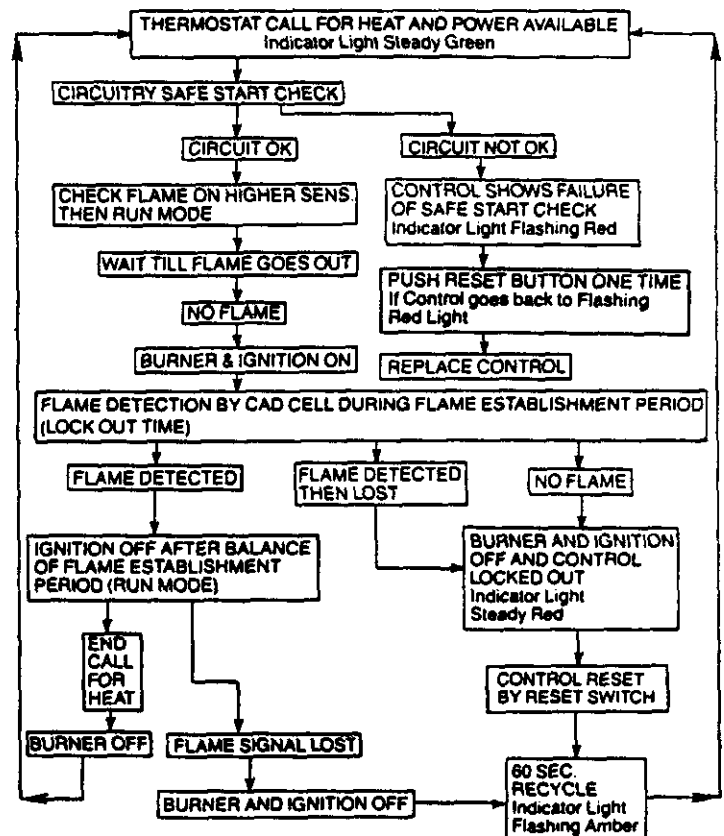

R.W. BECKETT CORPORATION

P.O. Box 1289 • Elyria, Ohio 44036