

INSTALLATION INSTRUCTIONS

MODELS

ECW-2B

ECW-3B

ECW-4B

**FOR USE WITH BARD 2 THRU 5 TON
WALL MOUNT AIR CONDITIONERS
AND HEAT PUMPS**

MANUAL 2100-165 REV. A
SUPERSEDES REV. NONE
FILE VOL. III, TAB 19

COPYRIGHT SEPTEMBER, 1989
BARD MANUFACTURING COMPANY
BRYAN, OHIO

INSTALLATION INSTRUCTIONS
FOR
ECONOMIZER MODELS ECW-2B, 3B, 4B FOR USE WITH BARD 2 TO 4
TON WALL MOUNT AIR CONDITIONERS AND HEAT PUMPS

GENERAL INFORMATION

THE ECONOMIZER SHOULD ONLY BE INSTALLED BY A TRAINED HEATING AND AIR CONDITIONING TECHNICIAN. THESE INSTRUCTIONS SERVE AS A GUIDE TO THE TECHNICIAN INSTALLING THE ECONOMIZER PACKAGE. THEY ARE NOT INTENDED AS A STEP BY STEP PROCEDURE WITH WHICH THE MECHANICALLY INCLINED OWNER CAN INSTALL THE PACKAGE.

THE ECONOMIZER IS SHIPPED IN ONE CARTON WHICH CONTAINS THE INTAKE HOOD WITH RETURN/OUTSIDE AIR DAMPER AND EXHAUST SUBASSEMBLY, ELECTRICAL HARNESS, MISCELLANEOUS HARDWARE AND INSTALLATION INSTRUCTIONS.

THE ECONOMIZER INSTALLATION REQUIRES AN ADDITIONAL TWO STAGE COOLING THERMOSTAT IN PLACE OF THE NORMAL SINGLE STAGE COOLING THERMOSTAT. ALSO ADDITIONAL LOW VOLTAGE WIRE WILL BE REQUIRED TO TRANSMIT THE SECOND CALL (Y2) FOR COOL. (I.E. USE 6 CONDUCTOR THERMOSTAT WIRE FOR AN AIR CONDITIONING UNIT AND 9 CONDUCTOR THERMOSTAT WIRE FOR HEAT PUMPS.)

THE ECONOMIZER INSTALLATION ALSO REQUIRES A FIELD SUPPLIED AND INSTALLED RETURN AIR FILTER AND FILTER GRILL. FRESH AIR ONLY IS FILTERED INTERNALLY BY THE ECONOMIZER.

UNPACKING

UPON RECEIPT OF THE EQUIPMENT BE SURE TO COMPARE THE MODEL NUMBER FOUND ON THE SHIPPING LABEL WITH THE ACCESSORY IDENTIFICATION INFORMATION ON THE ORDERING AND SHIPPING DOCUMENT TO VERIFY THAT THE CORRECT ACCESSORY HAS BEEN SHIPPED.

INSPECT THE CARTON HOUSING EACH ECONOMIZER AS IT IS RECEIVED, AND BEFORE SIGNING THE FREIGHT BILL, VERIFY THAT ALL ITEMS HAVE BEEN RECEIVED AND THAT THERE IS NO VISIBLE DAMAGE. NOTE ANY SHORTAGES OR DAMAGE ON ALL COPIES OF THE FREIGHT BILL. THE RECEIVING PARTY MUST CONTACT THE LAST CARRIER IMMEDIATELY, PREFERABLY IN WRITING, REQUESTING INSPECTION BY THE CARRIER'S AGENT. CONCEALED DAMAGE NOT DISCOVERED UNTIL AFTER LOADING MUST BE REPORTED TO THE CARRIER WITHIN 15 DAYS OF ITS RECEIPT.

DESCRIPTION

THE ECW-2B, 3B and 4B ECONOMIZERS ARE DESIGNED TO BE USED WITH BARD 2 TO 4 TON WALL MOUNT SERIES AIR CONDITIONERS AND HEAT PUMPS. THEY ARE ELECTRO-MECHANICAL ECONOMIZER SYSTEMS DESIGNED TO PROVIDE "FREE" COOLING WHERE THE OUTDOOR AIR TEMPERATURE IS COOL ENOUGH TO PROVIDE THE NEEDED COOLING WITHOUT RUNNING THE COMPRESSOR. WHEN COOLING IS NEEDED, THE SYSTEM AUTOMATICALLY TAKES ADVANTAGE OF THE COLD OUTDOOR AIR WHEN AVAILABLE AND USES IT FOR FIRST STAGE COOLING. THIS THEN REDUCES THE NEED TO RUN THE AIR CONDITIONING COMPRESSOR PROVIDING LOWER OPERATING COSTS AND INCREASING THE SERVICE LIFE OF THE EQUIPMENT. IF THE OUTDOOR AIR GETS TOO WARM OR HUMID TO BE HELPFUL, THE ENTHALPY CONTROL DETECTS THE CONDITION AND AUTOMATICALLY CLOSES THE OUTDOOR AIR AND EXHAUST DAMPER, OPENS THE RETURN AIR DAMPER AND SWITCHES TO THE COMPRESSOR OPERATION. THIS IS ALL DONE AUTOMATICALLY TO ACHIEVE MAXIMUM SAVINGS WITHOUT ATTENTION FROM THE USER. SEE FIGURE-1 FOR A BLOCK DIAGRAM OF THE ECONOMIZER OPERATION LOGIC FLOW. SEE PAGE 5 AND 6 FOR AIR FLOW PATH DETAILS THROUGH THE UNIT.

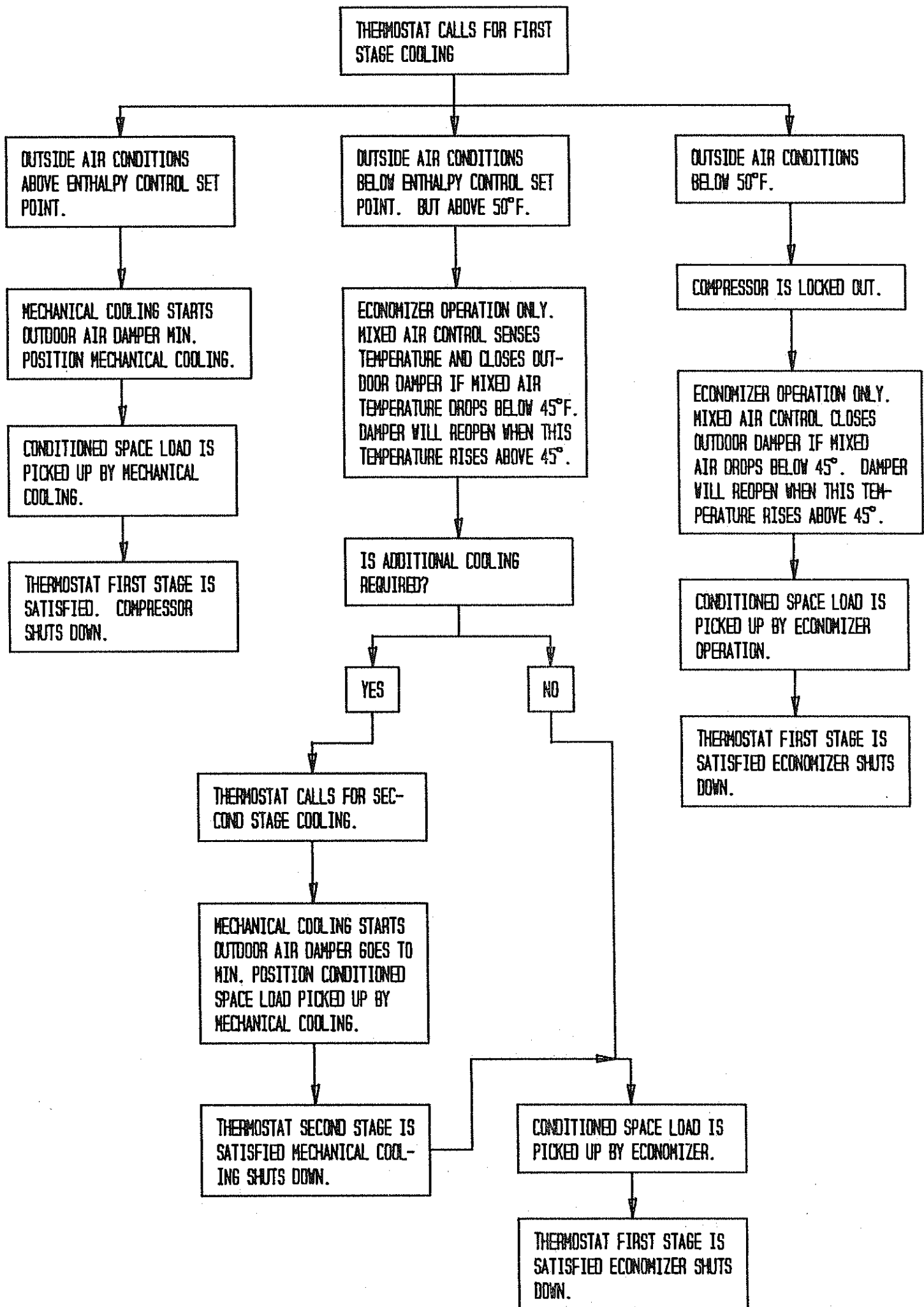

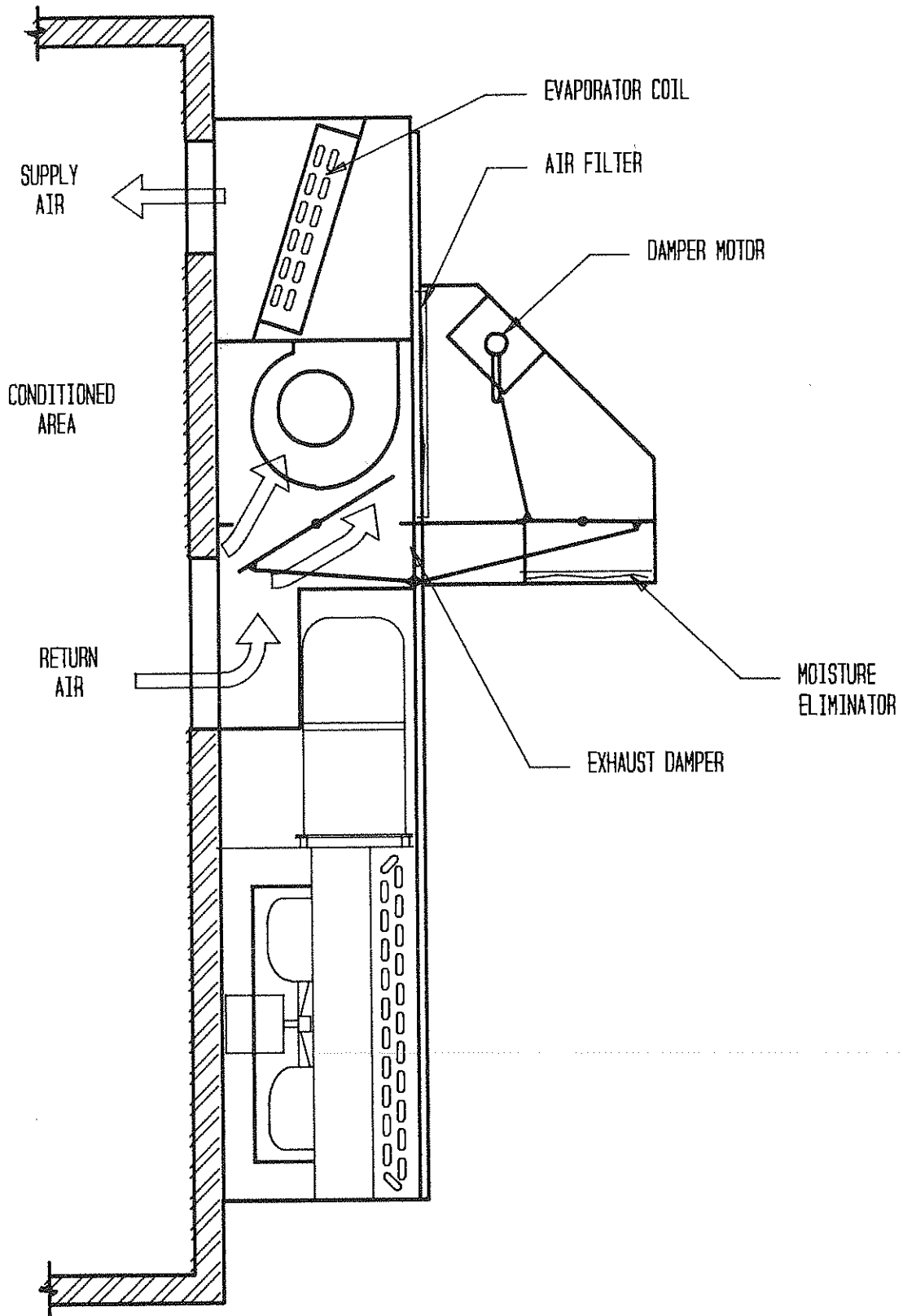

MECHANICAL COOLING MODE

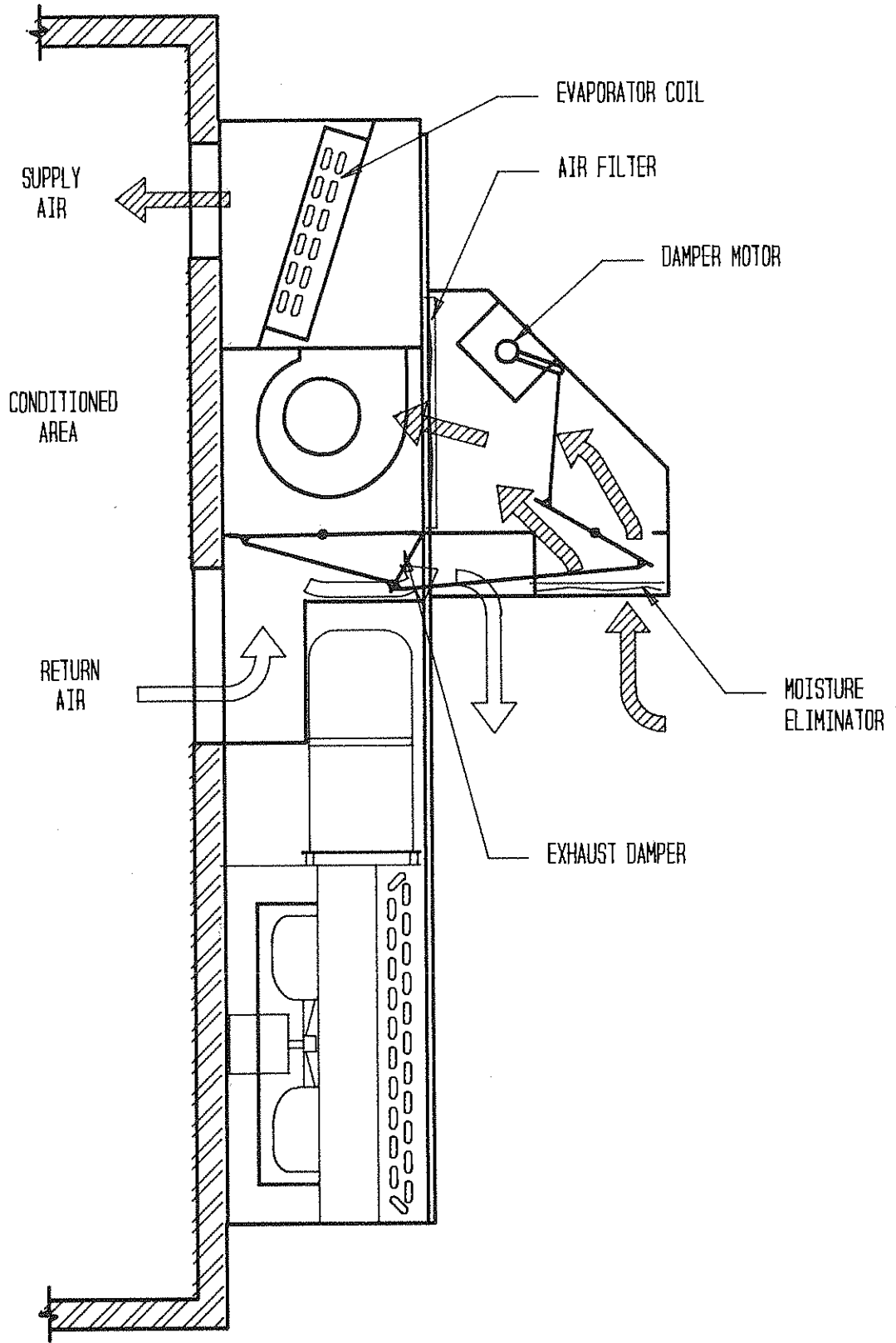

BASIC INSTALLATION

- 1.) UNPACK THE ECONOMIZER ASSEMBLY WHICH INCLUDES THE INTAKE HOOD, RETURN/OUTSIDE AIR EXHAUST DAMPER/FILTER RACK SUB-ASSEMBLY, ELECTRICAL HARNESS, BLOWER ACCESS PANEL, SERVICE ACCESS PANEL, MISCELLANEOUS HARDWARE AND INSTALLATION INSTRUCTIONS. (SEE FIGURE 2)

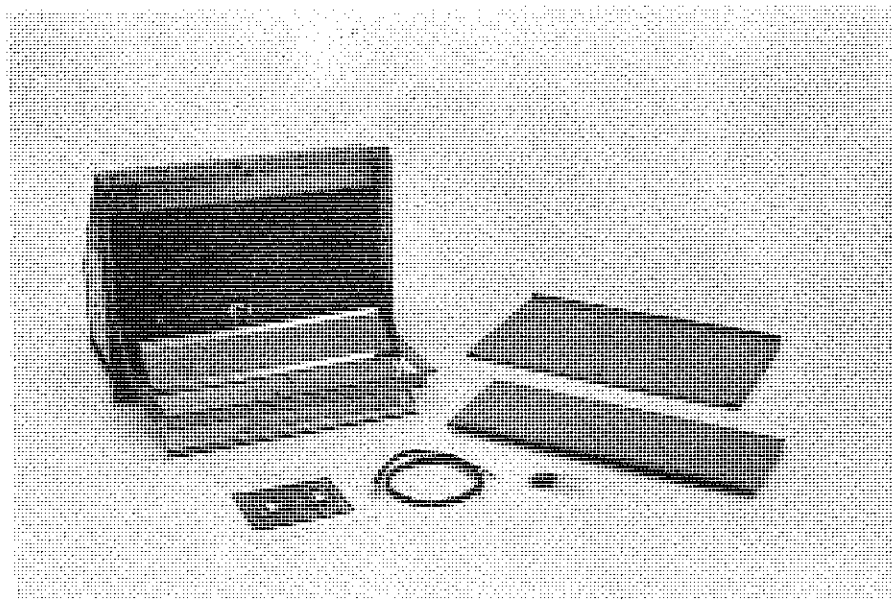

FIGURE 2

WARNING:

OPEN AND LOCK UNIT DISCONNECT SWITCH BEFORE INSTALLING THIS ACCESSORY TO PREVENT INJURY OR DEATH DUE TO ELECTRICAL SHOCK OR CONTACT WITH MOVING PARTS. TURN THERMOSTAT TO OFF.

- 2.) REMOVE AND DISCARD THE EXISTING EXTERIOR BLOWER ACCESS AND SERVICE ACCESS PANELS ON THE BARD HIGH-BOY UNITS.
(SEE FIGURE 3)

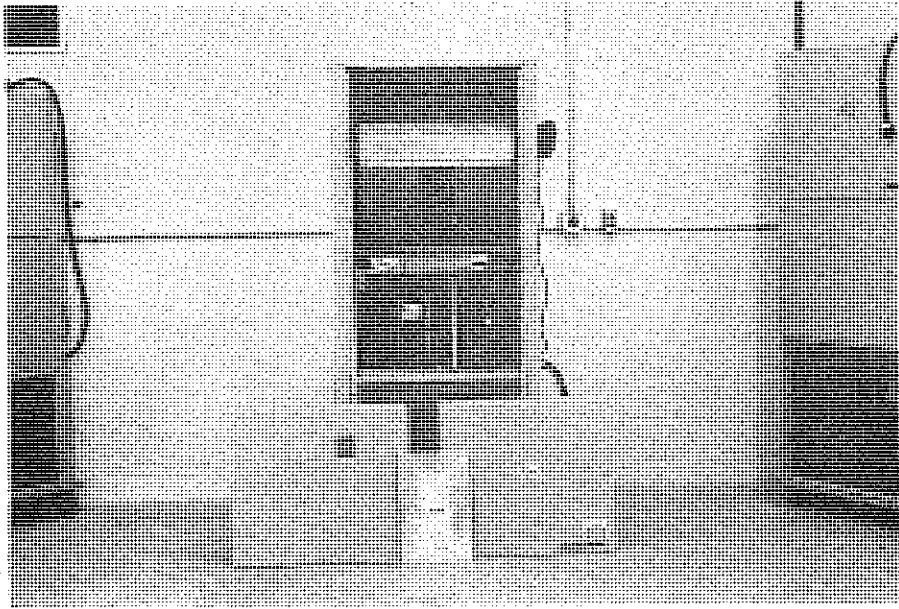

FIGURE 3

- 3.) REMOVE AND SAVE EXISTING UNIT RETURN AIR FILTER. IN THE EVENT SOME 2 & 3 TON UNITS ARE EQUIPPED WITH CONTROL MODULE OPTION, MOVE MODULE FROM TOP OF COMPRESSOR PARTITION TO BACK OF PARTITION TO ALLOW ROOM FOR ECONOMIZER INSERTION (SEE FIGURES 3 & 4). ACCESS TO THE MODULE CAN NOW ONLY BE MADE FROM INSIDE THE BUILDING BY REMOVING THE FILTER GRILL OR BY PROVIDING AN ACCESS PLATE IN THE RETURN AIR DUCTWORK.

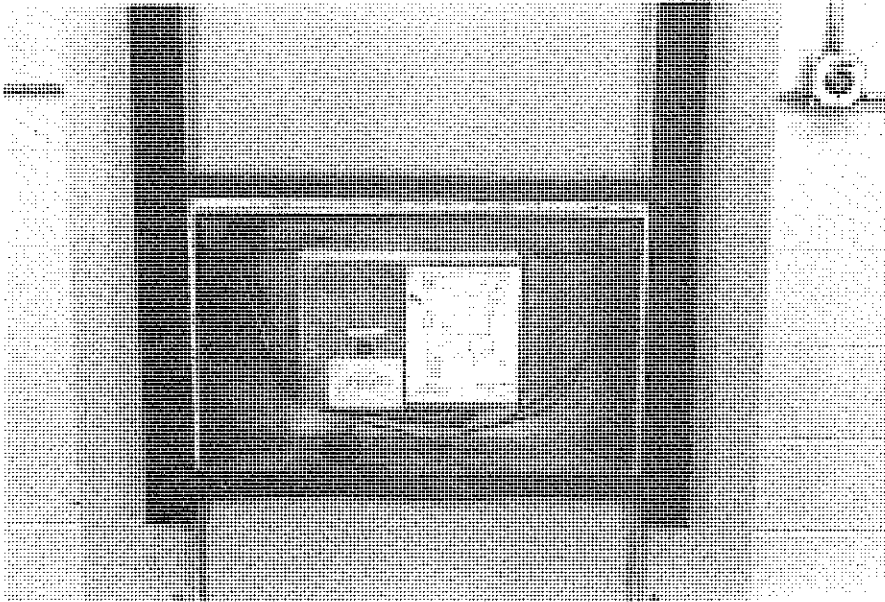

FIGURE 4

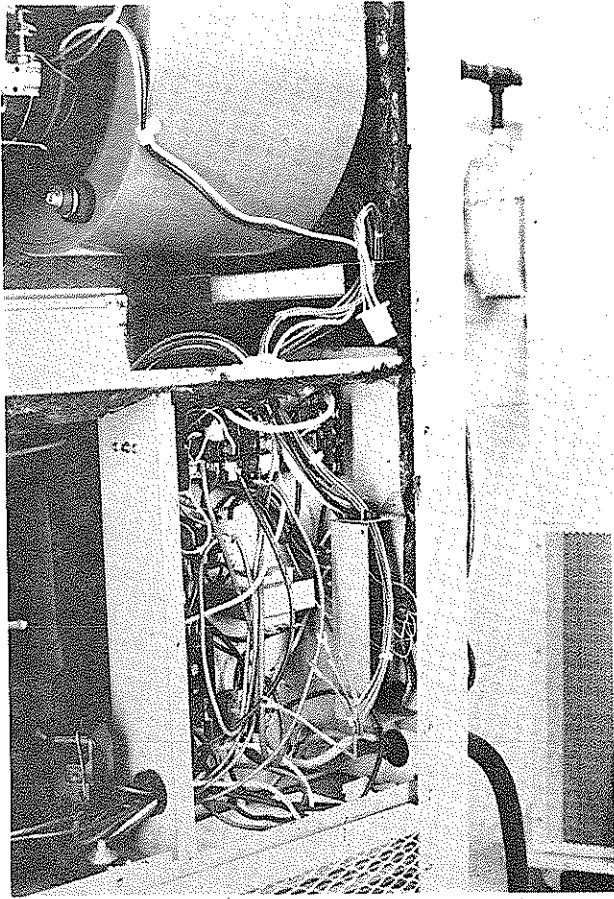

FIGURE 5

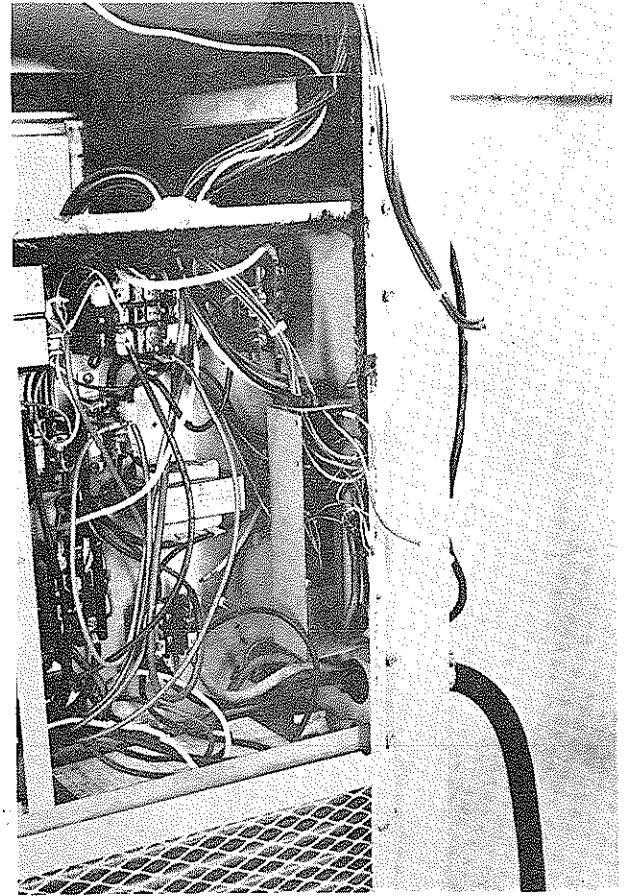

FIGURE 6

IMPORTANT:

WHEN RELOCATING MODULAR CONTROL BOX, POSITION BOX ON PARTITION LOW ENOUGH TO ALLOW DAMPER TO FULLY OPEN. CARE MUST BE TAKEN IN SECURING CONTROL BOX TO INSURE SCREWS DO NOT PUNCTURE COPPER TUBES ON OTHER SIDE OF PARTITION.

- 4.) OPEN CONTROL PANEL IN ORDER TO ALLOW ACCESS TO UNIT LOW VOLTAGE TERMINAL BLOCK.
- 5.) ROUTE ELECTRICAL HARNESS LEADS DOWN THRU THE (2) 1½" Ø SNAP BUSHINGS IN FILTER BACK AND CONTROL PANEL AND THRU 7/8" Ø SNAP BUSHING INTO LOW VOLTAGE BOX.
- 6.) CONNECT LEADS WITH FORK TERMINALS TO CORRESPONDING POINTS ON TERMINAL STRIP, I.E., T,Y,G. (SEE FIGURE 6)
- 7.) WIRE NUT LEADS WITH 5/8" STRIPPED ENDS TO Y1, and Y2 LEADS FROM THERMOSTAT. (SEE FIGURE 6)

- 8.) CLOSE CONTROL PANEL COVER.
- 9.) ON 3 AND 4 TON UNITS, CUT AND REMOVE FILTER RACK ACROSS WIDTH OF UNIT. (SEE DETAIL PAGE 11)
- 10.) INSTALL NEW SERVICE ACCESS PANEL. SECURE WITH SCREWS.
(SEE FIGURE 7)

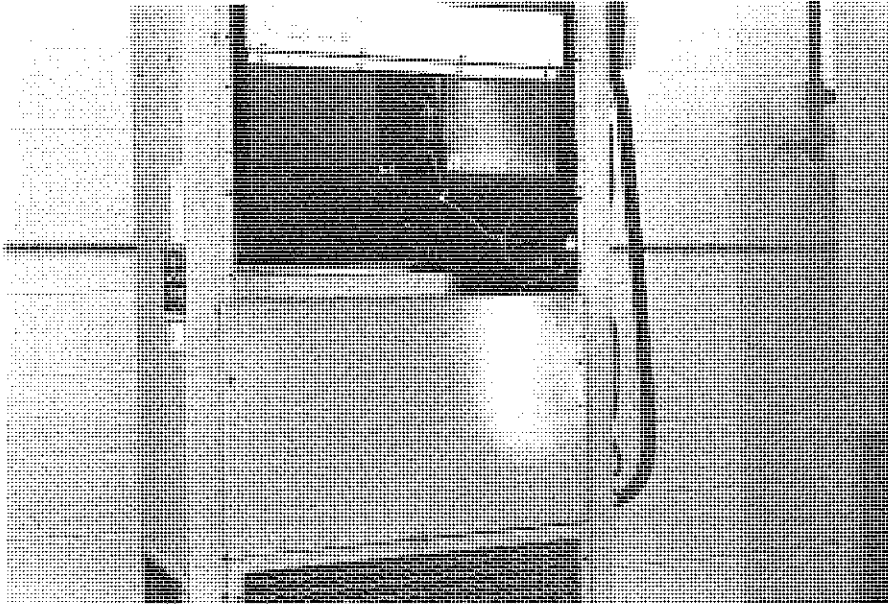

FIGURE 7

- 11.) INSTALL ECONOMIZER ASSEMBLY BY INSERTING RETURN AIR DAMPER INTO UNIT WITH SIDE ANGLE ON TOP OF FILTER RACK. TAKE CARE NOT TO DAMAGE WIRING WITH R/A BLADE. CONNECT MALE LEAD FROM ECONOMIZER TO FEMALE HARNESS AT THIS TIME. PUSH ASSEMBLY HOME TO UNIT AND SECURE THROUGH SIDE FLANGES WITH SHEET METAL SCREWS.

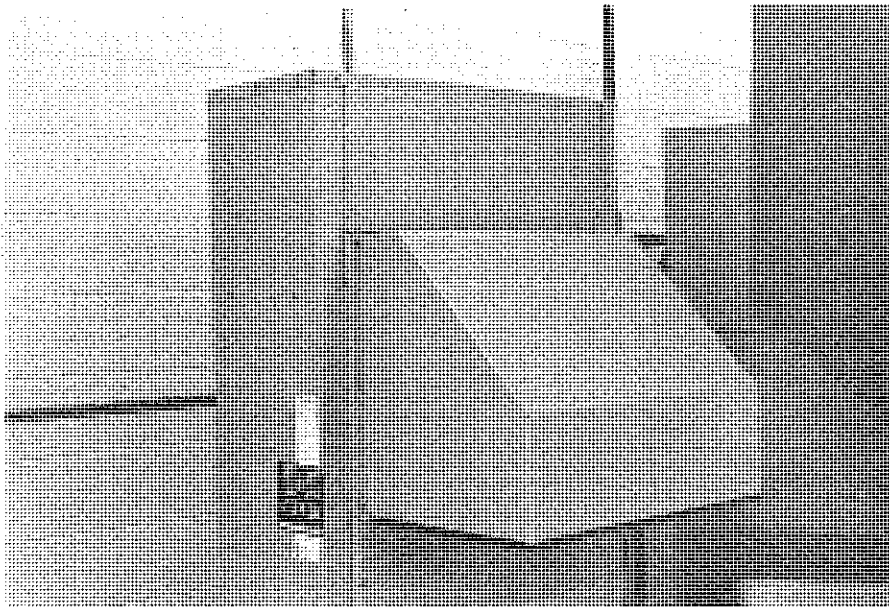
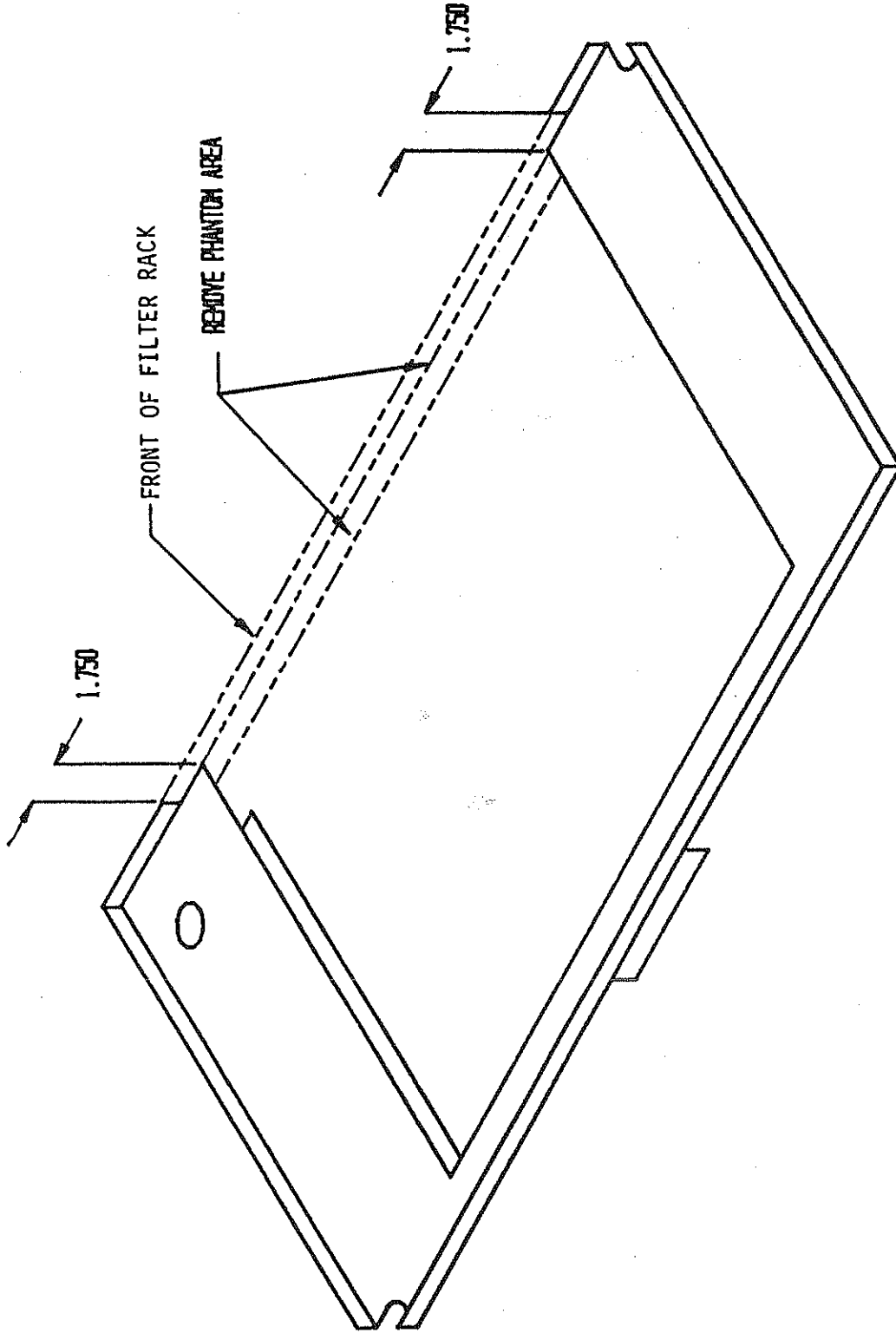

FIGURE 8

FILTER RACK MODIFICATION INSTRUCTIONS
FROM STEP 9 IN INSTALLATION INSTRUCTIONS
FOR 3 AND 4 TON UNITS.



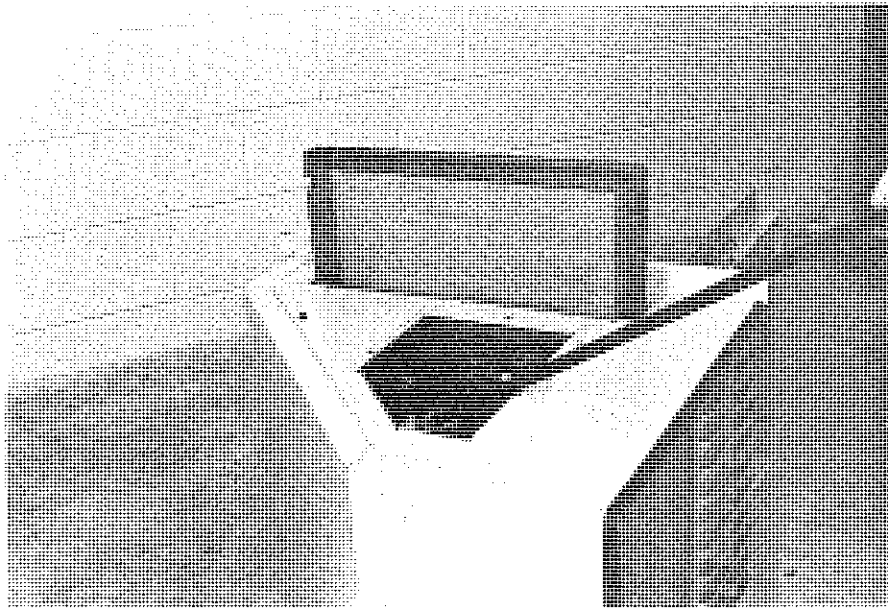

FIGURE 9

- 12.) INSTALL NEW BLOWER ACCESS PANEL AT TOP OF UNIT AND SECURE WITH SHEET METAL SCREWS.
- 13.) REMOVE FILTER ACCESS AND CONTROL ACCESS PANELS ON SIDE OF INTAKE HOOD OF ECONOMIZER ASSEMBLY. (SEE FIGURE 9) REMOVE MOISTURE ELIMINATOR UNDER INTAKE HOOD OF ECONOMIZER. (SEE FIGURE 10)
- 14.) INSTALL EXISTING UNIT FILTER SAVED FROM STEP 3 IN ECONOMIZER FILTER RACK AND REPLACE FILTER ACCESS COVER.

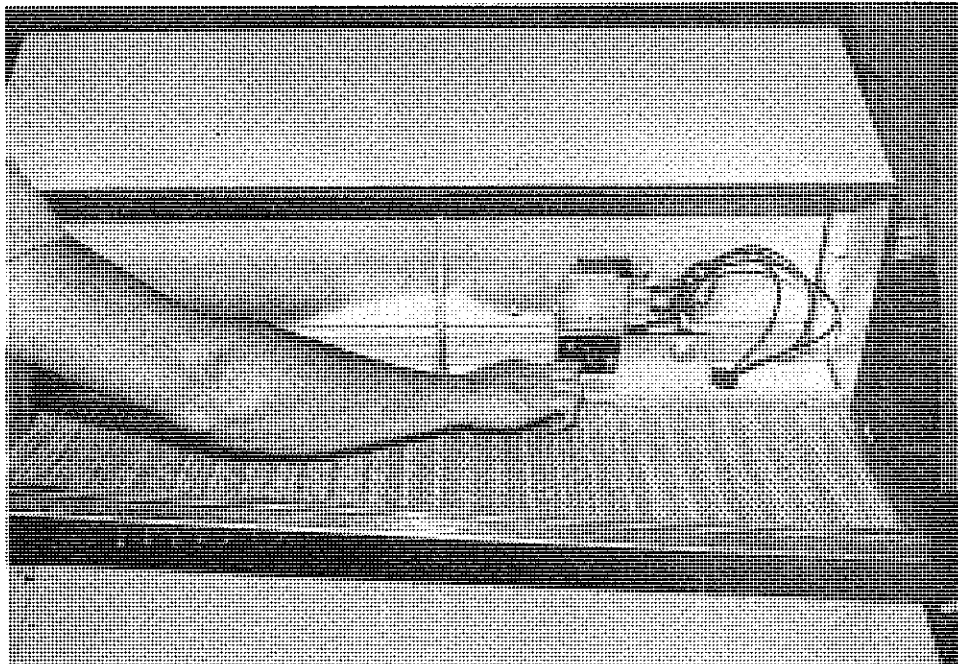

FIGURE 10

4.) ECONOMIZER CHECKOUT

- A.) LOCATE THE MINIMUM POSITION LEVER ON THE MOTOR (SEE ENCLOSED MANUFACTURERS LITERATURE) LOCATED ABOVE WIRING TERMINALS, (FIGURE 9).
- B.) ENERGIZE THE EVAPORATOR BLOWER BY SWITCHING THE THERMOSTAT TO THE MANUAL FAN POSITION WITH THE HEAT/COOL SWITCH IN THE OFF POSITION.
- C.) CYCLE THE MINIMUM POSITION LEVER (FACTORY SET FOR 0% FRESH AIR) 0 TO FULL OPEN. (SEE FIGURE 9) THROUGHOUT CHECKOUT PROCEDURE OBSERVE OPERATION OF DAMPER TO INSURE THERE IS FREE, UNOBSTRUCTED OPERATION THROUGH THE ENTIRE RANGE OF DAMPER TRAVEL. THEN ADJUST THE DAMPER MINIMUM OPEN POSITION TO MEET LOCAL CODES OR APPLICATION REQUIREMENTS. (SEE EXAMPLE BELOW)

EXAMPLE: MINIMUM FRESH AIR INTAKE CALCULATION FOR

- 1) MEASURE RETURN AIR TEMPERATURE (RAT) (ASSUME 75°F FOR EXAMPLE.)
- 2) MEASURE OUTDOOR AIR TEMPERATURE (OAT) (ASSUME 60°F FOR EXAMPLE.)
- 3) CALCULATE THE MIXED AIR TEMPERATURE (MAT) WHICH WILL RESULT FROM THE DESIRED COMBINATION OF OAT (10 PERCENT) AND RAT (90 PERCENT).

$$.1 \text{ OAT} + .9 \text{ RAT} = \text{MAT}$$

OR SUBSTITUTING EXAMPLE VALUES

$$.1 (60 \text{ F}) + .9 (75^\circ \text{F}) = 73.5 \text{ F}$$

- 4) ADJUST THE MINIMUM POSITION POTENTIOMETER KNOB UNTIL PROPER MIXED AIR TEMPERATURE AS CALCULATED ABOVE IS REACHED. CARE SHOULD BE TAKEN TO INSURE THERMOMETER IS SENSING AIR THAT IS WELL MIXED.
 - 5) MARK CORRECT SETTING OF LEVER ON MOTOR HOUSING FOR FUTURE REFERENCE.
- D.) LOCATE THE MIXED AIR THERMOSTAT LOCATED ABOVE RETURN AIR DAMPER AND ADJUST MIXED AIR THERMOSTAT (FACTORY SET AT 45°F) TO INSURE DESIRED MINIMUM TEMPERATURE TO MEET LOCAL CODES OR APPLICATION CRITERIA. (DO NOT CONFUSE THIS WITH MAT CALCULATED ABOVE.) THIS IS THE MINIMUM TEMPERATURE OF

FRESH AIR COOLING DESIRED WHEN UNIT IS IN ECONOMIZER MODE AND IS TYPICALLY DESIRED TO BE 45°F TO 60°F.)

- E.) LOCATE THE ENTHALPY CONTROL ADJUSTMENT KNOB ON ENTHALPY CONTROL IN ECONOMIZER INTAKE HOOD (FIGURE 10).
- F.) ADJUST THE ENTHALPY CONTROL TO POSITION A,B,C,D, TO ACHIEVE THE MAXIMUM COMBINATION OF TEMPERATURE AND HUMIDITY ACCEPTABLE FOR THE INSTALLATION AS PER THE CHART IN MANUFACTURERS ENCLOSED INSTRUCTIONS. (THE SUGGESTED SETTING IS BETWEEN A & B 70°DB @ 55 PERCENT RH. IT IS FURTHER RECOMMENDED TO ALWAYS SET THE CONTROL AT C OR ABOVE (FIGURE 10)).
- G.) SWITCH THE THERMOSTAT FAN CONTROL TO AUTOMATIC AND POSITION THE HEAT COOL SWITCH TO COOL. ADJUST THE THERMOSTAT TEMPERATURE TO ENGAGE THE FIRST STAGE OF COOLING ONLY (Y). THIS WILL CAUSE THE DAMPERS TO FULLY OPEN TO PROVIDE 100% OUTSIDE AIR PROVIDED OUTSIDE AIR ENTHALPY IS SUFFICIENTLY LOW. IF ENTHALPY IS TOO HIGH FOR ECONOMIZING, LOW ENTHALPY CAN BE SIMULATED BY TEMPORARILY REMOVING AND JUMPING LEADS ON TERMINAL 2 AND 3 OF ENTHALPY CONTROL TOGETHER. THIS WILL ALSO CAUSE THE ECONOMIZER DAMPER TO MODULATE AWAY FROM MINIMUM POSITION (BE SURE TO PROPERLY RECONNECT LEADS AT END OF CHECKOUT PROCEDURE).
- H.) READJUST TEMPERATURE ON THE THERMOSTAT TO ENGAGE THE SECOND STAGE OF COOLING (Y2). THE DAMPER MOTOR SHOULD RETURN TO PREVIOUSLY SET MINIMUM POSITION.
- I.) SWITCH THERMOSTAT TO OFF FAN AND OFF HEAT/COOL POSITIONS TO DE-ENERGIZE UNIT. ECONOMIZER DAMPER SHOULD RETURN TO FULL CLOSED (100% RETURN AIR) POSITION. CHECKOUT IS COMPLETE.
- 15.) INSTALL EXISTING UNIT FILTER SAVED FROM STEP 3 IN ECONOMIZER FILTER RACK AND REPLACE FILTER ACCESS COVER.
- 16.) REPLACE CONTROL ACCESS PANEL ON SIDE OF INTAKE HOOD AND MIST ELIMINATOR.
- 17.) ECONOMIZER IS NOW READY FOR OPERATION.

HEAT PUMP CONNECTION DIAGRAM

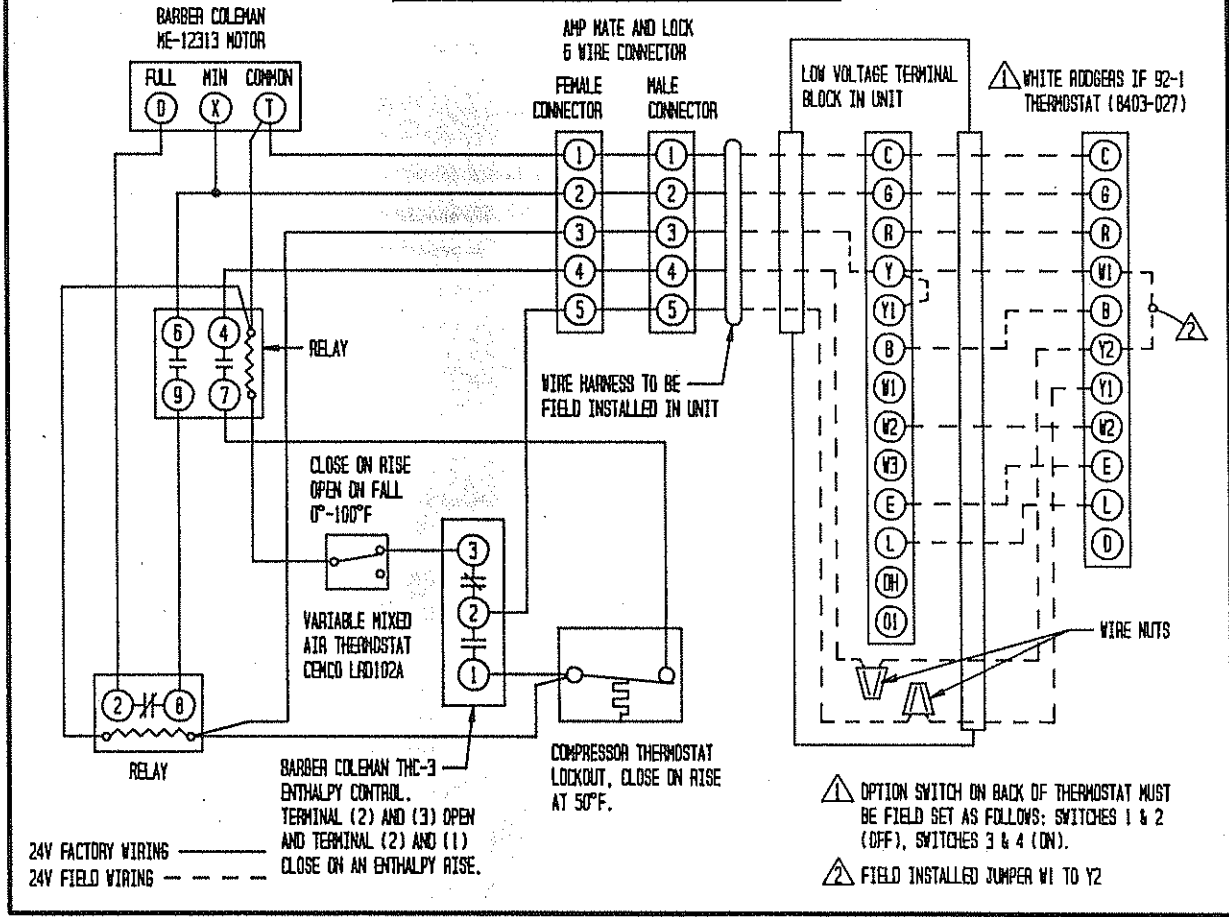

AIR CONDITIONER CONNECTION DIAGRAM

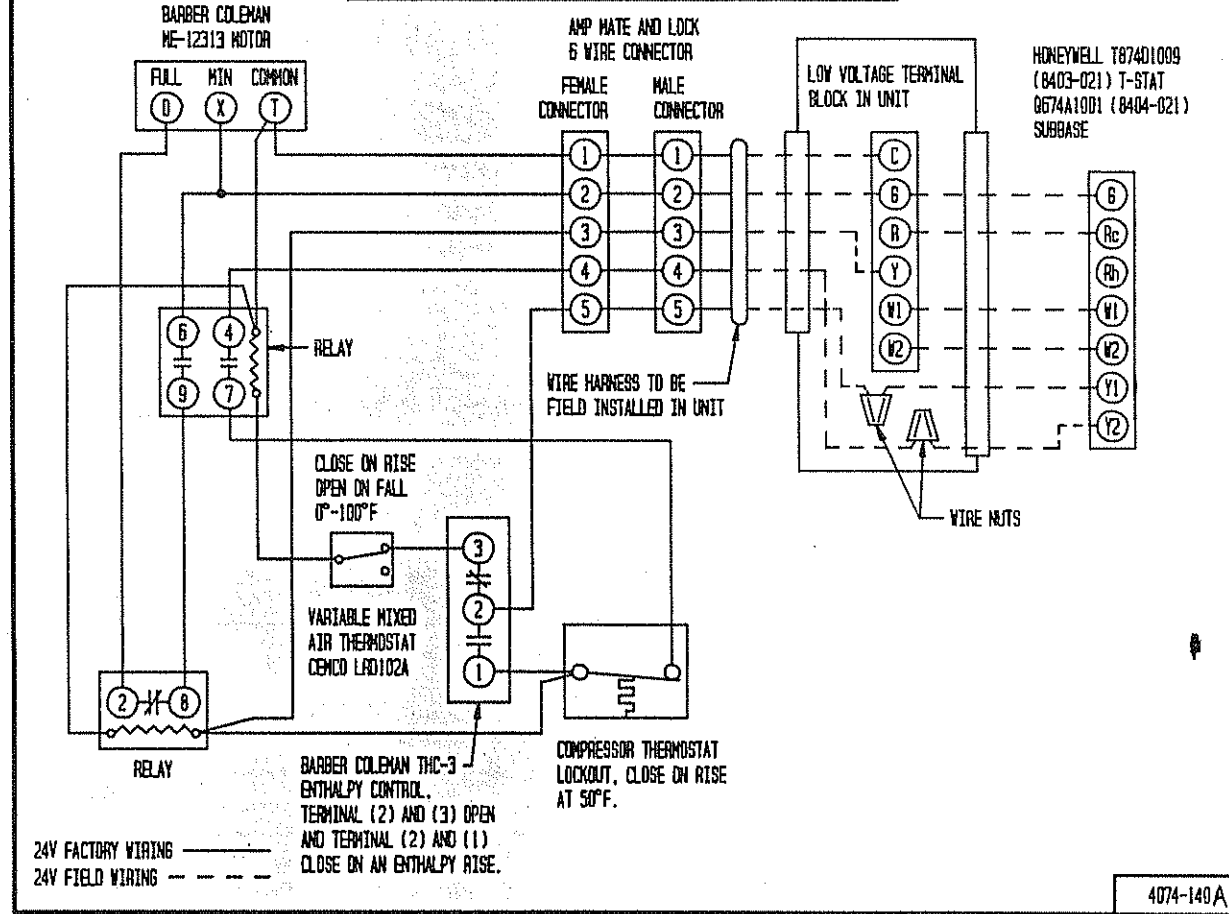

ECONOMIZER CONTROL CIRCUIT LADDER DIAGRAM & SEQUENCE CHART

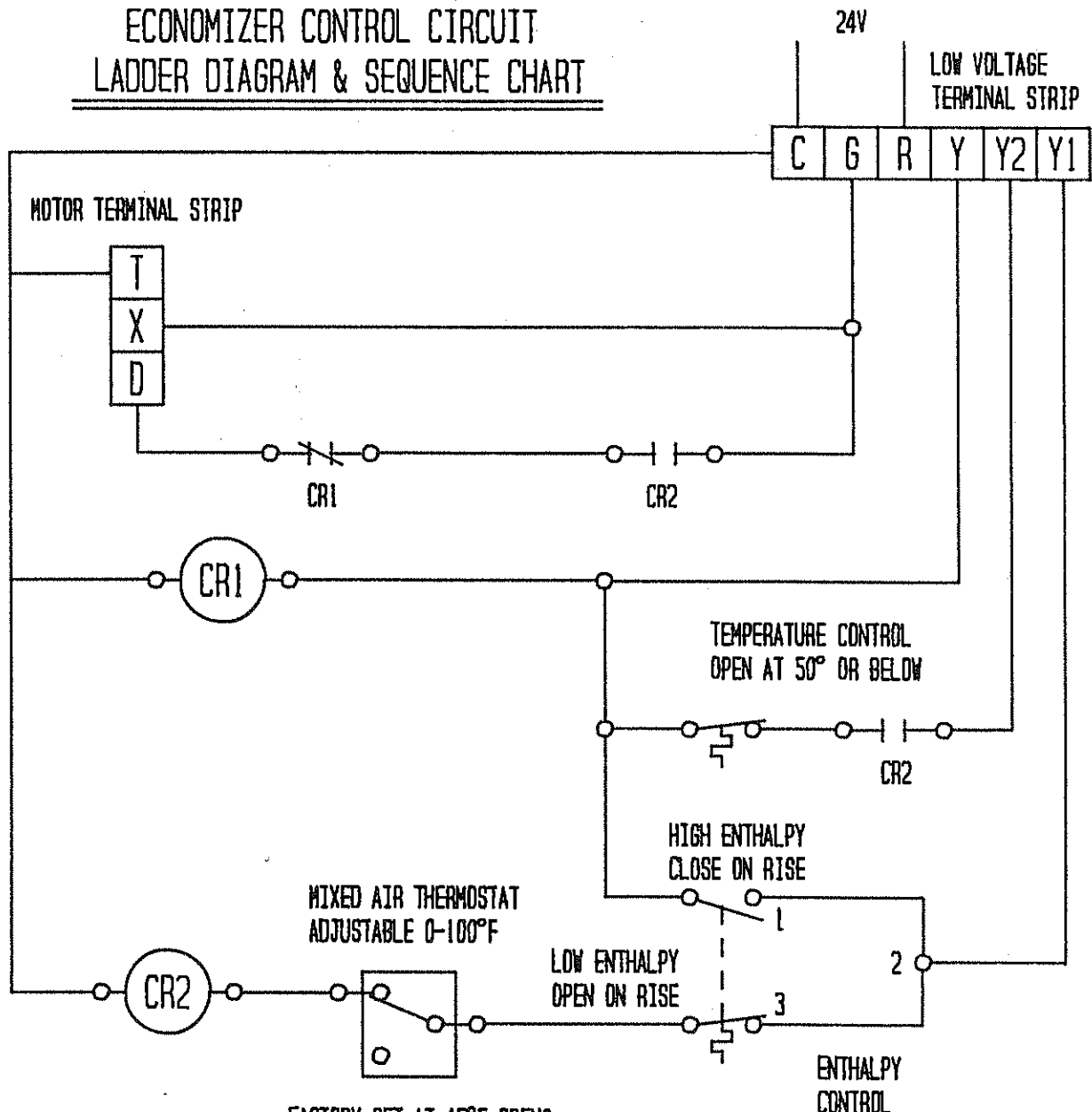

FACTORY SET AT 45°F OPENS ON FALL, CLOSES ON RISE FROM SET POINT.

OUTDOOR CONDITIONS	HIGH TEMPERATURE HIGH ENTHALPY	HIGH TEMPERATURE LOW ENTHALPY	LOW TEMPERATURE LOW ENTHALPY
ENTHALPY CONTROL (LOW)	OPEN	CLOSED	CLOSED
ENTHALPY CONTROL (HIGH)	CLOSED	OPEN	OPEN
TEMPERATURE CONTROL	CLOSED	CLOSED	OPEN
CR1	ENERGIZED	DE-ENERGIZED	DE-ENERGIZED
CR2	DE-ENERGIZED	ENERGIZED	ENERGIZED
FIRST STAGE COOLING	COMPRESSOR	ECONOMIZER	ECONOMIZER
SECOND STAGE COOLING	—	COMPRESSOR	—

ECONOMIZER
(WA & WH SERIES)

FEATURES:

- . ONE PIECE CONSTRUCTION - EASY TO INSTALL WITH NO MECHANICAL LINKAGE ADJUSTMENT REQUIRED.
- . EXHAUST AIR DAMPER - BUILT IN WITH POSITIVE CLOSED POSITION. PROVIDES EXHAUST AIR CAPABILITY TO PREVENT PRESSURIZATION OF TIGHT BUILDINGS.
- . ACTUATOR MOTOR - 24 VOLT, POWER OPEN, SPRING RETURN WITH BUILT IN TORQUE LIMITING SWITCH.
- . MAXIMUM "FREE COOLING" ECONOMY AND COMFORT WITH UP TO 100% OUTSIDE Air.
- . ADJUSTABLE MIXED AIR - SET POINT-ADJUSTABLE FROM 0 DEGREE TO 100 DEGREE (FACTORY SET AT 45 DEGREES).
- . MOISTURE ELIMINATOR & PRE-FILTER PERMANENT, WASHABLE ALUMINUM CONSTRUCTION.
- . ENTHALPY CONTROL TO MONITOR OUTDOOR TEMPERATURE AND HUMIDITY - ADJUSTABLE.
- . MINIMUM POSITION POTENTIOMETER - ADJUSTABLE TO CONTROL MINIMUM DAMPER BLADE POSITION.
- . MIXED THERMOSTAT TO MONITOR OUTDOOR & RETURN AIR TO AUTOMATICALLY CONTROL DAMPER POSITION.
- . PLUG-IN WIRE HARNESS FOR EASY INSTALLATION AND SERVICE.

ECONOMIZER SEQUENCE OF OPERATION

CONDITION A - COOL OUTDOORS

1ST STAGE COOLING CLOSES AND POWERS THE ECONOMIZER DAMPERS TO ECONOMIZER MODE AND THE INDOOR BLOWER STARTS. MIXED AIR THERMOSTAT SENSES A MIXTURE OF RETURN AIR AND OUTDOOR AIR AND CONTROLS THE DAMPERS ACCORDINGLY. COMPRESSOR OPERATION IS INHIBITED.

IF SECOND STAGE CLOSES ON THE THERMOSTAT, THE DAMPERS RETURN TO THE CLOSED OR MINIMUM POSITION SETTING AND THE COMPRESSOR STARTS FOR MECHANICAL COOLING.

COMPRESSOR LOCKOUT THERMOSTAT IS FACTORY SET AT 50 F OUTDOOR TEMPERATURE.

CONDITION B - WARM OUTDOORS

1ST STAGE COOLING CYCLES THE COMPRESSOR AND DAMPERS REMAIN IN THE MECHANICAL COOLING MODE.

WALL THERMOSTATS

FOR HEAT PUMPS
WITH ECONOMIZER

THERMOSTAT, PART NO. 8403-027
(WHITE RODGERS IF92-1)
ELECTRIC HEAT PUMP THERMOSTAT
2 STAGE COOL/3 STAGE HEAT

FOR AIR CONDITIONING
WITH ECONOMIZER

THERMOSTAT, PART NO. 8403-021
(HONEYWELL T874D 1009)
SUBBASE, PART NO. 8404-012
(HONEYWELL Q674A1001)
2 STAGE COOL/2 STAGE HEAT

ECONOMIZER
MODEL

ECW-2B
ECW-3B
ECW-4B

BASIC AIR CONDITIONER OR
HEAT PUMP MODEL

20WA, 24WA, 18WH, 24WH
30WA, 36WA, 30WH, 36WH
42WA, 49WA, 60WA, 42WH, 48WH, 60WH