

# **INSTALLATION INSTRUCTIONS**

## **SPLIT AIR CONDITIONER OUTDOOR SECTION**

### **MODELS**

**2412UACSA  
3012UACSA  
3612UACSA  
4212UACSA  
4812UACSA  
6012UACSA  
6012UACQA**

**FOR USE WITH:  
MATCHING INDOOR BLOWER  
COIL UNITS AND MATCHING  
ADD ON COIL UNITS ONLY**

**MANUAL 2100-169D  
SUPERSEDES REV. C  
FILE VOL. 1, TAB 4**

COPYRIGHT FEBRUARY, 1990  
BARD MANUFACTURING COMPANY  
BRYAN, OHIO

## TABLE OF CONTENTS

I.	Application and Location . . . . .	4
	General . . . . .	4
	Shipping Damage . . . . .	4
	Application . . . . .	4
	Location . . . . .	5
	Mounting Unit Outside on Slab . . . . .	5
	Indoor Coil . . . . .	5
	Important Installer Note . . . . .	5
	Installing Refrigerant Tubing . . . . .	5
	1. Sweat Style Tubing Connections. . . . .	6
II.	Wiring Instructions . . . . .	7
	General . . . . .	7
	Discharge Temperature Sensor (2412- 4212 Models) . . . . .	7
	Wall Thermostats . . . . .	8
III.	Charging Instructions . . . . .	8
	Pressure Service Ports . . . . .	8
	System Start-Up . . . . .	8
	Refrigerant Charge Checking . . . . .	9
IV.	Service . . . . .	11
	Service Hints . . . . .	11
	Fan Blade Setting Dimensions . . . . .	11
	Unbrazing System Components . . . . .	11
	Wiring Diagrams . . . . .	12-13
	Pressure Tables . . . . .	14-19

## FIGURES AND TABLES

Figure 1 . . . . .	1
Figure 2 . . . . .	4
Figure 3 . . . . .	5
Figure 4 . . . . .	7
Figure 5 . . . . .	7
Figure 6 . . . . .	11

Table 1 . . . . .	1
Table 2 . . . . .	2
Table 3 . . . . .	3
Table 4 . . . . .	6
Table 5 . . . . .	8
Table 6 . . . . .	9
Table 7 . . . . .	9
Table 8 . . . . .	10
Table 9 . . . . .	11
Table 10 . . . . .	14
Table 11 . . . . .	15
Table 12 . . . . .	16
Table 13 . . . . .	17
Table 14 . . . . .	18
Table 15 . . . . .	19

FIGURE 1

NOMENCLATURE EXPLANATION - Example:

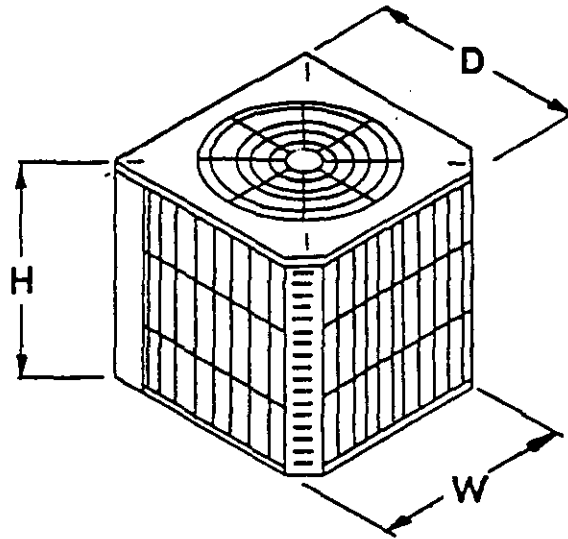
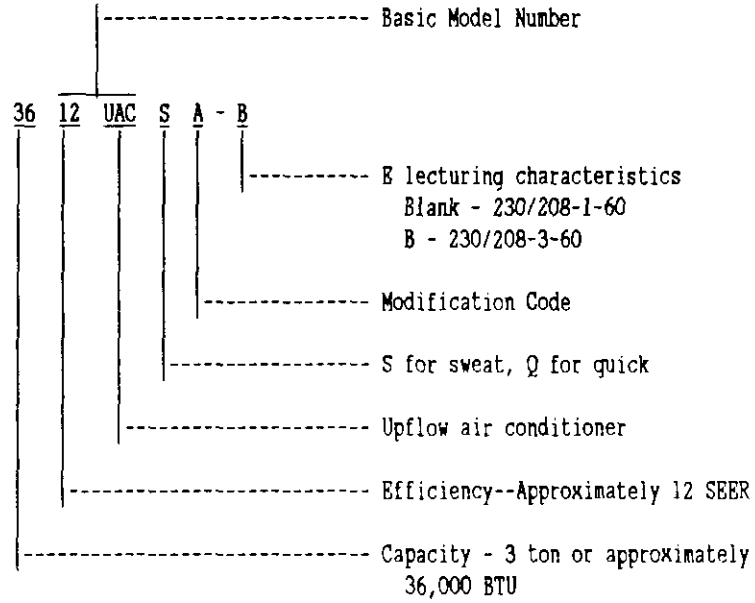

TABLE 1

DIMENSIONS			
Basic Model No.	"W" Width	"D" Depth	"H" Height
2412UACSA 3012UACSA 3612UACSA	32-1/2	32-1/2	26"
4212UACSA 4812UACSA 6012UACSA, QA	32-1/2	32-1/2	36"

TABLE 2  
RATED CFM AND AIR FLOW DATA (WET COIL--COOLING)

Condensing Unit Model Number	Evaporator Coil Model Number	Rated Airflow		Rated E.S.P. (2)	Motor Speed Tap	Recommended Air Flow Range	System Orifice Required
		CFM	Pressure Drop H <sub>2</sub> O (1)				
2412UACSA	A36AS-A	820	.15	.15	High	700 - 910	.061*
	BC24B	775				680 - 890	.059
3012UACSA	A36AS-A	1050	.20	.10 .21	High Low	900 - 1325	.067
	BC30B	800				700 - 910	.063
	BC36B	1050				900 - 1325	.067*
3612UACSA	A36AS-A	1200	.30	.20	High	1020 - 1320	.072*
	A37AS-A	1200	.25			1020 - 1320	.072
	BC36B	1200				1020 - 1320	.072
4212UACSA	A48AS-A	1325	.20	.15	High	1125 - 1450	.081
	BC36B	1240				1060 - 1360	.081*
4812UACSA	A61AS-A	1600	.25	.40 .38	High Low	1360 - 1760	.085*
	BC48B	1600				1360 - 1760	.085*
	BC60B	1600				1360 - 1760	.085*
6012UACSA, QA	A61AS-A, AQ-A	1725	.30	.30	High	1485 - 1925	.092
	BC60B	1800				1525 - 1975	.092

(1) Measured across the evaporator coil assembly, including drain pan.  
(2) External static pressure available for the duct system - supply and return. All blower coils have multi-speed motors, and value shown is at the recommended rated speed. Consult specification air flow charts with the blower coil units for complete information at other speeds.

**\*IMPORTANT**

Proper sized orifice is not factory installed in indoor section. Proper orifice size is shipped with outdoor unit packaged with its installation instructions. The orifice must be replaced with the proper system orifice shown above in Table 2.

TABLE 3  
SPECIFICATIONS--SPLIT AIR CONDITIONING

MODEL	2412UACSA	3012UACSA	3612UACSA	4212UACSA	4812UACSA	6012UACSA
ELECTRICAL RATING (60Hz/V/Ph)	230/208-1	230/208-1	230/208-1	230/208-1	230/208-1	230/208-1
Operating Voltage Range	197-253	197-253	197-253	197-253	197-253	197-253
Minimum Circuit Ampacity	16	18	24	27	31	38
*Field Wire Size	#14	#12	#10	#10	#8	#8
**Delay Fuse Max. or Ckt. Bkr.	25	30	40	45	50	60
Total Unit Amps 230/208	9.1/10.1	11.6/12.1	14.1/14.6	18.5/17.5	21/22.4	24.7/26.8
<b>COMPRESSOR</b>						
Volts	230/208	230/208	230/208	230/208	230/208	230/208
Rated Load Amps 230/208	8/9	10.5/11	13/13.5	17/16	19.8/21.2	23.5/25.6
Branch Circuit Selection Current	11.6	13.5	18	20	23.7	28.8
Lock Rotor Amps 230/208	62.5/62.5	76/76	90.5/90.5	107/107	129/129	169/169
<b>FAN MOTOR &amp; CONDENSER</b>						
Fan Motor--HP/RPM	1/6 - 825	1/6 - 825	1/6 - 825	1/4 - 825	1/3 - 1075	1/3 - 1075
Fan Motor--AMPS	1.1	1.1	1.1	1.5	1.2	1.2
Fan--DIA/CFM	24" - 3000	24" - 3000	24" - 3000	24" - 3100	24" - 3100	24" - 3100
<b>REFRIGERANT CONNECTION AND CHG.</b>						
Suction Line Size	7/8"	7/8"	7/8"	7/8"	7/8"	7/8"
Liquid Line Size	3/8"	3/8"	3/8"	3/8"	3/8"	3/8"
*60 degree C Copper wire size.						
**Maximum time delay fuse or HACR Type circuit breaker.						

## I. APPLICATION AND LOCATION

### GENERAL

These instructions explain the recommended method to install the air cooled remote type condensing unit, the interconnecting refrigerant tubing, and the electrical wiring connections to the unit.

The condensing units are to be used in conjunction with the matching evaporator coils or evaporator blower units for comfort cooling applications as shown in the specification sheet.

These instructions and any instructions packaged with any separate equipment required to make up the entire air conditioning system should be carefully read before beginning the installation. Note particularly "Starting Procedure" and any tags and/or labels attached to the equipment.

While these instructions are intended as a general recommended guide, they do not supersede any national and/or local codes in any way. Authorities having jurisdiction should be consulted before the installation is made.

### SHIPPING DAMAGE

Upon receipt of equipment, the carton should be checked for external signs of shipping damage. If damage is found, the receiving party must contact the last carrier immediately, preferably in writing, requesting inspection by the carrier's agent.

### APPLICATION

Size of unit for a proposed installation should be based on heat loss calculation made according to methods of Air Conditioning Contractors of America. The air duct should be installed in accordance with the Standards of the National Fire Protection Association for the Installation of Air Conditioning and Ventilating Systems of Other Than Residence Type, NFPA No. 90A, and Residence Type Warm Air Heating and Air Conditioning Systems, NFPA 90B. Where local regulations are at a variance with instructions, installer should adhere to local codes.

FIGURE 2

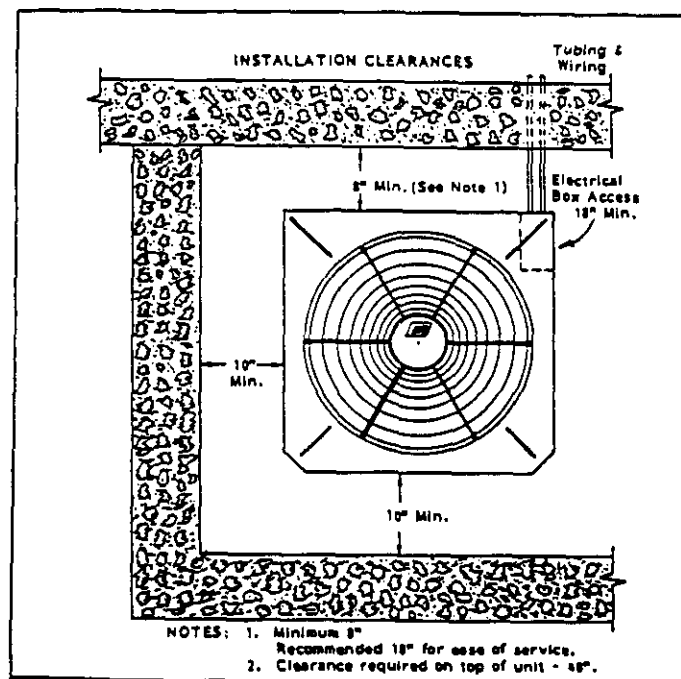



## LOCATION

The condensing unit is designed to be located outside with free and unobstructed condenser air inlet and discharge. It must also permit access for service and installation. Condenser air enters the coil on three sides and discharges upward from the top. Refrigerant and electrical connections are made from the rear of the unit as shown in Figure 2 with electrical service access on the right side. The unit can be installed with the rear of the unit "close to the wall", however, additional service clearance at the back of the unit would be desirable if practical for unit service. The compressor can be serviced through the top.

## MOUNTING UNIT OUTSIDE ON SLAB

A solid level base or platform, capable to support the unit's weight, must be set at the outdoor unit predetermined location. The base should be at least two inches larger than the base dimensions of the unit and at least two inches higher than surrounding grade level. The required unit minimum installed clearances must be maintained as called out in Figure 2 when locating and setting the base.

Remove the unit from its shipping carton and position the unit on the prepared base or platform.

Do not attach the unit or its base to the building structure to avoid the transmission of noise into the occupied area.

**NOTE:** These units employ internally sprung compressors; therefore, it is not necessary to remove or loosen the base mounting bolts on the compressor prior to operation.

Consideration should be given to the electrical and tubing connections when placing the unit to avoid unnecessary bends or length of material.

## INDOOR COIL

These units are designed to match with all indoor blower coils and "A" coils shown earlier in these instructions. All blower and "A" coils shown are produced with an interchangeable brass orifice to provide optimum matching of the refrigerant control when matching alternate sized coils to the outdoor unit. A properly sized orifice for each outdoor section is packaged with this unit. See installation instructions packaged with the coils for complete details.

## IMPORTANT INSTALLER NOTE:

For improved start-up performance, wash the indoor coil with a dishwasher detergent.

## INSTALLING REFRIGERANT TUBING

FIGURE 3

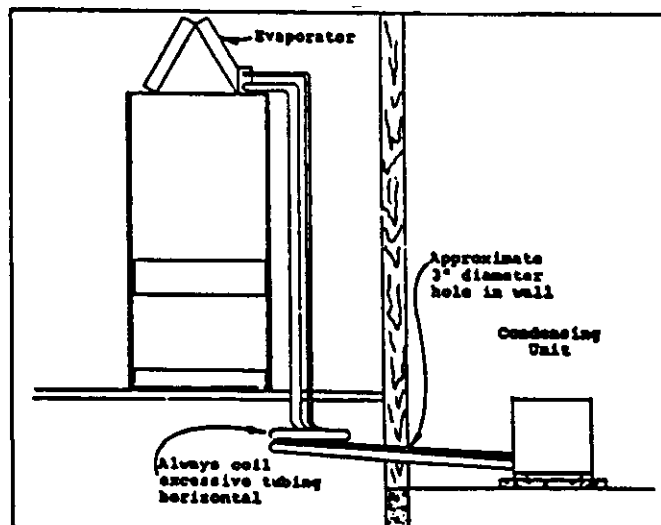

**SWEAT STYLE TUBING CONNECTIONS**

**TABLE 4**

Basic Condensing Unit Model	Refrigerant Line Length (Ft.)		
	0 - 20	21 - 60	61 - 100
	Liquid & Suction	Liquid & Suction	Liquid & Suction
ALL	3/8 & 3/4	3/8 & 7/8	1/2 & 7/8

Use only refrigeration grade (dehydrated and sealed) copper tubing. Care must be taken to insure that the tubing is kept clean and dry before and during installation. Do not remove the plugs from the tubing ends, coil connections or base valves until the connection is ready to be brazed.

The suction line must be insulated with a minimum of 3/8" Armaflex or equivalent before cutting and making connections.

**STEP 1--**Being careful not to kink, route both the suction line and liquid line between the indoor unit and outdoor unit. Use a tubing bender to make any necessary bends in tubing. When necessary to bend the insulated tube suction line, cut the insulation around its circumference at a distance far enough beyond the point of the bend so as to clear the tubing bender. Slip the insulation back together and vapor seal the joint with tape. Coil any excess tubing in a horizontal place with the slope of the tubing toward the condensing unit.

**CAUTION:** 1. Be careful not to tear the insulation when pushing it through holes in masonry or frame walls. 2. When sealing tube opening in house wall, use a soft material to prevent tube damage and vibration transmission. 3. Avoid excessive bending in any one place to avoid kinking.

**STEP 2--**The tubing ends should be cut square. Make sure it is round and free of burrs at the connecting ends. Clean the tubing to prevent contaminants from entering the system.

**STEP 3--**Wrap a wet rag around the copper stub before brazing.

**STEP 4--**Flux the copper tube and insert into the stub. Braze the joint using an alloy of silver or copper and phosphorus with a melting temperature above 1100° F for copper to copper joints. The phosphorus will act as a flux, therefore, no flux will be required.

A copper-silver alloy with a high silver content should be used when iron or steel material is involved in the joint. These alloys require the use of silver solder flux. Alloys containing phosphorus should not be used with iron or steel. Phosphorus reacts with the iron, forming iron phosphate which is extremely brittle.

**CAUTION:** 1. Brazing alloys with a melting temperature below 700 degrees F should not be used. 2. Lead-tin or tin-antimony solders should not be used due to their low melting point and necessity for corrosive fluxes.

To further prevent the formation of copper oxide inside the tubing, dry nitrogen may be purged through the refrigerant system during brazing.

\*\*\*\*\*

**WARNING:** Never purge or pressurize a system with oxygen. An explosion and fire will result.

\*\*\*\*\*

**STEP 5--**After brazing, quench with wet rag to cool the joint and remove any flux residue.

**STEP 6--**Leak test all connections using an electronic leak detector or a halide torch.

## II. WIRING INSTRUCTIONS

### GENERAL

All wiring must be installed in accordance with the National Electrical Code and local codes. In Canada, all wiring must be installed in accordance with the Canadian Electrical Code and in accordance with the regulations of the authorities having jurisdiction. Power supply voltage must conform to the voltage shown on the unit serial plate. A wiring diagram of the unit is attached to the inside of the electrical cover. The power supply shall be sized and fused according to the specifications supplied. A ground lug is supplied in the control compartment for equipment ground.

The control circuit is a 24 volt circuit. "Typical" wiring diagrams illustrating some of the various circuits which could be encountered can be found in the installation instructions of the indoor section.

The unit rating plate lists a "Maximum Time Delay Fuse" or "BACR Type" circuit breaker that is to be used with the equipment. The correct size must be used for proper circuit protection and also to assure that there will be no nuisance tripping due to the momentary high starting current of the compressor motor.

### DISCHARGE TEMPERATURE SENSOR (2412 - 4212 Models)

Each scroll compressor is equipped with discharge temperature sensor located on the outside top of the compressor. The sensor is a SPST thermostat which opens when the discharge temperature exceeds  $280^{\circ}\text{F} + 8^{\circ}\text{F}$  on a temperature rise. When the switch opens, the circuit to the compressor contactor is de-energized and the unit shuts off. The switch automatically resets when the compressor temperature drops below  $130^{\circ}\text{F} + 14^{\circ}\text{F}$ .

The sensor can be accessed by prying on the snap plug on top of the compressor (See Figure 4). Make sure to securely reseal the sensor after replacement. The sensor terminals are located inside the compressor terminal box. Figure 5 shows the arrangement of compressor line voltage terminals and discharge sensor terminals.

FIGURE 4

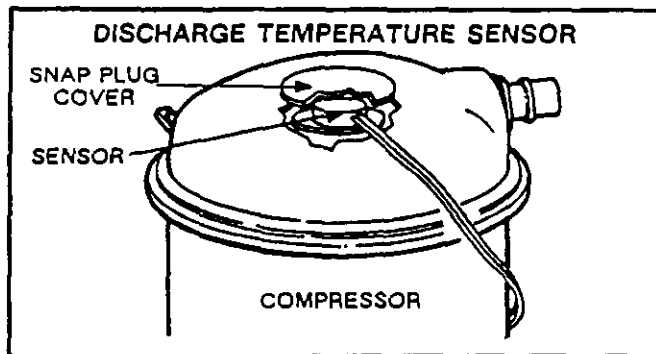
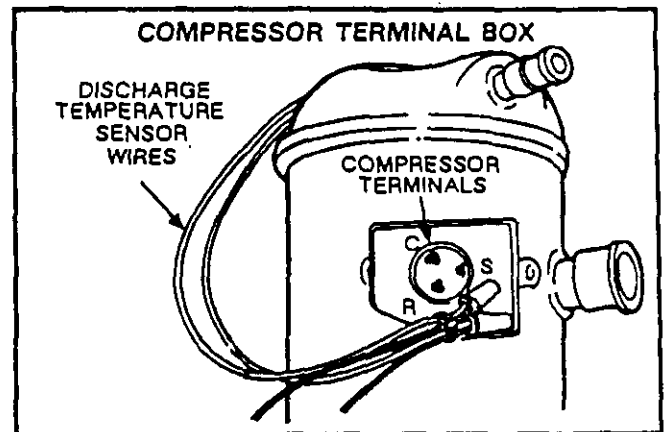

FIGURE 5



## WALL THERMOSTATS

The following wall thermostats and subbases should be used as indicated, depending on the application.

TABLE 5

AIR CONDITIONING THERMOSTATS		
Part No.	Model No.	Description
8403-002	T87F3111	THERMOSTAT--1 stg. heat, adj. heater, Mercury
8404-003	Q539A1220	SUBBASE --System Heat-Off-Cool Fan: On-Auto
8403-008	ID51-605	THERMOSTAT--1 stg. cool, System w/Off Sw. Snap Action Fan: Auto-On
8403-009	IF56-318	THERMOSTAT--1 st. cool, 1 stg. heat, Adj. heater Mercury System: Heat-Off-Cool Fan: Auto-On
8403-019	T874C1000	THERMOSTAT--1 stg. cool, 2 stg. heat, Adj. heater, Mercury
8404-012	Q674A1001	SUBBASE --System: Heat-Auto-Cool Fan: Auto-On

### III. CHARGING INSTRUCTIONS

#### PRESSURE SERVICE PORTS

High and low pressure service ports are installed on all units so that the system operating pressures can be observed. Pressure tables can be found later in the manual covering all models. It is imperative to match the correct pressure table to the unit by model number.

#### SYSTEM START-UP

The outdoor section of the air conditioner units are shipped with a factory R-22 charge sufficient for the nominal (size for size) matching "A" coil when used with 25' of interconnecting tubing. The units are shipped with the base valves in the closed position to contain the refrigerant charge within the unit.

1. For "S" models, connect a vacuum pump to both base valve service ports.
2. Evacuate the tubing and evaporator to 500 microns or less for a minimum of 30 minutes. Close the valve to the pump and wait for 15 minutes. The vacuum should not rise above 800 microns. If it rises above 800 or if you are not able to obtain 500 micron vacuum, pressurize with R-22, leak check, repair any leaks and repeat step 2.
3. Close valve to the vacuum pump and disconnect. Break the vacuum by opening both the suction and liquid line base valves to the fully open position and connect service gauges for pressure check.
4. Close disconnect switch and set the thermostat to cool and the temperature to the highest setting.
5. Check for proper operation of the indoor fan and outdoor unit.
6. Check and adjust charge if necessary. Refer to charge checking section.

## REFRIGERANT CHARGE CHECKING

1. After connecting the service gauges and allowing the unit to run for at least 10 minutes until pressures are stable, record the suction and discharge (liquid) pressure.
2. Install a thermometer on the suction line approximately 6" to 10" from the compressor on all models.
3. Determine superheat.

Refer to Table 6 to determine the saturated suction temperature.

Suction line temperature (from step 2) \_\_\_\_\_

Minus saturated suction temperature - \_\_\_\_\_

Equals--superheat \_\_\_\_\_

4. Measure outdoor temperature and return air dry bulb and wet bulb temperature and refer to Table 7 to determine the proper superheat setting.
5. Adjust the charge to the proper superheat by adding charge to lower and removing charge to raise the superheat.
6. Check final system operating pressures by comparing to the pressure tables later in this manual.

TABLE 6

SATURATED SUCTION TEMPERATURE (R-22)	
Suction Pressure PSIG	Saturated Suction Temperature (Deg. F)
50	26
53	28
55	30
58	32
61	34
63	36
65	38
67	39
70	41
73	43
76	45
79	47
82	49
86	51

TABLE 7

SYSTEM SUPERHEAT				
Outdoor Ambient Temperature (Deg. F Dry Bulb)	Return Air Temperature Deg. F--Wet Bulb			
	59	63	67	71
105	1	1	5	
95	1	3	(8)	20
90	1	7	14	26
85	3	9	19	33
80	8	14	25	39
75	10	20	30	42

TABLE 8

TOTAL SYSTEM OPERATING CHARGE (Includes charge for the basic outdoor unit, indoor coil and 25' of interconnecting tubing)		
Outdoor Section	Indoor Section	Total R-22 Charge (Oz.)
2412UACSA	A36AS-A	107 oz.
	BC24B	116 oz.
3012UACSA	A36AS-A	100 oz.
	BC30B	102 oz.
	BC36B	110 oz.
3612UACSA	A36AS-A	162 oz.
	A37AS-A	173 oz.
	BC36B	172 oz.
4212UACSA	A48AS-A	213 oz.
	BC36B	197 oz.
4812UACSA	A61AS-A	221 oz.
	BC48B	211 oz.
	BC60B	240 oz.
6012UACSA,QA	A61AS-A,AQ-A	215 oz.
	BC60B	230 oz.

The above includes 25' of 3/8" diameter liquid line. For other than 25' and other tube sizes, adjust the total charge according to the following schedule.

<u>Liquid Line Diameter</u>	<u>Oz, R-22 Per Ft.</u>
3/8"	.6
1/2"	1.2

**INSTALLER NOTE:** Stamp or mark the final system charge determined above on the outdoor unit serial plate.

**Examples:** 3612UACSA and A36AS-A with 35' liquid line  
 $35' - 25' = 10' \times .6 = 6 \text{ oz.}$        $162 + 6 = 168 \text{ oz. Total}$

3612UACSA and A36AS-A with 18' liquid line  
 $25' - 18' = 7' \times .6 = 4.2 \text{ oz.}$        $162 - 4 = 158 \text{ oz. Total}$

**NOTE:** Round all decimals to nearest whole number.

## IV. SERVICE

### SERVICE HINTS

1. Caution homeowner to maintain clean air filters at all times. Also, not to needlessly close off supply and return air registers. This reduces air flow through the system, which shortens equipment service life as well as increasing operating costs.
2. Check all power fuses or circuit breakers to be sure that they are the correct rating.
3. Periodic cleaning of the outdoor coil to permit full and unrestricted air flow circulation is essential.

### FAN BLADE SETTING DIMENSIONS

Shown in the drawing below are the correct fan blade setting dimensions for proper air delivery across the outdoor coil.

Any service work requiring removal or adjustment in the and/or motor area will require that the dimensions below be checked and blade adjusted in or out on the motor shaft accordingly.

FIGURE 6

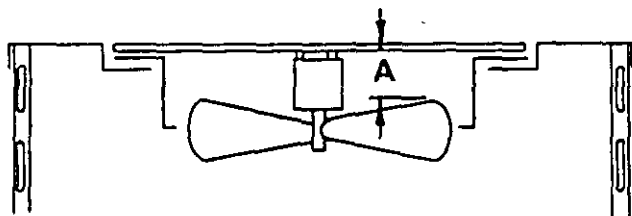
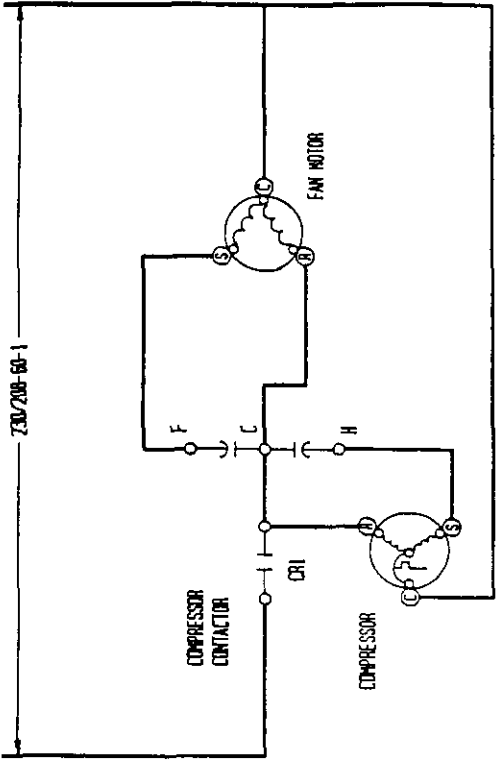
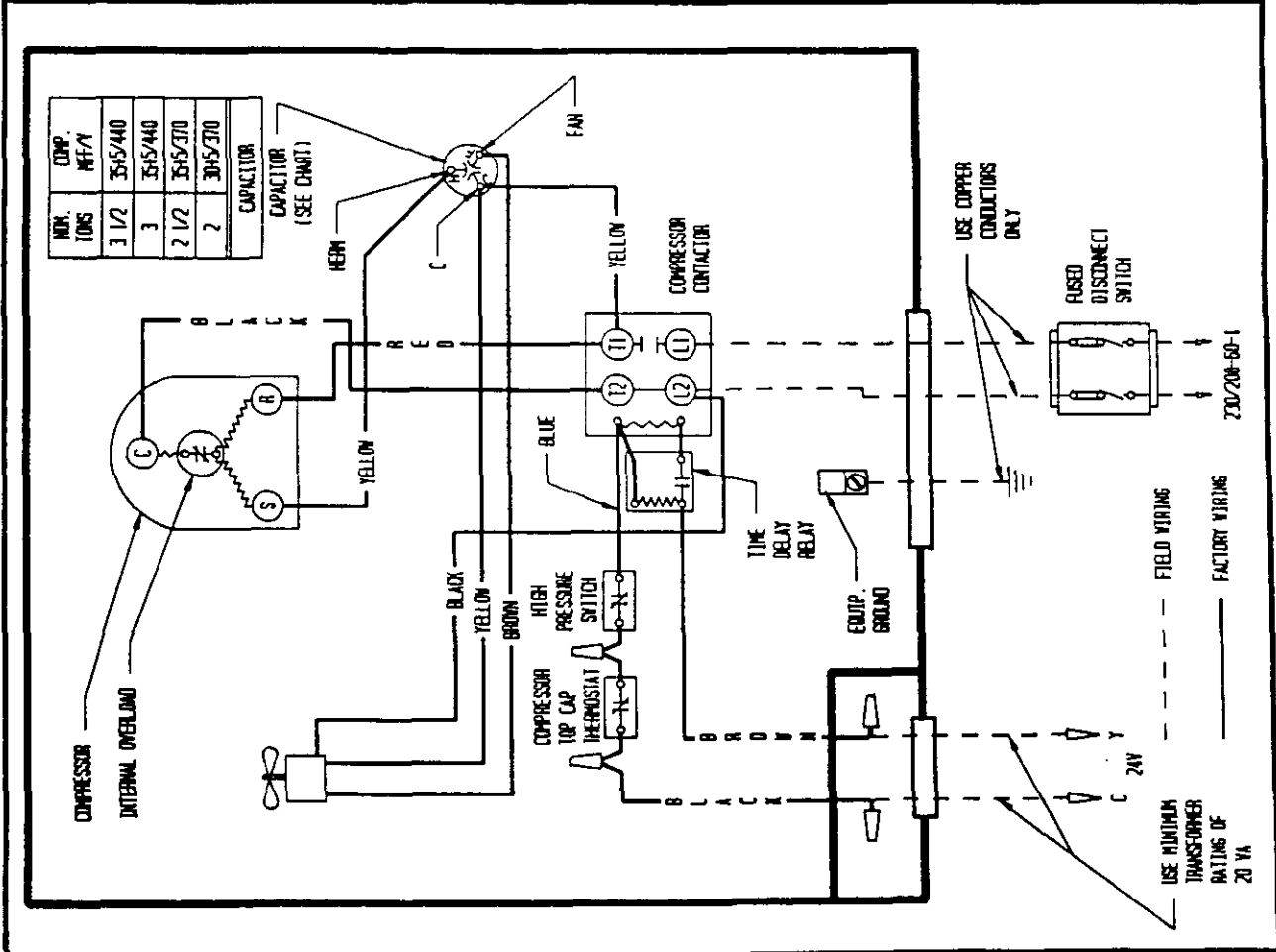

TABLE 9

Model	Dimension A
2412UASA 3012UACSA 3612UACSA	3-1/2
4212UACSA 4812UACSA 6012UACSA, QA	4

### UNBRAZING SYSTEM COMPONENTS

If the refrigerant charge is removed from a scroll equipped unit by bleeding the high side only, it is sometimes possible for the scrolls to seal, preventing pressure equalization through the compressor. This may leave low side shell and suction line tubing pressurized. If the brazing torch is then applied to the low side while the low side shell and suction line contains pressure, the pressurized refrigerant and oil mixture could ignite when it escapes and contacts the brazing flame. To prevent this occurrence, it is important to check both the high and low side with manifold gauges before unbrazing.



HIGH VOLTAGE CIRCUIT

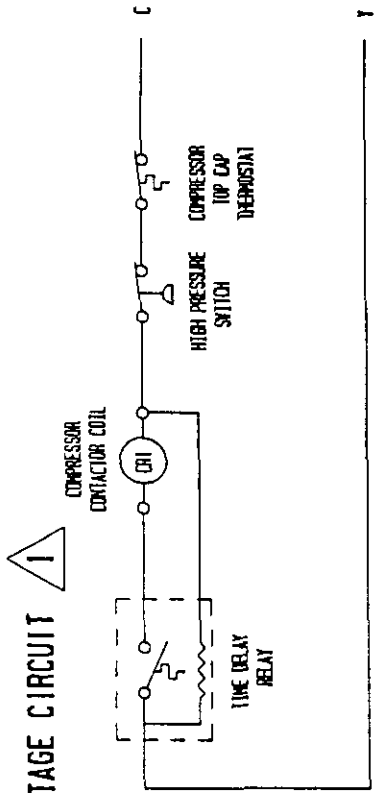

LOW VOLTAGE CIRCUIT

⚠ 24 VOLTS FOR LOW VOLTAGE CONTROL CIRCUIT SUPPLIED BY INDOOR UNIT TRANSFORMER



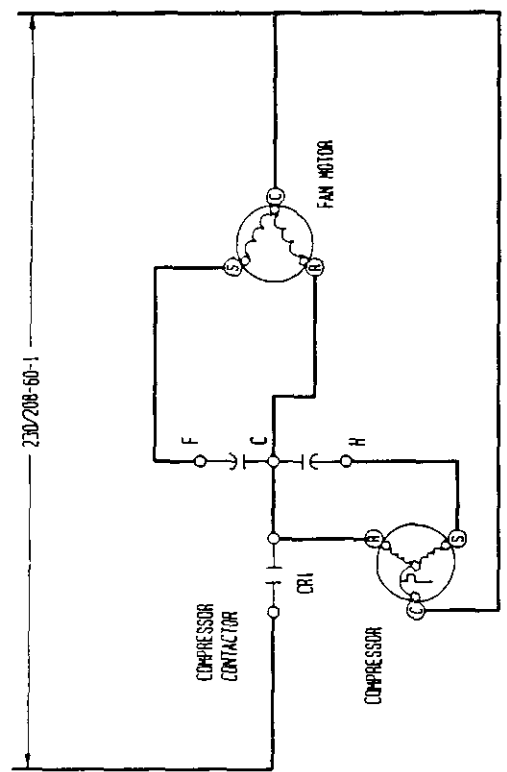
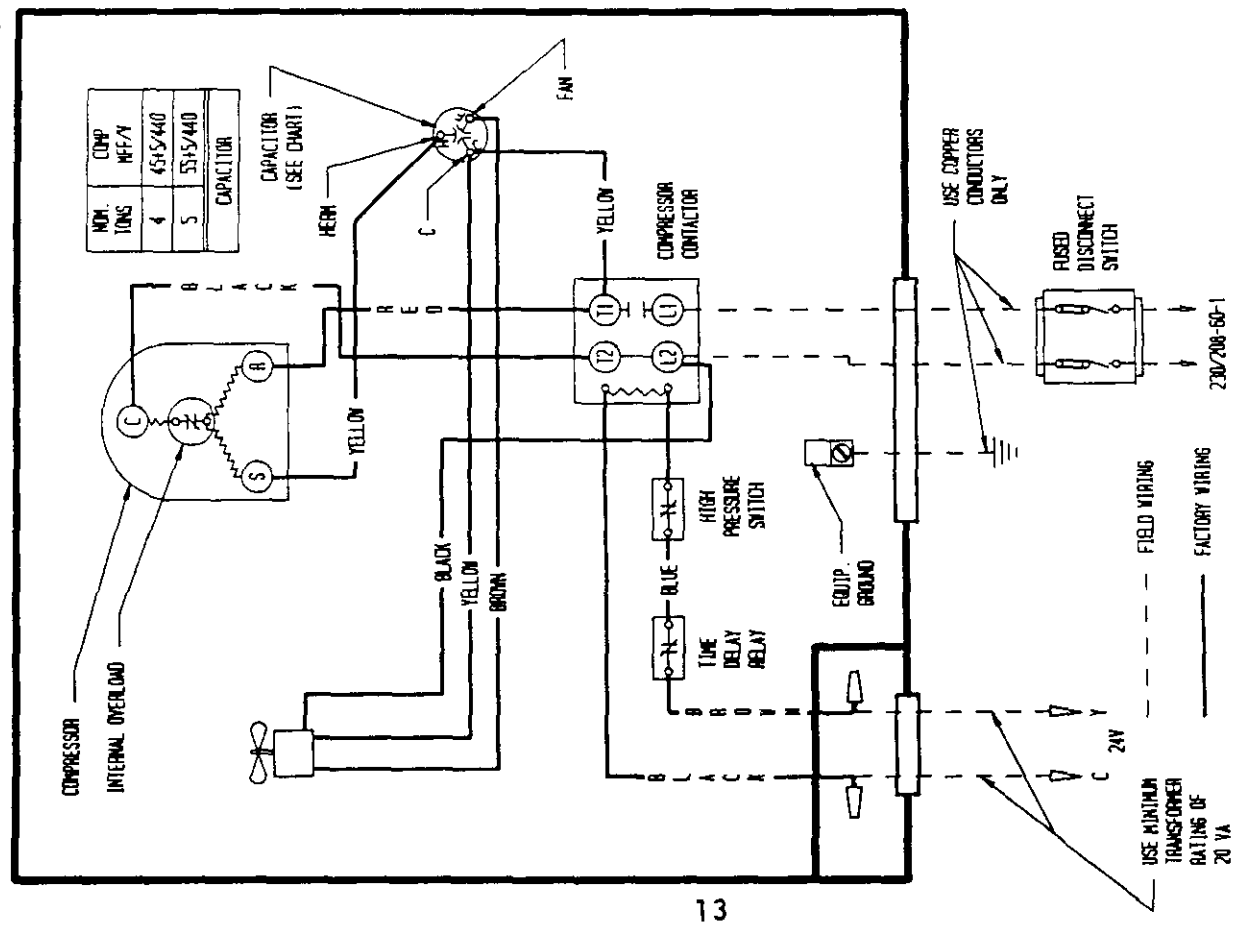

HIGH VOLTAGE CIRCUIT

LOW VOLTAGE CIRCUIT

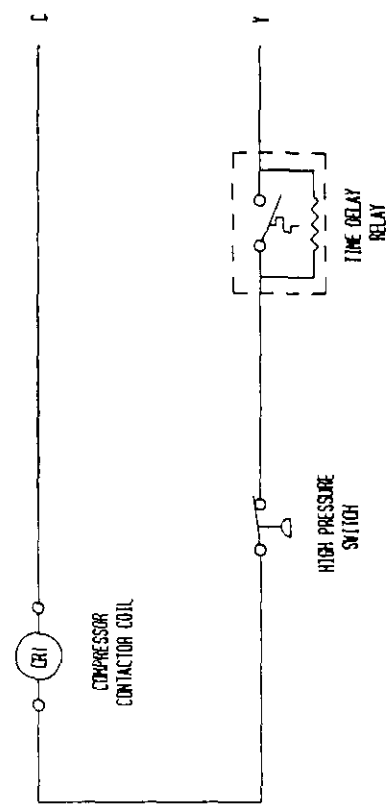

▲ 24 VOLTS FOR LOW VOLTAGE CONTROL CIRCUIT SUPPLIED BY INDOOR UNIT TRANSFORMER

COOLING			Air Temperature Entering Outdoor Coil Degree F								
Model	Return Air Temperature	Pressure	°	°	°	°	°	°	°	°	°
			75	80	85	90	95	100	105	110	115
A36AS-A Rated CFM 820	75 deg. DB	Low Side	68	71	73	75	77	78	79	80	80
	62 deg. WB	High Side	165	179	194	209	224	240	256	273	291
	80 deg. DB	Low Side	74	76	78	80	82	83	85	85	86
	67 deg. WB	High Side	170	184	199	214	230	246	263	281	299
	85 deg. DB	Low Side	80	82	84	86	88	89	91	91	92
	72 deg. WB	High Side	177	191	206	222	238	255	272	290	309
	75 deg. DB	Low Side	72	73	75	76	77	78	79	80	81
	62 deg. WB	High Side	172	186	201	215	230	245	260	276	292
BC24B Rated CFM 775	80 deg. DB	Low Side	78	79	81	82	83	84	85	86	87
	67 deg. WB	High Side	177	191	206	221	236	252	267	284	300
	85 deg. DB	Low Side	84	85	87	88	89	90	91	92	93
	72 deg. WB	High Side	183	198	213	228	244	260	276	293	310

COOLING			Air Temperature Entering Outdoor Coil Degree F								
Model	Return Air Temperature	Pressure	°	°	°	°	°	°	°	°	°
			75	80	85	90	95	100	105	110	115
A36AS-A Rated CFM 1050	75 deg. DB	Low Side	70	71	73	74	75	76	77	78	79
	62 deg. WB	High Side	172	183	196	209	224	240	257	276	296
	80 deg. DB	Low Side	74	76	78	80	81	82	83	84	85
	67 deg. WB	High Side	177	188	201	215	230	247	264	284	304
	85 deg. DB	Low Side	80	82	84	86	87	88	89	90	91
	72 deg. WB	High Side	182	194	207	222	238	255	274	294	315
	75 deg. DB	Low Side	66	68	69	70	71	72	73	74	75
	62 deg. WB	High Side	167	182	197	213	229	245	262	278	295
BC30B Rated CFM 800	80 deg. DB	Low Side	71	76	74	75	76	77	78	79	80
	67 deg. WB	High Side	171	187	203	219	235	252	268	286	303
	85 deg. DB	Low Side	76	78	79	80	81	82	83	85	86
	72 deg. WB	High Side	176	192	209	226	243	260	278	295	313
BC36B Rated CFM 1050	75 deg. DB	Low Side	72	73	75	76	77	78	79	79	80
	62 deg. WB	High Side	166	181	196	211	227	243	259	275	292
	80 deg. DB	Low Side	76	78	80	82	83	84	85	86	86
	67 deg. WB	High Side	171	186	201	217	233	249	266	283	300
	85 deg. DB	Low Side	82	84	86	88	89	90	91	92	92
	72 deg. WB	High Side	177	193	208	225	241	258	275	292	310

Low side pressure  $\pm$  2 PSIG (suction line @ outdoor unit base valve)

High side pressure  $\pm$  5 PSIG (liquid line @ outdoor unit base valve)

Tables are based upon rated CFM (airflow) across the evaporator coil and should be found under section titled "Refrigerant Charge" elsewhere in manual. If there is any doubt as to correct operating charge being in the system, the charge should be removed, system evacuated, and recharged to serial plate instructions.

COOLING			Air Temperature Entering Outdoor Coil Degree F								
Model	Return Air Temperature	Pressure	75°	80°	85°	90°	95°	100°	105°	110°	115°
A36AS-A Rated CFM 1200	75 deg. DB	Low Side	66	68	70	72	73	74	75	76	77
	62 deg. WB	High Side	168	183	198	214	231	248	266	284	302
	80 deg. DB	Low Side	71	73	75	77	78	79	80	81	82
	67 deg. WB	High Side	172	188	204	220	237	254	272	291	310
A37AS-A Rated CFM 1200	85 deg. DB	Low Side	76	78	80	82	84	85	87	87	88
	72 deg. WB	High Side	177	193	210	227	245	263	282	301	320
	75 deg. DB	Low Side	69	71	73	75	77	79	80	81	82
	62 deg. WB	High Side	173	189	205	221	238	255	272	290	308
BC36B Rated CFM 1200	80 deg. DB	Low Side	74	76	78	80	82	84	85	87	88
	67 deg. WB	High Side	177	193	210	227	244	262	279	298	316
	85 deg. DB	Low Side	80	82	84	86	88	90	92	93	95
	72 deg. WB	High Side	184	200	217	234	252	270	289	308	327
BC36B Rated CFM 1200	75 deg. DB	Low Side	66	67	69	70	72	74	75	77	78
	62 deg. WB	High Side	168	184	199	215	230	245	261	276	292
	80 deg. DB	Low Side	71	72	74	75	77	79	80	82	83
	67 deg. WB	High Side	173	189	204	220	236	252	268	283	299
BC36B Rated CFM 1200	85 deg. DB	Low Side	76	77	79	80	82	84	85	87	88
	72 deg. WB	High Side	178	194	211	227	244	261	277	294	310

COOLING			Air Temperature Entering Outdoor Coil Degree F								
Model	Return Air Temperature	Pressure	75°	80°	85°	90°	95°	100°	105°	110°	115°
A48AS-A Rated CFM 1325	75 deg. DB	Low Side	65	67	69	71	73	75	76	78	79
	62 deg. WB	High Side	159	174	189	205	221	237	254	271	289
	80 deg. DB	Low Side	70	72	74	76	78	80	82	83	85
	67 deg. WB	High Side	163	179	194	211	227	244	261	278	296
BC36B Rated CFM 1240	85 deg. DB	Low Side	74	77	79	82	84	86	88	90	91
	72 deg. WB	High Side	168	184	201	218	235	252	270	288	306
	75 deg. DB	Low Side	61	64	66	68	70	71	72	73	73
	62 deg. WB	High Side	156	170	185	200	216	232	249	266	283
BC36B Rated CFM 1240	80 deg. DB	Low Side	66	69	71	73	75	76	77	78	78
	67 deg. WB	High Side	160	175	190	206	222	239	256	273	291
	85 deg. DB	Low Side	70	74	77	79	81	82	83	84	84
	72 deg. WB	High Side	165	181	197	213	230	247	265	283	301

Low side pressure + 2 PSIG (suction line @ outdoor unit base valve)

High side pressure + 5 PSIG (liquid line @ outdoor unit base valve)

Tables are based upon rated CFM (airflow) across the evaporator coil and should be found under section titled "Refrigerant Charge" elsewhere in manual. If there is any doubt as to correct operating charge being in the system, the charge should be removed, system evacuated, and recharged to serial plate instructions.

COOLING			Air Temperature Entering Outdoor Coil Degree F								
Model	Return Air Temperature	Pressure	°	°	°	°	°	°	°	°	°
			75	80	85	90	95	100	105	110	115
A61AS-A Rated CFM 1600	75 deg. DB	Low Side	70	72	74	76	77	78	79	79	79
	62 deg. WB	High Side	170	183	197	212	228	245	264	284	305
	80 deg. DB	Low Side	75	77	79	81	82	83	84	85	85
	67 deg. WB	High Side	174	187	202	217	234	252	271	291	313
BC48B Rated CFM 1600	85 deg. DB	Low Side	81	83	85	87	88	89	90	91	91
	72 deg. WB	High Side	179	193	208	225	242	261	281	302	324
	75 deg. DB	Low Side	63	66	69	71	73	75	76	77	78
	62 deg. WB	High Side	168	180	193	208	224	241	260	280	302
BC60B Rated CFM 1600	80 deg. DB	Low Side	68	71	74	76	78	80	81	82	83
	67 deg. WB	High Side	172	185	198	213	230	248	267	288	310
	85 deg. DB	Low Side	72	76	79	82	84	86	87	88	89
	72 deg. WB	High Side	177	190	205	221	238	257	276	298	320
BC60B Rated CFM 1600	75 deg. DB	Low Side	69	72	74	76	78	79	80	81	81
	62 deg. WB	High Side	170	184	199	214	230	246	263	281	299
	80 deg. DB	Low Side	75	77	79	81	83	84	86	86	87
	67 deg. WB	High Side	175	189	204	220	236	253	270	288	307
BC60B Rated CFM 1600	85 deg. DB	Low Side	81	83	85	87	89	90	92	92	93
	72 deg. WB	High Side	179	195	211	227	244	261	279	298	307

COOLING			Air Temperature Entering Outdoor Coil Degree F								
Model	Return Air Temperature	Pressure	°	°	°	°	°	°	°	°	°
			75	80	85	90	95	100	105	110	115
A61AQ-A A61AS-A Rated CFM 1725	75 deg. DB	Low Side	68	70	71	72	73	74	75	77	78
	62 deg. WB	High Side	175	191	208	225	241	257	274	290	306
	80 deg. DB	Low Side	73	75	76	77	78	79	80	82	83
	67 deg. WB	High Side	179	196	213	230	247	264	281	297	314
BC60B Rated CFM 1800	85 deg. DB	Low Side	79	81	82	83	84	85	86	88	89
	72 deg. WB	High Side	186	203	220	238	255	272	290	307	324
	75 deg. DB	Low Side	68	70	72	74	75	76	77	78	78
	62 deg. WB	High Side	177	192	207	223	240	257	275	293	312
BC60B Rated CFM 1800	80 deg. DB	Low Side	73	75	77	79	80	81	82	83	84
	67 deg. WB	High Side	182	197	213	229	246	264	282	301	320
	85 deg. DB	Low Side	79	81	83	85	86	87	88	89	90
	72 deg. WB	High Side	187	203	220	237	255	273	292	311	331

Low side pressure  $\pm$  2 PSIG (suction line @ outdoor unit base valve)

High side pressure  $\pm$  5 PSIG (liquid line @ outdoor unit base valve)

Tables are based upon rated CFM (airflow) across the evaporator coil and should be found under section titled "Refrigerant Charge" elsewhere in manual. If there is any doubt as to correct operating charge being in the system, the charge should be removed, system evacuated, and recharged to serial plate instructions.