

INSTALLATION INSTRUCTIONS

SPLIT AIR CONDITIONER OUTDOOR SECTION

MODELS

2412UACSB

3012UACSB

3612UACSB

4212UACSB

4812UACSB

6012UACSB

**FOR USE WITH:
MATCHING INDOOR BLOWER
COIL UNITS AND MATCHING
ADD ON COIL UNITS ONLY**

MANUAL: 2100-169 REV.K
SUPERSEDES: REV. J
FILE: Vol. I, Tab 4
DATE: 07/10/96

TABLE OF CONTENTS

I. Application and Location 4
General 4
Shipping Damage 4
Application 4
Location 5
Mounting Unit Outside on Slab 5
Important Installer Note 5
Installing Refrigerant Tubing 5
Sweat Style Tubing Connections: Sweat Indoor Unit & Sweat Outdoor Unit. 6
Field Fabricated Tubing Connections: Quick Connect Indoor Unit & Sweat. 8
Outdoor Unit Using CTO Kit

II. Wiring Instructions 10
General 10
Control Circuit Wiring 10
Discharge Temperature Sensor (2412- 4212 Models) 14
Wall Thermostats 14

III. Charging Instructions 14
Pressure Service Ports 14
System Start-Up (Non-TXV Indoor Units). 15
System Start-Up (TXV Indoor Units). 16

IV. Service 18
Service Hints 18
Fan Blade Setting Dimensions 18
Unbrazing System Components 18
Wiring Diagrams 19-20
Pressure Tables 22-24

FIGURES AND TABLES

Figure 1	1
Figure 2	4
Figure 3	5
Figure 4	6
Figure 5	14
Figure 6	14

Table 1	1
Table 2	2
Table 3	3
Table 3A	7
Table 4	10
Table 5	11
Table 6	11
Table 7	14
Table 8	15
Table 9	15
Table 10	16
Table 11	16
Table 12	17
Table 13	18
Table 14	22
Table 15	22
Table 16	23
Table 17	23
Table 18	24
Table 19	24

FIGURE 1

NOMENCLATURE EXPLANATION - Example:

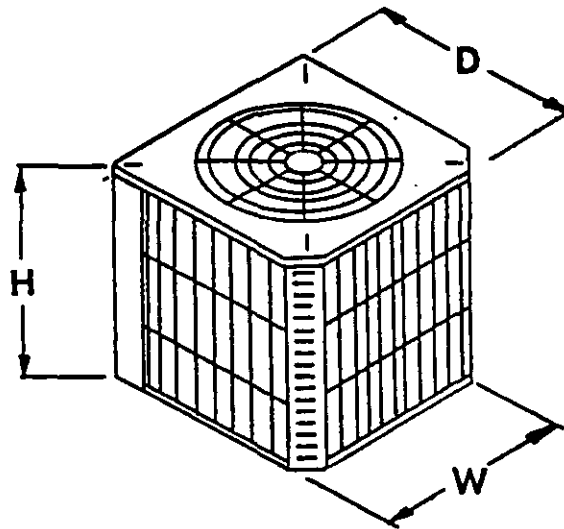
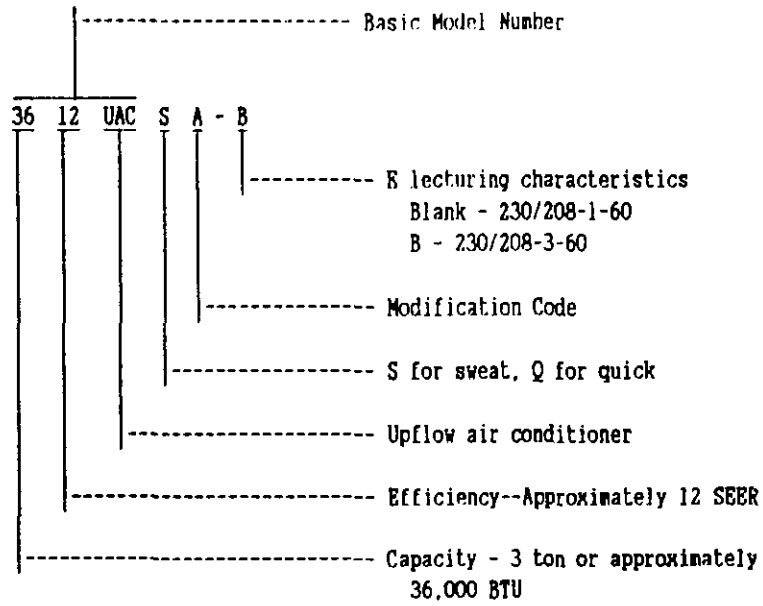

TABLE 1

Basic Model No.	DIMENSIONS		
	"W" Width	"D" Depth	"H" Height
2412UACSB 3012UACSB 3612UACSB	32-1/2	32-1/2	26"
4212UACSB 4812UACSB 6012UACSB	32-1/2	32-1/2	36"

TABLE 2 RATED CFM AND AIR FLOW DATA (WET COIL--COOLING)

Condensing Unit Model Number	Evaporator Coil Model Number	Rated Airflow		Rated E.S.P. (2)	Motor Speed Tap	Recommended Air Flow Range	System Orifice Required
		CFM	Pressure Drop H ₂ O (1)				
2412UACSB	A36AS-A	820	.15	.15	High	700 - 910	.061*
	BC24B	775				680 - 890	.059
3012UACSB	A36AS-A	1050	.20	.10 .21	High Low	900 - 1325	.067
	BC30B	800				700 - 910	.063
	BC36B	1050				900 - 1325	.067*
3612UACSB	A36AS-A	1200	.30	.20	High	1020 - 1320	.072*
	A37AS-A	1200	.25			1020 - 1320	.072
	BC36B	1200				1020 - 1320	.072
4212UACSB	A48AS-A	1325	.20	.15	High	1125 - 1450	.081
	BC36B	1240				1060 - 1360	.081*
4812UACSB	A61XS-A	1600	.25	.38	Low	1360 - 1760	TKV
	BC60BX	1600				1360 - 1760	TKV
6012UACSB	A61XS-A	1780	.30	.30	High	1500 - 1950	TKV
	BC60BX	1800				1525 - 1975	TKV

(1) Measured across the evaporator coil assembly, including drain pan.

(2) External static pressure available for the duct system - supply and return. All blower coils have multi-speed motors, and value shown is at the recommended rated speed. Consult specification air flow charts with the blower coil units for complete information at other speeds.

***IMPORTANT**

Proper sized orifice is not factory installed in indoor section. Proper orifice size is shipped with outdoor unit packaged with its installation instructions for indoor sections listed on this page. The orifice must be replaced with the proper system orifice shown above in Table 2.

For other evaporator coil models not listed, see indoor coil installation instructions for proper orifice information.

TABLE 3

SPECIFICATIONS--SPLIT AIR CONDITIONING

MODEL	2412UACSB	3012UACSB	3612UACSB	4212UACSB	4812UACSB	6012UACSB
ELECTRICAL RATING (60Hz/V/Ph)	230/208-1	230/208-1	230/208-1	230/208-1	230/208-1	230/208-1
Operating Voltage Range	197-253	197-253	197-253	197-253	197-253	197-253
Minimum Circuit Ampacity	14	18	22	24	31	38
*Field Wire Size	#14	#12	#10	#10	#8	#8
**Delay Fuse Max. or Ckt. Bkr.	20	30	35	40	50	60
Total Unit Amps 230/208	9.1/10.1	11.6/12.1	14.1/14.6	18.5/17.5	17.8/20.3	23.3/25.8
COMPRESSOR						
Volts	230/208	230/208	230/208	230/208	230/208	230/208
Rated Load Amps 230/208	8/9	10.5/11	13/13.5	17/16	16.5/19	22/24.5
Branch Circuit Selection Current	10.3	13.5	16	17.9	23.7	28.8
Lock Rotor Amps 230/208	56/56	72.5/72.5	88/88	104/104	129/129	169/169
FAN MOTOR & CONDENSER						
Fan Motor--HP/RPM	1/6 - 825	1/6 - 825	1/6 - 825	1/4 - 825	1/3 - 1075	1/3 - 1075
Fan Motor--AMPS	1.1	1.1	1.1	1.5	1.3	1.3
Fan--DIA/CFM	24" - 3000	24" - 3000	24" - 3000	24" - 3100	24" - 3100	24" - 3100
REFRIGERANT CONNECTION AND CHG.						
Suction Line Size	7/8"	7/8"	7/8"	7/8"	7/8"	7/8"
Liquid Line Size	3/8"	3/8"	3/8"	3/8"	3/8"	3/8"
*60 degree C Copper wire size.						
**Maximum time delay fuse or HACR Type circuit breaker.						

I. APPLICATION AND LOCATION

GENERAL

These instructions explain the recommended method to install the air cooled remote type condensing unit, the interconnecting refrigerant tubing, and the electrical wiring connections to the unit.

The condensing units are to be used in conjunction with the matching evaporator coils or evaporator blower units for comfort cooling applications as shown in the specification sheet.

These instructions and any instructions packaged with any separate equipment required to make up the entire air conditioning system should be carefully read before beginning the installation. Note particularly "Starting Procedure" and any tags and/or labels attached to the equipment.

While these instructions are intended as a general recommended guide, they do not supersede any national and/or local codes in any way. Authorities having jurisdiction should be consulted before the installation is made.

SHIPPING DAMAGE

Upon receipt of equipment, the carton should be checked for external signs of shipping damage. If damage is found, the receiving party must contact the last carrier immediately, preferably in writing, requesting inspection by the carrier's agent.

APPLICATION

Size of unit for a proposed installation should be based on heat loss calculation made according to methods of Air Conditioning Contractors of America. The air duct should be installed in accordance with the Standards of the National Fire Protection Association for the Installation of Air Conditioning and Ventilating Systems of Other Than Residence Type, NFPA No. 90A, and Residence Type Warm Air Heating and Air Conditioning Systems, NFPA 90B. Where local regulations are at a variance with instructions, installer should adhere to local codes.

FIGURE 2

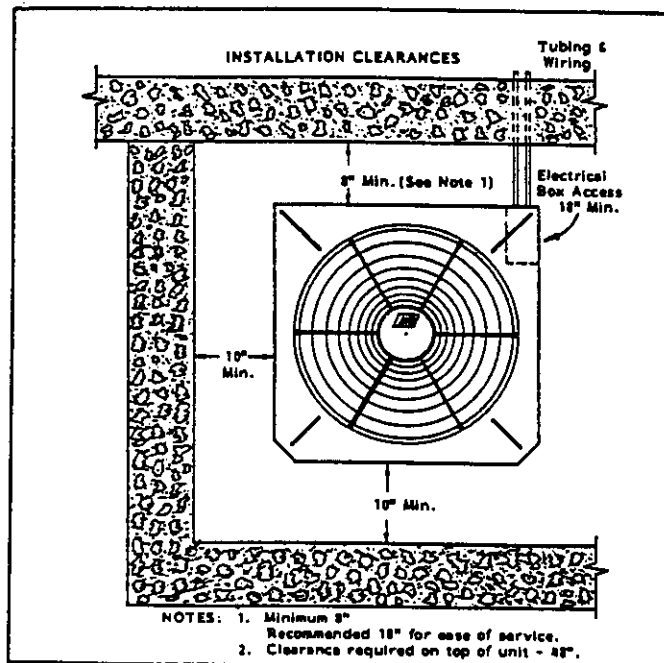

LOCATION

The condensing unit is designed to be located outside with free and unobstructed condenser air inlet and discharge. It must also permit access for service and installation. Condenser air enters the coil on three sides and discharges upward from the top. Refrigerant and electrical connections are made from the rear of the unit as shown in Figure 2 with electrical service access on the right side. The unit can be installed with the rear of the unit "close to the wall", however, additional service clearance at the back of the unit would be desirable if practical for unit service. The compressor can be serviced through the top.

MOUNTING UNIT OUTSIDE ON SLAB

A solid level base or platform, capable to support the unit's weight, must be set at the outdoor unit predetermined location. The base should be at least two inches larger than the base dimensions of the unit and at least two inches higher than surrounding grade level. The required unit minimum installed clearances must be maintained as called out in Figure 2 when locating and setting the base.

Remove the unit from its shipping carton and position the unit on the prepared base or platform.

Do not attach the unit or its base to the building structure to avoid the transmission of noise into the occupied area.

NOTE: These units employ internally sprung compressors; therefore, it is not necessary to remove or loosen the base mounting bolts on the compressor prior to operation.

Consideration should be given to the electrical and tubing connections when placing the unit to avoid unnecessary bends or length of material.

IMPORTANT INSTALLER NOTE:

For improved start-up performance, wash the indoor coil with a dishwasher detergent.

INSTALLING REFRIGERANT TUBING

The information that follows on installing refrigerant tubing and for changing the system orifice (if required) covers applications listed in the front of this installation instruction only. Although other indoor units may be of similar construction, the installation instructions for these units should be consulted for proper installation of those units prior to installation.

This information is provided for the field service personnel to install refrigerant tubing in compliance with Section 608 of Title VI National Recycling and Emission Reduction Program for the U.S. Clean Air Act effective July 1, 1992.

Consult manual 2100-002 on procedure for leak test--evacuation--charging before installation refrigerant tubing that requires any refrigerant recovery or system evacuation. Manual 2100-002 is included with the unit installation instruction package when shipped from the factory.

FIGURE 3

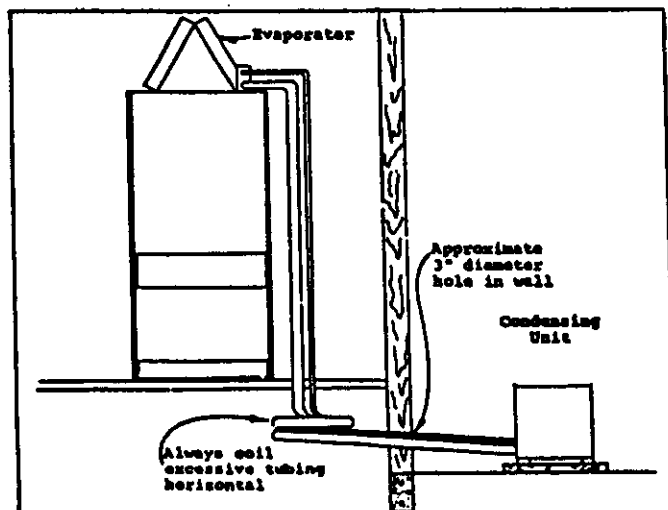

SWEAT STYLE TUBING CONNECTIONS: SWEAT INDOOR UNIT AND SWEAT OUTDOOR UNIT

Use only refrigeration grade (dehydrated and sealed) copper tubing. Care must be taken to insure that the tubing is kept clean and dry before and during installation. Do not remove the plugs from the tubing ends, coil connections or base valves until the connection is ready to be brazed.

The suction line must be insulated with a minimum of 3/8" Armaflex or equivalent before cutting and making connections.

STEP 1--Being careful not to kink, route both the suction line and liquid line between the indoor unit and outdoor unit. Use a tubing bender to make any necessary bends in tubing. When necessary to bend the insulated tube suction line, cut the insulation around its circumference at a distance far enough beyond the point of the bend so as to clear the tubing bender. Slip the insulation back together and vapor seal the joint with tape. Coil any excess tubing in a horizontal plane with the slope of the tubing toward the condensing unit.

CAUTION: 1. Be careful not to tear the insulation when pushing it through hole in masonry or frame walls. 2. When sealing the tube opening in house wall, use a soft material to prevent tube damage and vibration transmission. 3. Avoid excessive bending in any one place to avoid kinking.

STEP 2--The tubing ends should be cut square. Make sure it is round and free of burrs at the connecting ends. Clean the tubing to prevent contaminants from entering the system.

NOTE: DO NOT BRAZE LINE TO UNITS! If orifice needs to be changed, change out orifice first.

If the orifice does not have to be changed, skip the instructions outlined further in Step 3 and proceed to Step 8.

STEP 3--Disassemble Flow Control Assembly by turning body hex.

STEP 4--If existing orifice has not dropped out of the body when disassembled, remove by using a pin or paper clip. Discard this original orifice.

STEP 5--Insert proper sized orifice fully into the flow control body with rounded "bullet" nose towards the unit as shown. Insure the orifice stays inserted in body before connecting mating half. See chart in the outdoor unit installation instructions for proper size.

CAUTION: Be sure there is no dirt introduced into the flow control--orifice assembly. Be sure and install the orifice with the bullet nose pointing in the proper direction as shown in Figure 4. Failure to do so will result in improper operation.

FIGURE 4
FLOW CONTROL ASSEMBLY
FIELD ORIFICE REPLACEMENT INSTRUCTIONS

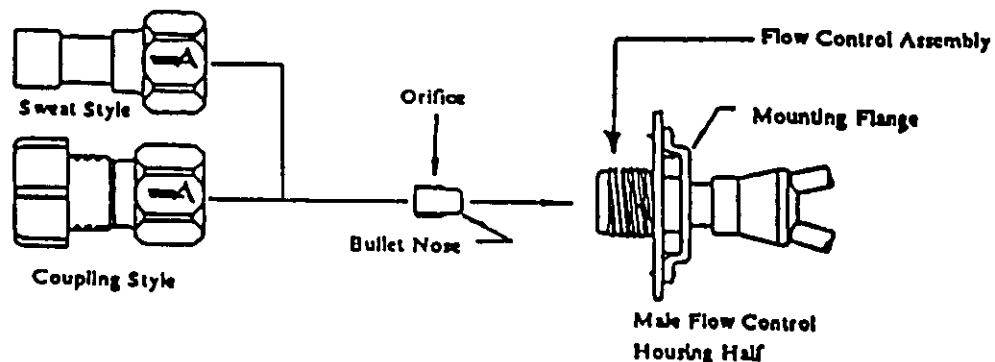

STEP 6--Thread assembly halves together by hand to insure proper mating of threads and tighten until bodies "bottom" or a definite resistance is felt.

STEP 7--Using a marker pen or ink pen, mark a line lengthwise from the union nut to the bulkhead. Then tighten an additional 1/6 turn (or 1 hex flat). The misalignment of the line will show the amount the assembly has been tightened. This final 1/6 turn is necessary to insure the formation of the leakproof joint.

STEP 8--Wrap a wet rag around the copper stub before brazing.

STEP 9--Flux the copper tube and insert into the stub. Braze the joint using an alloy of silver or copper and phosphorus with a melting temperature above 1100°F for copper to copper joints. The phosphorus will act as a flux, therefore, no flux will be required.

A copper-silver alloy with a high silver content should be used when iron or steel material is involved in the joint. These alloys require the use of silver solder flux. Alloys containing phosphorus should not be used with iron or steel. Phosphorus reacts with the iron, forming iron phosphate which is extremely brittle.

CAUTION: 1. Brazing alloys with a melting temperature below 700°F should not be used. 2. Lead-tin or tin-antimony solders should not be used due to their low melting point and necessity for corrosive fluxes.

To further prevent the formation of copper oxide inside the tubing, dry nitrogen may be purged through the refrigerant system during brazing.

WARNING: Never purge or pressurize a system with oxygen. An explosion and fire will result.

STEP 10--After brazing, quench with wet rag to cool the joint and remove any flux residue.

STEP 11--Leak test all connections using an electronic leak detector or a halide torch.

STEP 12--Evacuate suction line, liquid line, and indoor unit through outdoor unit base valves.

STEP 13--Open both the suction and liquid base valves to the fully open position. Refer to section later in installation instructions for details on setting proper system charge.

TABLE 3A

Basic Condensing Unit Model	SWEAT STYLE TUBING CONNECTIONS Refrigerant Line Length (Ft.)		
	0 - 20	21 - 60	61 - 100
	Liquid & Suction	Liquid & Suction	Liquid & Suction
All	3/8 & 3/4	3/8 & 7/8	1/2 & 7/8

FIELD FABRICATED TUBING CONNECTIONS: QUICK CONNECT INDOOR UNIT AND SWEAT OUTDOOR UNIT USING CTO KIT

Use only refrigeration grade (dehydrated and sealed) copper tubing. Care must be taken to insure that the tubing is kept clean and dry before and during installation. Do not remove the plugs from the tubing ends, coil connections or base valves until the connection is ready to be brazed.

The suction line must be insulated with a minimum of 3/8" Armaflex or equivalent before cutting and making connections.

STEP 1--Being careful not to kink, route both the suction line and liquid line between the indoor unit and outdoor unit. Use a tubing bender to make any necessary bends in tubing. When necessary to bend the insulated tube suction line, cut the insulation around its circumference at a distance far enough beyond the point of the bend so as to clear the tubing bender. Slip the insulation back together and vapor seal the joint with tape. Coil any excess tubing in a horizontal place with the slope of the tubing toward the condensing unit.

CAUTION: 1. Be careful not to tear the insulation when pushing it through hole in masonry or frame walls. 2. When sealing the tube opening in house wall, use a soft material to prevent tube damage and vibration transmission. 3. Avoid excessive bending in any one place to avoid kinking.

STEP 2--The tubing ends should be cut square. Make sure it is round and free of burrs at the connecting ends. Clean the tubing to prevent contaminants from entering the system.

NOTE:	DO NOT make any tubing connection at indoor unit at this time. Make all brazing of joints and evacuate both suction and liquid line first.
--------------	--

STEP 3--Wrap a wet rag around the copper stub before brazing.

STEP 4--Flux the copper tube and insert into the stub. Braze the joint using an alloy of silver or copper and phosphorus with a melting temperature above 1100°F for copper to copper joints. The phosphorus will act as a flux, therefore, no flux will be required.

A copper-silver alloy with a high silver content should be used when iron or steel material is involved in the joint. These alloys require the use of silver solder flux. Alloys containing phosphorus should not be used with iron or steel. Phosphorus reacts with iron, forming iron phosphate which is extremely brittle.

CAUTION: 1. Brazing alloys with a melting temperature below 700°F should not be used. 2. Lead-tin or tin-antimony solders should not be used due to their low melting point and necessity for corrosive fluxes.

To further prevent the formation of copper oxide inside the tubing, dry nitrogen may be purged through the refrigerant system during brazing.

WARNING: Never purge or pressurize a system with oxygen. An explosion and fire will result.

STEP 5--After brazing, quench with wet rag to cool the joint and remove any flux residue.

STEP 6--Leak test all connections using an electronic leak detector or a halide torch.

STEP 7--Evacuate suction line and liquid line through outdoor unit base valves.

If orifice does not have to be changed, skip the instructions outlined further in Step 8 and proceed to Step 15.

STEP 8--Recover charge from the indoor unit.

- A. Connect the suction line only to the indoor unit as outlined in Steps 15, 16 and 17.
- B. Recover indoor unit and suction line unit charge through service port located on outdoor unit base valve.

STEP 9--Disassemble Flow Control Assembly by turning body hex.

STEP 10--If existing orifice has not dropped out of the body when disassembled, remove by using a pin or paper clip. Discard this original orifice.

STEP 11--Insert proper sized orifice fully into the flow control body with rounded "bullet" nose towards the unit as shown. Insure the orifice stays inserted in body before connecting mating half. See chart in the outdoor unit installation instructions for proper size.

CAUTION: Be sure there is no dirt introduced into the flow control--orifice assembly. Be sure and install the orifice with the bullet nose pointing in the proper direction as shown in Figure 4. Failure to do so will result in improper operation.

STEP 12--Thread assembly halves together by hand to insure proper mating of threads and tighten until bodies "bottom" or a definite resistance is felt.

STEP 13--Using a marker pen or ink pen, mark a line lengthwise from the union nut to the bulkhead. Then tighten an additional 1/6 turn (or 1 hex flat). The misalignment of the line will show the amount the assembly has been tightened. This final 1/6 turn is necessary to insure the formation of the leakproof joint.

STEP 14--Evacuate the suction line and indoor unit through the outdoor unit base valve before connecting all other tubing. Refer to section later in installation instructions for details on setting the proper refrigerant charge.

STEP 15--Remove (remaining) protector caps and plugs (if orifice was changed). Inspect fittings and if necessary carefully wipe coupling seats and threaded surfaces with a clean cloth to prevent the inclusion of dirt or any foreign material in the system.

STEP 16--Lubricate male half diaphragm and synthetic rubber seal with refrigerant oil. Thread coupling halves together by hand to insure proper mating of threads. Be sure to hold the coupling firmly to prevent movement of the coupling and tubing. Failure to do so could tear out the diaphragm causing a blockage of the system. Use proper size wrenches (on coupling body hex and on union nut) and tighten until coupling bodies "bottom" or a definite resistance is felt.

CAUTION: After starting to tighten up the fitting, never try to back it off or take it apart.

STEP 17--Using a marker or ink pen, mark a line lengthwise from the coupling union nut to the bulkhead. Then tighten an additional 1/4 turn: The misalignment of the line will show the amount the coupling has been tightened. This final 1/4 turn is necessary to insure the formation of leak proof joint. If a torque wrench is used, the following torque values are recommended.

TABLE 4

Coupling Size	Ft. Lbs.
-6	10 - 12
-10	35 - 45
-11	35 - 45
-12	50 - 65

STEP 18--Leak test all connections using an electronic leak detector or a halide torch.

STEP 19--When tubing is installed in attics or drop ceilings, insulate the couplings on the larger tube thoroughly with 3/8" wall thickness, closed cell sponge tube insulation or equivalent. Failure to insulate will result in water damage to ceiling since the fitting will "sweat" and drop water on the ceiling.

STEP 20--Open both the suction and liquid base valves to the fully open position. Refer to section later in installation instructions for details on setting proper system charge.

II. WIRING INSTRUCTIONS

GENERAL

All wiring must be installed in accordance with the National Electrical Code and local codes. In Canada, all wiring must be installed in accordance with the Canadian Electrical Code and in accordance with the regulations of the authorities having jurisdiction. Power supply voltage must conform to the voltage shown on the unit serial plate. A wiring diagram of the unit is attached to the inside of the electrical cover. The power supply shall be sized and fused according to the specifications supplied. A ground lug is supplied in the control compartment for equipment ground.

The unit rating plate lists a "Maximum Time Delay Fuse" or "BACR Type" circuit breaker that is to be used with the equipment. The correct size must be used for proper circuit protection and also to assure that there will be no nuisance tripping due to the momentary high starting current of the compressor motor.

CONTROL CIRCUIT WIRING

For split systems, the minimum control circuit wiring gauge needed to insure proper operation of all controls in both indoor and outdoor units will depend on two factors.

1. The rated VA of the control circuit transformer.
2. The maximum total distance of the control circuit wiring. (This is the distance between the wall thermostat to the indoor unit plus the distance between the indoor unit to the outdoor unit.)

The following table should be used to determine proper gauge of control circuit wiring required.

TABLE 5

Rated VA of Control Circuit Transformer	Transformer Secondary FLA @ 24V	Maximum Total Distance of Control Circuit Wiring In Feet
40	1.6	20 gauge - 65 18 gauge - 90 16 gauge - 145 14 gauge - 230
50	2.1	20 gauge - 45 18 gauge - 60 16 gauge - 100 14 gauge - 160 12 gauge - 250
65	2.7	20 gauge - 40 18 gauge - 55 16 gauge - 85 14 gauge - 135 12 gauge - 210

Example: 1. Control circuit transformer rated at 40VA.

2. Maximum total distance of control circuit wiring 85 feet.

From Table 5, minimum of 18 gauge wire should be used in the control circuit wiring.

For control circuit transformers rated other than those listed, use the next lower rated transformer listed.

Example: 1. Control circuit transformer rated at 55VA.

From table use 50VA transformer.

There are two (2) separate control diagrams for fossil fuel furnaces with air conditioners.

Control diagrams for the various circuits which could be encountered with blower coils can be found in the installation instructions of the blower coil.

TABLE 6

System	Gas Furnace Control Diagram	Oil Furnace Control Diagram
All Models	4091-100	4091-101

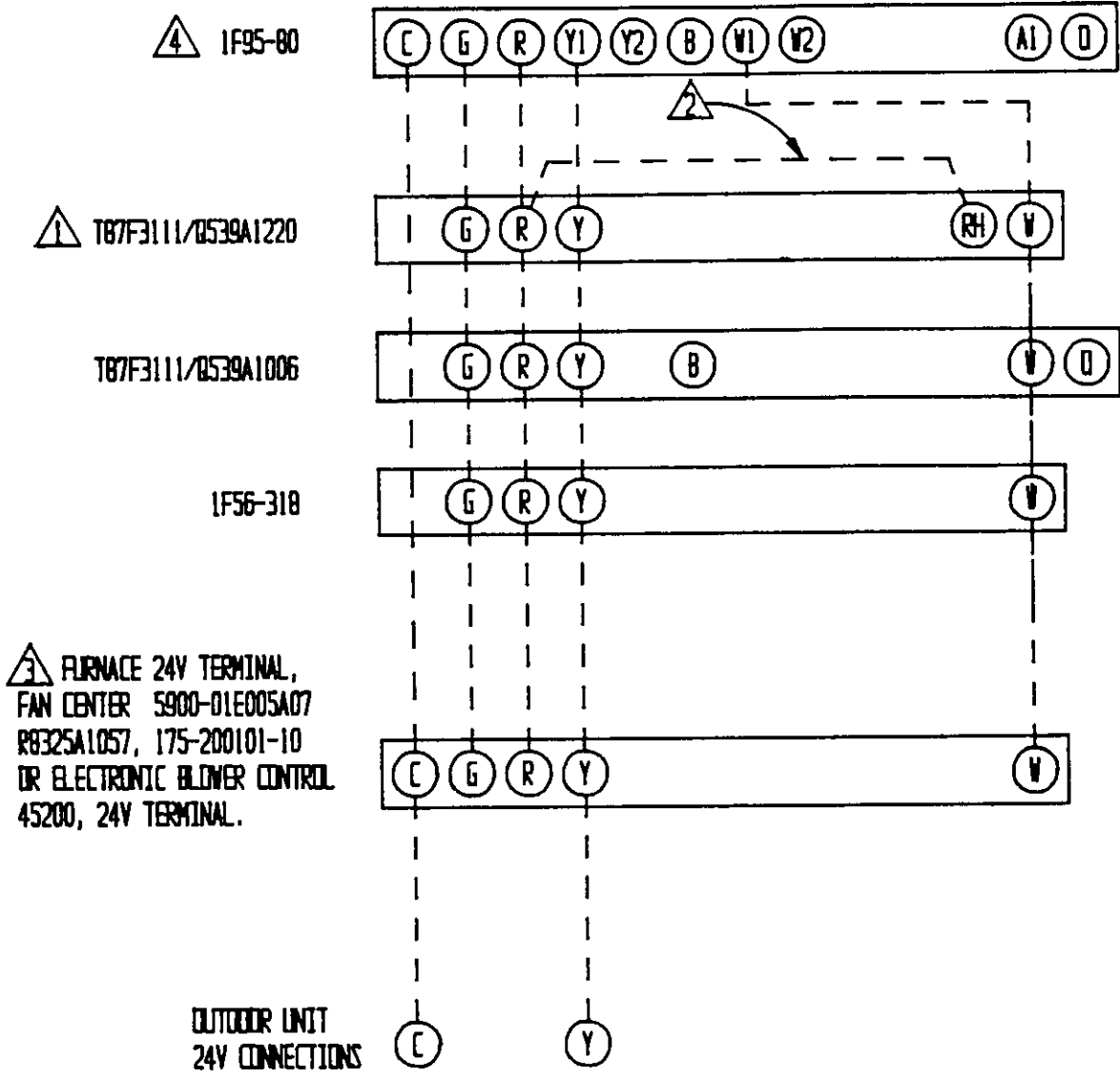

- △ SET ADJUST HEAT ANTICIPATOR (SEE FURNACE INSTALLATION INSTRUCTIONS)
- △ INSTALL JUMPER R-RH
- △ IF THE FURNACE IS NOT INTERNALLY WIRED FOR ADD ON AIR CONDITIONING, A FAN CENTER WILL NEED TO BE ADDED.
- △ OPTION SWITCH SETTING

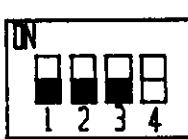

SWITCH #1 "OFF"
SWITCH #2 "OFF"
SWITCH #3 "OFF"
SWITCH #4 SEE THERMOSTAT
INSTALLATION INSTRUCTIONS

	FACTORY WIRING	FIELD WIRING
LOW VOLTAGE	_____	-----
HIGH VOLTAGE	_____	-----

AIR CONDITIONER W/GAS FURNACE

⚠ T87F3111/Q539A1220

⚠ FURNACE 24V TERMINAL
 FAN CENTER 5900-01E005A07
 R8325A1057, 175-200101-10
 OR ELECTRONIC BLOWER CONTROL
 45200, 24V TERMINAL.

OUTDOOR UNIT
 24V CONNECTIONS

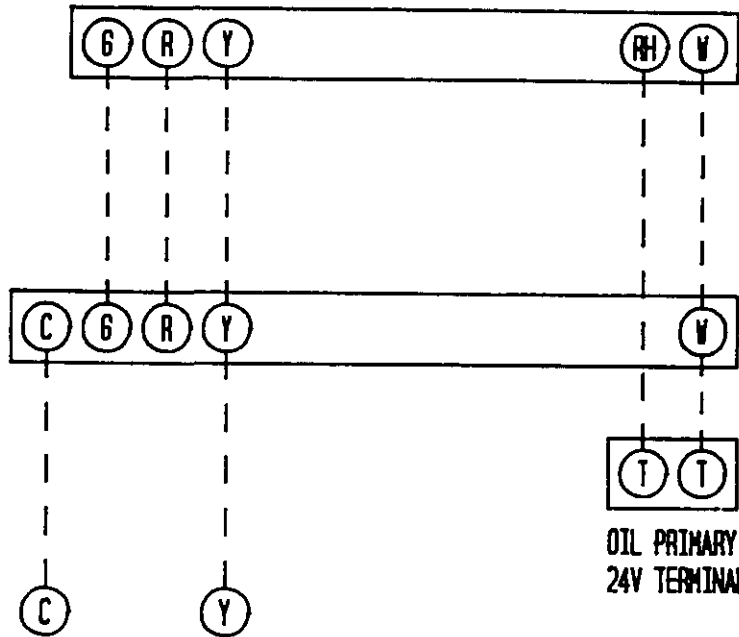

⚠ SET ADJUST HEAT ANTICIPATOR (SEE FURNACE INSTALLATION INSTRUCTIONS)

⚠ IF THE FURNACE IS NOT INTERNALLY WIRED FOR ADD ON AIR CONDITIONING, A FAN CENTER WILL NEED TO BE ADDED.

	FACTORY WIRING	FIELD WIRING
LOW VOLTAGE	_____	-----
HIGH VOLTAGE	=====	-----

AIR CONDITIONER W/OIL FURNACE

4091-101 A

WALL THERMOSTATS

The following wall thermostats and subbases should be used as indicated, depending on the application.

TABLE 7

AIR CONDITIONING THERMOSTATS		
Part No.	Model No.	Description
8403-002	T87F3111	THERMOSTAT--1 stg. heat, adj. heater, Mercury
8404-003	Q539A1220	SUBBASE --System Heat-Off-Cool Fan: On-Auto
8403-008	ID51-605	THERMOSTAT--1 stg. cool, System w/Off Sw. Snap Action Fan: Auto-On
8403-009	IF56-318	THERMOSTAT--1 st. cool, 1 stg. heat, Adj. heater Mercury System: Heat-Off-Cool Fan: Auto-On
8403-019	T874C1000	THERMOSTAT--1 stg. cool, 2 stg. heat, Adj. heater, Mercury
8404-012	Q674A1001	SUBBASE --System: Heat-Auto-Cool Fan: Auto-On

III. CHARGING INSTRUCTIONS

PRESSURE SERVICE PORTS

High and low pressure service ports are installed on all units so that the system operating pressures can be observed. Pressure tables can be found later in the manual covering all models. It is imperative to match the correct pressure table to the unit by model number.

SYSTEM START-UP (INDOOR UNITS WITHOUT EXPANSION VALVES)

STEP 1--Close disconnect switch(es) and set the thermostat to cool and the temperature to the highest setting.

STEP 2--Check for proper airflow across the indoor coil by referring to indoor unit installation instructions.

STEP 3--Connect the service gauges and allow the unit to run for at least 10 minutes or until pressures are stable. Check pressures to the system pressure table attached to the outdoor unit service panel. For optimum system performance, go to Step 4.

STEP 4--Install a thermometer on the suction line approximately 6" to 10" from the compressor. Optimum system performance will occur with a refrigerant charge resulting in a suction line superheat as determined from the following calculations.

- A. Measure outdoor air dry bulb temperature _____ °F
- B. Measure indoor air wet bulb temperature _____ °F
- C. Measure suction pressure _____ PSIG
- D. Measure suction line temperature _____ °F
- E. Determine optimum system superheat from Table 9 using outdoor air dry bulb (Step B) and indoor air wet bulb (Step A). _____ °F
- F. Determine saturated suction temperature from suction pressure using Table 8. _____ °F
- G. Determine system superheat:
 - Suction line temperature (Step D) _____ °F
 - Saturated suction temperature (Step F) _____ °F
 - System superheat _____ °F
- H. Adjust the system superheat (Step G) to the optimum system superheat (Step E) by adding charge to lower the superheat or removing charge to raise the superheat.
- I. Check final system operating pressures to the system pressure tables as was done in Step 3.

TABLE 8 SATURATED SUCTION TEMPERATURE (R-22)

Suction Pressure PSIG	Saturated Suction Temperature (Deg. F)
50	26
53	28
55	30
58	32
61	34
63	36
65	38
67	39
70	41
73	43
76	45
79	47
82	49
86	51

TABLE 9 SYSTEM SUPERHEAT

Outdoor Ambient Temperature (Deg. F Dry Bulb)	Return Air Temperature Deg. F--Wet Bulb			
	59	63	67	71
105	1	1	5	
95	1	3	(8)	20
90	1	7	14	26
85	3	9	19	33
80	8	14	25	39
75	10	20	30	42

SYSTEM START-UP (TXV INDOOR UNITS WITH EXPANSION VALVES)

STEP 1--Close disconnect switch(es) and set the thermostat to cool and the temperature to the highest setting.

STEP 2--Check for proper airflow across the indoor coil by referring to indoor unit installation instructions.

STEP 3--Connect the service gauges and allow the unit to run for at least 10 minutes or until pressures are stable. Check pressures to the system pressure table attached to the outdoor unit service panel. For optimum system performance, go to Step 4.

NOTE: Use a digital thermometer for all temperature measurements.

STEP 4--Install a thermometer on the liquid line approximately 4" to 6" from the base valve or quick connect on the outside of the unit. Optimum system performance will occur with a refrigerant charge resulting in a liquid line subcooling as determined from the following calculations.

- A. Measure liquid pressure _____ PSIG
- B. Measure liquid line temperature _____ °F
- C. Determine optimum system subcooling from Table 10 _____ °F
- D. Determine saturated liquid temperature from liquid pressure using Table 11. _____ °F
- E. Determine system subcooling:
- | | |
|---------------------------------------|------------|
| Saturated liquid temperature (Step D) | _____ °F |
| - Liquid line temperature (Step B) | - _____ °F |
| - System subcooling | = _____ °F |
- F. Adjust the system subcooling to the optimum system subcooling by adding charge to increase subcooling or removing charge to decrease subcooling. (Allow tolerance of $\pm 3^\circ\text{F}$)

TABLE 10 REQUIRED SYSTEM SUBCOOLING

Outdoor Section	Indoor Section	
4812UACSB	A61XS-A	13°
4812UACSB	BC6OBX	12°
6012UACSB	A61XS-A	17°
6012UACSB	BC6OBX	15°

TABLE 11 SATURATED LIQUID TEMPERATURE

Liquid Pressure	Saturated Liquid Temperature (Degree F)	Liquid Pressure	Saturated Liquid Temperature (Degree F)
182	95	253	118
185	96	256	119
187	97	260	120
190	98	263	121
193	99	267	122
196	100	271	123
199	101	274	124
202	102	278	125
205	103	282	126
208	104	285	127
211	105	289	128
214	106	293	129
217	107	297	130
220	108	301	131
223	109	305	132
226	110	309	133
230	111	313	134
233	112	317	135
236	113	321	136
239	114	325	137
243	115	329	138
246	116	333	139
250	117	337	140

TABLE 12

TOTAL SYSTEM OPERATING CHARGE (Includes charge for the basic outdoor unit, indoor coil and 25' of interconnecting tubing)		
Outdoor Section	Indoor Section	Total R-22 Charge (Oz.)
2412UACSB	A36AS-A	107 oz.
	BC24B	116 oz.
3012UACSB	A36AS-A	100 oz.
	BC30B	102 oz.
	BC36B	110 oz.
3612UACSB	A36AS-A	162 oz.
	A37AS-A	173 oz.
	BC36B	172 oz.
4212UACSB	A48AS-A	213 oz.
	BC36B	197 oz.
4812UACSB	A61XS-A	227 oz.
	BC60BX	227 oz.
6012UACSB	A61XS-A	234 oz.
	BC60BX	234 oz.

The above includes 25' of 3/8" diameter liquid line. For other than 25' and other tube sizes, adjust the total charge according to the following schedule.

<u>Liquid Line Diameter</u>	<u>Oz. R-22 Per Ft.</u>
3/8"	.6
1/2"	1.2

INSTALLER NOTE: Stamp or mark the final system charge determined above on the outdoor unit serial plate.

IV. SERVICE

SERVICE HINTS

1. Caution homeowner to maintain clean air filters at all times. Also, not to needlessly close off supply and return air registers. This reduces air flow through the system, which shortens equipment service life as well as increasing operating costs.
2. Check all power fuses or circuit breakers to be sure that they are the correct rating.
3. Periodic cleaning of the outdoor coil to permit full and unrestricted air flow circulation is essential.

FAN BLADE SETTING DIMENSIONS

Shown in the drawing below are the correct fan blade setting dimensions for proper air delivery across the outdoor coil.

Any service work requiring removal or adjustment in the fan and/or motor area will require that the dimensions below be checked and blade adjusted in or out on the motor shaft accordingly.

FIGURE 7

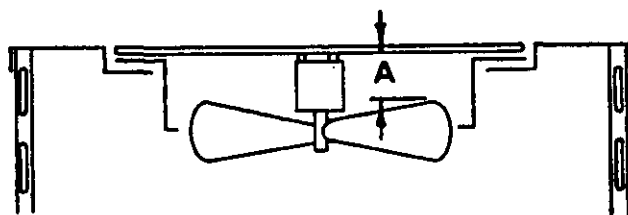
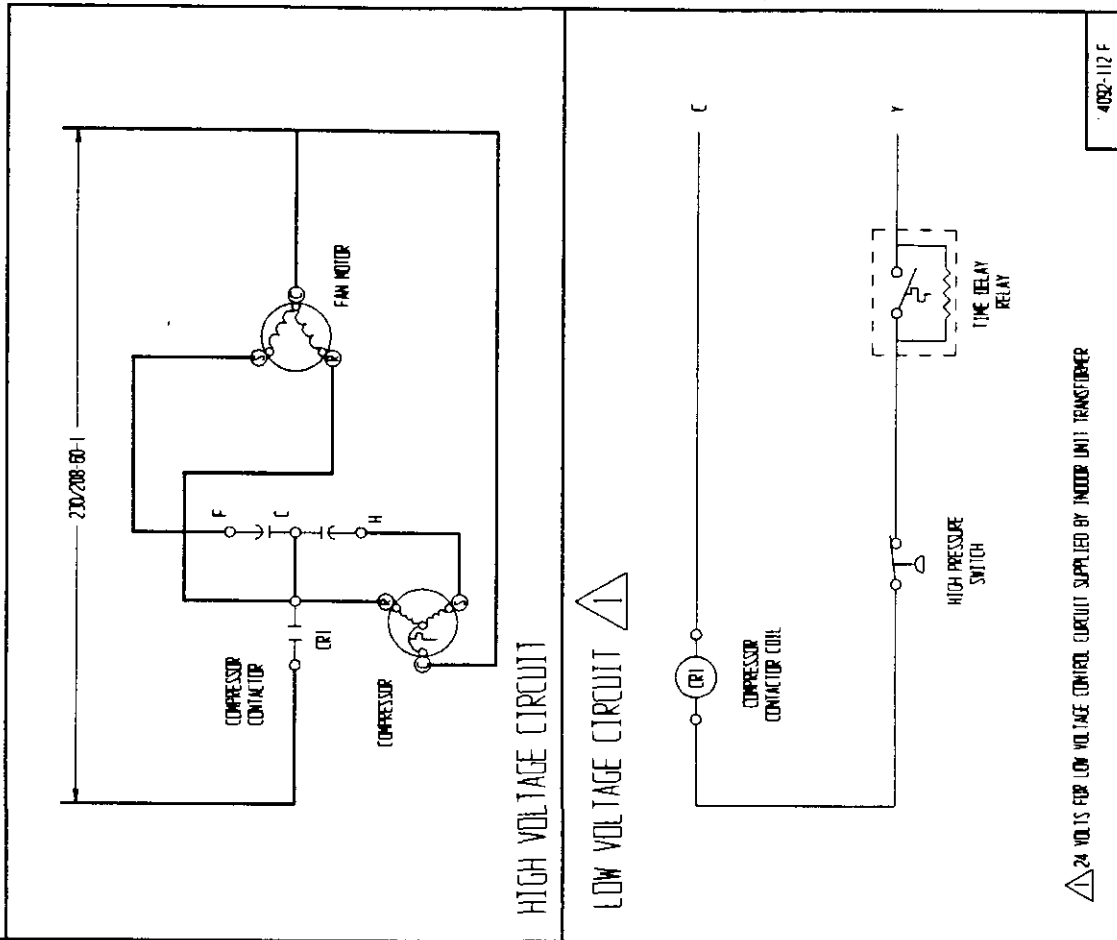
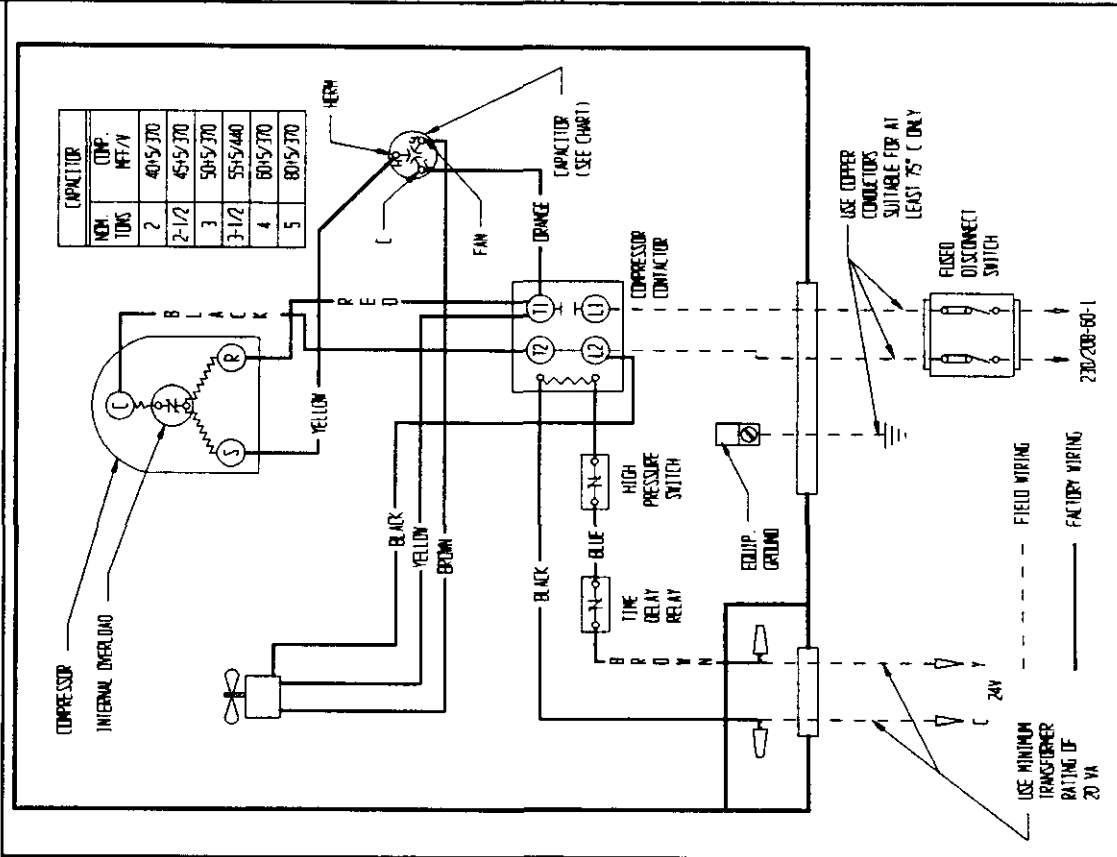

TABLE 13

Model	Dimension A
2412UACSB 3012UACSB 3612UACSB 4212UACSB 4812UACSB	3-1/2
6012UACSB	4

UNBRAZING SYSTEM COMPONENTS

If the refrigerant charge is removed from a scroll equipped unit by bleeding the high side only, it is sometimes possible for the scrolls to seal, preventing pressure equalization through the compressor. This may leave low side shell and suction line tubing pressurized. If the brazing torch is then applied to the low side while the low side shell and suction line contains pressure, the pressurized refrigerant and oil mixture could ignite when it escapes and contacts the brazing flame. To prevent this occurrence, it is important to check both the high and low side with manifold gauges before unbrazing.



COOLING			Air Temperature Entering Outdoor Coil Degree F								
Model	Return Air Temperature	Pressure	°	°	°	°	°	°	°	°	°
			75	80	85	90	95	100	105	110	115
A36AS-A Rated CFM 820	75 deg. DB	Low Side	68	71	73	75	77	78	79	80	80
	62 deg. WB	High Side	165	179	194	209	224	240	256	273	291
	80 deg. DB	Low Side	74	76	78	80	82	83	85	85	86
	67 deg. WB	High Side	170	184	199	214	230	246	263	281	299
BC24B Rated CFM 775	85 deg. DB	Low Side	80	82	84	86	88	89	91	91	92
	72 deg. WB	High Side	177	191	206	222	238	255	272	290	309
	75 deg. DB	Low Side	72	73	75	76	77	78	79	80	81
	62 deg. WB	High Side	172	186	201	215	230	245	260	276	292
BC24B Rated CFM 775	80 deg. DB	Low Side	78	79	81	82	83	84	85	86	87
	67 deg. WB	High Side	177	191	206	221	236	252	267	284	300
	85 deg. DB	Low Side	84	85	87	88	89	90	91	92	93
	72 deg. WB	High Side	183	198	213	228	244	260	276	293	310

COOLING			Air Temperature Entering Outdoor Coil Degree F								
Model	Return Air Temperature	Pressure	°	°	°	°	°	°	°	°	°
			75	80	85	90	95	100	105	110	115
A36AS-A Rated CFM 1050	75 deg. DB	Low Side	70	71	73	74	75	76	77	78	79
	62 deg. WB	High Side	172	183	196	209	224	240	257	276	296
	80 deg. DB	Low Side	74	76	78	80	81	82	83	84	85
	67 deg. WB	High Side	177	188	201	215	230	247	264	284	304
BC30B Rated CFM 800	85 deg. DB	Low Side	80	82	84	86	87	88	89	90	91
	72 deg. WB	High Side	182	194	207	222	238	255	274	294	315
	75 deg. DB	Low Side	66	68	69	70	71	72	73	74	75
	62 deg. WB	High Side	167	182	197	213	229	245	262	278	295
BC36B Rated CFM 1050	80 deg. DB	Low Side	71	76	74	75	76	77	78	79	80
	67 deg. WB	High Side	171	187	203	219	235	252	268	286	303
	85 deg. DB	Low Side	76	78	79	80	81	82	83	85	86
	72 deg. WB	High Side	176	192	209	226	243	260	278	295	313
BC36B Rated CFM 1050	75 deg. DB	Low Side	72	73	75	76	77	78	79	79	80
	62 deg. WB	High Side	166	181	196	211	227	243	259	275	292
	80 deg. DB	Low Side	76	78	80	82	83	84	85	86	86
	67 deg. WB	High Side	171	186	201	217	233	249	266	283	300
BC36B Rated CFM 1050	85 deg. DB	Low Side	82	84	86	88	89	90	91	92	92
	72 deg. WB	High Side	177	193	208	225	241	258	275	292	310

Low side pressure \pm 2 PSIG (suction line @ outdoor unit base valve)

High side pressure \pm 5 PSIG (liquid line @ outdoor unit base valve)

Tables are based upon rated CFM (airflow) across the evaporator coil and should be found under section titled "Refrigerant Charge" elsewhere in manual. If there is any doubt as to correct operating charge being in the system, the charge should be removed, system evacuated, and recharged to serial plate instructions.

COOLING			Air Temperature Entering Outdoor Coil Degree F								
Model	Return Air Temperature	Pressure	°	°	°	°	°	°	°	°	°
			75	80	85	90	95	100	105	110	115
A36AS-A Rated CFM 1200	75 deg. DB	Low Side	66	68	70	72	73	74	75	76	77
	62 deg. WB	High Side	168	183	198	214	231	248	266	284	302
	80 deg. DB	Low Side	71	73	75	77	78	79	80	81	82
	67 deg. WB	High Side	172	188	204	220	237	254	272	291	310
A37AS-A Rated CFM 1200	85 deg. DB	Low Side	76	78	80	82	84	85	87	87	88
	72 deg. WB	High Side	177	193	210	227	245	263	282	301	320
	75 deg. DB	Low Side	69	71	73	75	77	79	80	81	82
	62 deg. WB	High Side	173	189	205	221	238	255	272	290	308
BC36B Rated CFM 1200	80 deg. DB	Low Side	74	76	78	80	82	84	85	87	88
	67 deg. WB	High Side	177	193	210	227	244	262	279	298	316
	85 deg. DB	Low Side	80	82	84	86	88	90	92	93	95
	72 deg. WB	High Side	184	200	217	234	252	270	289	308	327
BC36B Rated CFM 1200	75 deg. DB	Low Side	66	67	69	70	72	74	75	77	78
	62 deg. WB	High Side	168	184	199	215	230	245	261	276	292
	80 deg. DB	Low Side	71	72	74	75	77	79	80	82	83
	67 deg. WB	High Side	173	189	204	220	236	252	268	283	299
BC36B Rated CFM 1200	85 deg. DB	Low Side	76	77	79	80	82	84	85	87	88
	72 deg. WB	High Side	178	194	211	227	244	261	277	294	310

COOLING			Air Temperature Entering Outdoor Coil Degree F								
Model	Return Air Temperature	Pressure	°	°	°	°	°	°	°	°	°
			75	80	85	90	95	100	105	110	115
A48AS-A Rated CFM 1325	75 deg. DB	Low Side	65	67	69	71	73	75	76	78	79
	62 deg. WB	High Side	159	174	189	205	221	237	254	271	289
	80 deg. DB	Low Side	70	72	74	76	78	80	82	83	85
	67 deg. WB	High Side	163	179	194	211	227	244	261	278	296
BC36B Rated CFM 1240	85 deg. DB	Low Side	74	77	79	82	84	86	88	90	91
	72 deg. WB	High Side	168	184	201	218	235	252	270	288	306
	75 deg. DB	Low Side	61	64	66	68	70	71	72	73	73
	62 deg. WB	High Side	156	170	185	200	216	232	249	266	283
BC36B Rated CFM 1240	80 deg. DB	Low Side	66	69	71	73	75	76	77	78	78
	67 deg. WB	High Side	160	175	190	206	222	239	256	273	291
BC36B Rated CFM 1240	85 deg. DB	Low Side	70	74	77	79	81	82	83	84	84
	72 deg. WB	High Side	165	181	197	213	230	247	265	283	301

Low side pressure \pm 2 PSIG (suction line @ outdoor unit base valve)

High side pressure \pm 5 PSIG (liquid line @ outdoor unit base valve)

Tables are based upon rated CFM (airflow) across the evaporator coil and should be found under section titled "Refrigerant Charge" elsewhere in manual. If there is any doubt as to correct operating charge being in the system, the charge should be removed, system evacuated, and recharged to serial plate instructions.

4812UACSB

TABLE 18

COOLING			Air Temperature Entering Outdoor Coil Degree F								
Model	Return Air Temperature	Pressure	°	°	°	°	°	°	°	°	°
			75	80	85	90	95	100	105	110	115
A61XS-A Rated CFM 1600	75 deg. DB	Low Side	75	76	76	77	78	79	80	82	83
	62 deg. WB	High Side	168	181	196	211	227	244	262	280	300
	80 deg. DB	Low Side	79	81	82	83	84	85	86	88	89
	67 deg. WB	High Side	172	186	201	217	233	250	268	287	307
	85 deg. DB	Low Side	86	87	88	89	90	91	93	94	96
	72 deg. WB	High Side	179	193	208	224	241	259	278	297	318
BC60BX Rated CFM 1600	75 deg. DB	Low Side	76	77	79	80	81	82	83	83	84
	62 deg. WB	High Side	165	179	194	210	226	243	261	279	298
	80 deg. DB	Low Side	82	83	85	86	87	88	89	89	90
	67 deg. WB	High Side	169	184	199	215	232	249	268	286	306
	85 deg. DB	Low Side	87	89	91	93	94	95	96	97	97
	72 deg. WB	High Side	176	191	206	223	240	258	277	297	317

6012UACSB

TABLE 19

COOLING			Air Temperature Entering Outdoor Coil Degree F								
Model	Return Air Temperature	Pressure	°	°	°	°	°	°	°	°	°
			75	80	85	90	95	100	105	110	115
A61XS-A Rated CFM 1780	75 deg. DB	Low Side	75	76	76	77	78	79	80	80	81
	62 deg. WB	High Side	177	193	209	226	243	261	280	299	319
	80 deg. DB	Low Side	80	81	81	82	83	84	85	86	87
	67 deg. WB	High Side	183	199	215	231	249	267	286	306	327
	85 deg. DB	Low Side	86	87	87	88	89	90	91	93	94
	72 deg. WB	High Side	189	205	222	240	258	277	297	317	338
BC60BX Rated CFM 1800	75 deg. DB	Low Side	75	76	76	77	78	79	80	80	81
	62 deg. WB	High Side	177	192	207	224	241	259	278	298	318
	80 deg. DB	Low Side	79	80	82	83	84	85	86	86	87
	67 deg. WB	High Side	182	197	213	229	247	265	285	305	326
	85 deg. DB	Low Side	85	87	88	89	90	91	92	93	94
	72 deg. WB	High Side	187	203	220	238	256	275	295	316	337

Low side pressure \pm 2 PSIG (suction line @ outdoor unit base valve)

High side pressure \pm 5 PSIG (liquid line @ outdoor unit base valve)

Tables are based upon rated CFM (airflow) across the evaporator coil and should be found under section titled "Refrigerant Charge" elsewhere in manual. If there is any doubt as to correct operating charge being in the system, the charge should be removed, system evacuated, and recharged to serial plate instructions.

