

INSTALLATION INSTRUCTIONS

WALL MOUNTED PACKAGE HEAT PUMPS

MODELS

45WH1

48WH6

60WH1

(Suffix D016 Models)

MANUAL 2100-177 REV.
SUPERSEDES REV.
FILE VOL. III, TAB 17

COPYRIGHT FEBRUARY, 1991
BARD MANUFACTURING COMPANY
BRYAN, OHIO

INDEX

Important	3
Shipping Damage	3
General	3
Installation	3
Duct Work	3
Filter	3
Fresh Air Intake	4
Wall Mounting	4
Wiring--Main Power	4
Wiring--24V Control Circuit	5
Condensate Drain	5
Compressor Malfunction Relay (Single Phase Models Only)	5
Pressure Service Ports	5
Sequence of Operation	5
Compressor Cut-Off Thermostat and Outdoor Thermostats	6
Compressor Cut-Off and Outdoor Thermostat Wiring	6
Heat Anticipation	6
Thermostat Indicator Lamps	6
Emergency Heat Posisiton	6
Defrost Cycle	7
Low Pressure Switch	8
Compressor Time Delay	8
Service Hints	8
Important Installer Note	8
Crankcase Heaters	8
Mounting Instructions	10
Fan Blade Setting Dimensions	11
Refrigerant Charge	11
Compressor Cut-Off and Outdoor Thermostat Wiring	13

INDEX OF FIGURES AND TABLES

Figure 1	1
Figure 2	5
Figure 3	7
Figure 4	8
Figure 5	9
Figure 6	10
Figure 7	11
Figure 8	13
Figure 9	13

Table 1	2
Table 2	6
Table 3	11
Table 4	12
Table 5	12
Table 6	14
Table 7	14

FIGURE 1

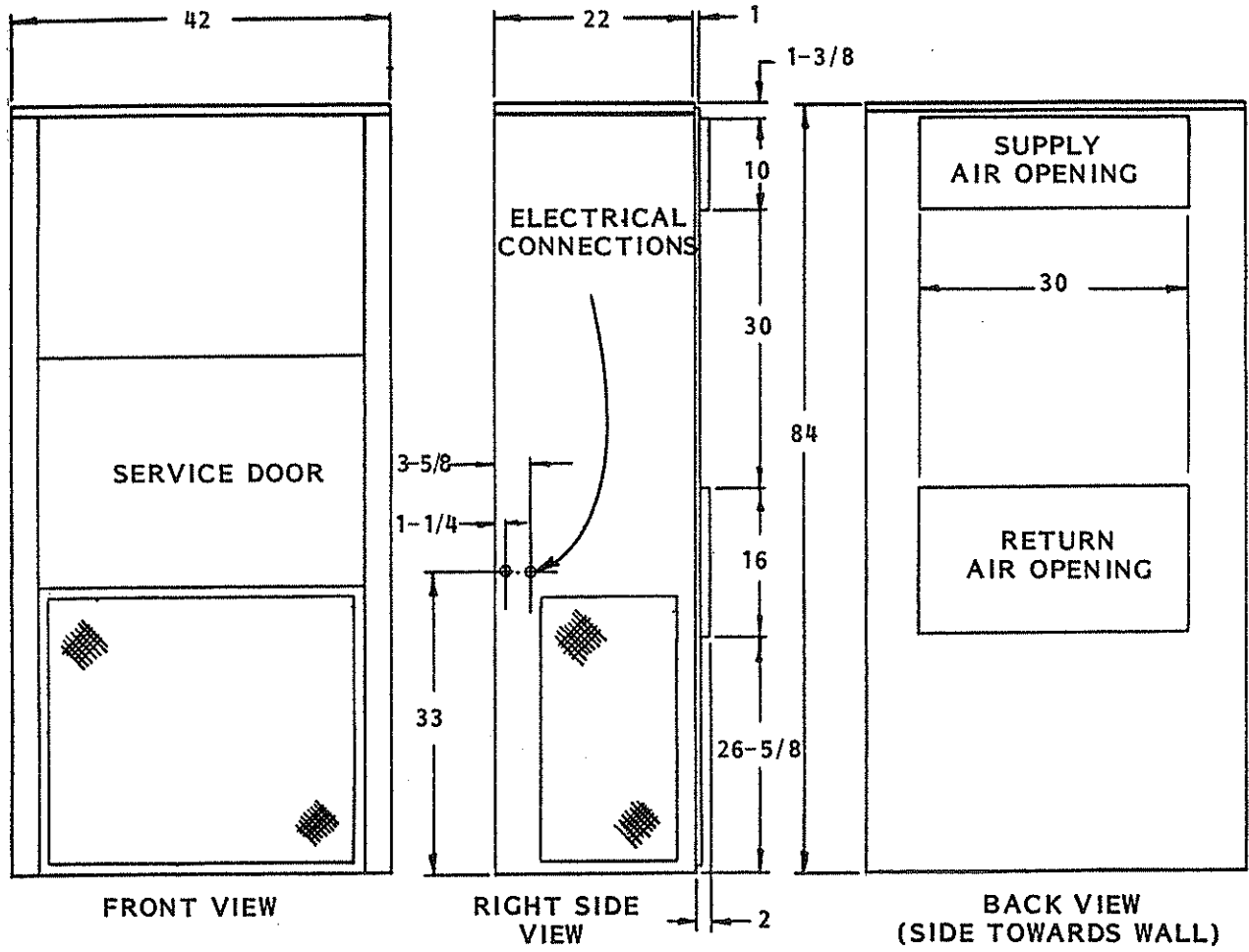

ELECTRICAL SPECIFICATIONS

TABLE 1

Model	Rated Volts & Phase	Max. Unit Amps @ 240/208V	No. Field Power Ckts.	(2) Max. Ext. Fuse or Circuit Breaker			(3) Min. Circuit Ampacity		
				Ckt.A	Ckt.B	Ckt.C	Ckt.A	Ckt.B	Ckt.C
45WH1-AOOC	230/208	26.3/29.3	1	50			35		
10C(1)	1	67.9/65.5	2	50	60		35	52	
15C		67.9/65.5	3	50	60	30	35	52	26
45WH1-BOOC	230/208	18.8/21.8	1	40			26		
09C(1)	3	40.5/40.5	1	60			53		
15C		40.5/40.5	1	60			53		
45WH1-COOC(1)	460	10.2	1	15			15		
09C	3	21.0	1	30			26		
15C		21.0	1	30			26		
48WH6-AOOC	230/208	28.3/31.3	1	60			38		
10C	1	69.9/67.5	2	60	60		38	52	
15C(1)		90.8/85.4	3	60	60	30	38	52	26
20C		87.2/76.1	3	60	60	60	38	52	52
48WH6-BOOC	230/208	22.8/24.8	1	45			30		
09C	3	44.5/43.5	1	60			58		
15C(1)		59.0/56.0	2	45	50		30	46	
18C		47.3/43.5	2	45	60		30	55	
48WH6-COOC	460	11.8	1	20			15		
09C	3	22.6	1	30			29		
15C(1)		29.8	1	40			37		
60WH1-AOOC	230/208	32.8/37.8	1	60			46		
10C	1	74.4/74.0	2	60	60		46	52	
15C(1)		95.3/91.9	3	60	60	30	46	52	26
20C		87.2/76.1	3	60	60	60	46	52	52
60WH1-BOOC	230/208	25.8/27.8	1	50			34		
09C	3	47.5/46.5	1	60			60		
15C(1)		62.0/59.0	2	50	50		34	46	
18C		47.5/46.5	2	50	60		34	55	
60WH1-COOC	460	12.8	1	25			16		
09C	3	23.6	1	35			30		
15C(1)		30.8	1	40			39		

- (1) Maximum KW that can operate with heat pump on.
- (2) Maximum size of the time delay fuse or HACR type circuit breaker for protection of field wiring conductors. (Sizes 70 amp or greater are not HACR type).
- (3) These "Minimum Circuit Ampacity" values are to be used for sizing the field power conductors. Refer to the National Electrical Code (latest revision) article 310 for power conductor sizing. CAUTION: When more than one field power conductor circuit is run thru one conduit, the conductors must be derated. Pay special attention to Note 8 of Table 310 regarding Ampacity Adjustment Factors when more than 3 conductors are in a raceway.
- (4) All wiring must conform to the National Electrical Code and all local codes.

IMPORTANT

The equipment covered in this manual is to be installed by trained, experienced service and installation technicians. Any heat pump is more critical of proper operating, charge and an adequate duct system than a straight air conditioning unit. All duct work supply and return, must be properly sized for the design air flow requirement of the equipment. ACCA is an excellent guide to proper sizing. All duct work or portions thereof not in the conditioned space should be properly insulated in order to both conserve energy and prevent condensation or moisture damage.

SHIPPING DAMAGE

Upon receipt of equipment, the carton should be checked for external signs of shipping damage. If damage is found, the receiving party must contact the last carrier immediately, preferably in writing, requesting inspection by the carrier's agent.

GENERAL

The refrigerant system is completely assembled and charged. All internal wiring is complete.

The unit is designed for use with or without duct work. Flanges are provided for attaching the supply and return ducts.

These instructions explain the recommended method to install the air cooled self-contained unit and the electrical wiring connections to the unit.

These instructions and any instructions packaged with any separate equipment required to make up the entire air conditioning system should be carefully read before beginning the installation. Note particularly "Starting Procedure" and any tags and/or labels attached to the equipment.

While these instructions are intended as a general recommended guide, they do not supersede any national and/or local codes in any way. Authorities having jurisdiction should be consulted before the installation is made.

INSTALLATION

Size of unit for a proposed installation should be based on heat loss calculation made according to methods of Air Conditioning Contractors of America (ACCA). The air duct should be installed in accordance with the Standards of the National Fire Protection Association for the Installation of Air Conditioning and Ventilating systems of Other Than Residence Type, NFPA No. 90A, and Residence Type Warm Air Heating and Air Conditioning System, NFPA No. 90B. Where local regulations are at a variance with instructions, installer should adhere to local codes.

DUCT WORK

Design the duct work according to methods given by the Air Conditioning Contractors of America. When duct runs through unheated spaces, it should be insulated with a minimum of one inch of insulation. Use insulation with a vapor barrier on the outside of the insulation. Flexible joints should be used to connect the duct work to the equipment in order to keep the noise transmission to a minimum.

For all models incorporating supplementary electric heaters, a one-inch clearance to combustibile material for the first three feet of duct attached to the outlet air frame is required. See Page 9 for further details.

FILTER

A one-inch throwaway filter is supplied with each unit. The filter slides into position making it easy to service. This filter can be serviced from the outside by removing the service door.

FRESH AIR INTAKE

All units are built with a fresh air inlet hole punched in the service panel. The fresh air damper assembly is shipped with each unit, and must be attached at the installation site. See Figure 5 for typical installation procedure.

The fresh air damper assembly is standard equipment with the unit because of the variety of state or local codes requiring fresh air capability.

All capacity, efficiency and cost of operation information as required for Department of Energy "Energyguide" Fact Sheets is based upon the fresh air blank-off plate in place and is recommended for maximum energy efficiency.

The blank-off plate is available upon request from the factory and is installed in place of the fresh air damper shipped with each unit.

WALL MOUNTING

1. Two holes, for the supply and return air openings must be cut through the wall as shown in Figure 6.
2. On wood-frame walls, the wall construction must be strong and rigid enough to carry the weight of the unit without transmitting any unit vibration. **WARNING:** Fire hazard can result if 1 inch clearance to combustible materials for supply air duct is not maintained. See Figure 6.
3. Concrete block walls must be thoroughly inspected to insure that they are capable of carrying the weight of the installing unit.
4. Ducts through the walls must be insulated and all joints taped or sealed to prevent air or moisture entering the wall cavity.
5. Some installations may not require any return air duct. It is recommended that on this type of installation that a filter grille be located in the wall. Filters must be of sufficient size to allow a maximum velocity of 400 FPM.

NOTE: If no return air duct is used, applicable installation codes may limit this cabinet to installation only in a single story structure.

WIRING--MAIN POWER

Refer to the unit rating plate for wire sizing information and maximum fuse or "HACR Type" circuit breaker size. Each outdoor unit is marked with a "Minimum Circuit Ampacity." This means that the field wiring used must be sized to carry that amount of current. Depending on the installed KW of electric heat, there may be two field power circuits required. If this is the case, the unit serial plate will so indicate. Some models are suitable only for connection with copper wire, while others can be wired with either copper or aluminum wire. Each unit and/or wiring diagram will be marked "Use Copper Conductors Only" or "Use Copper or Aluminum Conductors." These instructions **MUST BE** adhered to. Refer to the National Electrical Code for complete current carrying capacity data on the various insulation grades of wiring material.

The electrical data lists fuse and wire sizes (60 degree F copper) for all models, including the most commonly used heater sizes. Also shown are the number of field power circuits required for the various models with heaters.

Field conduit connections must be to the control box and not terminate at the cabinet.

The unit rating plate lists a "Maximum Time Delay Relay Fuse" of "HACR Type" circuit breaker that is to be used with the equipment. The correct size must be used for proper circuit protection and also to assure that there will be no nuisance tripping due to the momentary high starting current of the compressor motor.

WIRING--24V CONTROL CIRCUIT

Nine (9) wires should be run from thermostat subbase to the 24V terminal board in the unit. A nine conductor, 18 gauge copper, color-coded thermostat cable is recommended. The connection points are shown on most of the wiring diagrams and are also shown below.

FIGURE 2

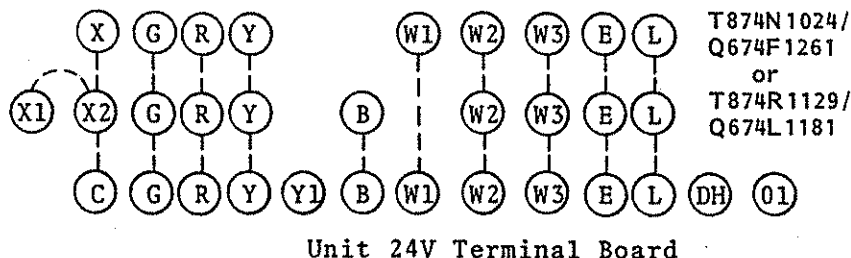

IMPORTANT NOTE: Only the thermostat and subbase combinations as shown above will work with this equipment. The stat and subbase **MUST BE** matched, and correct operation can be assured only by proper selection and application of these parts.

CONDENSATE DRAIN

A plastic drain hose extends from the drain pan at the top of the unit down to the unit base. There are openings in the unit base for the drain hose to pass through. In the event the drain hose is connected to a drain system of some type, it must be an open or vented type system to assure proper drainage.

COMPRESSOR MALFUNCTION RELAY (Single Phase Models Only)

Actuation of the green "check" lamp is accomplished by a voltage type relay which is factory installed. Any condition such as loss of charge, defective capacitor, defective contactor, etc., that will prevent compressor from operating will cause green lamp to activate. This is a signal to the operator of the equipment to place system in emergency heat position.

PRESSURE SERVICE PORTS

High and low pressure service ports are installed on all units so that the system operating pressures can be observed. Pressure curves can be found later in the manual covering all models on both cooling and heating cycles. It is imperative to match the correct pressure curve to the unit by model number.

SEQUENCE OF OPERATION

COOLING--Circuit R-Y makes at thermostat pulling in compressor contactor, starting the compressor and outdoor motor. The G (indoor motor) circuit is automatically completed on any call for cooling operation, or can be energized by manual fan switch on subbase for constant air circulation.

HEATING--A 24V solenoid coil on reversing valve controls heating cycle operation. Two thermostat options, one allowing "Auto" changeover from cycle to cycle and the other constantly energizing solenoid coil during heating season and thus eliminating pressure equalization noise except during defrost, are to be used. On "Auto" option, a circuit is completed from R-W1 and R-Y on each heating "on" cycle, energizing reversing valve solenoid and pulling in compressor contactor starting compressor and outdoor motor. R-G also make starting indoor blower motor. Heat pump heating cycle is now in operation. The second option has no "Auto" changeover position, but instead energizes the reversing valve solenoid constantly whenever the system switch on subbase is placed in "Heat" position, the "B" terminal being constantly energized from R. A thermostat demand for heat completes R-Y circuit, pulling in compressor contactor starting compressor and outdoor motor. R-G also make starting indoor blower motor.

COMPRESSOR CUT-OFF THERMOSTAT AND OUTDOOR THERMOSTATS

Heat pump compressor operation at outdoor temperatures below 0 degree F are neither desirable nor advantageous in terms of efficiency. Since most equipment at time of manufacture is not designated for any specific destination of the country, and most of the equipment is installed in areas not approaching the lower outdoor temperature range, the compressor cut-offs are not factory installed.

Outdoor thermostats are available to hold off various banks of electric heat until needed as determined by outdoor temperature. The set point of either type of thermostat is variable with geographic region and sizing of the heating equipment to the structure. Utilization of the Heating Application Data and the heat loss calculation of the building are useful in determining the correct set points.

COMPRESSOR CUT-OFF AND OUTDOOR THERMOSTAT WIRING

See specific wiring information on page 12.

HEAT ANTICIPATION

Both of the thermostats shown below have a fixed heat anticipator for stage 1 with no adjustment required. Stage 2 has an adjustable anticipator for the W2 connection and fixed for the W3 connection. Both the W2 and W3 circuits are controlled by the stage 2 bulb. The only heat anticipator that needs to be checked is stage 2 and it should be set to match the load carried by the W2 circuit. The normal factory wiring provides for only one electric heat contactor to be controlled by W2, and the anticipator should be set at .40A. If special field wiring is done, it is best to actually measure the load but a good rule is .40A for each heat contactor controlled by W2.

TABLE 2

WALL THERMOSTAT AND SUBBASE COMBINATIONS			
Group	Thermostat	Subbase	Predominant Feature
A	8403-017 (T874R1129)	8404-009 (O674L1181)	Heat or Cool (1) No Auto
B	8403-018 (T874N1024)	8404-010 (O674F1261)	Automatic Heat-Cool (2) Changeover Position

(1) No automatic changeover position--must manually place in heat or cool. Reversing valve remain energized at all times system switch is in heat position (except during defrost cycle). No pressure equalization noise when thermostat is satisfied on either heating or cooling.

(2) Allows thermostat to control both heating or cooling operation when set in "AUTO" position. Reversing valve de-energizes at end of each "ON" heating cycle.

IMPORTANT NOTE: Both thermostat and subbase combinations shown above incorporate the following features: Man-Auto fan switch, Off-Heat-Cool-Em. Heat Switch, and two (2) indicator lamps--one for emergency heat and one for compressor malfunction.

THERMOSTAT INDICATOR LAMPS

The red lamp marked "Em.HT." comes on and stays on whenever the system switch is placed in the emergency heat position. The green lamp marked "check" will come on if there is any problem that prevents the compressor from running when it is supposed to be.

EMERGENCY HEAT POSITION

The operator of the equipment must manually place the system switch in this position. This is done when there is a known problem with the indoor section, or when the green "check" lamp comes on indicating a problem.

DEFROST CYCLE

The defrost cycle is controlled by time and temperature. The 24 volt timer motor runs all the time the compressor is in operation. When the outdoor temperature is in the lower 40 degrees F temperature range or colder, the outdoor coil temperature is 32 degrees F or below. This temperature is sensed by the defrost thermostat mounted near the bottom of the outdoor coil on a return bend. The defrost thermostat closes at approximately 32 degrees F. Every 60 (or 30) minutes that the compressor is running, contacts 3 - 5 close for 7 minutes, with contacts 3 - 4 closed for the first 40 seconds of that 7 minutes. If the defrost thermostat is closed, the defrost relay energizes and places the system in defrost mode. An interlocking circuit is created with timer contacts 3 - 5 and defrost relay contacts 7 - 9 in series.

During the defrost mode, the refrigerant cycle switches back to the cooling cycle, the outdoor motor stops, electric heaters are energized, and hot gas passing through the outdoor coil melts any accumulated frost. When the temperature rises to approximately 57 degrees F, the defrost thermostat opens, de-energizing the defrost relay and returning the system to heating operation.

If some abnormal or temporary condition such as a high wind causes the heat pump to have a prolonged defrost cycle, contacts 3 - 5 of the defrost timer will open after 7 minutes and restore the system to heating operations automatically.

There are two time settings on the defrost timer--30 minutes and 60 minutes. Most models are shipped wired on the 60 minute setting for greatest operating economy. If special circumstances require a change to the shorter time, remove wire connected to terminal 5/60 and reconnect to terminal 5/30.

There is a manual advance knob located on the timer. This can be used to advance timer to contact closure point if it is desired to check out defrost cycle operation, without waiting for time to elapse.

FIGURE 3

DEFROST TIMER WIRING

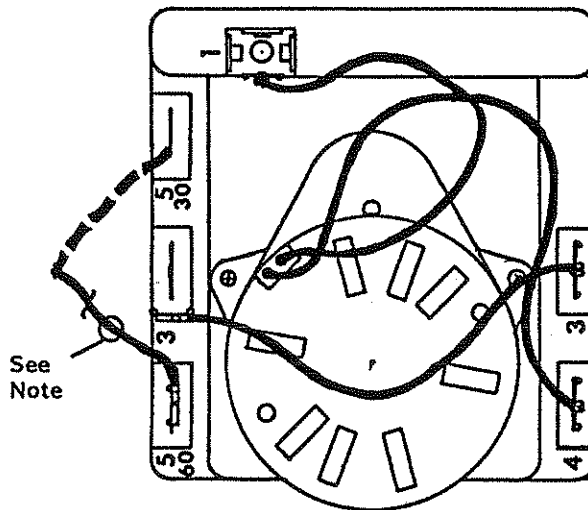

NOTE: All models are connected to 5/60 terminal (60 minute). Any model can be changed from 60 minutes to 30 minutes by unplugging from 5/60 terminal and reconnecting to 5/30 terminal as shown by dotted line.

LOW PRESSURE SWITCH

An automatic low pressure switch will open if the suction pressure drops below 10 PSIG. This switch will automatically reset at 35 PSIG and is wired in series with the compressor time delay relay. Upon a low pressure switch trip at least a 5 minute delay will occur before the compressor will restart.

COMPRESSOR TIME DELAY

The time delay relay is a time delay device which will hold off the compressor contactor for a fixed time cycle of five minutes.

The time delay relay is a solid state device designed to allow the compressor contactor to operate on demand from the wall thermostat under normal conditions. As long as the "off" time of the air conditioner or heat pump system is longer than the delay period of the relay (five minutes), the compressor contactor will operate immediately. Once the contactor has been energized and then cycled off, for whatever reason, the relay will prevent the compressor contactor from operating until the nominal five minute period has elapsed.

SERVICE HINTS

1. Caution homeowner to maintain clean air filters at all times. Also, not to needlessly close off supply and return air registers. This reduces air flow through the system, which shortens equipment service life as well as increasing operating costs.
2. Switching to heating cycle at 75 degrees F or higher outside temperature may cause a nuisance trip of the manual reset high pressure switch.
3. The heat pump wall thermostats perform multiple functions. Be sure that all function switches are correctly set for the desired operating mode before trying to diagnose any reported service problems.
4. Check all power fuses or circuit breakers to be sure that they are the correct rating.
5. Periodic cleaning of the outside coil to permit full and unrestricted airflow circulation is essential.

IMPORTANT INSTALLER NOTE

For improved start-up performance, wash the indoor coil with a dishwasher detergent.

FIGURE 4

CRANKCASE HEATERS

All units are provided with some form of compressor crankcase heat. Some single phase units utilize the compressor motor start winding in series with a portion of the run capacitor to generate heat within the compressor shell to prevent liquid refrigerant migration.

Some three phase units utilize a wraparound type of crankcase heater that warms the compressor oil from the outside.

Some single and three phase models have an insertion well-type heater located in the lower section of the compressor housing. This is a self-regulating type heater that draws only enough power to maintain the compressor at a safe temperature.

Some form of crankcase heat is essential to prevent liquid refrigerant from migrating to the compressor, causing oil pump out on compressor start-up and possible valve failure due to compressing a liquid.

Refer to unit wiring diagram to find exact type of crankcase heater used.

The decal in Figure 4 is affixed to all outdoor units detailing start-up procedure. This is very important. Please read carefully.

NOTE: If this unit is operated in cooling below a 65 degree outdoor ambient temperature, the installation of low ambient controls (LAC-1 and 8201-008 relay) to unit is required.

IMPORTANT

THESE PROCEDURES MUST BE FOLLOWED AT INITIAL START-UP AND AT ANY TIME POWER HAS BEEN REMOVED FOR 12 HOURS OR LONGER.

TO PREVENT COMPRESSOR DAMAGE WHICH MAY RESULT FROM THE PRESENCE OF LIQUID REFRIGERANT IN THE COMPRESSOR CRANKCASE

1. MAKE CERTAIN THE ROOM THERMOSTAT IS IN THE "OFF" POSITION. (THE COMPRESSOR IS NOT TO OPERATE).
2. APPLY POWER BY CLOSING THE SYSTEM DISCONNECT SWITCH. THIS ENERGIZES THE COMPRESSOR HEATER WHICH EVAPORATES THE LIQUID REFRIGERANT IN THE CRANKCASE.
3. ALLOW 4 HOURS OR 60 MINUTES PER POUND OF REFRIGERANT IN THE SYSTEM AS NOTED ON THE UNIT RATING PLATE, WHICHEVER IS GREATER.
4. AFTER PROPERLY ELAPSED TIME THE THERMOSTAT MAY BE SET TO OPERATE THE COMPRESSOR.
5. EXCEPT AS REQUIRED FOR SAFETY WHILE SERVICING — DO NOT OPEN SYSTEM DISCONNECT SWITCH.

7961-061

FIGURE 5

UNIT MODELS

20WA
24WA
18WH
24WH

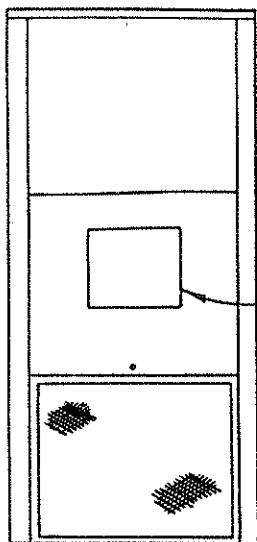

Model FAD10
Fresh Air Cover
With Adjustable
Damper

UNIT MODELS

30WA
36WA
30WH
36WH
42WA
45WH
49WA
48WH
60WA
60WH

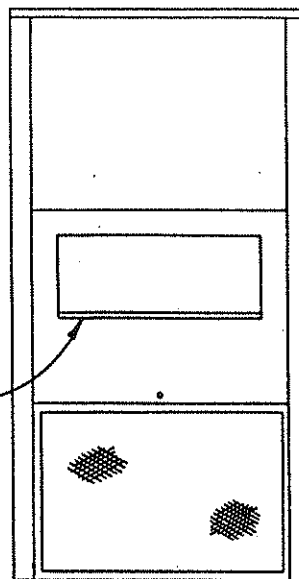

MODEL FAD25
Fresh Air Cover
With Adjustable
Damper

Service
Door

Model FAD10

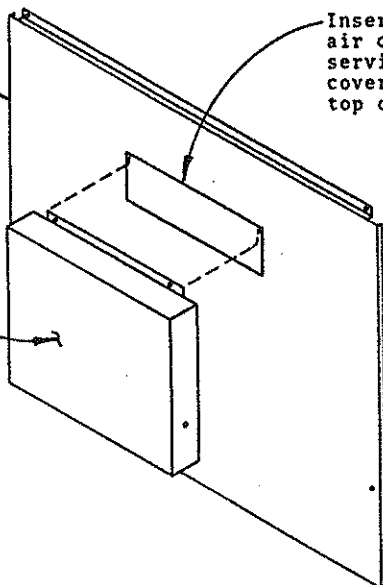

Insert top flange of fresh
air cover into opening in
service door and push top of
cover assembly all the way to
top of opening.

Service Door

Model FAD25

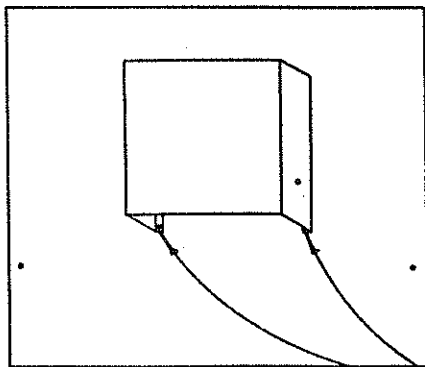
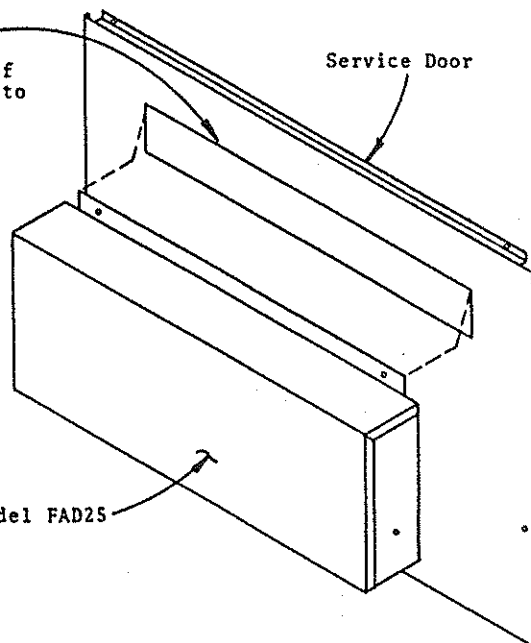

Secure bottom of
Fresh Air Cover Assembly
with two screws.

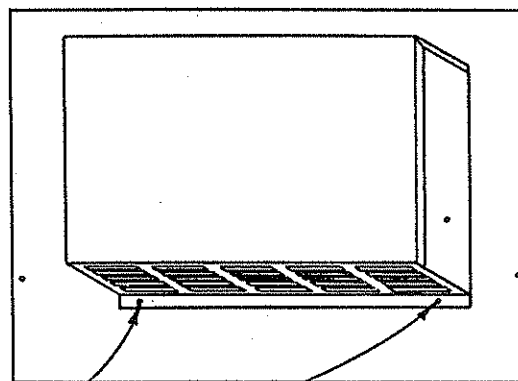
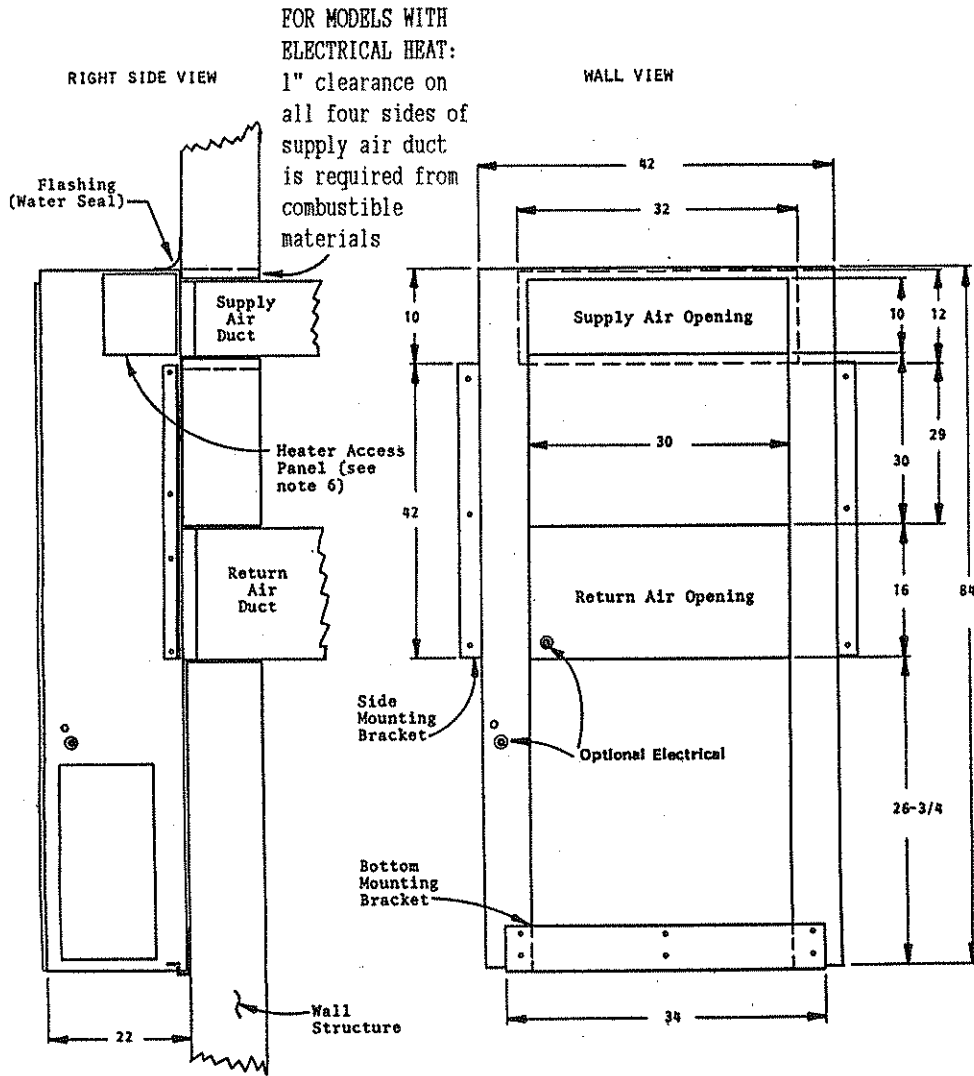

FIGURE 6



MOUNTING INSTRUCTIONS

1. These units are secured by wall mounting brackets which secure the unit to the outside wall surface at both sides and at the bottom.
2. The unit itself is suitable for "0" inch clearance. For models incorporated supplementary electric heaters, the supply air duct requires 1 inch clearance to combustible material. If combustible wall, use 32" x 12" dimensions for sizing, if non-combustible, use 30" x 10" dimensions.
3. After the wall opening positions have been selected, lay out the position for the bottom and side brackets. Fasten the brackets securely to the wall (type of fasteners will depend on wall construction).
4. Be sure to observe the 10" dimension when attaching the side brackets. This will assure that no screws are driven into the unit sides damaging any internal parts. One-half inch sheet metal screws are recommended.
5. For additional mounting rigidity, the return air and supply air (depending upon wall construction) frames or collars can be drilled and screwed or welded to the structural wall itself. Be sure to observe required clearance if combustible wall.
6. Maintain 30 inches minimum clearance on right side of unit to allow access to heat strip and control panel.

If the unit does not incorporate supplementary electric heaters, the supply air duct flange and supply duct are suitable for "0" inch clearance.

WARNING: For units with electric heaters, failure to provide the one inch clearance for the first three feet between the supply duct and a combustible surface can result in fire.

FAN BLADE SETTING DIMENSIONS

Shown in the drawing below are the correct fan blade setting dimensions for proper air delivery across the outdoor coil.

Any service work requiring removal or adjustment in the fan and/or motor area will require that the dimensions below be checked and blade adjusted in or out on the motor shaft accordingly.

FIGURE 7

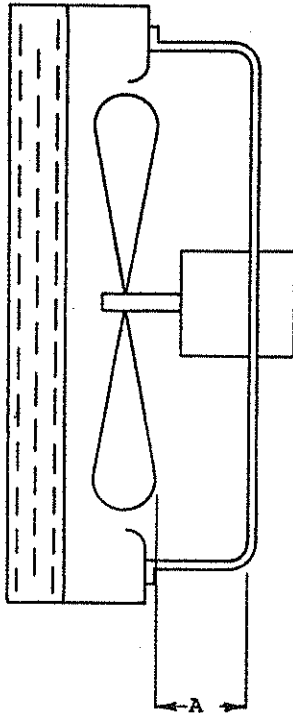

Model	Dimension A
45WH1 48WH6	2
60WH1	2

REFRIGERANT CHARGE

The correct system R-22 charge is shown on the unit rating plate. Optimum unit performance will occur with a refrigerant charge resulting in a suction line temperature (6" from compressor) as shown in the following table:

TABLE 3

Model	Rated Airflow	° 95 F OD Temperature	° 82 F OD Temperature
45WH1	1400	55 - 57	58 - 60
48WH6	1650	54 - 56	62 - 64
60WH1	1700	59 - 61	66 - 68

The above suction line temperatures are based upon 80 degrees F dry bulb/67 degrees F wet bulb (50% R.H.) temperature and rated airflow across the evaporator during cooling cycle.

TABLE 4

INDOOR BLOWER PERFORMANCE CFM--DRY COIL WITH FILTER						
E.S.P. In H ₂ O	45WH1		48WH6		60WH1	
	Low	High	Low	High	Low	High
.0	1485	1820	1450	1940	1460	2000
.1	1420	1740	1395	1865	1415	1890
.2	1355	1655	1340	1780	1375	1840
.3	--	1555	--	1690	--	1765
.4	--	1450	--	1610	--	1670
.5	--	1275	--	1510	--	1560

TABLE 5

RATED CFM AND E.S.P. (WET COIL--COOLING)			
Model	Rated *CFM	Rated *E.S.P.	Recommended Airflow Range
45WH1	1400	.25	1260 - 1540
48WH6	1650	.26	1425 - 1770
60WH1	1700	.20	1425 - 1870

*Rated CFM and E.S.P. on high speed tap.

COMPRESSOR CUT-OFF AND OUTDOOR THERMOSTAT WIRING

FIGURE 8

5,10,15Kw 1-PH — 9,12,15Kw 3-PH

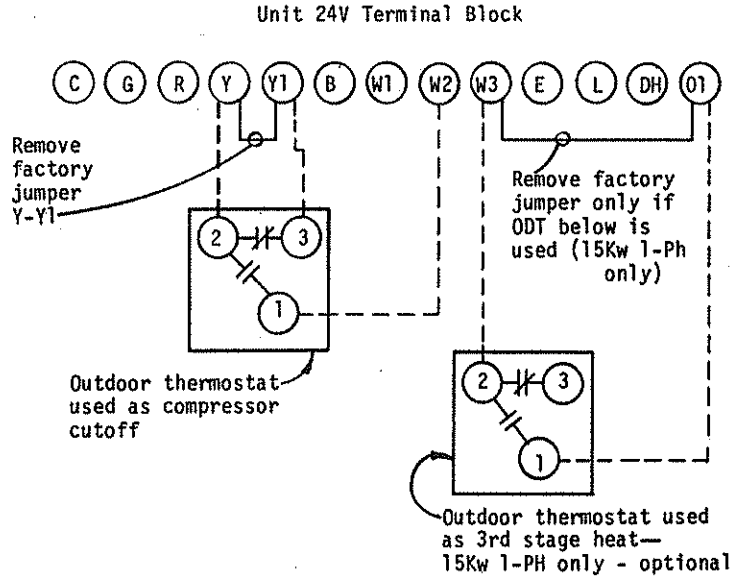

FIGURE 9

20Kw 1-PH — 18Kw 3-PH

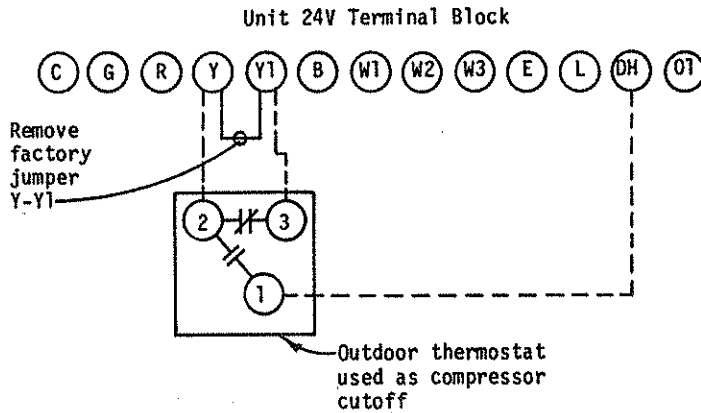

TABLE 6

COOLING

Air Temperature Entering Outdoor Coil Degree F

Model	Return Air Temperature	Pressure	°	°	°	°	°	°	°	°	°
			75	80	85	90	95	100	105	110	115
45WH1	75 deg. DB	Low Side	69	71	73	75	77	77	78	79	80
		High Side	224	235	248	261	278	285	300	309	322
	62 deg. WB	Low Side	73	76	78	80	82	83	84	85	86
		High Side	230	241	257	267	285	293	308	318	330
	85 deg. DB	Low Side	79	82	84	86	88	89	90	91	93
		High Side	236	249	265	278	295	308	319	336	349
48WH6	75 deg. DB	Low Side	70	72	74	76	77	78	79	80	81
		High Side	237	248	260	273	287	302	317	333	350
	80 deg. DB	Low Side	75	77	79	80	82	83	85	86	87
		High Side	242	254	266	280	294	309	325	341	359
	67 deg. WB	Low Side	81	83	85	86	88	90	91	93	94
		High Side	251	263	276	289	304	320	336	354	372
60WH1	75 deg. DB	Low Side	67	69	71	72	74	75	77	78	79
		High Side	240	252	265	279	293	308	324	341	359
	80 deg. DB	Low Side	72	74	76	77	79	81	82	84	85
		High Side	246	258	271	285	300	316	332	350	368
	67 deg. WB	Low Side	72	76	79	82	85	87	89	90	91
		High Side	254	267	281	296	311	327	344	362	380

TABLE 7

HEATING

Air Temperature Entering Outdoor Coil Degree F

Model	Return Air Temperature	Pressure	0	5	10	15	17	20	25	30	35	40	45	47	50	55	60
			45WH1	70 degree	Low Side	16	19	23	27	28	30	34	38	42	46	50	52
High Side	142	149			156	163	166	170	178	186	194	202	211	214	219	228	237
48WH6	70 degree	Low Side	14	18	23	27	29	32	36	39	43	46	50	51	53	56	58
		High Side	139	147	154	162	165	170	177	185	193	201	209	212	217	225	233
60WH1	70 degree	Low Side	22	24	26	29	30	32	35	38	42	46	50	52	55	60	65
		High Side	162	163	167	172	174	178	187	197	209	223	238	245	256	275	295

Low side pressure \pm 2 PSIGHigh side pressure \pm 5 PSIG

Tables are based upon rated CFM (airflow) across the evaporator coil and should be found under section titled "Refrigerant Charge" elsewhere in manual. If there is any doubt as to correct operating charge being in the system, the charge should be removed, system evacuated, and recharged to serial plate instructions.

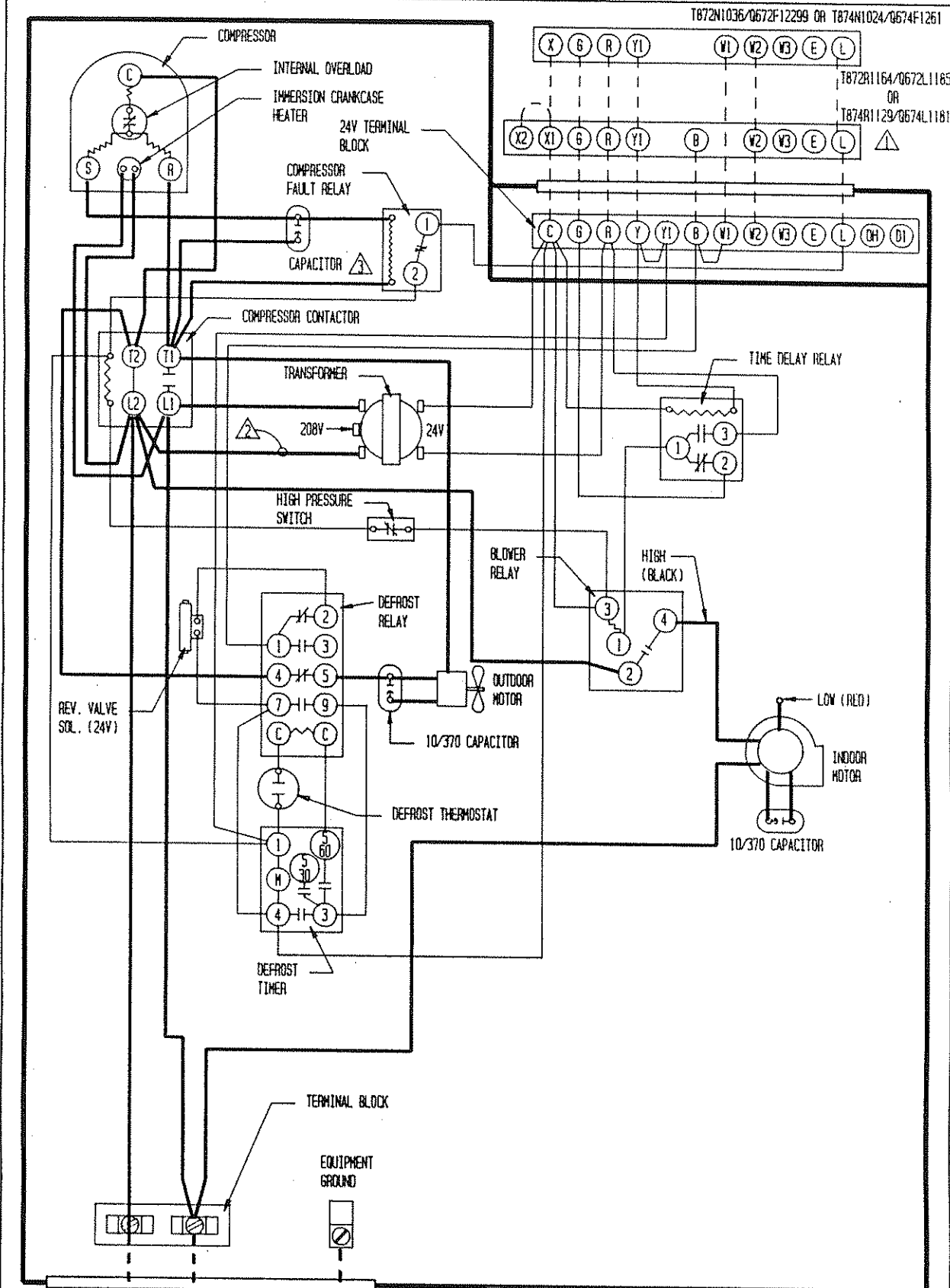

⚠ IF THERE IS AN X1 AND X2 TERMINAL ON 0674L1181, JUMPER THEM TOGETHER AND CONNECT FROM C TO EITHER ONE.

⚠ 48WH6 - 40/440 CAPACITOR
 60WH1 - 45/440 CAPACITOR

⚠ FOR 208V OPERATION MOVE THIS WIRE TO 208V TRANSFORMER TAP.

	FACTORY WIRING	FIELD WIRING	USE COPPER OR ALUMINUM WIRE
Low Voltage	—————	-----	
High Voltage	—————	-----	

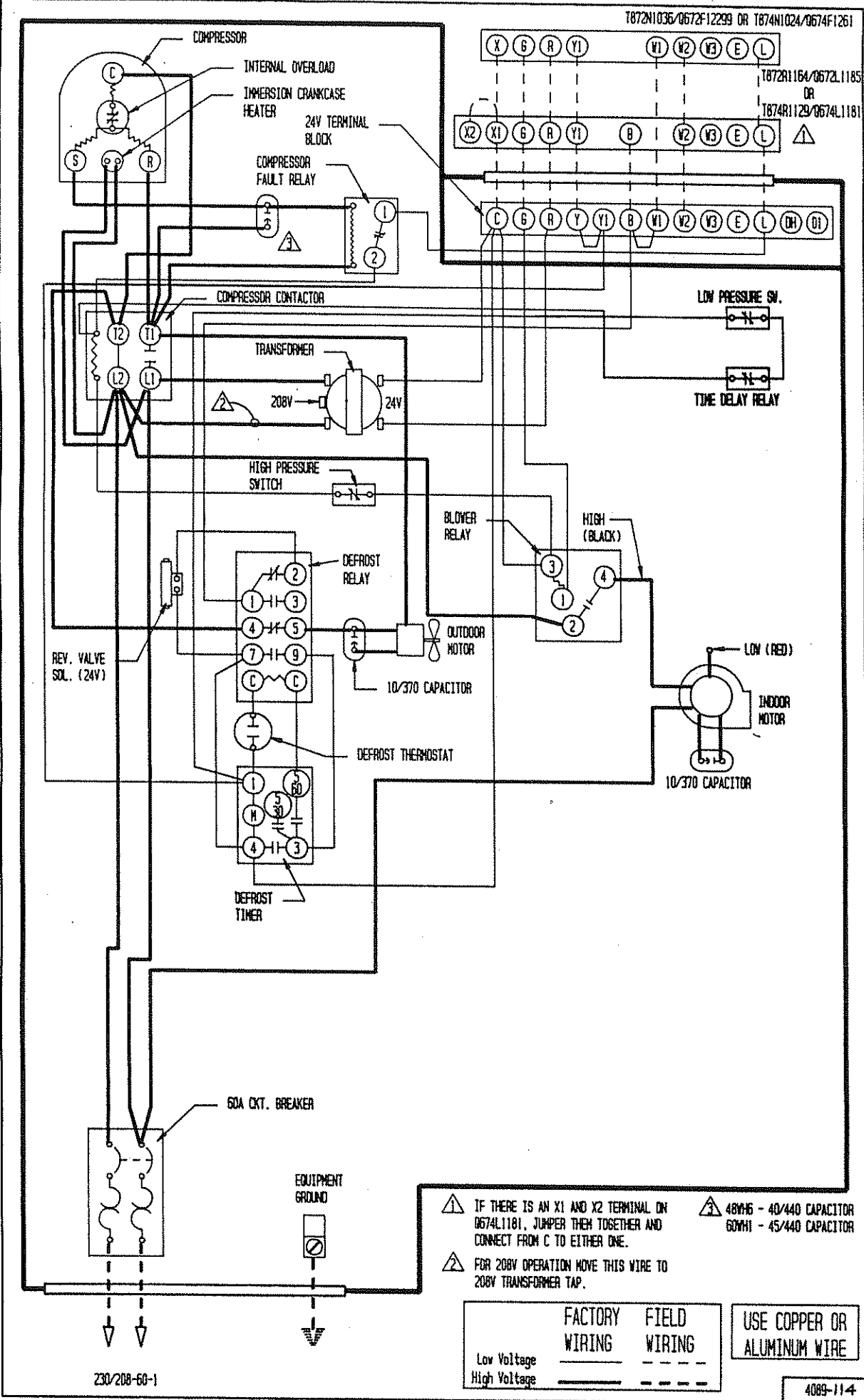

- ⚠ IF THERE IS AN X1 AND X2 TERMINAL ON 0674L1181, JUMPER THEM TOGETHER AND CONNECT FROM C TO EITHER ONE.
- ⚠ FOR 208V OPERATION MOVE THIS WIRE TO 208V TRANSFORMER TAP.
- ⚠ 48MH6 - 40/440 CAPACITOR
60MH1 - 45/440 CAPACITOR

	FACTORY WIRING	FIELD WIRING	USE COPPER OR ALUMINUM WIRE
Low Voltage	—————	- - - - -	
High Voltage	—————	- - - - -	

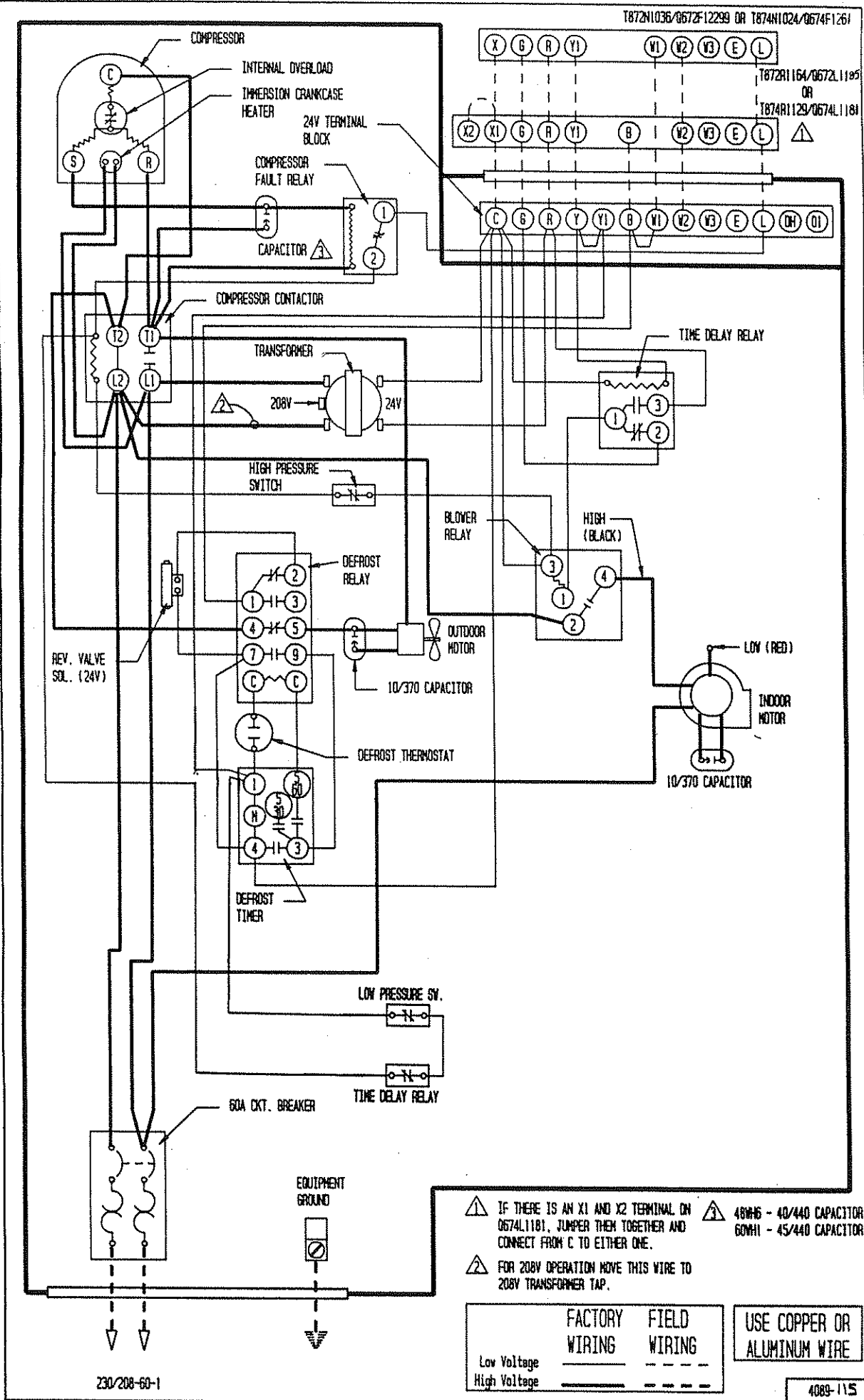

⚠ IF THERE IS AN X1 AND X2 TERMINAL ON 0674L1181, JUMPER THEM TOGETHER AND CONNECT FROM C TO EITHER ONE.

⚠ FOR 208V OPERATION MOVE THIS WIRE TO 208V TRANSFORMER TAP.

⚠ 48WH6 - 40/440 CAPACITOR
60WH1 - 45/440 CAPACITOR

	FACTORY WIRING	FIELD WIRING	USE COPPER OR ALUMINUM WIRE
Low Voltage	_____	-----	
High Voltage	_____	-----	

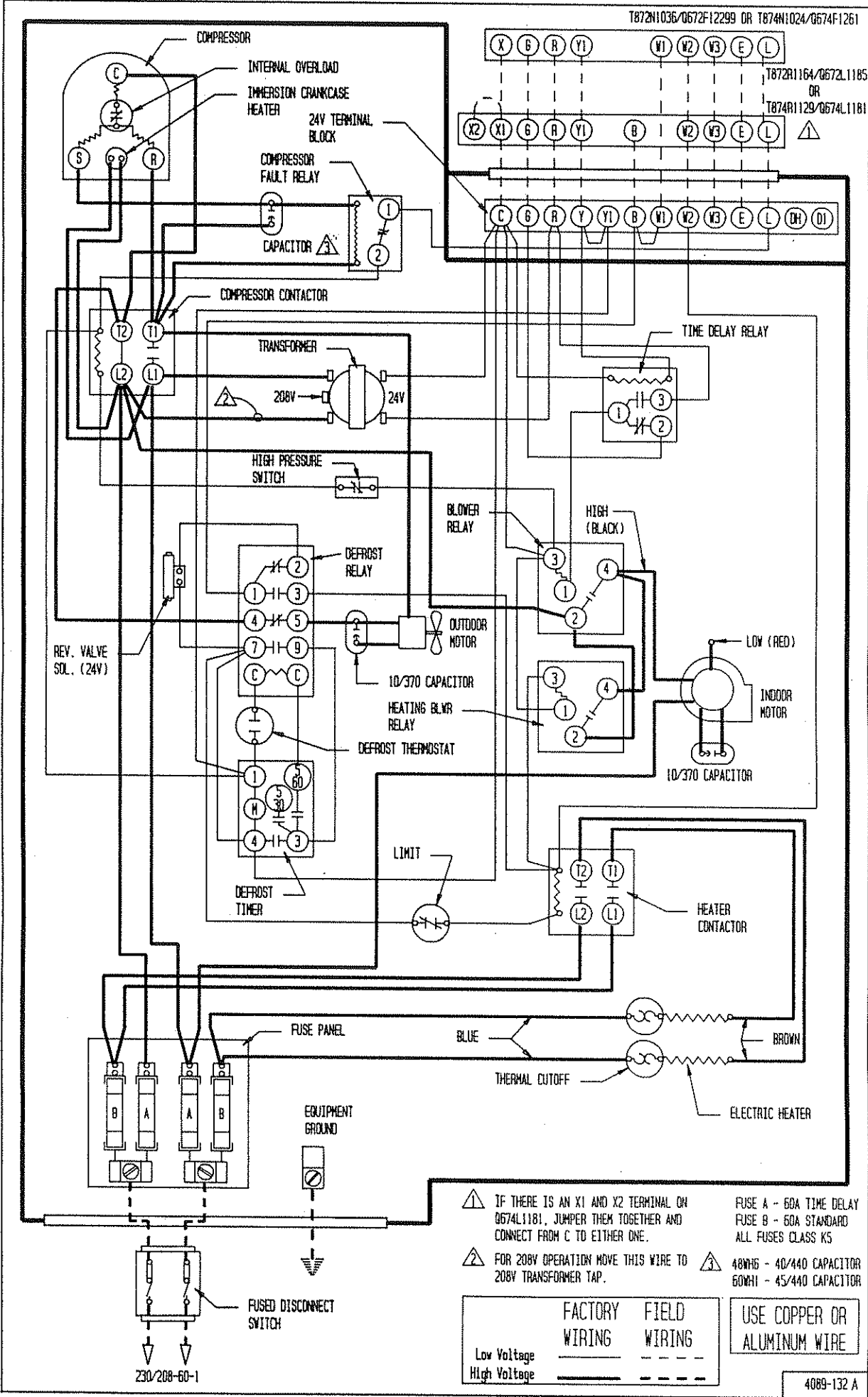

⚠ IF THERE IS AN X1 AND X2 TERMINAL ON 0674L1181, JUMPER THEM TOGETHER AND CONNECT FROM C TO EITHER ONE.
 ⚠ FOR 208V OPERATION MOVE THIS WIRE TO 208V TRANSFORMER TAP.

FUSE A - 60A TIME DELAY
 FUSE B - 50A STANDARD
 ALL FUSES CLASS KS

⚠ 48WH6 - 40/440 CAPACITOR
 60WH1 - 45/440 CAPACITOR

	FACTORY WIRING	FIELD WIRING
Low Voltage	—————	-----
High Voltage	—————	-----

USE COPPER OR ALUMINUM WIRE

4089-132 A

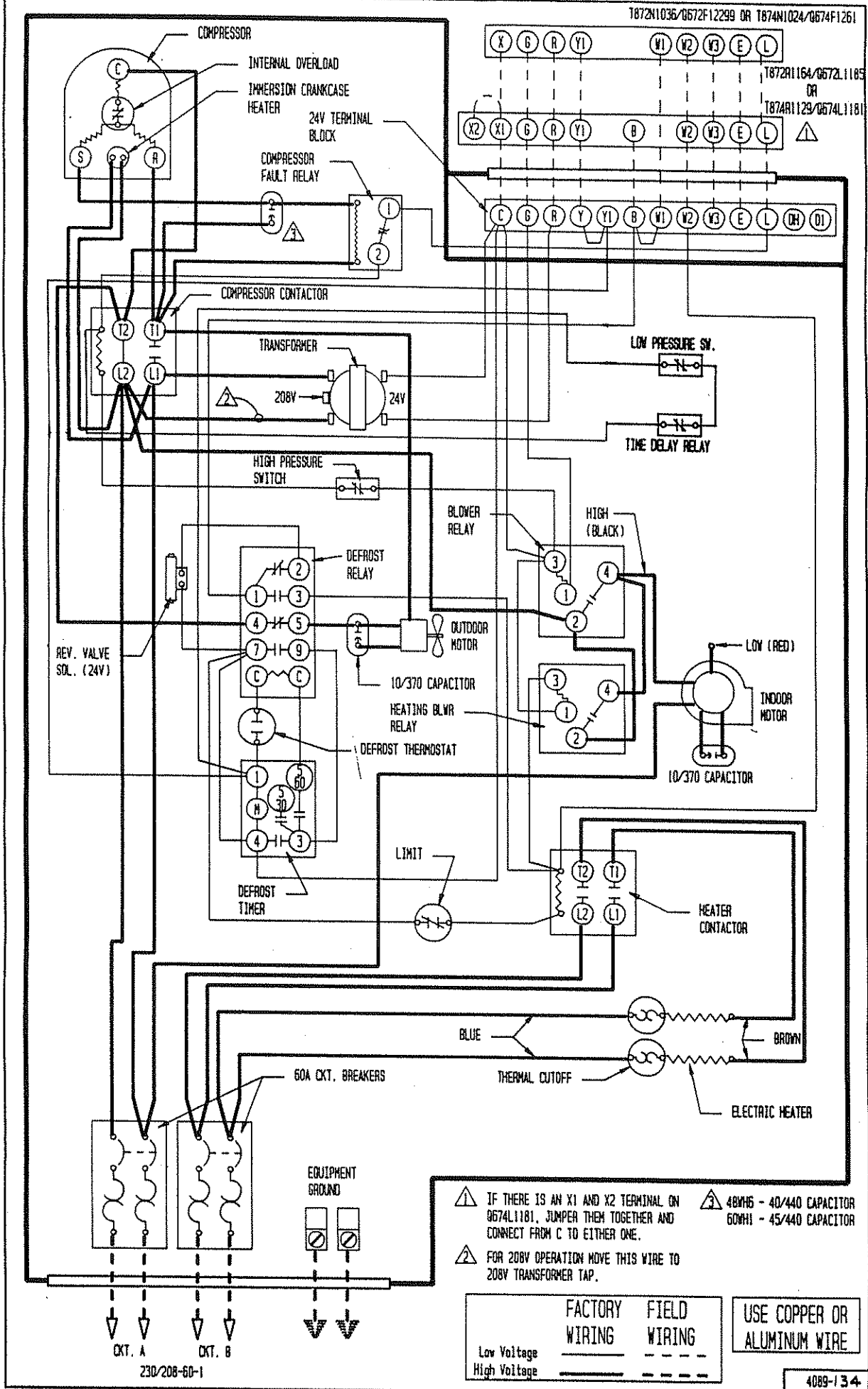

- ⚠ IF THERE IS AN X1 AND X2 TERMINAL ON 0674L1181, JUMPER THEM TOGETHER AND CONNECT FROM C TO EITHER ONE.
- ⚠ FOR 208V OPERATION MOVE THIS WIRE TO 208V TRANSFORMER TAP.
- ⚠ 48WH5 - 40/440 CAPACITOR
60WH1 - 45/440 CAPACITOR

	FACTORY WIRING	FIELD WIRING	USE COPPER OR ALUMINUM WIRE
Low Voltage	—————	- - - - -	
High Voltage	—————	- - - - -	

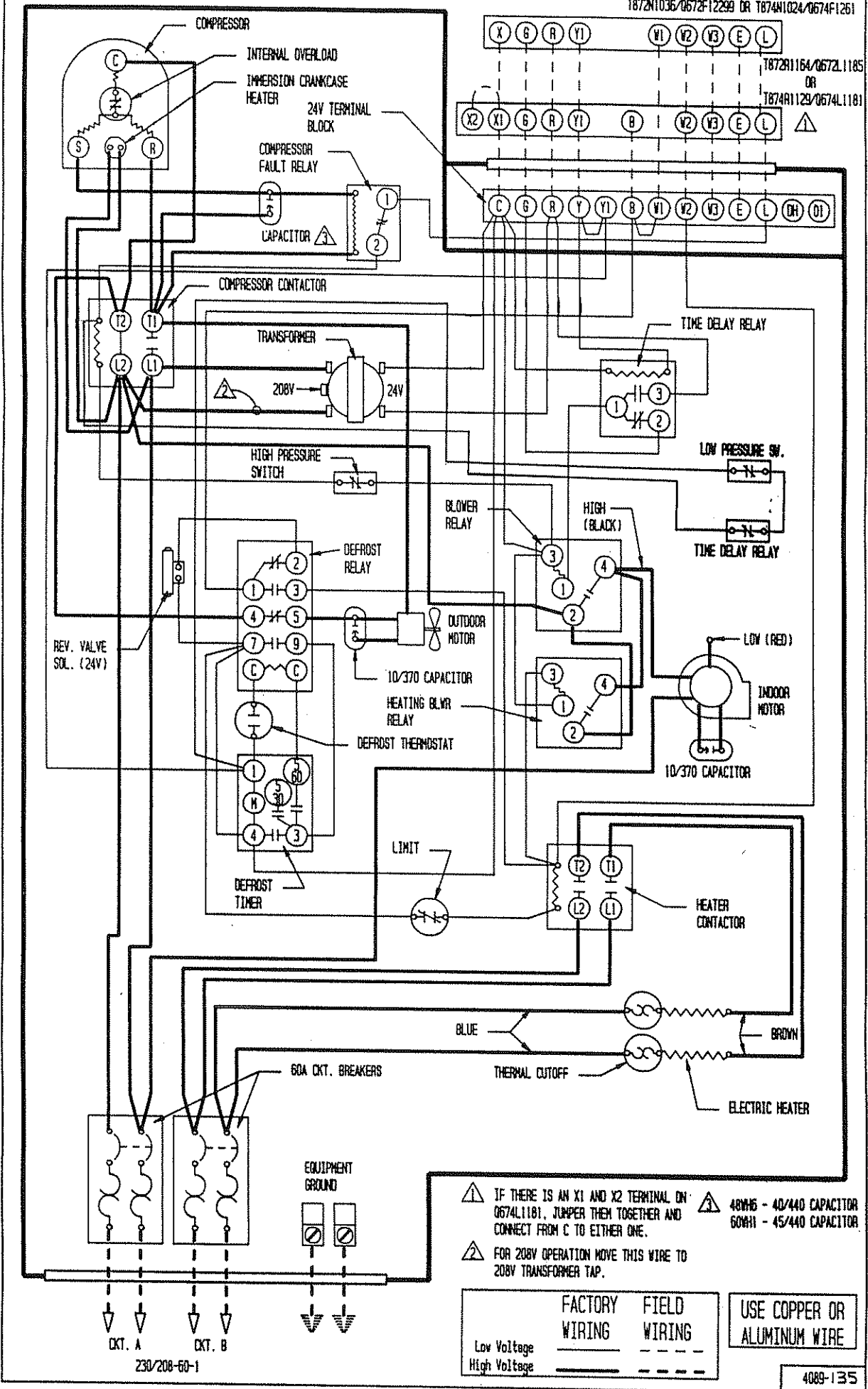

⚠ IF THERE IS AN X1 AND X2 TERMINAL ON 0674L1181, JUMPER THEM TOGETHER AND CONNECT FROM C TO EITHER ONE.

⚠ FOR 208V OPERATION MOVE THIS WIRE TO 208V TRANSFORMER TAP.

⚠ 48VMS - 40/440 CAPACITOR
 60VH1 - 45/440 CAPACITOR

	FACTORY WIRING	FIELD WIRING	USE COPPER OR ALUMINUM WIRE
Low Voltage	—————	-----	
High Voltage	—————	-----	

230/208-60-1

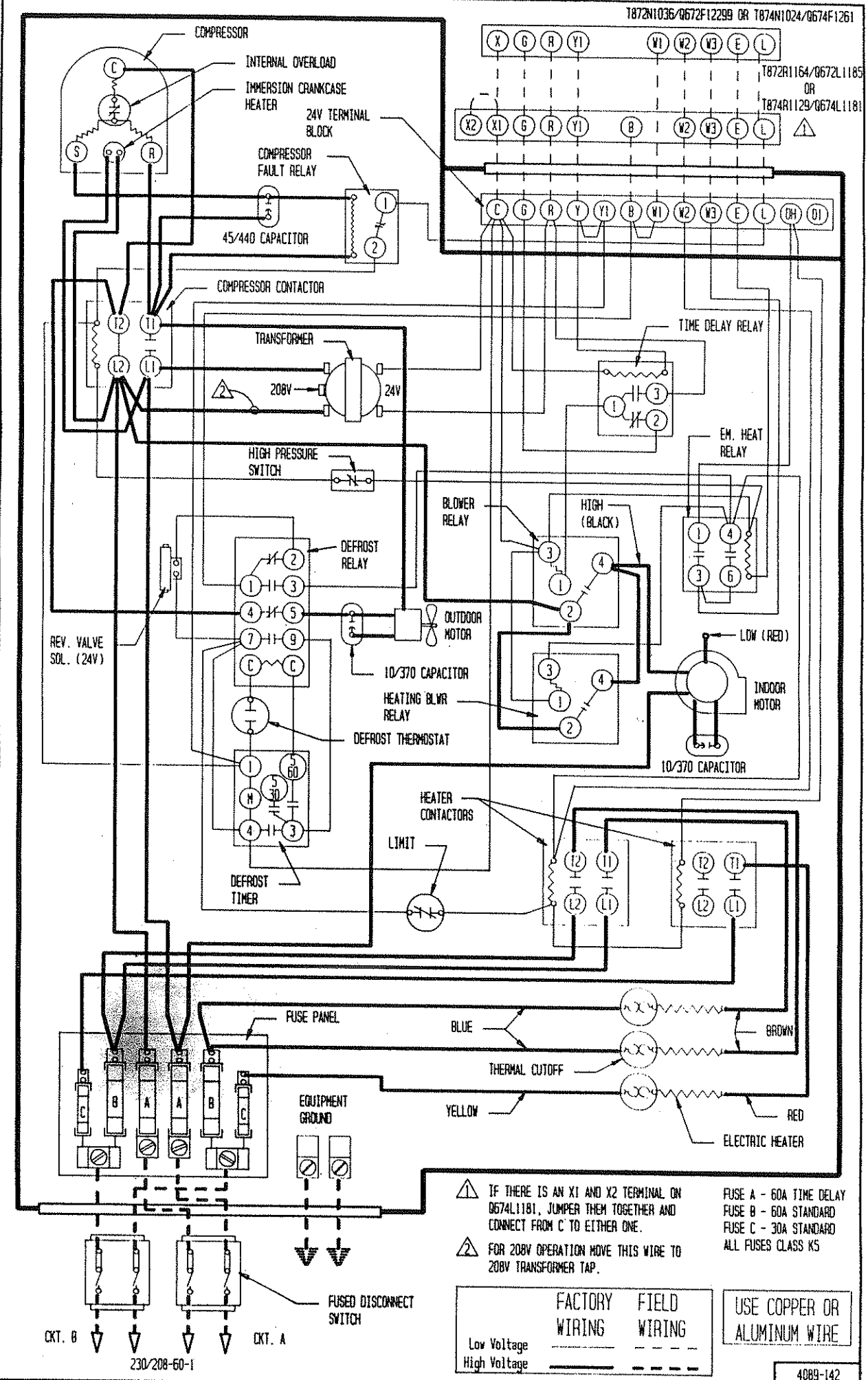

⚠ IF THERE IS AN X1 AND X2 TERMINAL ON Q674L1181, JUMPER THEM TOGETHER AND CONNECT FROM C TO EITHER ONE.

⚠ FOR 208V OPERATION MOVE THIS WIRE TO 208V TRANSFORMER TAP.

FUSE A - 60A TIME DELAY
 FUSE B - 60A STANDARD
 FUSE C - 30A STANDARD
 ALL FUSES CLASS K5

	FACTORY WIRING	FIELD WIRING	USE COPPER OR ALUMINUM WIRE
Low Voltage	—————	- - - - -	
High Voltage	—————	- - - - -	

CKT. B
 230/208-60-1
 CKT. A

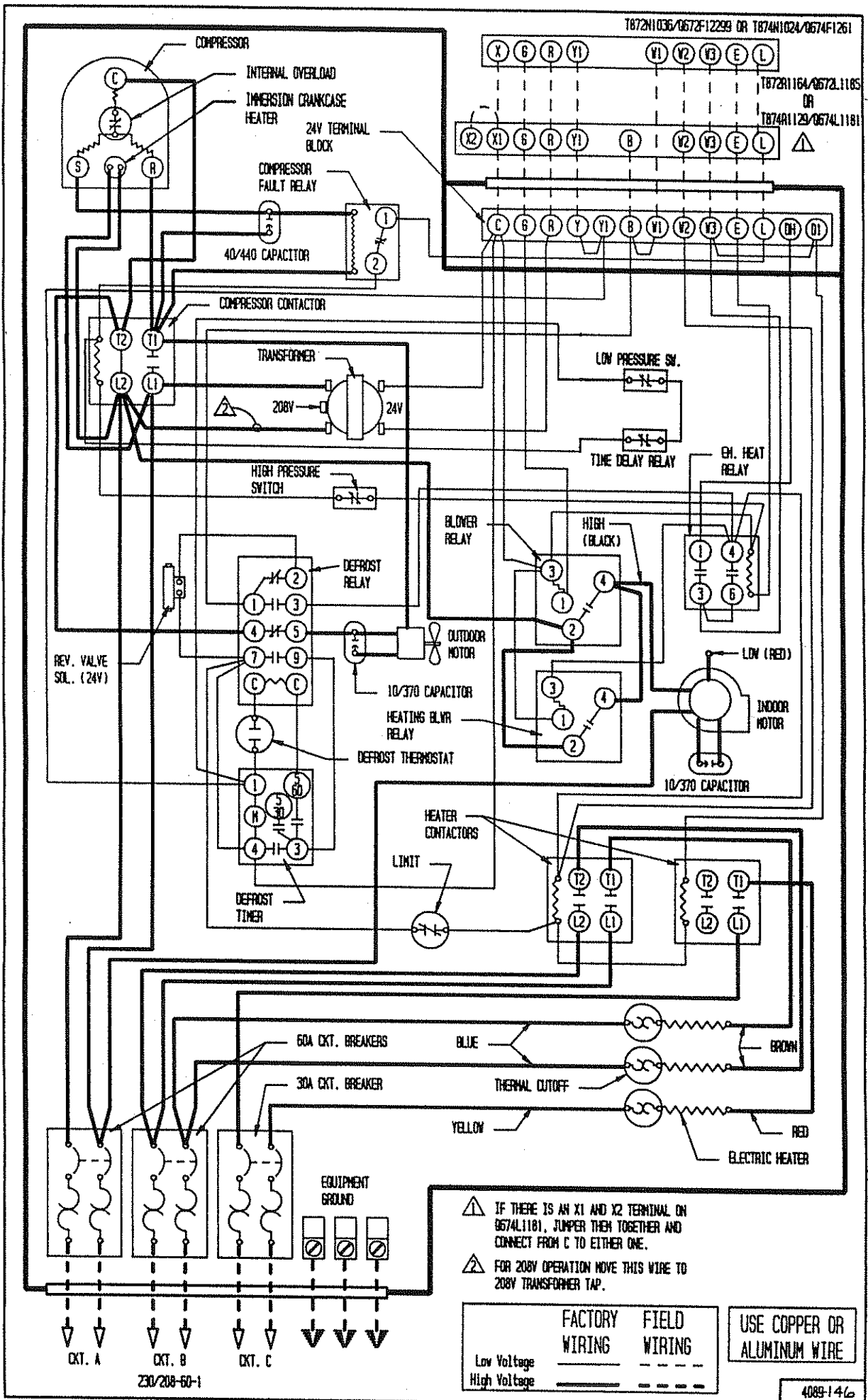

⚠ IF THERE IS AN X1 AND X2 TERMINAL ON 0674L1101, JUMPER THEM TOGETHER AND CONNECT FROM C TO EITHER ONE.

⚠ FOR 208V OPERATION MOVE THIS WIRE TO 208V TRANSFORMER TAP.

	FACTORY WIRING	FIELD WIRING
Low Voltage	—————	-----
High Voltage	-----	-----

USE COPPER OR ALUMINUM WIRE

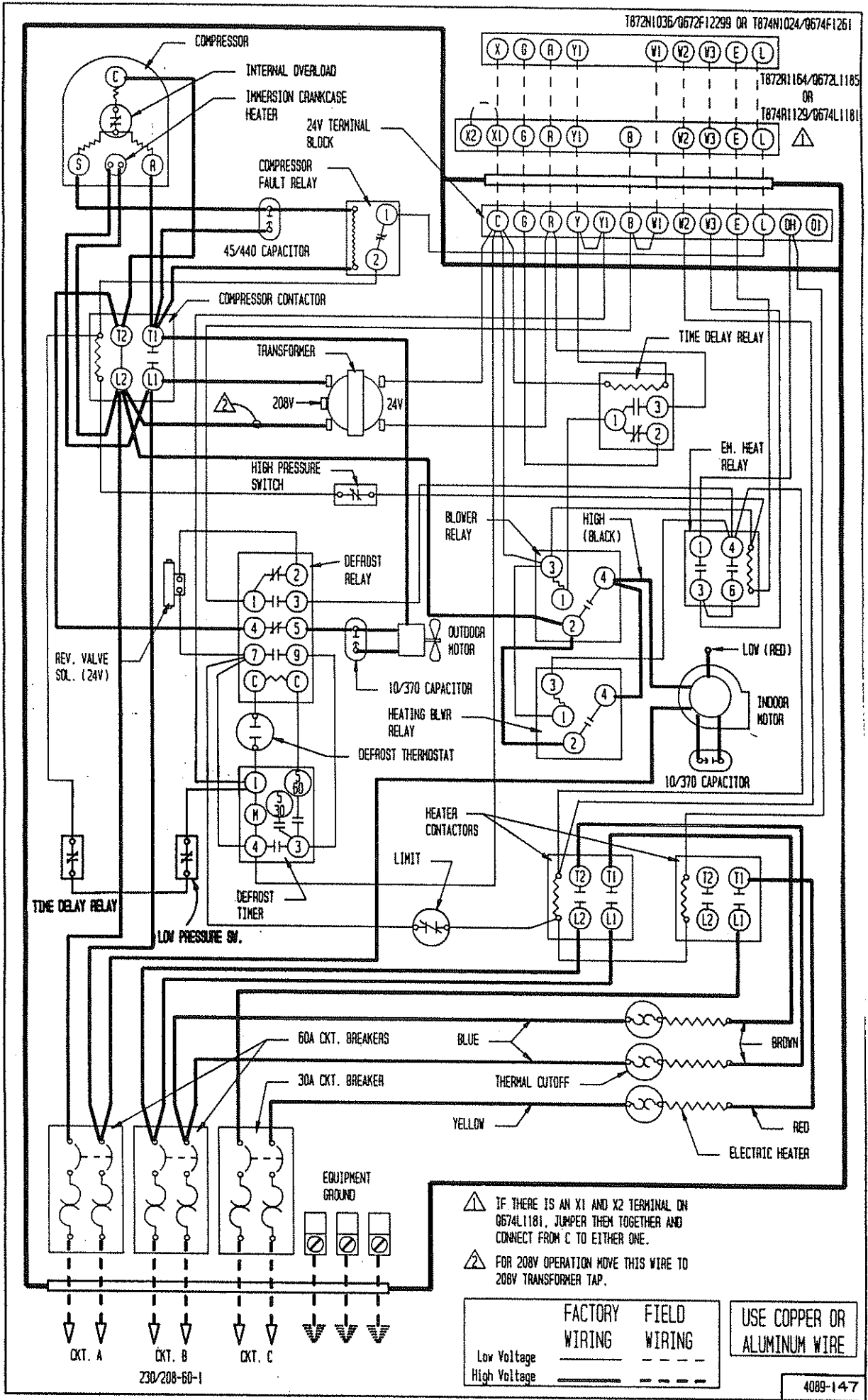

⚠ IF THERE IS AN X1 AND X2 TERMINAL ON 0674L1181, JUMPER THEM TOGETHER AND CONNECT FROM C TO EITHER ONE.

⚠ FOR 208V OPERATION MOVE THIS WIRE TO 208V TRANSFORMER TAP.

	FACTORY WIRING	FIELD WIRING
Low Voltage	—————	- - - - -
High Voltage	—————	- - - - -

USE COPPER OR ALUMINUM WIRE

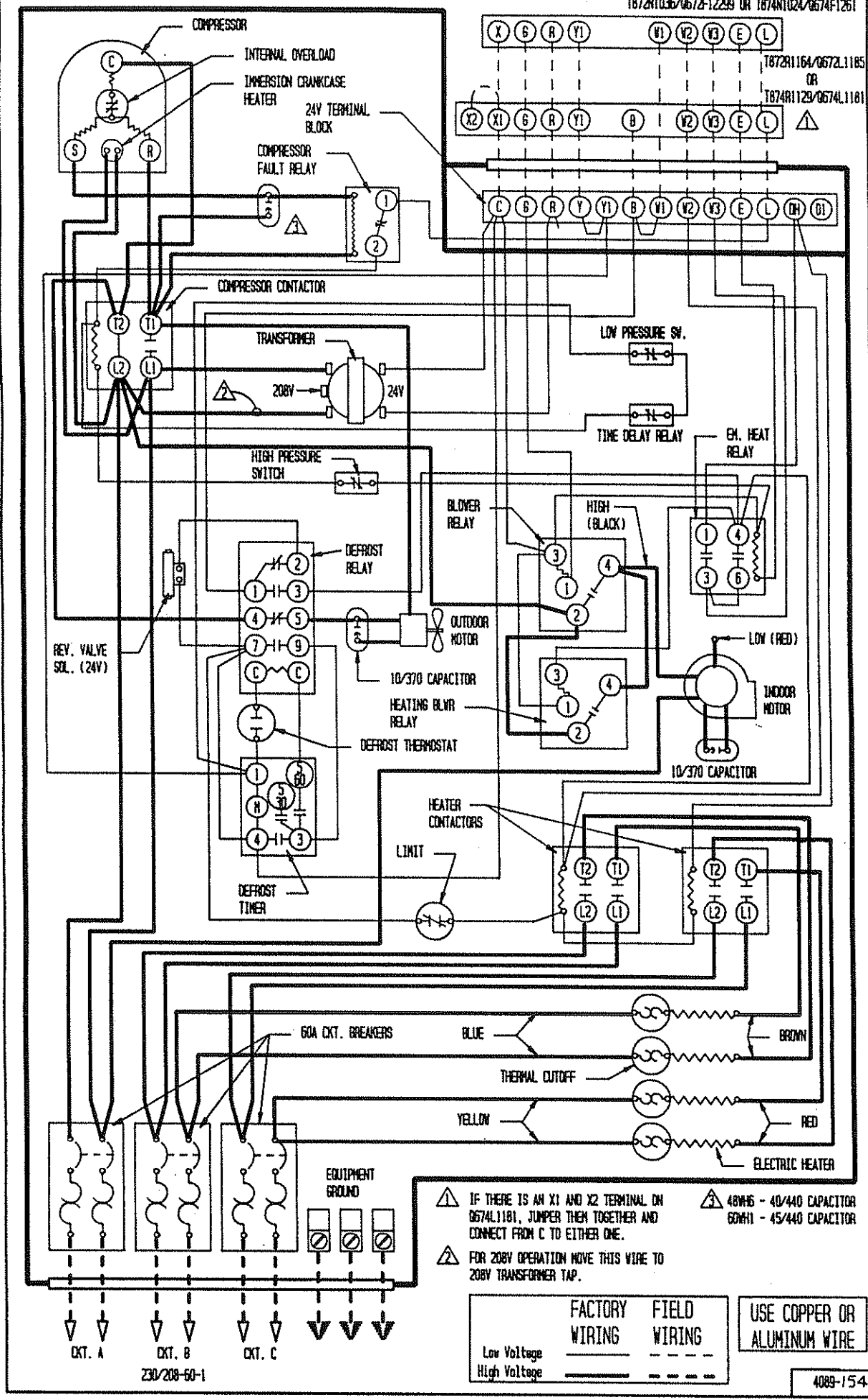

⚠ IF THERE IS AN X1 AND X2 TERMINAL ON 0674L1181, JUMPER THEM TOGETHER AND CONNECT FROM C TO EITHER ONE.

⚠ FOR 208V OPERATION MOVE THIS WIRE TO 208V TRANSFORMER TAP.

⚠ 48WH5 - 40/440 CAPACITOR
 60MH1 - 45/440 CAPACITOR

	FACTORY WIRING	FIELD WIRING
Low Voltage	—————	-----
High Voltage	—————	-----

USE COPPER OR ALUMINUM WIRE

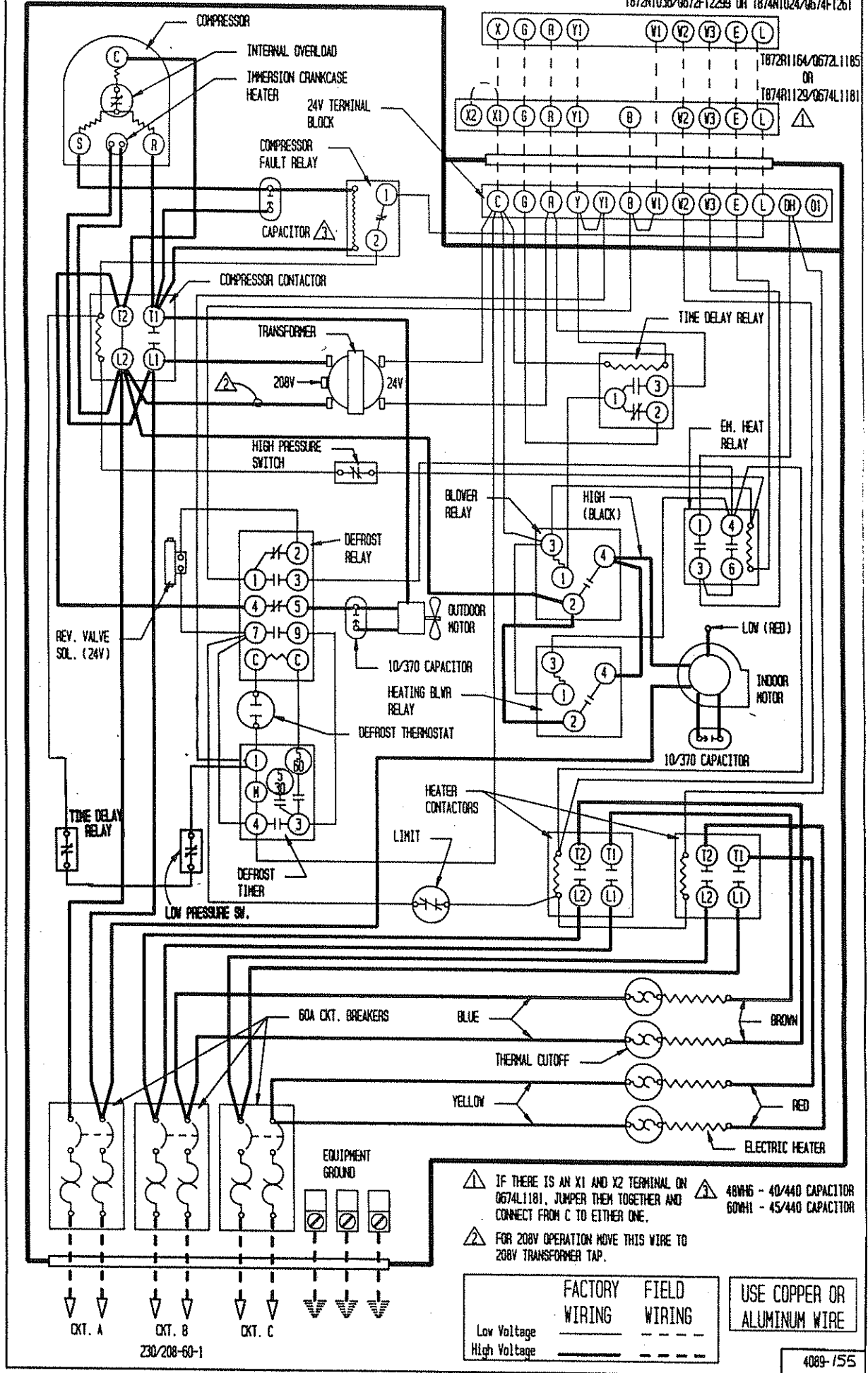

⚠ IF THERE IS AN X1 AND X2 TERMINAL ON 0674L1181, JUMPER THEM TOGETHER AND CONNECT FROM C TO EITHER ONE.

⚠ FOR 208V OPERATION MOVE THIS WIRE TO 208V TRANSFORMER TAP.

⚠ 48WH6 - 40/440 CAPACITOR
60WH1 - 45/440 CAPACITOR

	FACTORY WIRING	FIELD WIRING	USE COPPER OR ALUMINUM WIRE
Low Voltage	_____	-----	
High Voltage	_____	-----	

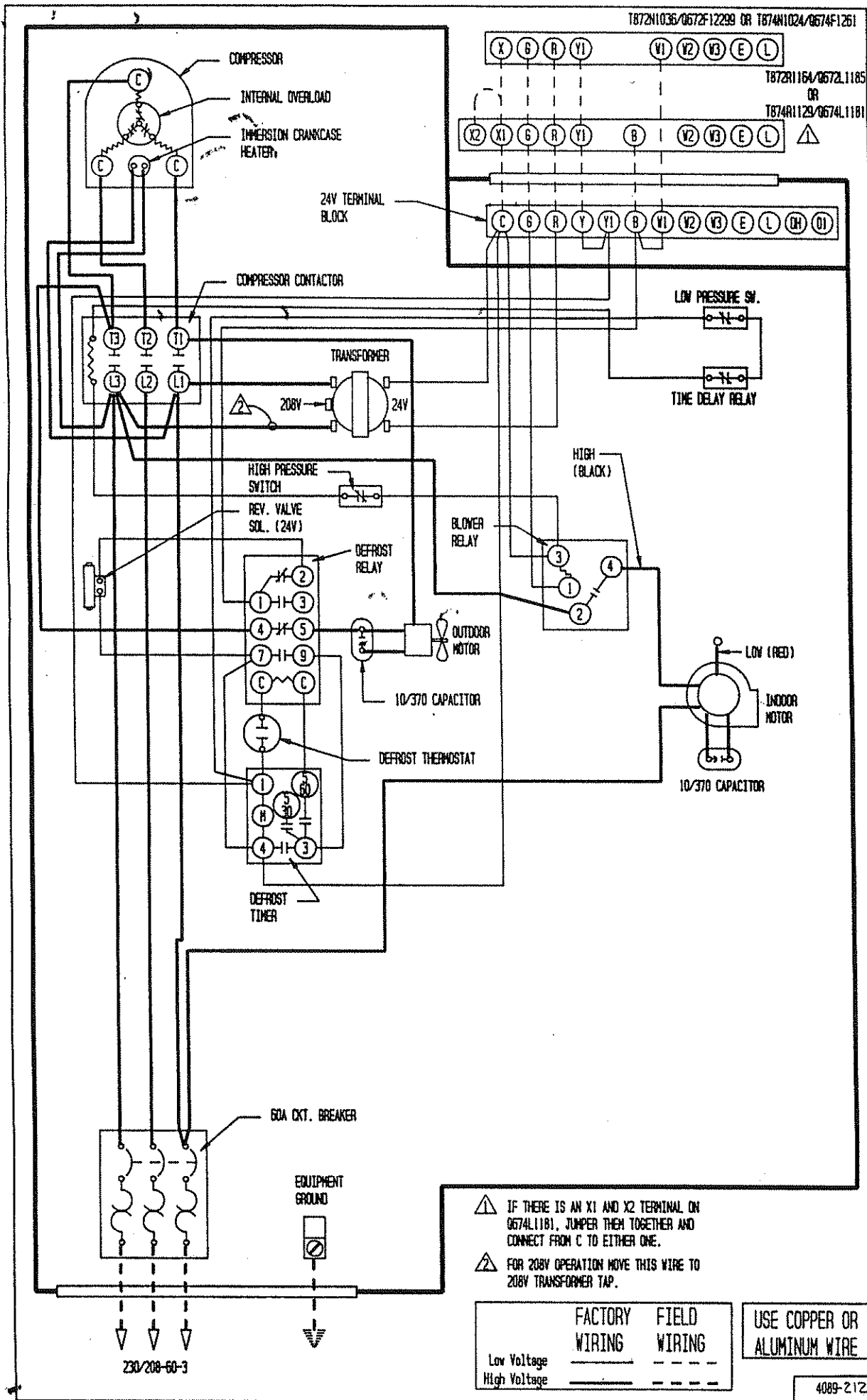

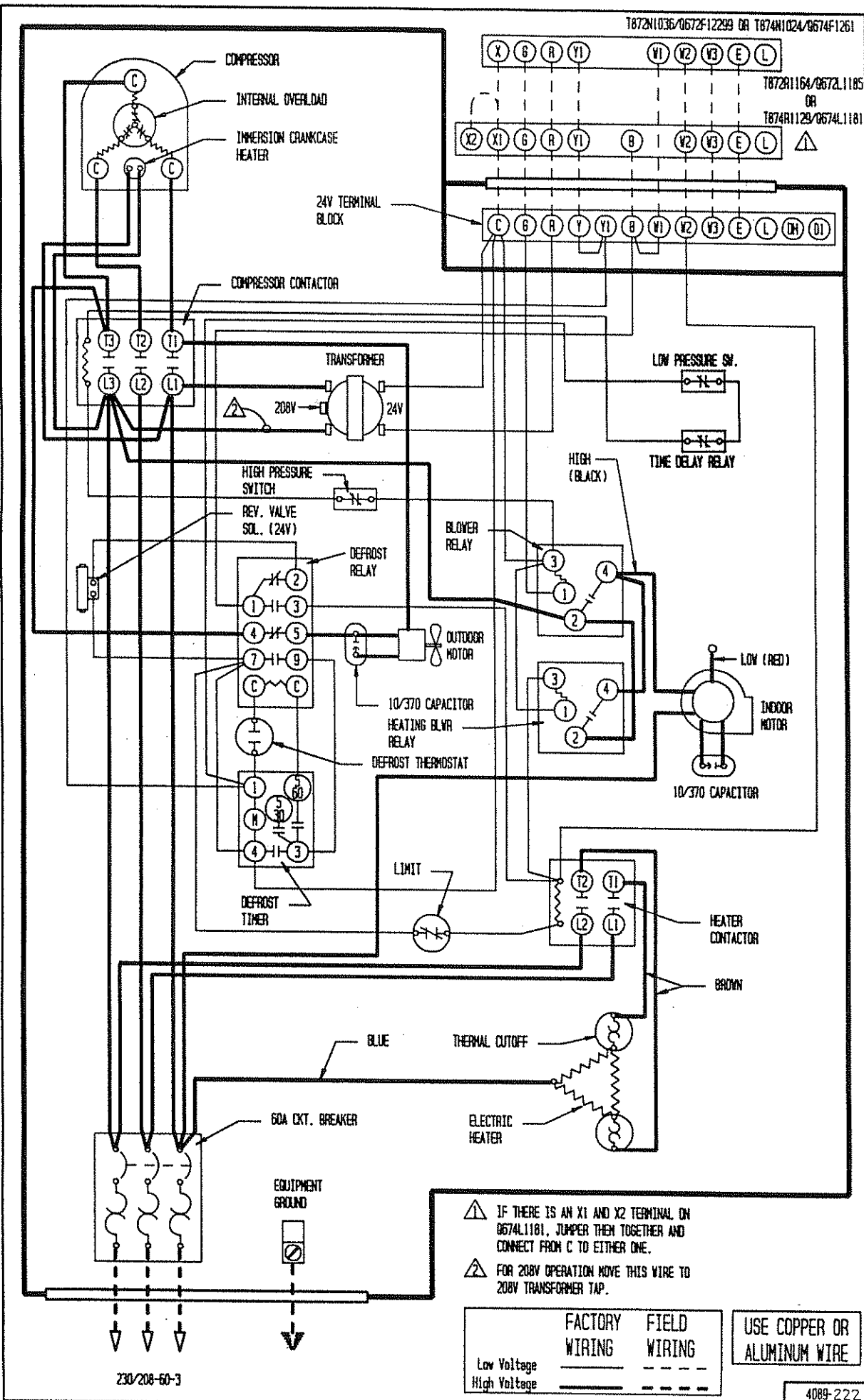

- ⚠ IF THERE IS AN X1 AND X2 TERMINAL ON 0674L1181, JUMPER THEM TOGETHER AND CONNECT FROM C TO EITHER ONE.
- ⚠ FOR 208V OPERATION MOVE THIS WIRE TO 208V TRANSFORMER TAP.

	FACTORY WIRING	FIELD WIRING	USE COPPER OR ALUMINUM WIRE
Low Voltage	—————	- - - - -	
High Voltage	—————	- - - - -	

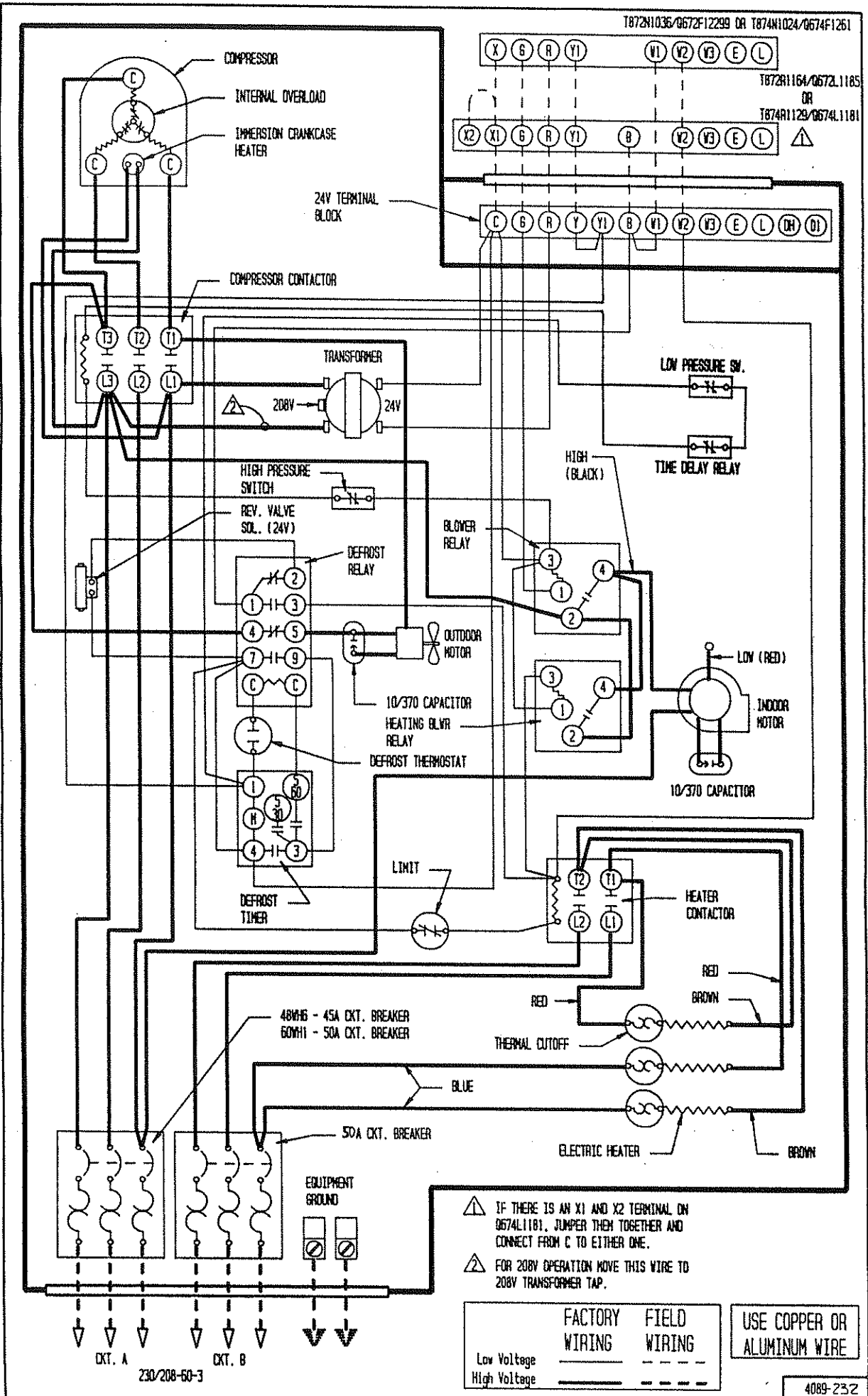

⚠ IF THERE IS AN X1 AND X2 TERMINAL ON 0674L1181, JUMPER THEM TOGETHER AND CONNECT FROM C TO EITHER ONE.

⚠ FOR 208V OPERATION MOVE THIS WIRE TO 208V TRANSFORMER TAP.

	FACTORY WIRING	FIELD WIRING
Low Voltage	—————	-----
High Voltage	—————	-----

USE COPPER OR ALUMINUM WIRE

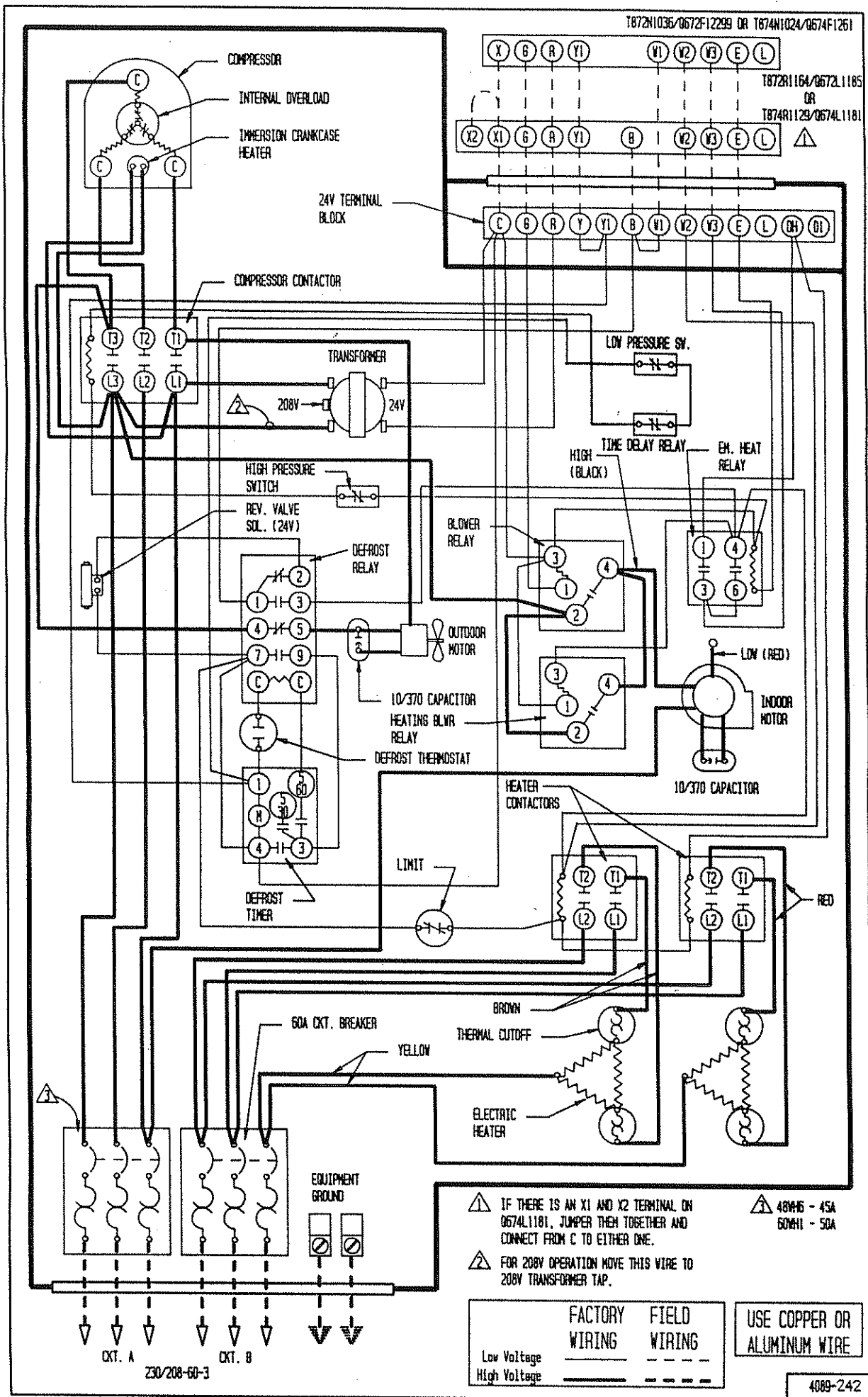

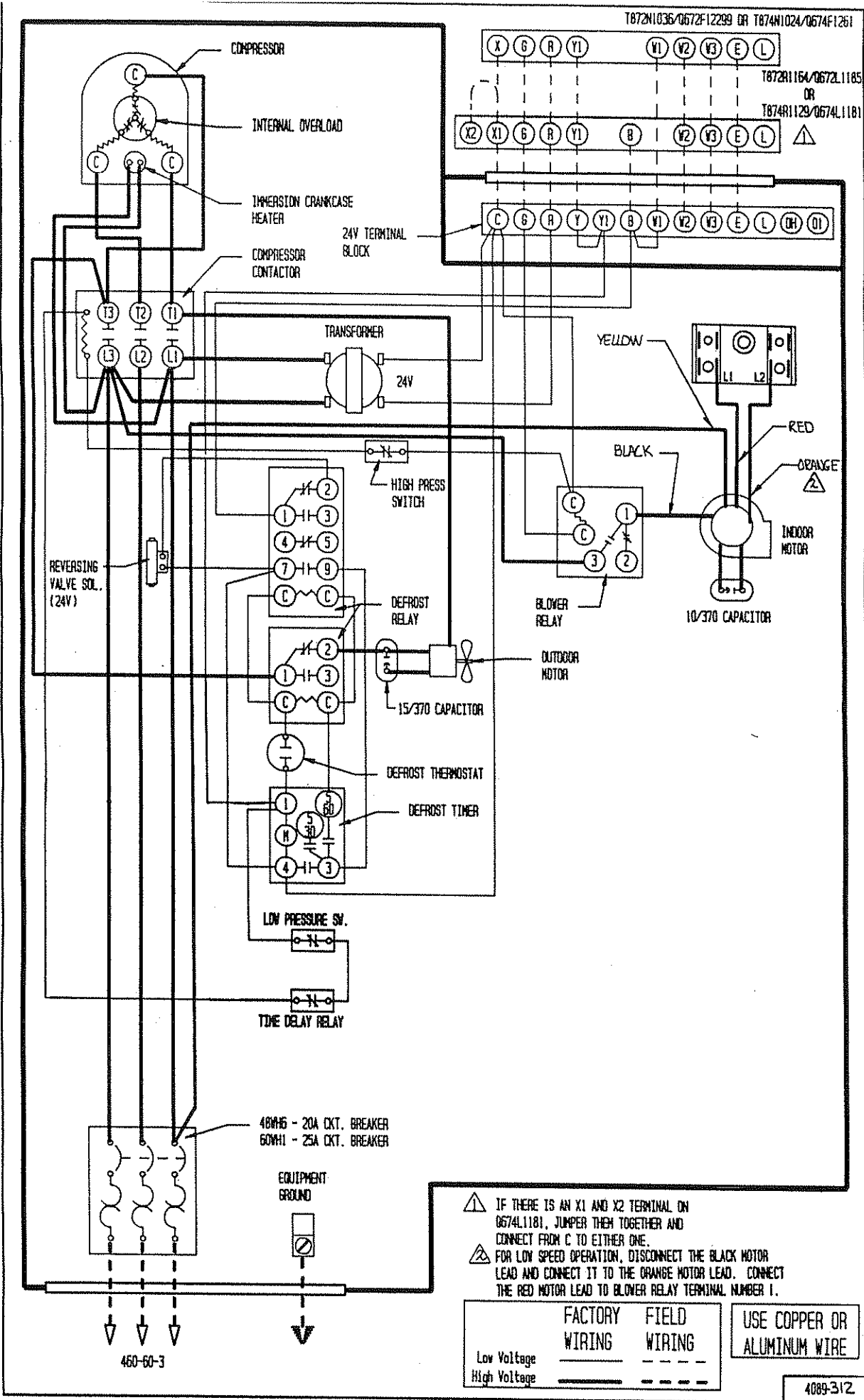

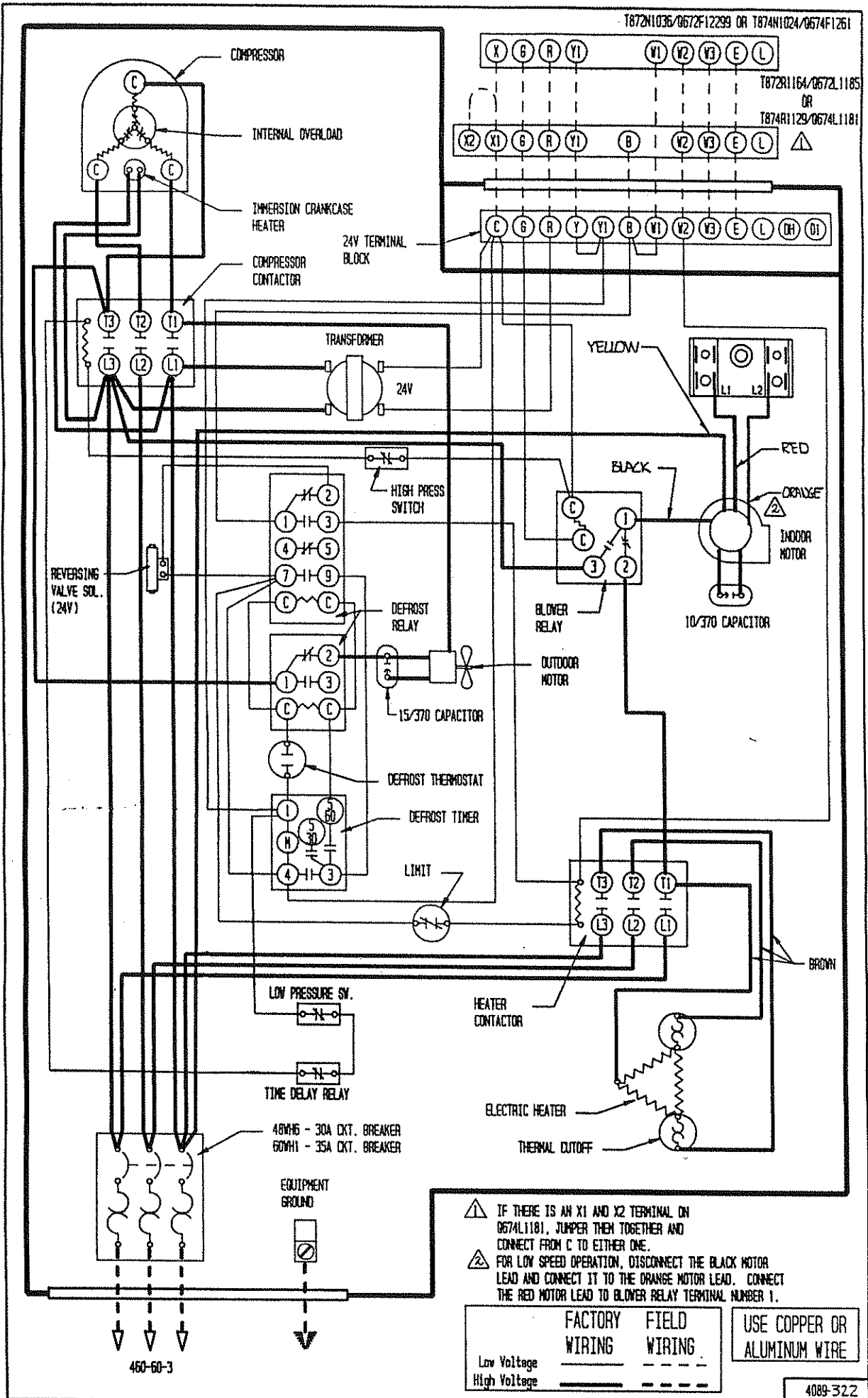

⚠ IF THERE IS AN X1 AND X2 TERMINAL ON 0574L1181, JUMPER THEM TOGETHER AND CONNECT FROM C TO EITHER ONE.
 ⚠ FOR LOW SPEED OPERATION, DISCONNECT THE BLACK MOTOR LEAD AND CONNECT IT TO THE ORANGE MOTOR LEAD. CONNECT THE RED MOTOR LEAD TO BLOWER RELAY TERMINAL NUMBER 1.

	FACTORY WIRING	FIELD WIRING	USE COPPER OR ALUMINUM WIRE
Low Voltage	—————	- - - - -	
High Voltage	—————	- - - - -	

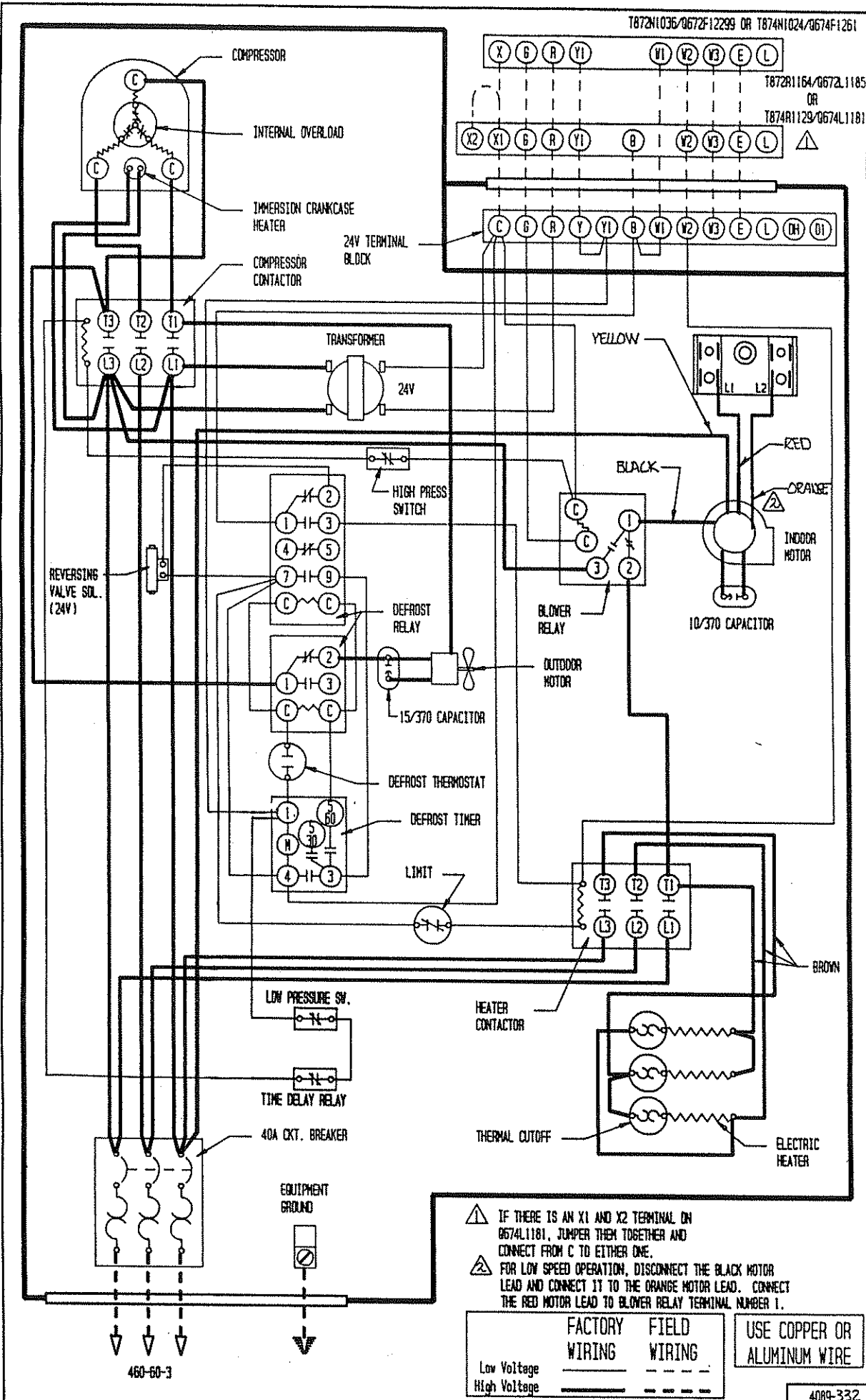

T872R1164/0672L1185
OR
T874R1129/0674L1181

- ⚠ IF THERE IS AN X1 AND X2 TERMINAL ON 0674L1181, JUMPER THEM TOGETHER AND CONNECT FROM C TO EITHER ONE.
- ⚠ FOR LOW SPEED OPERATION, DISCONNECT THE BLACK MOTOR LEAD AND CONNECT IT TO THE ORANGE MOTOR LEAD. CONNECT THE RED MOTOR LEAD TO BLOWER RELAY TERMINAL NUMBER 1.

Low Voltage High Voltage	FACTORY WIRING	FIELD WIRING	USE COPPER OR ALUMINUM WIRE
	_____	- - - - -	

460-60-3