

INSTALLATION INSTRUCTIONS

NBC35B and NBC36B

INDOOR BLOWER COIL UNIT

**FOR USE WITH
SPLIT HEAT PUMP AND
SPLIT AIR CONDITIONER SYSTEMS**

**MANUAL 2100-198 REV.
SUPERSEDES REV.**

TABLE OF CONTENTS

I.	Application and Location.	5
	General	5
	Unpacking	5
	Application	5
	Ductwork	5
	Location and Clearances	6
	Mounting Position	6
	Expansion Device	7
	Caution When Using 5780 Series Couplings	8
	Condensate Drain	9
II.	Wiring	9
	Thermostat Low-Voltage Wiring	9
	Unit Operation	10
	Air Conditioning with Electric Heat	10
	Heat Pump with Electric Heat	10
	Wall Thermostat A/C and H/P	14
	How To Set Adjustable Anticipator	15
	Additional Information For Electric Heat or Heat Pump Applications.	16
III.	Service	16
	Two Speed Blower Motor	16
	Blower Motor Oilers	16
	Filter	17
	Wiring Diagram.	18

FIGURES AND TABLES

Figure 1	1
Figure 2	6
Figure 3	7
Figure 4	8
Figure 5	15
Figure 6	16

Table 1	1
Table 2	2
Table 3	2
Table 4	3
Table 5	4
Table 6	4
Table 7	4
Table 8	4
Table 9	5
Table 10	9
Table 11	11
Table 12	11
Table 13	11
Table 14	14

Upflow - Counterflow - Horizontal
 2 Speed Direct Drive Motor
 Slide-In Return Air Filter

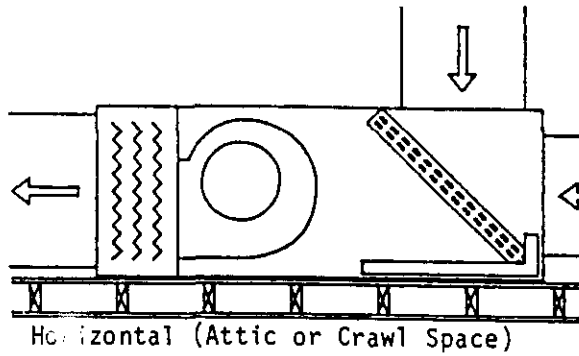
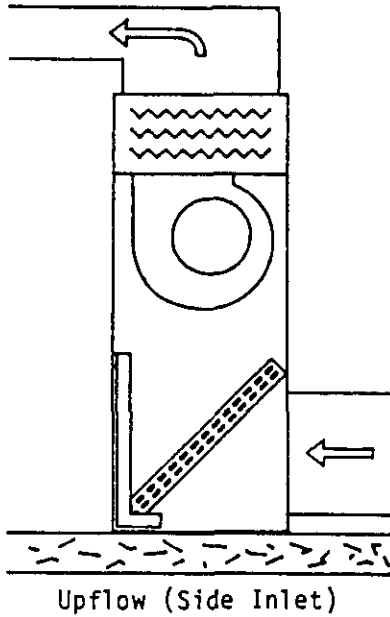
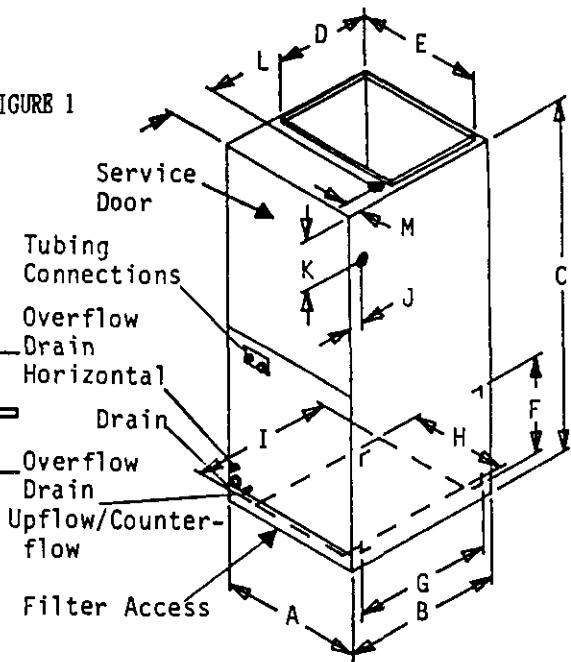
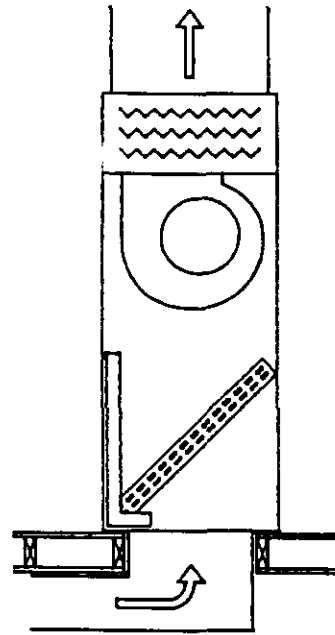

FIGURE 1



Upflow (Side Inlet)



Upflow (Bottom Inlet)

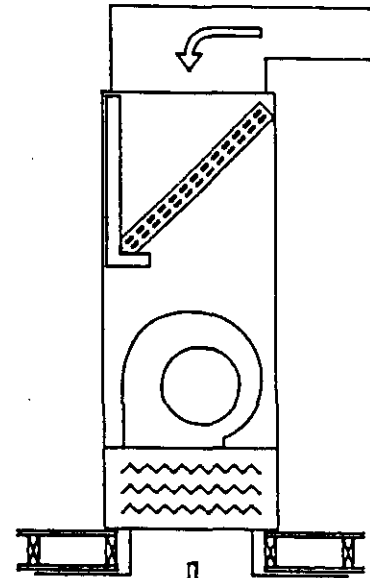

Counterflow
 Requires Combustible
 Floor Base CFB35
 A 16½ x 20½
 opening is
 required in
 the floor
 (mounting
 space).

WARNING: Failure to provide the one inch clearance for the first four feet between the supply duct and a combustible surface can result in fire.

TABLE 1

Model	Cabinet Size			Supply Outlet		Side Return Air Opening		Bottom Return Air Opening		Electrical Opening Right Side		Electrical Opening Top	
	A	B	C	D	E	F	G	H	I	J	K	L	M
NBC35B & NBC36B	20	23	51	14	18	14	20	16	19	2	7-1/4	6-11/16	2-1/4

TABLE 2

Model	NBC35B	NBC36B
Electrical Rating--60HZ	240/208V 1ph	240/208V 1ph
Operating Voltage Range	197-253	197-253
Fusing and Ampacity	See Electric Heat Table	
Blower and Motor	10x9 Direct	10x9 Direct
Motor--RPM/Speed	1075/2 Speed	1075/2 Speed
Motor--HP/AMPS	1/3 / 2.1	1/3 / 2.1
Evaporator Face Area		
Sq. Ft./Row/Fins Per Inch	3/3/14	3.12/3/10
Filter--Perm. or Throwaway	16x20x1 T	16x20x1 T
Refrigerant Cont./R22 Charge	Capillary Tube	Changeable Orifice
Maximum Electric Heat	18KW	18KW

TABLE 3
OPTIONAL FIELD-INSTALLED ELECTRIC HEATER TABLE

Heater Package Model No.	Heater Package Volts/Phase	Heater KW + Capacity @240 Volts		Heater KW + Capacity @208 Volts		Heater Amps @240/208 Volts	Max. Fuse Size (3)	Maximum Circuit Breaker (3)	Minimum Circuit Ampacity (3)	Field Wire Size (4)	Ground Wire Size (5)
		KW	BTU	KW	BTU						
None	---	---	---	---	---	---	15	HACR Type 15	15	14	14
EH3BA-A05N,C	240/208-1	4.5	15345	3.38	11525	18.8/16.3	30	HACR Type 30	28.1	10	10
EH3BA-A09N,C	240/208-1	9	30690	6.75	23018	37.5/32.5	50	HACR Type 50	50	6	10
EH3BA-A14N,C	240/208-1	13.5	46035	10.13	34543	56.3/48.7	80	80	74.9	3	8
EH3BA-A18N,C	240/208-1	18	61380	13.5	46035	75/64.9	100	100	98.3	1	8

(3) Includes blower motor

(4) Suggested size based on use of 60 degree C wiring material for ampacities less than 100A.

(5) Based upon table 250-95 degree F 1987 N.E.C.

NOTE: 9kw is the maximum electric heat approved for 50HZ applications.

TABLE 4
 MAXIMUM E.S.P. OPERATION INFORMATION (1) NBC35B, NBC36B

Type Of Application	(2)					
	Upflow Blower Speed		Counterflow Blower Speed		Horizontal Blower Speed	
	Low	High	Low	High	Low	High
Heat Pump w/18KW	.30	.45	(3)	(3)	.20	.40
Heat Pump w/14KW	.40	.55	(3)	(3)	.35	.50
Heat Pump w/9KW	.60	.60	.40	.50	.50	.55
Heat Pump w/5KW	.60	.60	.60	.60	.55	.60
Heat Pump Only	.60	.60	.60	.60	.60	.60
18KW Only	.60	.60	.60	.60	.60	.60
14KW Only	.60	.60	.60	.60	.60	.60
9KW Only	.60	.60	.60	.60	.60	.60
5KW Only	.60	.60	.60	.60	.60	.60

(1) Values shown are for bottom and side return air opening.

(2) Side inlet not available on counterflow applications.

(3) 18KW and 14KW not approved in counterflow position when used with heat pump heating.

NOTE: 9kw is the maximum electric heat approved for 50 HZ applications.

INDOOR BLOWER COIL PERFORMANCE (DRY COIL @ 230 VOLTS 60 HZ (3)) (1)

TABLE 5

Model	KW	Speed	Position	IN H2O						
				.00	.10	.20	.30	.40	.50	.60
NBC35B	0	Hi	Upflow/horizontal	1400	1355	1292	1229	1163	1093	942
NBC35B	0	Low	Upflow/horizontal	1213	1180	1141	1090	1037	956	760
NBC35B	5	Hi	Upflow/horizontal	1385	1340	1277	1214	1148	1078	927
NBC35B	5	Low	Upflow/horizontal	1198	1165	1126	1075	1022	941	745
NBC35B	9	Hi	Upflow/horizontal	1370	1325	1262	1199	1133	1063	912
NBC35B	9	Low	Upflow/horizontal	1183	1150	1111	1060	1007	926	730
NBC35B	14	Hi	Upflow/horizontal	1355	1310	1247	1184	1118	1048	897
NBC35B	14	Low	Upflow/horizontal	1168	1135	1096	1045	992	911	715
NBC35B	18	Hi	Upflow/horizontal	1340	1295	1232	1169	1103	1033	882
NBC35B	18	Low	Upflow/horizontal	1153	1120	1081	1030	977	896	700

INDOOR BLOWER COIL PERFORMANCE (DRY COIL @230 VOLTS 60 HZ (3)) (2)

TABLE 6

Model	KW	Speed	Position	IN H2O						
				.00	.10	.20	.30	.40	.50	.60
NBC35B	0	Hi	Counterflow	1360	1290	1223	1152	1092	922	743
NBC35B	0	Low	Counterflow	1216	1159	1109	1052	933	772	652
NBC35B	5	Hi	Counterflow	1345	1275	1208	1137	1077	907	728
NBC35B	5	Low	Counterflow	1201	1144	1094	1037	918	757	637
NBC35B	9	Hi	Counterflow	1330	1260	1199	1122	1062	892	713
NBC35B	9	Low	Counterflow	1186	1129	1079	1022	903	742	622
NBC35B	14	Hi	Counterflow	1315	1245	1178	1107	1047	877	698
NBC35B	14	Low	Counterflow	1171	1114	1064	1007	888	727	607
NBC35B	18	Hi	Counterflow	1300	1230	1163	1092	1032	862	683
NBC35B	18	Low	Counterflow	1156	1099	1049	992	873	712	592

INDOOR BLOWER COIL PERFORMANCE (DRY COIL @ 230 VOLTS 60 HZ (3)) (1)

TABLE 7

Model	KW	Speed	Position	IN H2O						
				.00	.10	.20	.30	.40	.50	.60
NBC36B	0	Hi	Upflow/horizontal	1348	1297	1230	1174	1110	1009	883
NBC36B	0	Low	Upflow/horizontal	1169	1135	1090	1042	987	853	707
NBC36B	5	Hi	Upflow/horizontal	1333	1282	1215	1159	1095	994	868
NBC36B	5	Low	Upflow/horizontal	1154	1120	1075	1027	972	838	692
NBC36B	9	Hi	Upflow/horizontal	1314	1258	1195	1142	1080	974	853
NBC36B	9	Low	Upflow/horizontal	1139	1105	1060	1012	957	823	677
NBC36B	14	Hi	Upflow/horizontal	1303	1248	1185	1129	1065	964	838
NBC36B	14	Low	Upflow/horizontal	1124	1090	1045	997	942	808	662
NBC36B	18	Hi	Upflow/horizontal	1293	1238	1170	1114	1052	952	823
NBC36B	18	Low	Upflow/horizontal	1109	1075	1030	982	927	799	647

INDOOR BLOWER COIL PERFORMANCE (DRY COIL @ 230 VOLTS 60 HZ (3)) (2)

TABLE 8

Model	KW	Speed	Position	IN H2O						
				.00	.10	.20	.30	.40	.50	.60
NBC36B	0	Hi	Counterflow	1305	1243	1173	1120	986	862	702
NBC36B	0	Low	Counterflow	1203	1135	1085	1004	897	764	649
NBC36B	5	Hi	Counterflow	1290	1228	1158	1105	971	847	687
NBC36B	5	Low	Counterflow	1188	1120	1070	989	882	749	634
NBC36B	9	Hi	Counterflow	1275	1219	1143	1090	956	832	672
NBC36B	9	Low	Counterflow	1173	1105	1055	974	867	734	619
NBC36B	14	Hi	Counterflow	1260	1198	1128	1075	941	817	657
NBC36B	14	Low	Counterflow	1158	1090	1040	959	852	719	604
NBC36B	18	Hi	Counterflow	1245	1183	1113	1060	926	802	642
NBC36B	18	Low	Counterflow	1143	1075	1025	944	837	704	589

(1) Values shown are standard for both bottom and side return air opening.

(2) Values shown are standard for bottom return air opening, side return air opening not available for counterflow.

(3) Reduce airflow values shown by 130 CFM for 208 volt operation.

NOTE: For 50 HZ applications, reduce CFM's by 17%.

I. APPLICATION AND LOCATION

GENERAL

Units are shipped completely assembled and internally wired, requiring only duct connections, thermostat wiring and external 208-240 volt AC power supply.

The NBC35B and NBC36B blower coil units, with various KW electric heat options are suitable for use with the following air conditioner and heat pump outdoor sections. It can be used both as an air conditioning system with electric heat and as a heat pump with electric heat. Refer to sections titled, "AIR CONDITIONING WITH ELECTRIC HEAT and HEAT PUMP WITH ELECTRIC HEAT" for complete information.

TABLE 9
APPROVED COMBINATIONS

Air Conditioning		Heat Pump	
<u>Outdoor Section</u>	<u>Indoor Section</u>	<u>Outdoor Section</u>	<u>Indoor Section</u>
NAC30QA	NBC35B & NBC36B	NHP30QA	NBC35B & NBC36B
NAC36QA	NBC35B & NBC36B	NHP36QA	NBC35B & NBC36B

UNPACKING

Upon receipt of equipment, carton should be checked for external signs of damage. If damage is found, request for inspection by carrier's agent should be made in writing immediately.

APPLICATION

Size of unit for a proposed installation should be based on heat loss calculation made according to methods of Air Conditioning Contractors of America. The air duct should be installed in accordance with the Standards of the National Fire Protection Association for the Installation of Air Conditioning and Ventilating Systems of Other Than Residence Type, NFPA No. 90A, and Residence Type Warm Air Heating and Air Conditioning System, NFPA No. 90B. Where local regulations are at a variance with instructions, installer should adhere to local codes.

DUCTWORK

Design the ductwork according to methods given by the Air Conditioning Contractors of America. When duct runs through unheated spaces, it should be insulated with a minimum of two inches of insulation. Use insulation with a vapor barrier on the outside of the insulation. Flexible joints should be used to connect the ductwork to the equipment in order to keep the noise transmission to a minimum.

LOCATION AND CLEARANCES

All access to the equipment is from one side, and at least 24 inches should be provided from this side for service access.

Unit casing is suitable for 0 inch clearance. The first four (4) feet of ductwork attached to the outlet (supply air) connections of the unit are to have a minimum of one inch clearance, with 0 inch clearance for any remaining ductwork.

FIGURE 2

A CFB35 combustible floor base is required for downflow installations to assure a 1" clearance from combustible materials to the outlet plenum (duct).

A 16-1/2 x 20-1/2 opening is required in the floor (mounting surface). See illustrations.

The CFB35 combustible floor base must be ordered separately. It is not included as part of the basic unit.

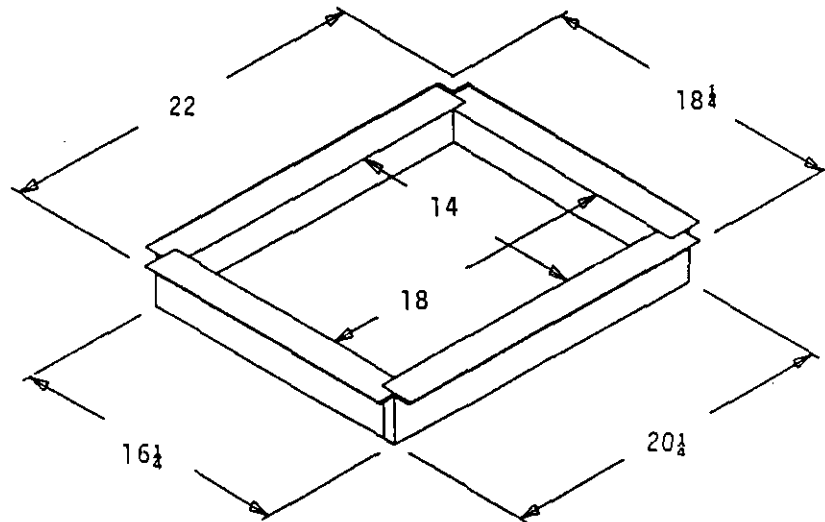

WARNING: Failure to provide the one inch clearance for the first four feet between the supply duct and a combustible surface can result in fire.

MOUNTING POSITIONS

The blower coil can be installed in three positions with respect to airflow direction: Upflow, horizontal and downflow (see Figure 1). The general intent of these mounting positions is shown on the cover page of this installation manual. Capacity and efficiency ratings are certified in the vertical installation position. Capacity may be reduced slightly for other installation positions.

The unit is shipped with the coil installed for upflow or horizontal position. It is secured in place by four screws, two on the top left support angles and two on the top right support angles. To convert to counterflow position, remove front access panel, remove the four screws securing coil pan assembly and remove coil.

Place cabinet in desired mounting position, and reinstall coil as shown on cover page. Make sure the coil is installed as shown with respect to blower.

IMPORTANT: The unit as received has coil installed for upflow/horizontal position only. It must be rotated 180 degrees for downflow positions. See note under "Condensate Drain."

EXPANSION DEVICE (NBC36B Only)

The flow control assembly has an orifice which provides the function of the expansion device as well as distributes the refrigerant equally to all evaporator circuits. It features a "take apart" brass body which houses the removable orifice which meters the proper amount of refrigerant flow and serves as the expansion device. This orifice can be removed and replaced.

There is an orifice shipped installed with the flow control in each coil. Refer to outdoor unit installation instructions to find if the orifice shipped installed is matched to the outdoor unit. Example: Outdoor unit NAC30QA with NA30AQ-A is a matched combination. For other combinations of indoor coil to outdoor unit application, the orifice in the flow control device MUST be changed to the size shown in the chart in the outdoor unit installation instructions. An additional proper sized orifice to be used with each outdoor unit is shipped packaged in the envelop with the installation instructions, with each outdoor unit. The installer should mark the size of the orifice installed on the rating plate of the indoor coil. The diameter of the orifice is stamped on the side of the orifice and on the plastic bag. Example: O63 indicates the orifice is .063" inside diameter.

CAUTION: Be sure there is no dirt introduced into the flow control--orifice assembly. Be sure and install the orifice with the bullet nose pointing in the proper direction as shown in Figure 3. Failure to do so will result in improper operation.

NOTE: If the orifice does not have to be changed, skip the instructions outlined further in Figure 3 and proceed to Figure 6 as applicable.

FIGURE 3
FLOW CONTROL ASSEMBLY
FIELD ORIFICE REPLACEMENT INSTRUCTIONS

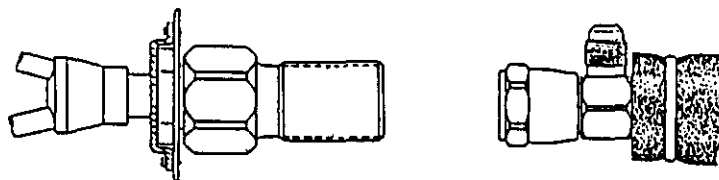

NOTE: DO NOT CONNECT LINE SETS! If orifice needs to be changed, change out orifice first.

STEP 1 Remove charge/pressure from indoor unit (if necessary--coupling style).

STEP 2 Disassemble Flow Control Assembly by turning body hex.

STEP 3 If existing orifice has not dropped out of the body when disassembled, remove by using a pin or paper clip. Discard this original orifice.

STEP 4 Insert properly sized orifice fully into the flow control body with rounded "bullet" nose towards the unit as shown. Insure the orifice stays inserted in body before connecting mating half. See chart in the outdoor unit installation instructions for proper size.

STEP 5 Thread assembly halves together by hand to insure proper mating of threads and tighten until bodies "bottom" or a definite resistance is felt.

STEP 6 Using a marker pen or ink pen, mark a line lengthwise from the union nut to the bulkhead. Then tighten an additional 1/6 turn (or 1 hex flat). The misalignment of the line will show the amount the assembly has been tightened. This final 1/6 turn is necessary to insure the formation of the leakproof joint.

STEP 7 Complete piping and installation of unit per installation instructions. See Figure 6 for detailed assembly instructions.

CAUTION WHEN USING 5780 SERIES COUPLINGS

If coupling is every disconnected, the Flow Control Assembly connection may also be loosened. If this should occur, care must be taken to avoid loss of the orifice. If loosened, repeat Step 5 above to insure the reformation of leakproof joint.

FIGURE 4
FLOW CONTROL FIELD ASSEMBLY PROCEDURES
PRECHARGE COUPLING LINE SET

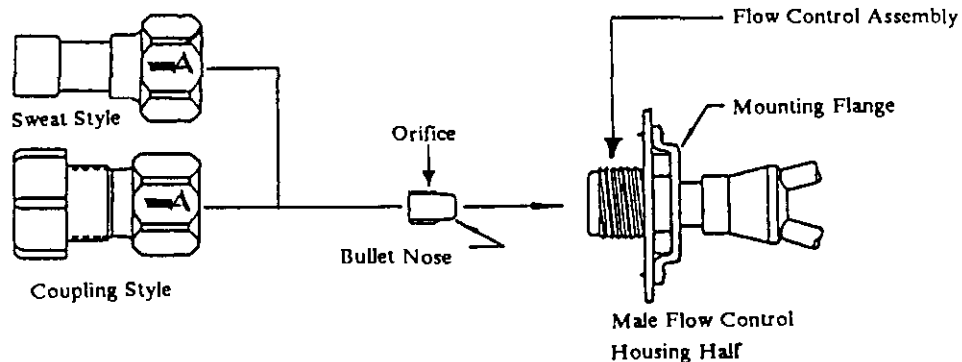

STEP 8 Route the suction and liquid line between the indoor and outdoor unit. **CAUTION:** Do NOT connect the tubing to the outdoor unit yet.

STEP 9 Remove protector caps and plugs.

STEP 10 If necessary, carefully wipe coupling seats and threaded surfaces with a clean cloth to prevent the inclusion of dirt or any foreign material in the system.

STEP 11 LUBRICATE male half diaphragm and synthetic rubber seal with refrigerant oil. Thread coupling halves together by hand to insure proper mating of threads. Use proper size wrenches (on line set coupling body hex and on union nut) and tighten until coupling bodies "bottom" or a definite resistance is felt.

STEP 12 Using a marker or ink pen, mark a line lengthwise from the coupling union nut to the bulkhead. Then tighten an additional 1/4 turn; the misalignment of the line will show the amount the coupling has been tightened. This final 1/4 turn is necessary to insure the formation of leakproof joint. If a torque wrench is used, torque values recommends 10 to 12 foot pounds.

STEP 13 Evacuate the lines and indoor unit before connecting to the outdoor unit. Refer to the installation instructions packed with the outdoor unit for details on setting the proper refrigerant charge. **NOTE:** The lines and indoor coil do not have to be evacuated if they were not opened to the atmosphere to change the orifice.

CONDENSATE DRAIN

Determine where the drain line will run. This drain line contains cold water and must be insulated to avoid drops of water from dropping on ceiling, etc. A trap must be installed in the primary drain line below the bottom of the drain pan.

For horizontal installations with auxiliary drain pan, a separate drain line should be run from the auxiliary drain pan and terminated where the homeowner can see it. Be certain to show the homeowner the location of the drain line and to explain its purpose. In the event of overflow of primary drain, water will collect in auxiliary pan and run out through the auxiliary drain line.

It is not recommended that any condensate drain lines be connected to sewer main. Drain lines must be installed in accordance with local codes.

When installed horizontal in an attic installation, a platform should be made for the unit to sit on. This platform can be made from 3/4 inch plywood or boards. An auxiliary drain pan should always be used when equipment is installed over a finished living area, to provide protection from water damage in case of plugging of the primary drain line from the unit condensate collection pan.

Secure 4 pieces of cork or live rubber, 4" x 4", of sufficient thickness to allow primary drain to clear edge of auxiliary drain pan, under each corner of the unit.

NOTE: There are two 3/8" copper tubes brazed through the coil drain pan approximately 2 inches from the 3/4 inch main drain pipe coupling. These are overflow drains to control the point at which water would exit the drain pan in the event the primary drain becomes plugged. When ever the coil assembly is removed and reinstalled, make sure the 3/8" drain overflow tubes extend slightly beyond the coil door when in place.

II. WIRING

THERMOSTAT LOW-VOLTAGE WIRING

A 24V terminal block is mounted on the inside of the unit. There is also a 24V terminal block located in the outdoor section of remote heat pumps and two tagged 24V wires in the outdoor section of remote air conditioners. Wire sizing is determined from the table below for 24V control circuit wiring.

<u>Transformer VA</u>	<u>FLA @ 240V</u>	<u>Maximum Distance in Feet (1)</u>
55	2.3	20 gauge - 45 18 gauge - 60 16 gauge - 100 14 gauge - 160 12 gauge - 250

(1) For split systems, this is the maximum distance between the indoor section and outdoor section, and between the indoor section and thermostat each could be up to 90 feet for 18 gauge and 65 feet for 20 gauge on 40VA transformer.

Specific control circuit wiring diagrams for the various applications are referenced in the sections titled "AIR CONDITIONING WITH ELECTRIC HEAT and HEAT PUMP WITH ELECTRIC HEAT." These diagrams detail the recommended controls and wiring to allow the best possible operation of the different types of systems with respect to energy conservation while still maintaining close comfort levels for the occupant.

UNIT OPERATION

The controls in the NBC35B and NBC36B provide for manual/auto fan control in addition to the staging of the installed electric heat. Staging is accomplished in basic 9KW increments, that is, each two (2) heating elements are controlled by one heat relay.

TABLE 11
HEATER ELEMENT STAGING

Heater KW	Stages
5, 9	1
14, 18	2

Heater stage designations are as follows on the 24V terminal strip:

W2	1st stage
W3	2nd stage
DB	3rd stage

AIR CONDITIONING WITH ELECTRIC HEAT

Typical situations would be to utilize a 1-stage cool, 1-stage heat wall thermostat for 5 and 9KW applications, and a 1-stage cool/2-stage heat thermostat for 14 and 18KW applications. Listed below are the appropriate control circuit connection diagrams based upon KW rating and also the number of field installed outdoor thermostats required for each application.

TABLE 12

KW Rating	Connection Diagram	Quantity Outdoor Thermostats
0	4091-300	0
5, 9	4091-301	0
14, 18	4091-303	0

HEAT PUMP WITH ELECTRIC HEAT

The system and its safety controls are designed in such a manner that the heat pump and up to 18KW of the resistance strip heaters can operate at the same time, being brought on in stages.

Listed below are the appropriate control circuit connection diagrams based on KW rating, and also the number of field installed outdoor thermostats recommended for each application.

TABLE 13

KW Rating	Connection Diagram	Quantity Outdoor Thermostats
0	4091-400	0
5, 9	4091-401	1
14, 18	4091-403	1

In geographical areas where compressor cut-off would not be required because winter temperatures below 10 degrees F are never experienced, disregard the compressor cut-off wiring shown on the control circuit diagram.

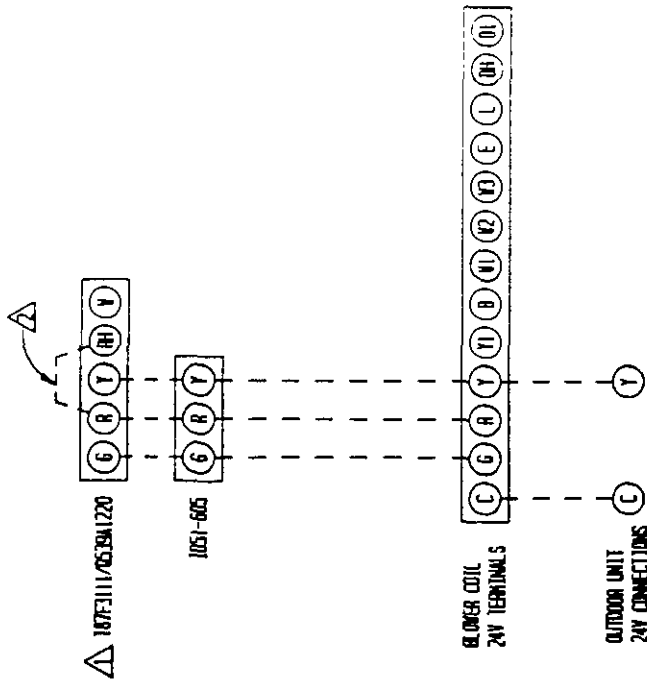

△ SET ADJUST HEAT ANTICIPATOR (SEE BLOWER COIL INSTRUCTIONS).

△ INSTALL JUMPER R-RH

AIR CONDITIONER V/OVKY BLOWER COIL

LOW VOLTAGE	FACTORY WIRING	FIELD WIRING
HIGH VOLTAGE	—————	-----

4091-300

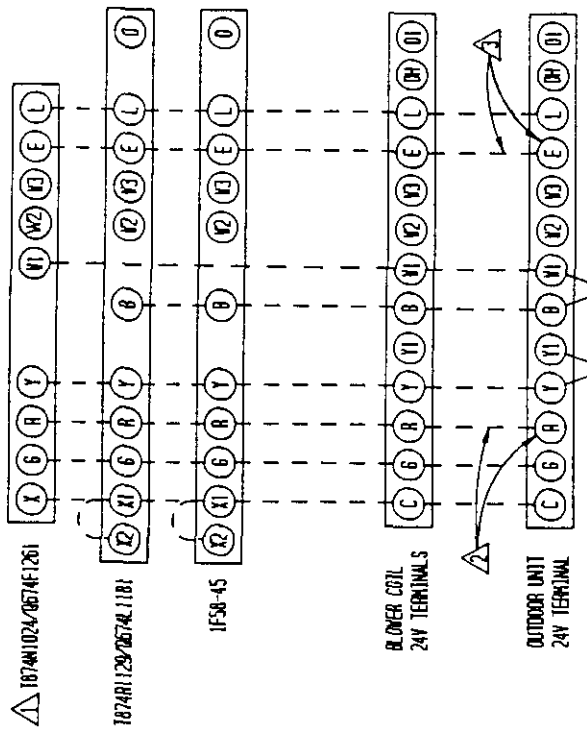

HEATPUMP V/OVKY BLOWER COIL

△ SET ADJUST HEAT ANTICIPATOR (SEE BLOWER COIL INSTRUCTIONS).

△ 18-36RPO UNITS DO NOT HAVE (E) TERMINAL AND IT IS NOT REQUIRED TO RUN AN (E) WIRE TO THESE MODELS.

△ 42-60RPO UNITS DO NOT HAVE (E) TERMINAL AND IT IS NOT REQUIRED TO RUN AN (E) WIRE TO THESE MODELS.

LOW VOLTAGE	FACTORY WIRING	FIELD WIRING
HIGH VOLTAGE	—————	-----

4091-100A

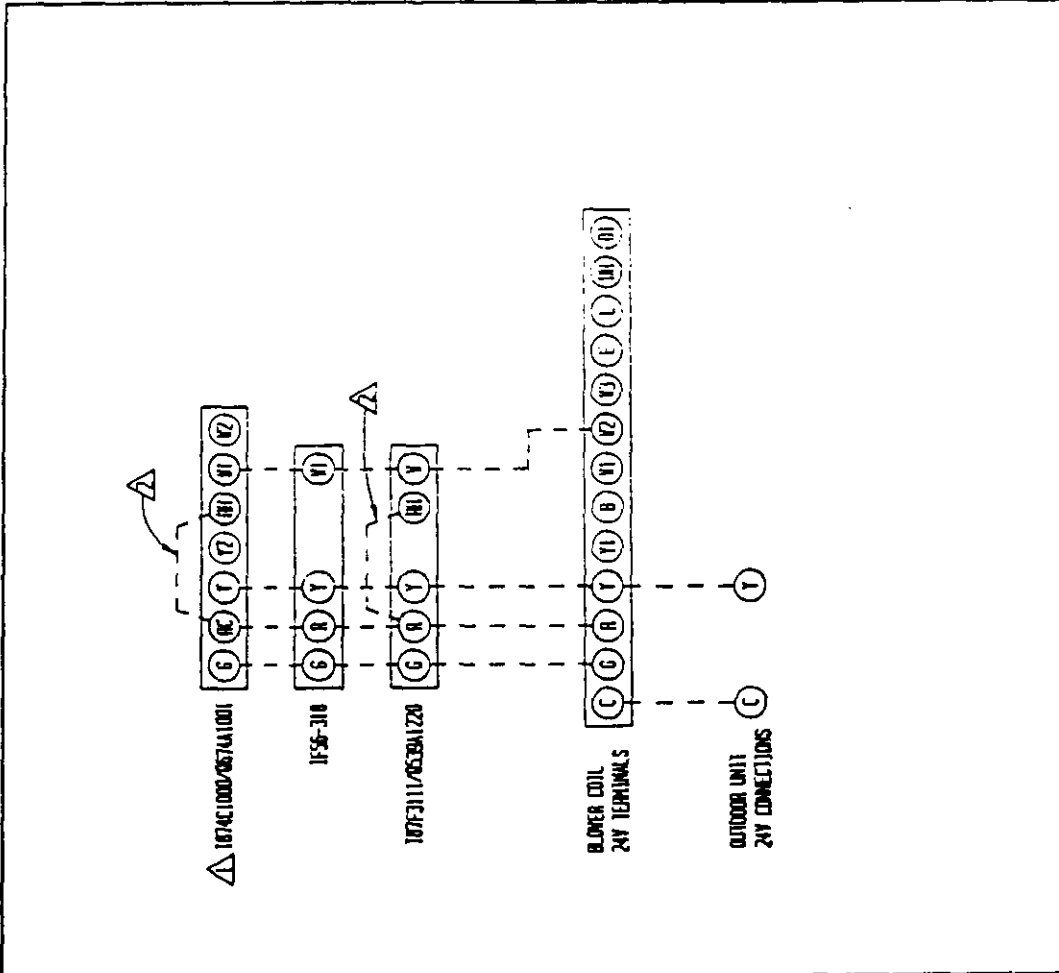

4031-301

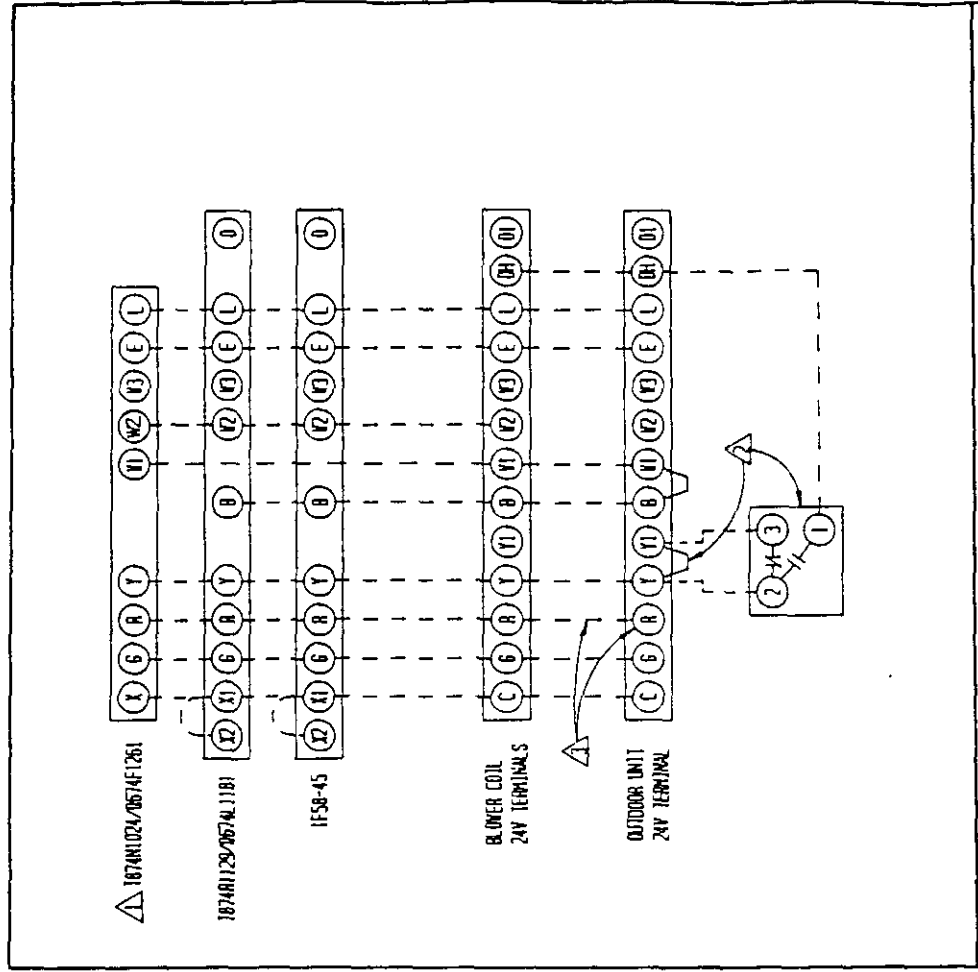

HEATPUMP V/S TO 10RY BLOWER COIL

4091-401B

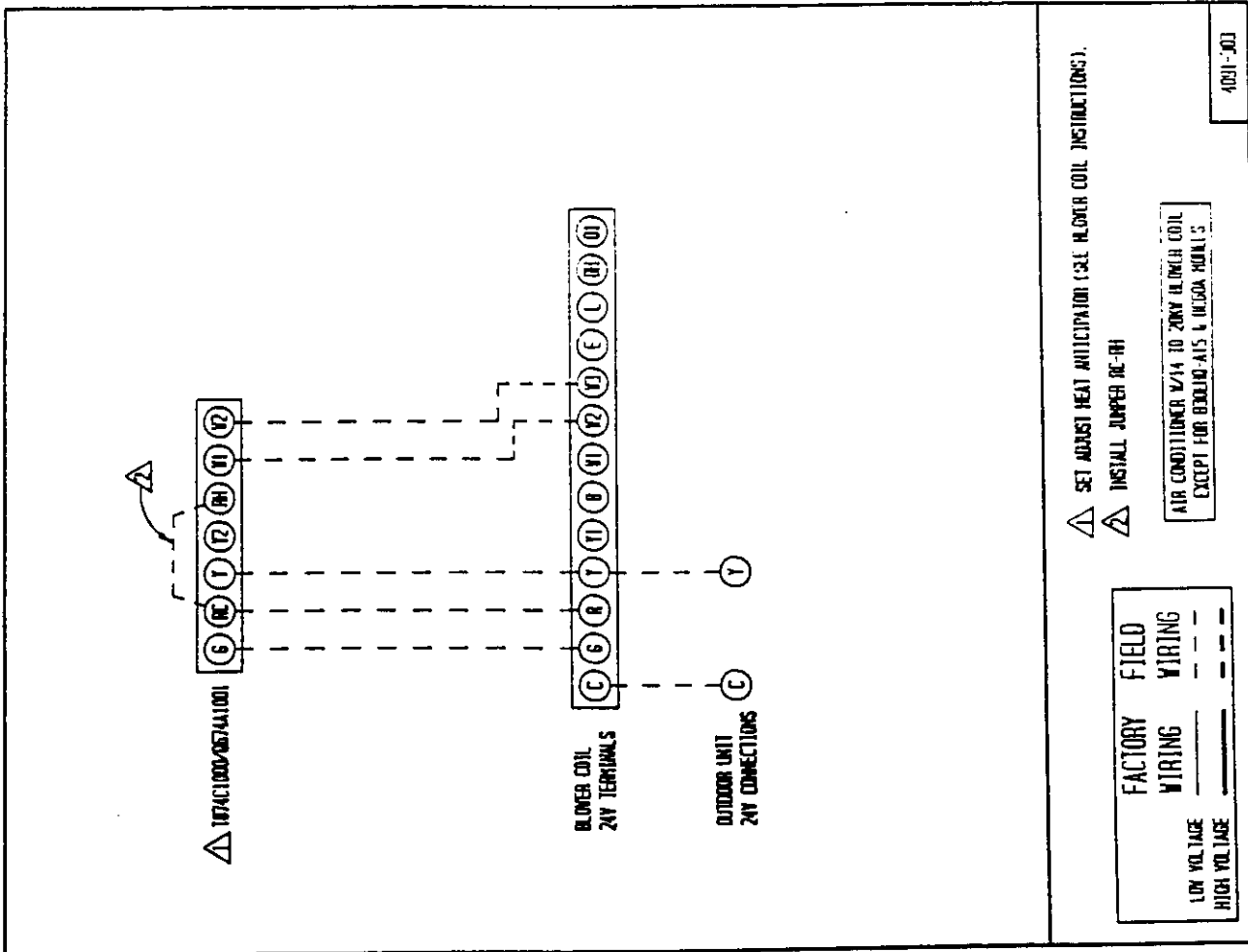

△ SET ADJUST HEAT ANTICIPATOR (SEE BLOWER COIL INSTRUCTIONS).

△ INSTALL JUMPER RE-RH

AIR CONDITIONER W/14 TO 20KV BLOWER COIL EXCEPT FOR B3000-A15 & B3000-A15'S

4091-300

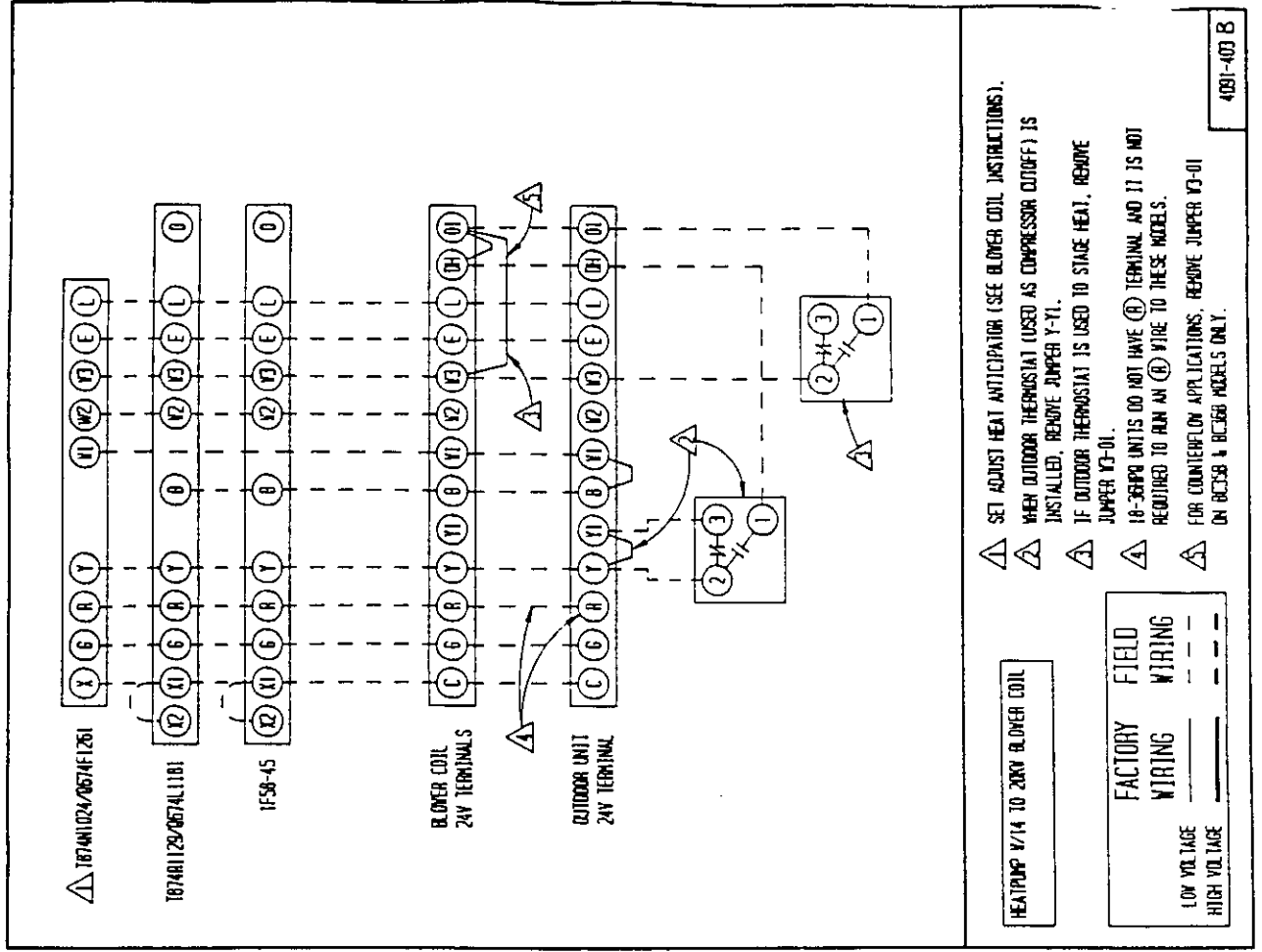

△ SET ADJUST HEAT ANTICIPATOR (SEE BLOWER COIL INSTRUCTIONS).

△ WHEN OUTDOOR THERMOSTAT (USED AS COMPRESSOR CUTOFF) IS INSTALLED, REMOVE JUMPER Y-Y1.

△ IF OUTDOOR THERMOSTAT IS USED TO STAGE HEAT, REMOVE JUMPER Y3-01.

△ 10-36000 UNITS DO NOT HAVE (A) TERMINAL AND IT IS NOT REQUIRED TO RUN AN (B) WIRE TO THESE MODELS.

△ FOR CONDENSER APPLICATIONS, REMOVE JUMPER Y3-01 ON B358 & B358 MODELS ONLY.

4091-400 B

WALL THERMOSTATS

The following wall thermostats and subbases should be used as indicated, depending on the application.

TABLE 14

AIR CONDITIONING THERMOSTATS	
Model No.	Description
T87F3111 Q539A1220	THERMOSTAT--1 stg. heat, adj. heater, Mercury SUBBASE --System Heat-Off-Cool Fan: On-Auto
ID51-605	THERMOSTAT--1 stg. cool, System w/Off Sw. Snap Action Fan: Auto-On
IF56-318	THERMOSTAT--1 st. cool, 1 stg. heat, Adj. heater Mercury System: Heat-Off-Cool Fan: Auto-On
T874C1000 Q674A1001	THERMOSTAT--1 stg. cool, 2 stg. heat, Adj. heater, Mercury SUBBASE --System: Heat-Auto-Cool Fan: Auto-On
HEAT PUMP THERMOSTATS	
Model No.	Description
T874R1129 Q674L1181	THERMOSTAT--1 stg. cool, 2 stg. heat, 1st stage fixed, 2nd stg. adj. heat anticipators SUBBASE --System switch: Em. Heat-Heat-Off-Cool Fan switch: On-Auto SPECIAL FEATURE: Manual Changeover (Non-Cycling Rev. Valve) Em. heat light and System check light
T874N1024 Q674P1261	THERMOSTAT--1 stg. cool, 2 stg. heat, 1st stage fixed, 2nd stg. adj., heat anticipators SUBBASE --System switch: Off-Cool-Auto-Heat-Em.Ht. Fan switch: On-Auto SPECIAL FEATURE: Auto system changeover, Em. heat light and System check light
IF58-45	THERMOSTAT--1 stg. cool, 2 stg. heat, 1st stage fixed, 2nd stg. adj. heater System switch: Em. Heat-Heat-Off-Cool Fan Switch: On-Auto

HOW TO SET AN ADJUSTABLE ANTICIPATOR

The primary purpose of the adjustable anticipator thermostat is to provide a single thermostat to match almost any type of primary control in the field today.

Figure 5

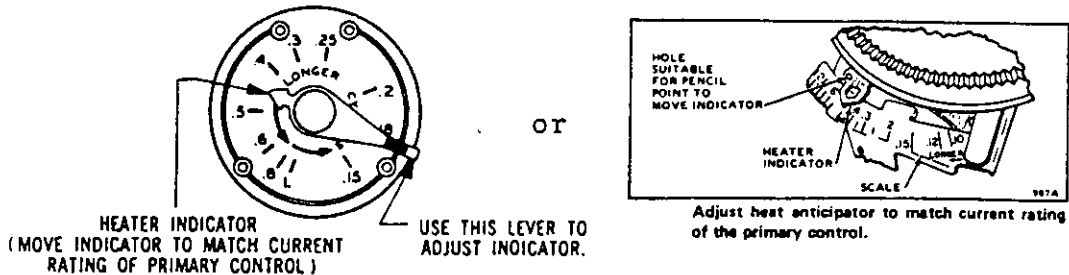

The adjustable heat anticipator has a slide wire adjustment with the pointer scale marked in tenths of an ampere. This is used to set the anticipator to agree with the control amp draw of the control system in use.

If the primary control nameplate has no rating or if further adjustment is necessary, use the following procedure to determine the current draw of each stage.

The current draw of each heating stage must be measured with the thermostat removed and the power on.

1. Connect an AC ammeter of appropriate range between the heating terminals of the subbase.

Stage 1 -- between W1 and RH or R

Stage 2 -- between W2 and RH or R

2. Move the system switch to HEAT or AUTO.
3. After one minute, read the ammeter and record the reading.
4. After mounting the thermostat, set the adjustable heat anticipator(s) to match the respective reading(s) measured in Step 3.

If you want to change the cycle of the heating system, you can make a simple adjustment on the anticipator to do this.

Additional adjustment, if necessary, may be made as follows:

Heater cycles too short--set adjustable heater to a slightly higher dial setting (1/2 division).

Heater cycles too long--set adjustable heater to a slightly lower dial setting (1/2 division).

Occasionally you may find a system where longer or shorter cycles of the primary control are desirable. If the primary control draws .45 amps and you want a longer cycle, set the anticipator to .5 or .6 amps. This puts less resistance in the circuit. With less resistance, but the same current (from the primary control), you will generate less "false" heat and get a longer cycle of the primary control.

If a setting of .45 amps on the adjustable anticipator gives a cycle that is longer than desired, reset the indicator to .3 or .25 amps. This will put more resistance in the circuit and thus generate more "false" heat for shorter cycles.

ADDITIONAL INFORMATION FOR ELECTRIC HEAT OR HEAT PUMP APPLICATIONS

Adjust heat anticipator to match current rating of heating relay for W1 (and W2 if 2 stage). Move indicator on the scale to correspond with this current rating.

If the current rating is not given, proceed as follows:

1. Wrap exactly 10 loops of thermostat wire (W1) around the prongs of an Amprobe.
2. Let the heating system operate for one minute before reading the W1 or W2 current draw.
3. Divide the reading obtained in Step 2 by 10.
4. Use the value calculated in Step 3 to set the heat.
5. Repeat the procedure for (W2) if 2 stage heat anticipator.

NOTE: Cooling anticipators on all thermostats are fixed and do not require setting.

FIGURE 6

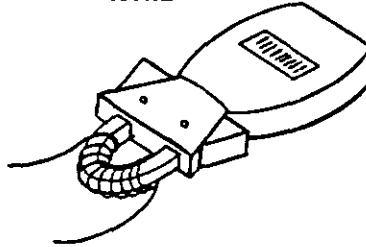

Example: $\frac{6.0 \text{ Amp}}{10 \text{ loops}} = .6A$

III. SERVICE

TWO SPEED BLOWER MOTOR

The BC35B and BC36B both have a two speed, 1/3 hp blower motor.

Motor lead wire identification is as follows:

Common	Yellow
High	Black
Low	Red
Capacitor	Brown

Both models are shipped wired on high speed. The unused red (low speed) lead wire is taped off. If low speed operation is desired, remove and tape black wire from terminal com. on blower relay and connect red wire to terminal com. Refer to wiring diagrams for electrical circuitry and to airflow charts for capabilities and limitations on blower speeds, static pressures and air delivery versus installed KW heaters.

BLOWER MOTOR OILERS

The blower motors should be oiled twice a year with approximately 8 - 10 drops of 20 weight motor oil. DO NOT over oil and DO NOT use 3-in-1 oil or any other light oil.

IMPORTANT NOTE FOR DOWNFLOW INSTALLATION: Loosen belly-band bolt securing motor enough to rotate motor so oilers are above either 3 or 9 o'clock position so oilers do not drain and to permit reoiling.

FILTER

These units come equipped with a 16" x 20" x 1" thick disposable fiberglass filter and must not be operated without a filter in place. Filter access is gained by removing an angle piece located at the bottom of the main unit cabinet (as viewed in upflow position).

The filter should be replaced periodically throughout the year, as these are year-round heat-cool systems. Special attention should be given to filter cleanliness on any new installation, as airborne dust and debris from recent construction can easily plug a filter in a matter of days.

Dirty filters are the most prevalent and most easily corrected problem to be encountered in any forced air heating and/or cooling system.

LADDER DIAGRAM

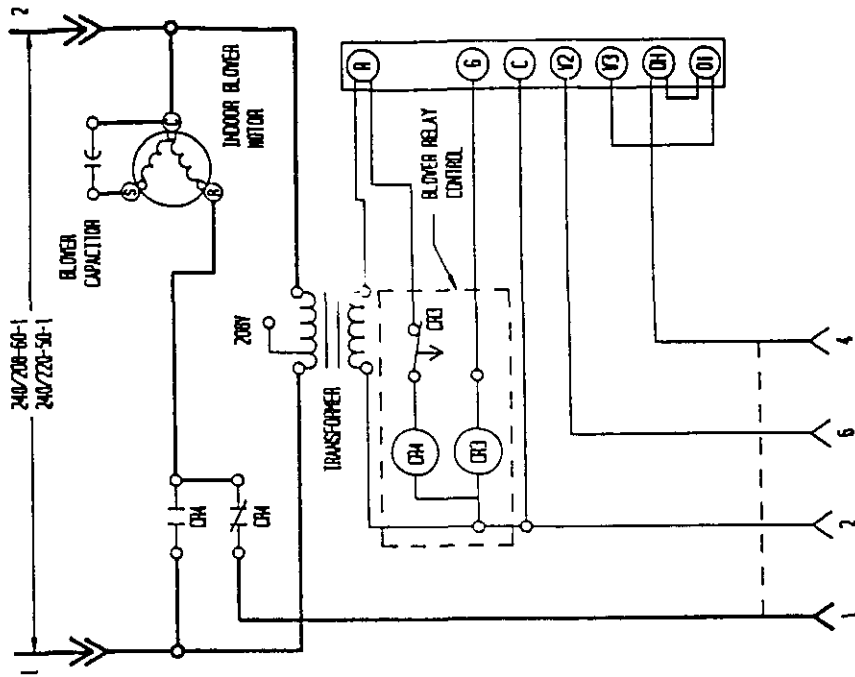

WIRE COLOR	MOTOR SPEED
YELLOW	COMMON
BLACK	HIGH
BLUE	MEDIUM
RED	LOW

MODEL	CAPACITOR
BC248	5/370
BC35B	7.5/440
BC36B	
BC48B	
BC60B	

4085-111

DANGER: ELECTRICAL SHOCK HAZARD.
DISCONNECT POWER BEFORE SERVICING.

CONNECTION DIAGRAM

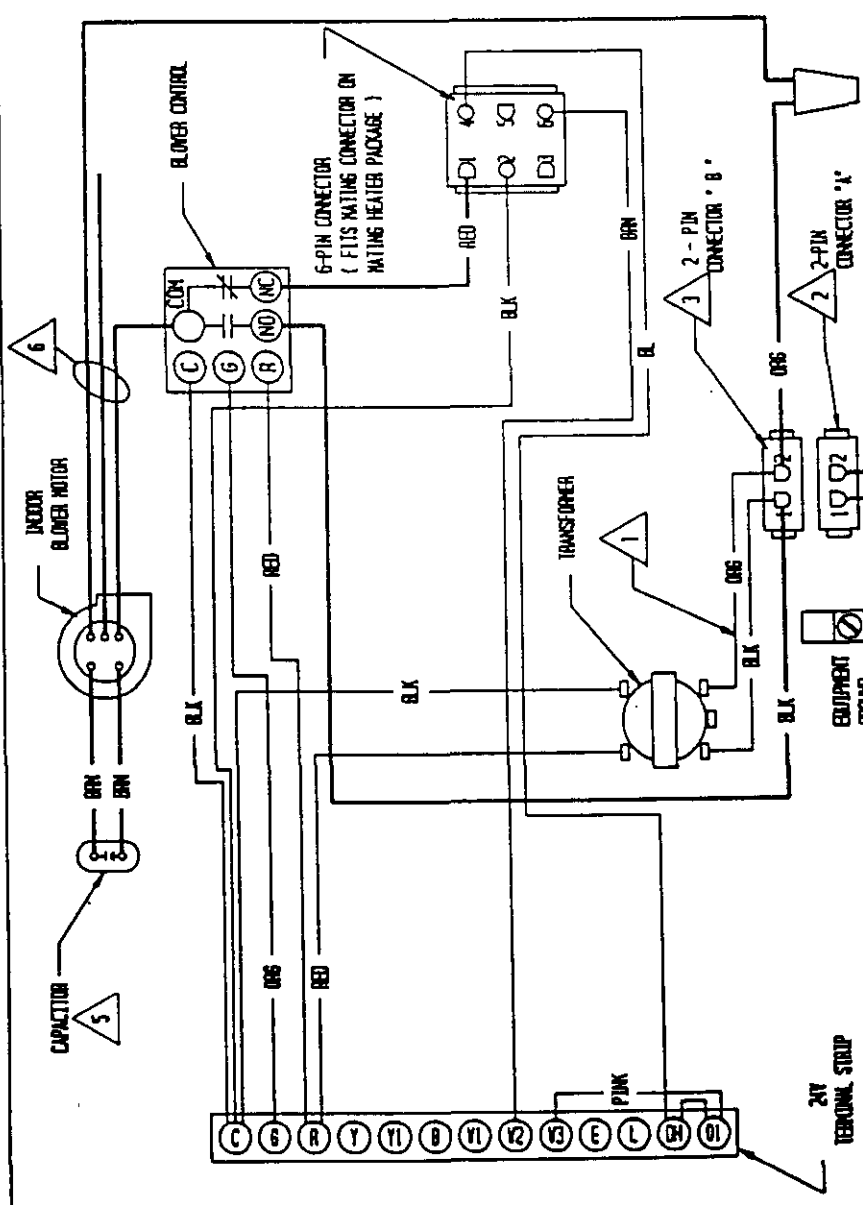

WIRING TYPE	FIELD WIRING
Low Voltage	FACTORY WIRING
High Voltage	FIELD WIRING

240/200-60-1
240/220-50-1

REFER TO INSTALLATION INSTRUCTIONS FOR CONTROL CIRCUIT WIRING

- FOR 200V OPERATION WIRE THIS WIRE TO THE 200V TRANSFORMER TAP
- 2-PIN CONNECTOR 'A' USED FOR FIELD CONNECTION WHEN NO HEATER PACKAGE IS INSTALLED.
- WHEN HEATER PACKAGE IS INSTALLED, CONNECTOR 'B' CONNECTS TO MATING CONNECTOR ON HEATER PACKAGE.

