INSTALLATION INSTRUCTIONS

WALL MOUNTED PACKAGE AIR CONDITIONERS

MODELS

WA381

WA421

WA482

WA491

WA602



CLIMATE CONTROL SOLUTIONS

Bard Manufacturing Company
Bryan, Ohio 43506

Since 1914...Moving ahead just as planned.

Manual : 2100-218J
Supersedes: 2100-218I
File: Volume III Tab 16
Date: 05-09-01

Contents

Getting Other Information and Publications 1

Wall Mount General Information

Heat Pump Wall Mount Model Nomenclature	2
Shipping Damage	5
General	5
Duct Work	6
Filters	6
Fresh Air Intake	6
Condensate Drain	6

Installation Instructions

Wall Mounting Information	7
Mounting the Unit	7
Wiring – Main Power	12
Wiring – Low Voltage Wiring	12

Figures

Figure 1 Unit Dimensions	3
Figure 2 Fresh Air Damper Assembly	6
Figure 3 Mounting Instructions	8
Figure 4 Electric Heat Clearance	9
Figure 5 Wall Mounting Instructions	10
Figure 6 Wall Mounting Instructions	10
Figure 7 Common Wall Mounting Installations	11
Figure 8 Unit 24V Terminal Board	13
Figure 9 Starting Procedure	14
Figure 10 Fan Blade Setting	17

Start Up

Important Installer Note	14
Crankcase Heaters	14
High Pressure Switch	14
Three Phase Scroll Compressor Start Up	14
Condenser Fan Operation	14
Service Hints	15
Sequence of Operation	15
Compressor Control Module	15
Adjustments	15
Phase Monitor	16
Pressure Service Ports	16

Troubleshooting

Fan Blade Setting Dimensions	17
Removal of Fan Shroud	17
Refrigerant Charge	17
Pressure Table	19
Optional Accessories	20

Tables

Table 1 Electric Heat Table	2
Table 2 Electrical Specifications	4 and 5
Table 3 Thermostat Wire Size	12
Table 4 Wall thermostat and Subbase Combinations	12
Table 5 Fan Blade Dimensions	17
Table 6 Refrigerant Charge	17
Table 7 Indoor Blower Performance	17
Table 7A Indoor Blower Performance	18
Table 8 Recommended Air Flow	18
Table 9 Maximum EXP Electric Heat Only	18
Table 9A Maximum EXP Electric Heat Only	18
Table 10 Pressure Table	19
Table 11 Optional Accessories	20

Getting Other Information and Publications

These publications can help you install the air conditioner or heat pump. You can usually find these at your local library or purchase them directly from the publisher. Be sure to consult current edition of each standard.

National Electrical Code ANSI/NFPA 70

Standard for the Installation ANSI/NFPA 90A
of Air Conditioning and
Ventilating Systems

Standard for Warm Air ANSI/NFPA 90B
Heating and Air
Conditioning Systems

Load Calculation for ACCA Manual J
Residential Winter and
Summer Air Conditioning

Duct Design for Residential ACCA Manual D
Winter and Summer Air Conditioning
and Equipment Selection

FOR MORE INFORMATION, CONTACT THESE PUBLISHERS:

ACCA **Air Conditioning Contractors of America**
1712 New Hampshire Ave. N.W.
Washington, DC 20009
Telephone: (202) 483-9370
Fax: (202) 234-4721

ANSI **American National Standards Institute**
11 West Street, 13th Floor
New York, NY 10036
Telephone: (212) 642-4900
Fax: (212) 302-1286

ASHRAE **American Society of Heating, Refrigeration
and Air Conditioning Engineers, Inc.**
1791 Tullie Circle, N.E.
Atlanta, GA 30329-2305
Telephone: (404) 636-8400
Fax: (404) 321-5478

NFPA **National Fire Protection Association**
Batterymarch Park
P.O. Box 9101
Quincy, MA 02269-9901
Telephone: (800) 344-3555
Fax: (617) 984-7057

MANUFACTURED UNDER THE FOLLOWING
U.S. PATENT NUMBERS:
5,485,878; 5,301,777; 5,002,116; 4,924,934;
4,875,520; 4,825,936; 4,432,409

WALL MOUNT GENERAL INFORMATION

HEAT PUMP WALL MOUNT MODEL NOMENCLATURE

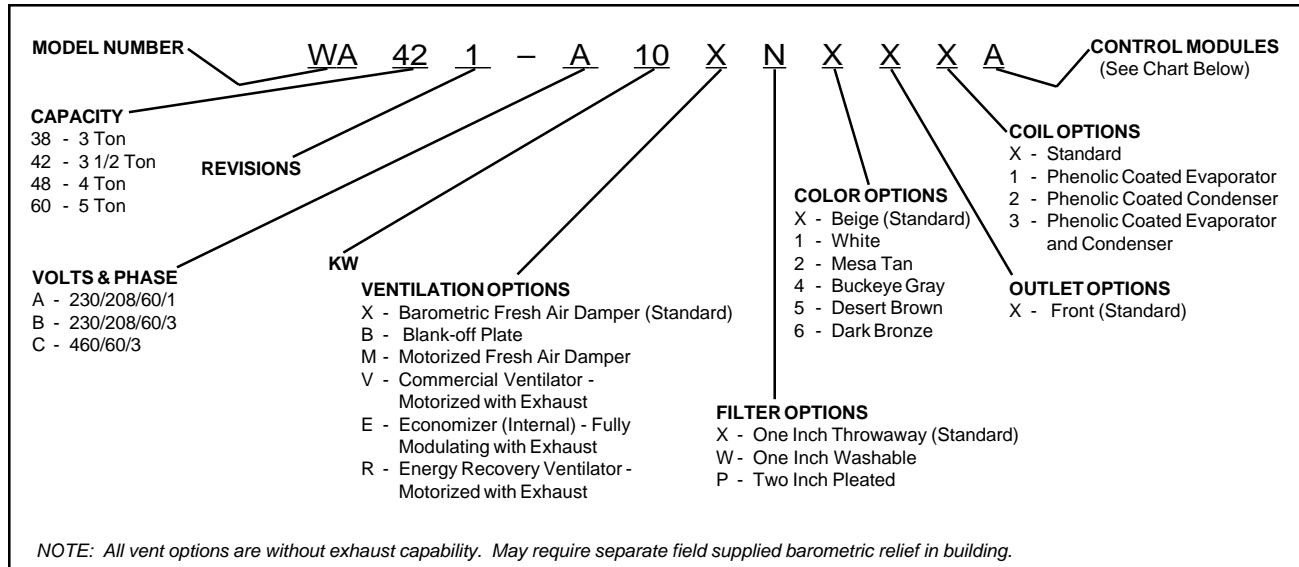
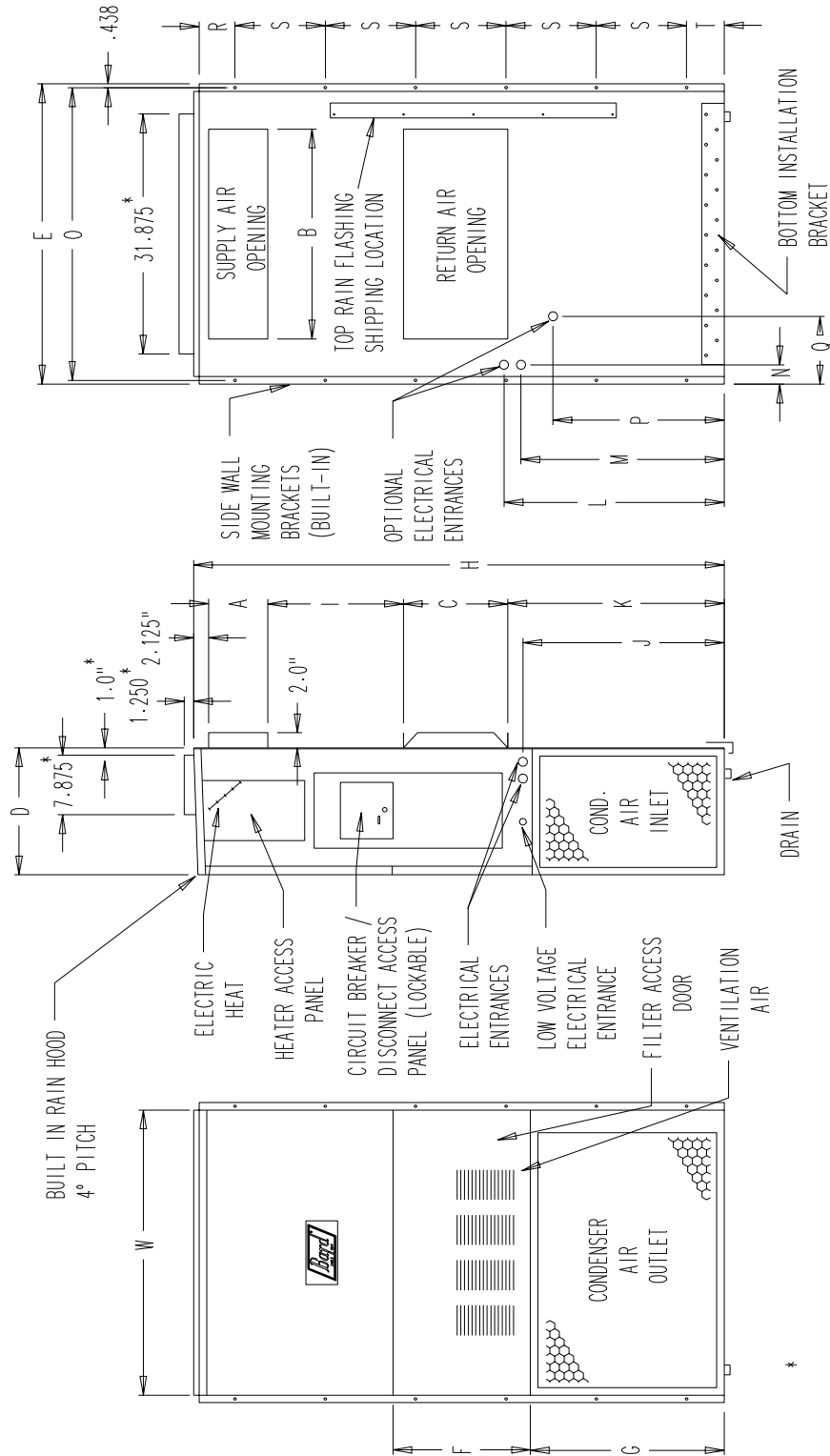

**TABLE 1
ELECTRIC HEAT TABLE**

Models	WA381-A WA421-A WA482-A WA491-A WA602-A				WA381-B WA421-B WA482-B WA491-B WA602-B				WA381-C WA421-C WA482-C WA491-C WA602-C		
	230-1		208-1		230-3		208-3		460-3		
	KW	A	BTU	A	BTU	A	BTU	A	BTU	A	BTU
5	20.8	17050	18.1	12800							
6					14.4	20500	12.5	15360	7.2	20480	
8	33.3	27280	28.8	20450							
9					21.7	30600	18.7	23030	10.8	30700	
10	41.6	34130	36.2	25600							
15	62.5	51200	54.0	38400	36.2	51200	31.2	38400	17.3	47000	
18					43.3	61430	37.5	46100			
20	83.2	68260	72.1	51200							

**FIGURE 1
UNIT DIMENSIONS**

Model	Width (W)	Depth (D)	Height (H)	Supply		Return		E	F	G	I	J	K	L	M	N	O	P	Q	R	S	T		
				A	B	C	B																	
WA38																								
WA42																								
WA48	42.075	22.432	84.875	9.88	29.88	15.88	29.88	43.88	19.10	31.66	30.00	32.68	26.94	34.69	32.43	3.37	42.88	23.88	10.00	1.44	16.00	1.88		
WA49																								
WA60																								



FRONT VIEW

SIDE VIEW

BACK VIEW

MIS-1262

**TABLE 2
ELECTRICAL SPECIFICATIONS**

Model	SINGLE CIRCUIT						DUAL CIRCUIT							
	Rated Volts & Phase	No. Field Power Circuits	③	①	②	②	③		①		②		②	
			Minimum Circuit Ampacity	Maximum External Fuse or Circuit Breaker	Field Power Wire Size	Ground Wire Size	Minimum Circuit Ampacity	Maximum External Fuse or Circuit Breaker	Field Power Wire Size	Ground Wire Size	CKT A	CKT B	CKT A	CKT B
WA381-A00, A0Z A05 A08 A10	230/208-1	1 1 1 1	25 32 47 58	35 35 50 60	8 8 8 6	10 10 10 10	N/A N/A N/A N/A	N/A N/A N/A N/A	N/A N/A N/A N/A	N/A N/A N/A N/A	N/A N/A N/A N/A	N/A N/A N/A N/A	N/A N/A N/A N/A	N/A N/A N/A N/A
WA381-B00, B0Z B06 B09	230/208-3	1 1 1	20 24 33	30 30 35	10 10 8	10 10 10	N/A N/A N/A	N/A N/A N/A	N/A N/A N/A	N/A N/A N/A	N/A N/A N/A	N/A N/A N/A	N/A N/A N/A	N/A N/A N/A
WA381-C00, C0Z C06 C09	460-3	1 1 1	11 13 17	15 15 20	14 14 12	14 14 12	N/A N/A N/A	N/A N/A N/A	N/A N/A N/A	N/A N/A N/A	N/A N/A N/A	N/A N/A N/A	N/A N/A N/A	N/A N/A N/A
WA421-A00, A0Z A05 A10 A15 A20	230/208-1	1 1 1 1 or 2 1 or 2	33 33 59 85 110	50 50 60 90 110	8 8 6 4 2	10 10 10 8 6	N/A N/A N/A 56 56	N/A N/A N/A 26 52	N/A N/A N/A 60 60	N/A N/A N/A 30 60	N/A N/A N/A 6 6	N/A N/A N/A 10 10	N/A N/A N/A 10 10	N/A N/A N/A 10 10
WA421-B00, B0Z B09 B15 B18	230/208-3	1 1 1 1	24 34 52 60	35 35 50 60	8 8 6 6	10 10 10 10	N/A N/A N/A N/A	N/A N/A N/A N/A	N/A N/A N/A N/A	N/A N/A N/A N/A	N/A N/A N/A N/A	N/A N/A N/A N/A	N/A N/A N/A N/A	N/A N/A N/A N/A
WA421-C00, C0Z C09 C15	460-3	1 1 1	12 17 26	15 20 30	14 12 10	14 12 10	N/A N/A N/A	N/A N/A N/A	N/A N/A N/A	N/A N/A N/A	N/A N/A N/A	N/A N/A N/A	N/A N/A N/A	N/A N/A N/A
WA482-A00, A0Z A05 A10 A15 A20	230/208-1	1 1 1 1 or 2 1 or 2	38 38 59 85 110	50 50 60 90 110	8 8 6 4 2	10 10 10 8 6	N/A N/A N/A 59 59	N/A N/A N/A 26 52	N/A N/A N/A 60 60	N/A N/A N/A 30 60	N/A N/A N/A 6 6	N/A N/A N/A 10 10	N/A N/A N/A 10 10	N/A N/A N/A 10 10
WA482-B00, B0Z B09 B15 B18	230/208-3	1 1 1 1	26 34 52 60	35 35 60 60	8 8 6 6	10 10 10 10	N/A N/A N/A N/A	N/A N/A N/A N/A	N/A N/A N/A N/A	N/A N/A N/A N/A	N/A N/A N/A N/A	N/A N/A N/A N/A	N/A N/A N/A N/A	N/A N/A N/A N/A
WA482-C00, C0Z C09 C15	460-3	1 1 1	13 17 26	15 20 30	14 12 10	14 12 10	N/A N/A N/A	N/A N/A N/A	N/A N/A N/A	N/A N/A N/A	N/A N/A N/A	N/A N/A N/A	N/A N/A N/A	N/A N/A N/A
WA491-A00, A0Z A05 A08 A10	230/208-1	1 1 1 1	33 33 47 58	50 50 50 60	8 8 8 6	10 10 10 10	N/A N/A N/A N/A	N/A N/A N/A N/A	N/A N/A N/A N/A	N/A N/A N/A N/A	N/A N/A N/A N/A	N/A N/A N/A N/A	N/A N/A N/A N/A	N/A N/A N/A N/A
WA491-B00, B0Z B06 B09	230/208-3	1 1 1	27 27 33	40 40 40	8 8 8	10 10 10	N/A N/A N/A	N/A N/A N/A	N/A N/A N/A	N/A N/A N/A	N/A N/A N/A	N/A N/A N/A	N/A N/A N/A	N/A N/A N/A
WA491-C00, C0Z C06 C10	460-3	1 1 1	13 13 17	15 15 20	14 14 12	14 14 12	N/A N/A N/A	N/A N/A N/A	N/A N/A N/A	N/A N/A N/A	N/A N/A N/A	N/A N/A N/A	N/A N/A N/A	N/A N/A N/A

TABLE CONTINUED ON PAGE 5

- ① Maximum size of the time delay fuse or HACR type circuit breaker for protection of field wiring conductors.
- ② Based on 75° C copper wire. All wiring must conform to NEC and all local codes.
- ③ These "Minimum Circuit Ampacity" values are to be used for sizing the field power conductors. Refer to the National Electric Code (latest revision), article 310 for power conductor sizing. *CAUTION: When more than one field power conductor circuit is run through one conduit, the conductors must be derated. Pay special attention to note 8 of table 310 regarding Ampacity Adjustment Factors when more than 3 conductors are in a raceway.*

TABLE CONTINUED FROM PAGE 4

Model	SINGLE CIRCUIT						DUAL CIRCUIT							
	Rated Volts & Phase	No. Field Power Circuits	③	①	②	②	③		①		②		②	
			Minimum Circuit Ampacity	Maximum External Fuse or Circuit Breaker	Field Power Wire Size	Ground Wire Size	Minimum Circuit Ampacity	Maximum External Fuse or Circuit Breaker	Field Power Wire Size	Ground Wire Size	Field Power Wire Size	Ground Wire Size	Field Power Wire Size	Ground Wire Size
			CKT A	CKT B	CKT A	CKT B	CKT A	CKT B	CKT A	CKT B	CKT A	CKT B	CKT A	CKT B
WA602-A00, A0Z A05 A10 A15 A20	230/208-1	1 1 1 1 or 2 1 or 2	44 44 55 85 110	60 60 60 90 110	8 8 6 4 2	10 10 10 8 6	N/A N/A N/A 59 59	N/A N/A N/A 26 52	N/A N/A N/A 60 60	N/A N/A N/A 30 60	N/A N/A N/A 6 6	N/A N/A N/A 10 6	N/A N/A N/A 10 10	N/A N/A N/A 10 10
WA602-B00, B0Z B09 B15 B18	230/208-3	1 1 1 1	32 34 52 60	45 45 60 60	8 8 6 6	10 10 10 10	N/A N/A N/A N/A	N/A N/A N/A N/A	N/A N/A N/A N/A	N/A N/A N/A N/A	N/A N/A N/A N/A	N/A N/A N/A N/A	N/A N/A N/A N/A	N/A N/A N/A N/A
WA602-C00, C0Z C09 C15	460-3	1 1 1	16 17 26	20 20 30	12 12 10	12 12 10	N/A N/A N/A	N/A N/A N/A	N/A N/A N/A	N/A N/A N/A	N/A N/A N/A	N/A N/A N/A	N/A N/A N/A	N/A N/A N/A

- ① Maximum size of the time delay fuse or HACR type circuit breaker for protection of field wiring conductors.
- ② Based on 75° C copper wire. All wiring must conform to NEC and all local codes.
- ③ These "Minimum Circuit Ampacity" values are to be used for sizing the field power conductors. Refer to the National Electric Code (latest revision), article 310 for power conductor sizing. *CAUTION: When more than one field power conductor circuit is run through one conduit, the conductors must be derated. Pay special attention to note 8 of table 310 regarding Ampacity Adjustment Factors when more than 3 conductors are in a raceway.*

SHIPPING DAMAGE

Upon receipt of equipment, the carton should be checked for external signs of shipping damage. If damage is found, the receiving party must contact the last carrier immediately, preferably in writing, requesting inspection by the carrier's agent.

GENERAL

The equipment covered in this manual is to be installed by trained, experienced service and installation technicians.

The refrigerant system is completely assembled and charged. All internal wiring is complete.

The unit is designed for use with or without duct work. Flanges are provided for attaching the supply and return ducts.

These instructions explain the recommended method to install the air cooled self-contained unit and the electrical wiring connections to the unit.

These instructions and any instructions packaged with any separate equipment required to make up the entire air conditioning system should be carefully read before beginning the installation. Note particularly "Starting Procedure" and any tags and/or labels attached to the equipment.

While these instructions are intended as a general recommended guide, they do not supersede any national and/or local codes in any way. Authorities having jurisdiction should be consulted before the installation is made. See Page 1 for information on codes and standards.

Size of unit for a proposed installation should be based on heat loss calculation made according to methods of Air Conditioning Contractors of America (ACCA). The air duct should be installed in accordance with the Standards of the National Fire Protection Association for the Installation of Air Conditioning and Ventilating Systems of Other Than Residence Type, NFPA No. 90A, and Residence Type Warm Air Heating and Air Conditioning Systems, NFPA No. 90B. Where local regulations are at a variance with instructions, installer should adhere to local codes.

DUCT WORK

All duct work, supply and return, must be properly sized for the design air flow requirement of the equipment. Air Conditioning Contractors of America (ACCA) is an excellent guide to proper sizing. All duct work or portions thereof not in the conditioned space should be properly insulated in order to both conserve energy and prevent condensation or moisture damage.

Refer to Table 10 for maximum static pressure available for duct design.

Design the duct work according to methods given by the Air Conditioning Contractors of America (ACCA). When duct runs through unheated spaces, it should be insulated with a minimum of one inch of insulation. Use insulation with a vapor barrier on the outside of the insulation. Flexible joints should be used to connect the duct work to the equipment in order to keep the noise transmission to a minimum.

A 1/4 inch clearance to combustible material for the first three feet of duct attached to the outlet air frame is required. See Wall Mounting Instructions and Figures 3 and 4 for further details.

Ducts through the walls must be insulated and all joints taped or sealed to prevent air or moisture entering the wall cavity.

Some installations may not require any return air duct. A metallic return air grille is required with installations not requiring a return air duct. The spacing between louvers on the grille shall not be larger than 5/8 inch.

Any grille that meets with 5/8 inch louver criteria may be used. It is recommended that Bard Return Air Grille Kit RG2 through RG5 or RFG2 through RFG5 be installed when no return duct is used. Contact distributor or factory for ordering information. If using a return air filter grille, filters must be of sufficient size to allow a maximum velocity of 400 fpm.

NOTE: If no return air duct is used, applicable installation codes may limit this cabinet to installation only in a single story structure.

FILTERS

A one inch throwaway filter is supplied with each unit. The filter slides into position making it easy to service. This filter can be serviced from the outside by removing the service door. A one inch washable filter and two inch pleated filter are also available as optional accessories. The internal filter brackets are adjustable to accommodate the two inch filter by loosening two (2) screws on each bracket assembly and sliding the brackets apart to the required width and retightening the four (4) screws.

FRESH AIR INTAKE

All units are built with fresh air inlet slots punched in the service panel.

If the unit is equipped with a fresh air damper assembly, the assembly is shipped already attached to the unit. The damper blade is locked in the closed position. To allow the damper to operate, the maximum and minimum blade position stops must be installed. See Figure 2.

All capacity, efficiency and cost of operation information as required for Department of Energy "Energyguide" Fact Sheets is based upon the fresh air blank-off plate in place and is recommended for maximum energy efficiency.

The blank-off plate is available upon request from the factory and is installed in place of the fresh air damper shipped with each unit.

CONDENSATE DRAIN

A plastic drain hose extends from the drain pan at the top of the unit down to the unit base. There are openings in the unit base for the drain hose to pass through. In the event the drain hose is connected to a drain system of some type, it must be an open or vented type system to assure proper drainage.

**FIGURE 2
FRESH AIR DAMPER**

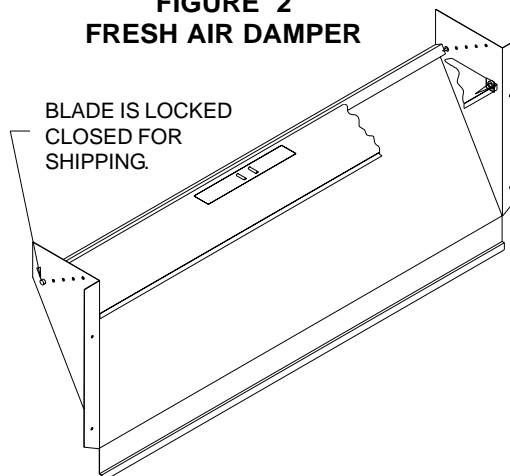

MIS-938

INSTALLATION INSTRUCTIONS

WALL MOUNTING INFORMATION

1. Two holes for the supply and return air openings must be cut through the wall as shown in Figure 3.
2. On wood frame walls, the wall construction must be strong and rigid enough to carry the weight of the unit without transmitting any unit vibration.
3. Concrete block walls must be thoroughly inspected to insure that they are capable of carrying the weight of the installed unit.

MOUNTING THE UNIT

1. These units are secured by wall mounting brackets which secure the unit to the outside wall surface at both sides. A bottom mounting bracket is provided for ease of installation, but is not required.
2. The unit itself is suitable for 0 inch clearance, but the supply air duct flange and the first 3 feet of supply air duct require a minimum of 1/4 inch clearance to combustible material. If a combustible wall use a minimum of 30-1/2" x 10-1/2" dimensions for sizing. However it is generally recommended that a 1 inch clearance is used for ease of installation and maintaining the required clearance to combustible material. The supply air opening would then be 32" x 12". See Figures 3 and 4 for details.
3. Locate and mark lag bolt locations and bottom mounting bracket location. See Figure 3.

WARNING

Failure to provide the 1/4 inch clearance between the supply duct and a combustible surface for the first 3 feet of duct can result in fire causing damage, injury or death.

4. Mount bottom mounting bracket.
5. Hook top rain flashing under back bend of top. Top rain flashing is shipped secured to the right side of the back.
6. Position unit in opening and secure with 5/16 lag bolts; use 7/8 inch diameter flat washers on the lag bolts.
7. Secure rain flashing to wall and caulk across entire length of top. See Figure 3.
8. For additional mounting rigidity, the return air and supply air frames or collars can be drilled and screwed or welded to the structural wall itself (depending upon wall construction). Be sure to observe required clearance if combustible wall.
9. On side by side installations, maintain a minimum of 20 inches clearance on right side to allow access to control panel and heat strips, and to allow proper airflow to the outdoor coil. Additional clearance may be required to meet local or national codes.

**FIGURE 3
MOUNTING INSTRUCTIONS**

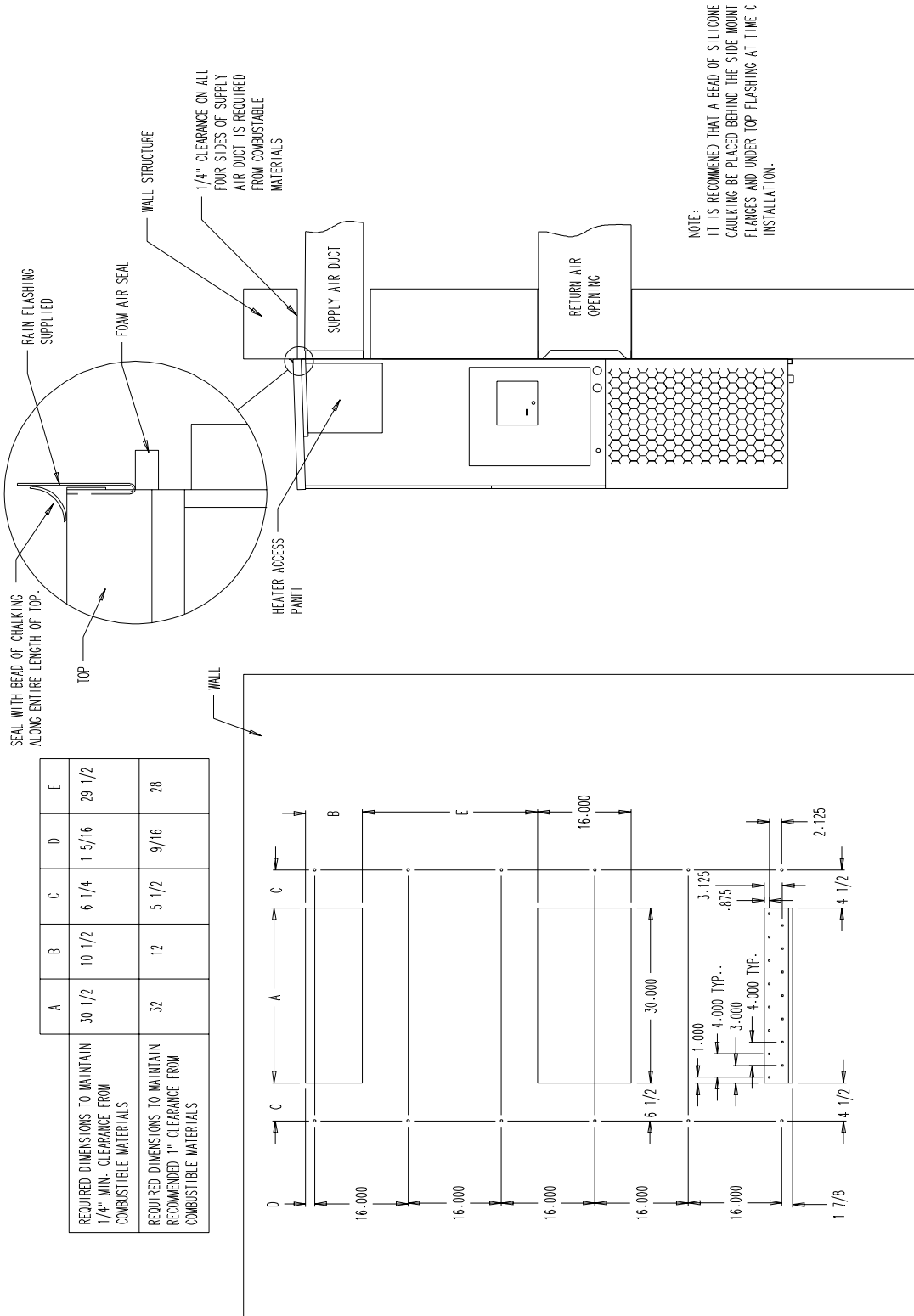

**FIGURE 4
ELECTRIC HEAT CLEARANCE**

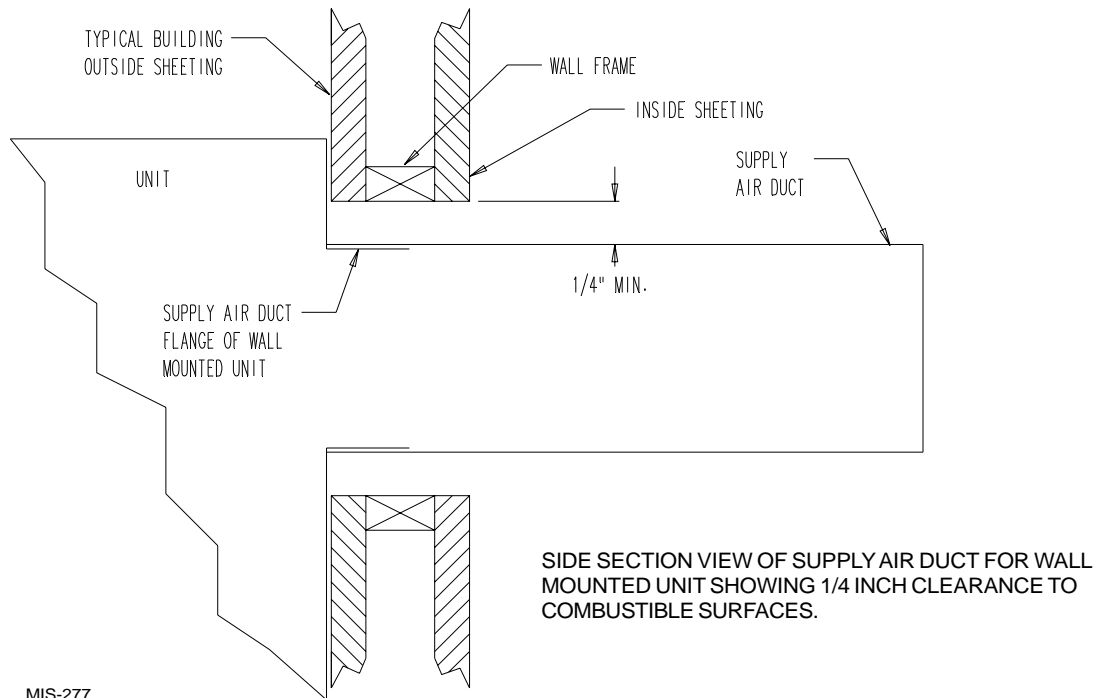

MIS-277



WARNING

*A **minimum** of 1/4 inch clearance must be maintained between the supply air duct and combustible materials. This is required for the first 3 feet of ducting.*

It is important to insure that the 1/4 inch minimum spacing is maintained at all points.

Failure to do this could result in overheating the combustible material and may result in a fire causing damage, injury or death.

FIGURE 5 WALL MOUNTING INSTRUCTIONS

SEE FIGURE 3 – MOUNTING INSTRUCTIONS

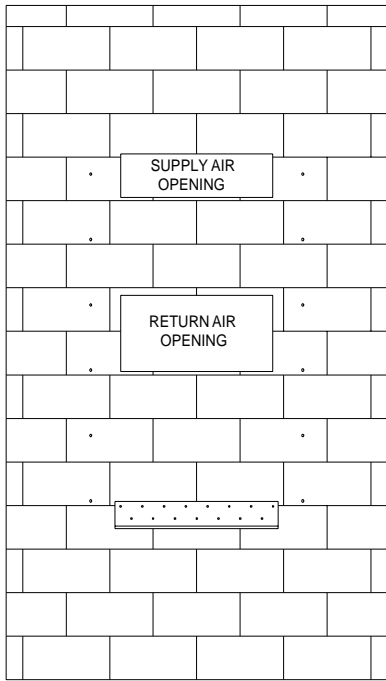

CONCRETE BLOCK WALL INSTALLATION

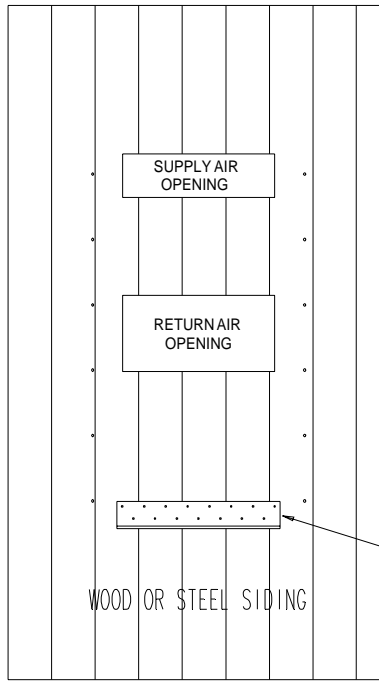

WOOD FRAME WALL INSTALLATION

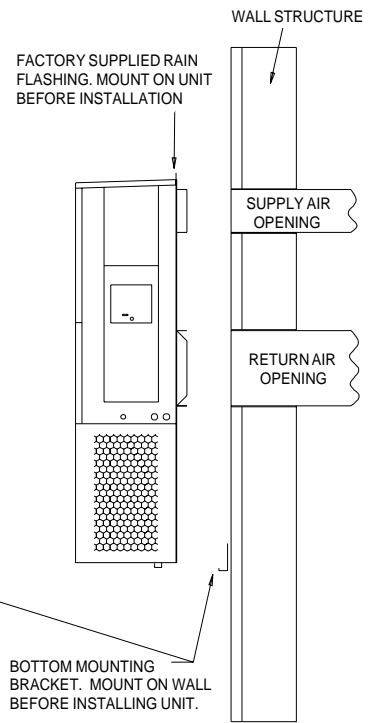

MIS-548

FIGURE 6 WALL MOUNTING INSTRUCTIONS

SEE UNIT DIMENSIONS, FIGURE 1, FOR ACTUAL DIMENSIONS

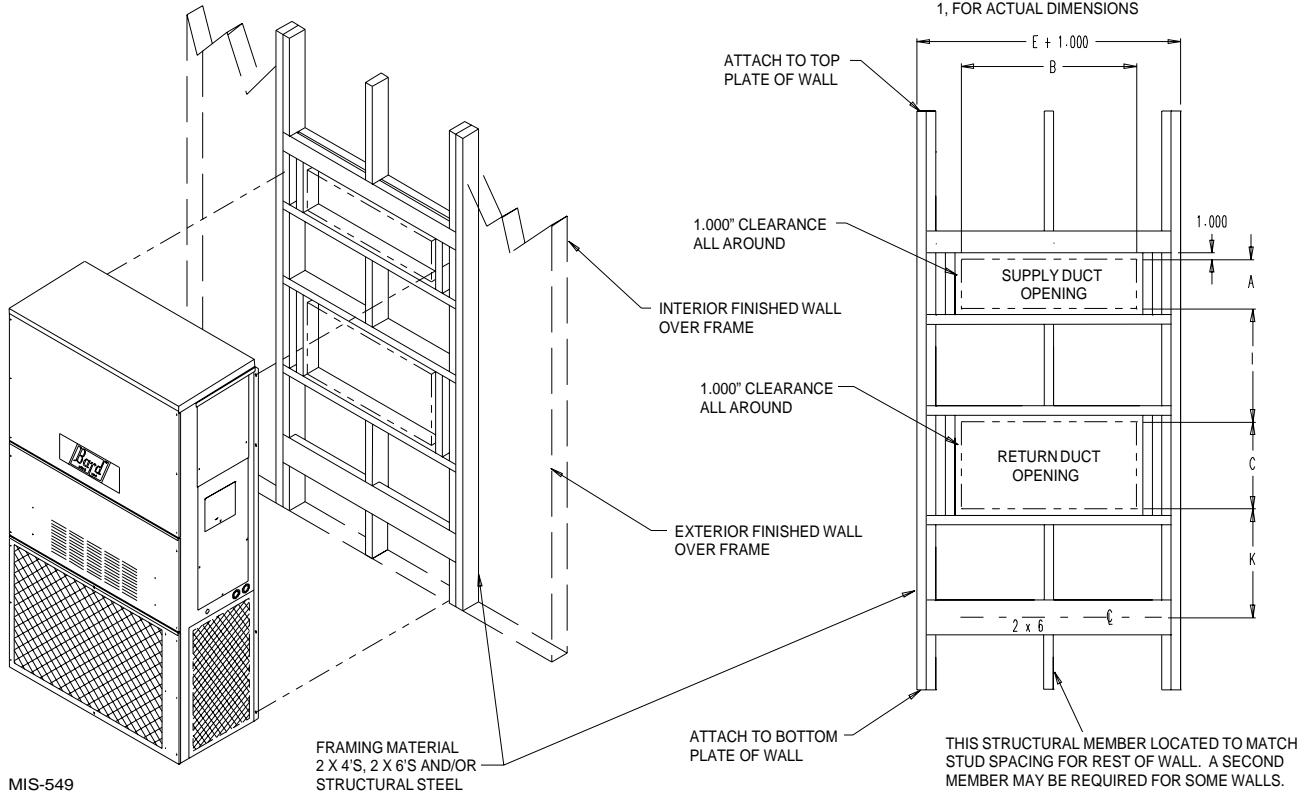

MIS-549

**FIGURE 7
COMMON WALL MOUNTING INSTALLATIONS**

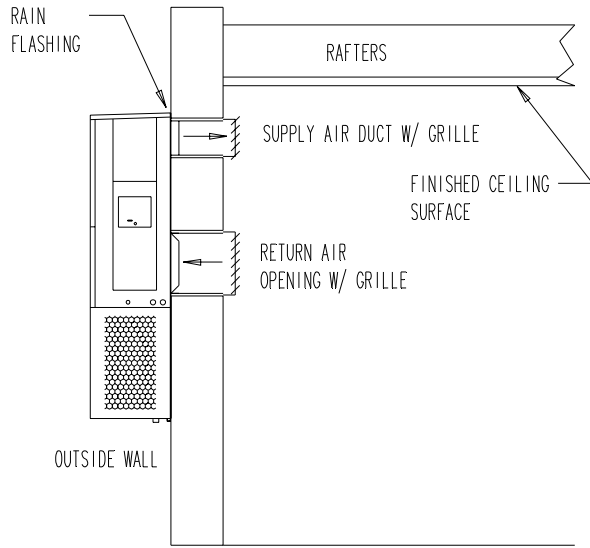

FREE AIR FLOW NO DUCT

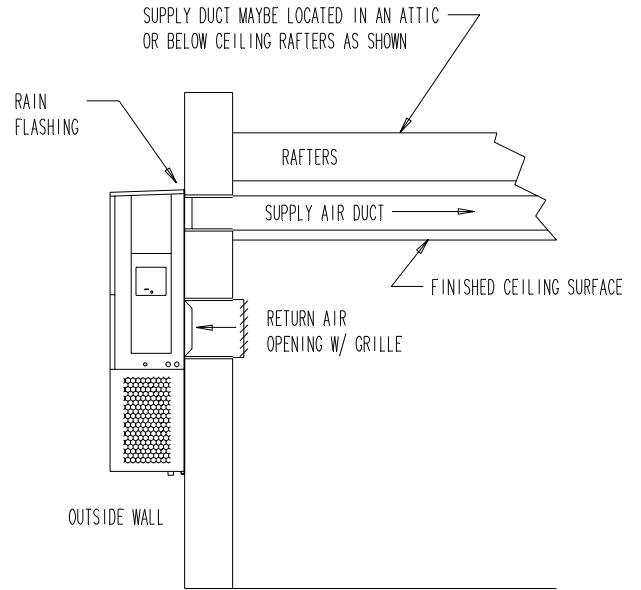

DUCTED SUPPLY RETURN AT UNIT

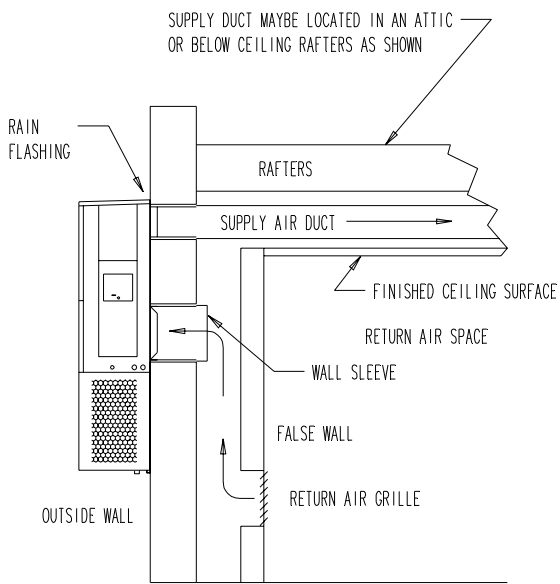

FALSE WALL INSTALLATION

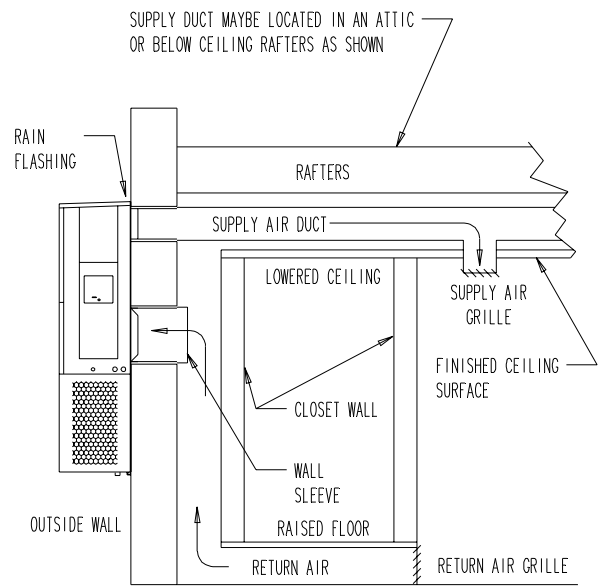

CLOSET INSTALLATION

WIRING – MAIN POWER

Refer to the unit rating plate for wire sizing information and maximum fuse or “HACR” type circuit breaker size. Each outdoor unit is marked with a “Minimum Circuit Ampacity”. This means that the field wiring used must be sized to carry that amount of current. Depending on the installed KW of electric heat, there may be two field power circuits required. If this is the case, the unit serial plate will so indicate. All models are suitable only for connection with copper wire. Each unit and/or wiring diagram will be marked “Use Copper Conductors Only”. These instructions **must be** adhered to. Refer to the National Electrical Code (NEC) for complete current carrying capacity data on the various insulation grades of wiring material. All wiring must conform to NEC and all local codes.

The electrical data lists fuse and wire sizes (75° C copper) for all models including the most commonly used heater sizes. Also shown are the number of field power circuits required for the various models with heaters.

The unit rating plate lists a “Maximum Time Delay Relay Fuse” or “HACR” type circuit breaker that is to be used with the equipment. The correct size must be used for proper circuit protection and also to assure that there will be no nuisance tripping due to the momentary high starting current of the compressor motor.

The disconnect access door on this unit may be locked to prevent unauthorized access to the disconnect. To convert for the locking capability bend the tab located in the bottom left hand corner of the disconnect opening under the disconnect access panel straight out. This tab will now line up with the slot in the door. When shut a padlock may be placed through the hole in the tab preventing entry.

See “Start Up” section for important information on three phase scroll compressor start ups.

WIRING – LOW VOLTAGE WIRING

230 / 208V, 1 phase and 3 phase equipment dual primary voltage transformers. All equipment leaves the factory wired on 240V tap. For 208V operation, reconnect from 240V to 208V tap. The acceptable operating voltage range for the 240 and 208V taps are:

TAP	RANGE
240	253 – 216
208	220 – 187

NOTE: The voltage should be measured at the field power connection point in the unit and while the unit is operating at full load (maximum amperage operating condition).

Five (5) wires should be run from thermostat subbase to the 24V terminal board in the unit. A five conductor, 18 gauge copper, color-coded thermostat cable is recommended. The connection points are shown in Figure 8:

**TABLE 3
THERMOSTAT WIRE SIZE**

Transformer VA	FLA	Wire Gauge	Maximum Distance In Feet
55	2.3	20 gauge	45
		18 gauge	60
		16 gauge	100
		14 gauge	160
		12 gauge	250

**TABLE 4
WALL THERMOSTAT AND SUBBASE COMBINATIONS**

Thermostat	Subbase	Predominate Features
8403-002 T87F3111	8404-003 Q539A1220	1 stage heat, 1 stage cool System: heat-off-cool Fan: auto-on
8403-041 T8034C	---	1 stage heat, 1 stage cool System: heat-off-cool Fan: auto-on
8403-019 T874C1760	8404-012 Q674A1001	1 stage cool, 2 stage heat System: heat-auto-cool Fan: auto-on
8403-021 T874D1934	8404-012 Q674A1001	2 stage cool, 2 stage heat System: heat-auto-cool Fan: auto-on
8403-035 1F95-80	---	2 stage cool, 2 stage heat Electronic 7 day programming
8403-043 CM-200	---	1 stage heat, 1 stage cool System: heat-off-cool Fan: auto-on

**FIGURE 8
UNIT 24V TERMINAL BOARD**

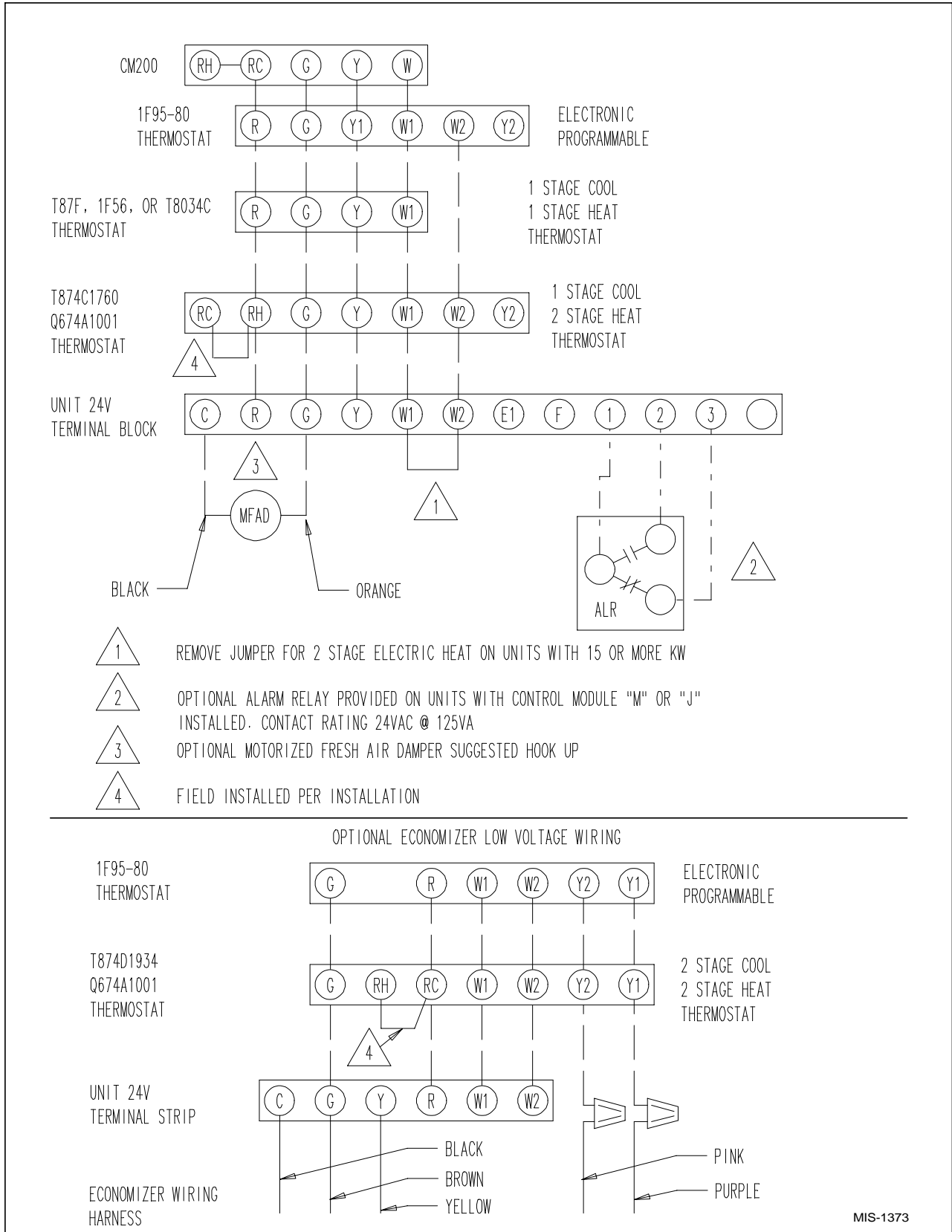

MIS-1373

START UP

IMPORTANT INSTALLER NOTE

For improved start up performance wash the indoor coil with a dish washing detergent.

CRANKCASE HEATERS

WA421 units are provided with compressor crankcase heat. The other units are not provided with crankcase heat. These units utilize scroll compressors which do not require crankcase heat in this application.

The WA421 models have an insertion well-type heater located in the lower section of the compressor housing. This is a self-regulating type heater that draws only enough power to maintain the compressor at a safe temperature on these units.

Some form of crankcase heat is essential to prevent liquid refrigerant from migrating to the compressor causing oil pump out on compressor start up and possible valve failure due to compressing a liquid.

The decal in Figure 9 is affixed to all WA421 units detailing start up procedure. This is very important. Please read carefully.

HIGH PRESSURE SWITCH

The WA381, WA482, WA491 and WA602 models are supplied with a remote reset high pressure switch. If tripped, this pressure switch may be reset by turning the thermostat off then back on again.

THREE PHASE SCROLL COMPRESSOR START UP INFORMATION

Scroll compressors, like several other types of compressors, will only compress in one rotational direction. Direction of rotation is not an issue with single phase compressors since they will always start and run in the proper direction.

However, three phase compressors will rotate in either direction depending upon phasing of the power. Since there is a 50-50 chance of connecting power in such a way as to cause rotation in the reverse direction, verification of proper rotation must be made.

Verification of proper rotation direction is made by observing that suction pressure drops and discharge pressure rises when the compressor is energized. Reverse rotation also results in an elevated sound level over that with correct rotation, as well as, substantially reduced current draw compared to tabulated values.

Verification of *proper rotation* must be made at the time the equipment is put into service. If improper rotation is corrected at this time there will be no negative impact on the durability of the compressor. However, reverse operation for over one hour may have a negative impact on the bearing due to oil pump out.

FIGURE 9
STARTING PROCEDURE

IMPORTANT

THESE PROCEDURES MUST BE FOLLOWED AT INITIAL START UP AND AT ANY TIME POWER HAS BEEN REMOVED FOR 12 HOURS OR LONGER.

To prevent compressor damage which may result from the presence of liquid refrigerant in the compressor crankcase.

- 1. Make certain the room thermostat is in the "off" position (the compressor is not to operate).*
- 2. Apply power by closing the system disconnect switch. This energizes the compressor heater which evaporates the liquid refrigerant in the crankcase.*
- 3. Allow 4 hours or 60 minutes per pound of refrigerant in the system as noted on the unit rating plate, which ever is greater.*
- 4. After properly elapsed time, the thermostat may be set to operate the compressor.*
- 5. Except as required for safety while servicing, **Do not open system disconnect switch.***

7961-061

NOTE: If compressor is allowed to run in reverse rotation for several minutes, the compressor's internal protector will trip.

All three phase ZR compressors are wired identically internally. As a result, once the correct phasing is determined for a specific system or installation, connecting properly phased power leads to the same Fusite terminal should maintain proper rotation direction.

The direction of rotation of the compressor may be changed by reversing any two line connections to the unit.

CONDENSER FAN OPERATION

The condenser fan motor on 230/208 volt, one and three phase, 60 HZ units is a two speed motor that comes factory wired on high speed for peak performance. If ambient conditions permit, it can be reconnected to low speed (red wire) for lower sound level. See wiring diagram.

50 HZ models must have fan wired on low speed. These models are factory wired on low speed.

SERVICE HINTS

1. Caution homeowner to maintain clean air filters at all times. Also, not to needlessly close off supply and return air registers. This reduces air flow through the system, which shortens equipment service life as well as increasing operating costs.
2. Switching to heating cycle at 75° F or higher outside temperature may cause a nuisance trip of the remote reset high pressure switch. Turn thermostat off then on to reset the high pressure switch.
3. Check all power fuses or circuit breakers to be sure they are the correct rating.
4. Periodic cleaning of the outdoor coil to permit full and unrestricted airflow circulation is essential.

SEQUENCE OF OPERATION

COOLING – Circuit R-Y makes at thermostat pulling in compressor contactor, starting the compressor and outdoor motor. The G (indoor motor) circuit is automatically completed on any call for cooling operation or can be energized by manual fan switch on subbase of constant air circulation. On all 230 volt units there is a one minute off delay on the blower motor. 460 volt models do not have an off delay. On a call for heating, circuit R-W1 make at the thermostat pulling in heat contact for the strip heat and blower operation. On a call for second stage heat, R-W2 makes bringing on second heat contactor, if so equipped.

COMPRESSOR CONTROL MODULE

The compressor control module is standard on the WA391, WA482, WA491 and WA602 models covered by this manual and is optional on the WA421 model. The compressor control is an anti-short cycle/lockout timer with high and low pressure switch monitoring and alarm relay output.

Adjustable Delay On Make And Break Timer

On initial power up or any time power is interrupted to the unit the *delay on make* period begins which will be 2 minutes plus 10% of the *delay on break* setting. When the delay on make is complete and the high pressure switch (and low pressure switch if employed) is closed, the compressor contactor is energized. Upon shutdown the delay or break timer starts and prevents restart until the delay on break and delay on make periods have expired.

During routine operation of the unit with no power interruptions the compressor will operate on demand with no delay.

High Pressure Switch and Lockout Sequence

If the high pressure switch opens, the compressor contactor will de-energize immediately. The lockout

timer will go into a *soft lockout* and stay in soft lockout until the high pressure switch closes and the delay on break time has expired. If the high pressure switch opens again in this same operating cycle the unit will go into *manual lockout* condition and the alarm relay circuit will energize. Recycling the wall thermostat resets the manual lockout.

Low Pressure Switch, Bypass, and Lockout Sequence

If the low pressure switch opens for more than 120 seconds, the compressor contactor will de-energize and go into a soft lockout. Regardless the state of the low pressure switch, the contactor will reenergize after the delay on make time delay has expired. If the low pressure switch remains open, or opens again for longer than 120 seconds the unit will go into manual lockout condition and the alarm relay circuit will energize. Recycling the wall thermostat resets the manual lockout.

Alarm Relay Output

Alarm terminal is output connection for applications where alarm relay is employed. This terminal is powered whenever compressor is locked out due to HPC or LPC sequences as described.

NOTE: Both high and low pressure switch controls are inherently automatic reset devices. The high pressure switch and low pressure switch cut out and cut in settings are fixed by specific air conditioner or heat pump unit model. The lockout features, both soft and manual, are a function of the Compressor Control Module.

ADJUSTMENTS

Adjustable Delay on Make and Delay on Break Timer

The potentiometer is used to select Delay on Break time from 30 seconds to 5 minutes. Delay on Make (DOM) timing on power-up and after power interruptions is equal to 2 minutes plus 10% of Delay on Break (DOB) setting:

0.5 minute (30 seconds)	DOB = 123 second	DOM
1.0 minute (60 seconds)	DOB = 126 second	DOM
2.0 minute (120 seconds)	DOB = 132 second	DOM
3.0 minute (180 seconds)	DOB = 138 second	DOM
4.0 minute (240 seconds)	DOB = 144 second	DOM
5.0 minute (300 seconds)	DOB = 150 second	DOM

During routine operation of the unit with no power interruptions the compressor will operate on demand with no delay.

Typical Settings for Dual Unit Installation:

- Unit 1: DOB set at 2 minutes, and DOM is 132 seconds
Unit 2: DOB set at 4 minutes, and DOM is 144 seconds

PHASE MONITOR

All units with three phase scroll compressors are equipped with a 3 phase line monitor to prevent compressor damage due to phase reversal.

The phase monitor in this unit is equipped with two LEDs. If the Y signal is present at the phase monitor and phases are correct the green LED will light.

If phases are reversed, the red fault LED will be lit and compressor operation is inhibited.

If a fault condition occurs, reverse two of the supply leads to the unit. Do not reverse any of the unit factory wires as damage may occur.

PRESSURE SERVICE PORTS

High and low pressure service ports are installed on all units so that the system operating pressures can be observed. A pressure table can be found later in the manual covering all models. It is imperative to match the correct pressure table to the unit by model number.

TROUBLESHOOTING

FAN BLADE SETTING DIMENSIONS

Shown in Figure 10 is the correct fan blade setting dimension for proper air delivery across the outdoor coil.

Any service work requiring removal or adjustment in the fan and/or motor area will require that the dimensions below be checked and blade adjusted in or out on the motor shaft accordingly.

**FIGURE 10
FAN BLADE SETTING**

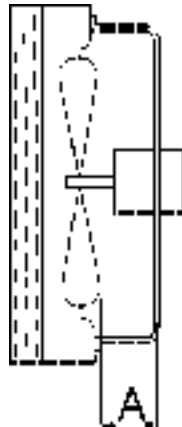

**TABLE 5
FAN BLADE DIMENSION**

Model	Dimension A
WA381 WA421 WA482 WA491 WA602	1.75

- Unwire condenser fan motor.
- Slide complete motor, fan blade, and shroud assembly out the left side of the unit.
- Service motor/fan as needed.
- Reverse steps to reinstall.

REFRIGERANT CHARGE

The correct system R-22 charge is shown on the unit rating plate. Optimum unit performance will occur with a refrigerant charge resulting in a suction line temperature (6" from compressor) as shown in Table 6.

**TABLE 6
REFRIGERANT CHARGE**

Model	Rated Airflow	95 OD Temperature	82 OD Temperature
WA381	1100	50 - 48	48 - 46
WA421	1400	52 - 54	64 - 66
WA482	1550	54 - 56	65 - 67
WA491	1250	48 - 46	47 - 45
WA602	1700	53 - 55	60 - 62

REMOVAL OF FAN SHROUD

- Disconnect all power to the unit.
- Remove the screws holding both grilles, one on each side of unit, and remove grilles.
- Remove screws holding fan shroud to condenser and bottom. Nine (9) screws.

The suction line temperatures in table above are based upon 80° F dry bulb / 67° F wet bulb (50% R.H.) temperature and rated airflow across the evaporator during cooling cycle.

**TABLE 7
INDOOR BLOWER PERFORMANCE
CFM @ 230V**

E.S.P. In H ₂ O	WA421, WA482				WA602			
	Low 230V		High 230V		Low 230V		High 230V	
	Dry Coil	Wet Coil	Dry Coil	Wet Coil	Dry Coil	Wet Coil	Dry Coil	Wet Coil
.0	1650	1600	1885	1800	1600	1450	2200	2000
.1	1550	1500	1770	1665	1525	1375	2100	1900
.2	1450	1400	1635	1540			2000	1800
.3	1350	1300	1500	1400			1875	1700
.4	1300	1175	1370	1285			1775	1600
.5	---	---	1250	1150			1650	1475

Table 7A on Page 18 for models WA381 and WA491

**TABLE 7A
INDOOR BLOWER PERFORMANCE
CFM @ 230V / 460V**

E.S.P. In H ₂ O	WA381						WA491			
	High Speed		Medium Speed		Low Speed		High Speed		Medium Speed	
	Dry Coil	Wet Coil	Dry Coil	Wet Coil	Dry Coil	Wet Coil	Dry Coil	Wet Coil	Dry Coil	Wet Coil
.0	1625	1475	1425	1325	1125	1100	1700	1550	1475	1375
.1	1475	1350	1325	1200	1100	1000	1550	1400	1375	1250
.2	1350	1150	1200	125	1000	850	1400	1250	1250	1100
.3	1150	825	1025	875	825	675	1250	1100	1100	825
.4	825	750					900	800		

**TABLE 8
RECOMMENDED AIRFLOW**

Model	Rated CFM *	Rated ESP *	Recommended Airflow Range
WA381	1100	.15	1250 - 850
WA421	1400	.30	1600 - 1150
WA482	1550	.20	1750 - 1285
WA491	1250	.20	1475 - 850
WA602	1700	.30	1950 - 1375

* Rated CFM and ESP on high speed tap.

**TABLE 9
MAXIMUM ESP OF OPERATION
ELECTRIC HEAT ONLY**

Model	WA421		WA482		WA602	
	High Speed	Low Speed	High Speed	Low Speed	High Speed	Low Speed
-A05	.50	.50	.50	.50	.50	.50
-A10	.50	.50	.50	.50	.50	.50
-A15	.50	.50	.50	.50	.50	.50
-A20	.50	.45	.50	.45	.50	.40
-B00	.50	.50	.50	.50	.50	.50
-B09	.50	.50	.50	.50	.50	.50
-B15	.50	.50	.50	.50	.50	.50
-B18	.50	.50	.50	.50	.50	.50
-C09	.50	.50	.50	.50	.50	.50
-C15	.50	.50	.50	.50	.50	.50

Values shown are for units equipped with standard 1 inch throwaway filter or 1 inch washable filter. Derate ESP by .15 for 2 inch pleated filters.

**TABLE 9A
MAXIMUM ESP OF OPERATION
ELECTRIC HEAT ONLY**

Model	WA381			WA491	
	High Speed	Med Speed	Low Speed	High Speed	Med Speed
-A05	.30	.30	.30	.30	.30
-A08	.30	.30	.30	.40	.40
-A10	.30	.30	.20	.30	.30
-B06	.40	.30	.30	.30	.30
-B09	.40	.30	.30	.30	.30
-C06	.30	.30	.30	.30	.30
-C09	.30	.30	.30	.30	.30

Values shown are for units equipped with standard 1 inch throwaway filter or 1 inch washable filter. Derate ESP by .15 for 2 inch pleated filters.

**TABLE 10
PRESSURE TABLE**

COOLING

AIR TEMPERATURE ENTERING OUTDOOR COIL °F

Model	Return Air Temperature	Pressure	75	80	85	90	95	100	105	110	115
WA381	75 deg. DB 62 deg. WB	Low Side High Side	74 175	74 187	75 202	76 216	78 232	79 249	79 265	80 284	81 302
	80 deg. DB 67 deg. WB	Low Side High Side	79 179	79 192	80 207	81 222	83 238	84 255	85 272	86 291	87 310
	85 deg. DB 72 deg. WB	Low Side High Side	82 185	82 199	83 214	84 230	86 246	87 264	88 282	89 301	90 321
WA421	75 deg. DB 62 deg. WB	Low Side High Side	68 213	71 228	74 243	76 259	78 274	80 290	81 305	83 321	84 337
	80 deg. DB 67 deg. WB	Low Side High Side	72 218	76 234	79 249	82 265	84 281	86 297	88 313	89 330	90 346
	85 deg. DB 72 deg. WB	Low Side High Side	78 226	82 242	85 258	88 274	90 290	92 307	94 323	96 341	97 358
WA482	75 deg. DB 62 deg. WB	Low Side High Side	73 204	74 217	76 232	78 248	79 265	80 284	82 304	83 325	84 348
	80 deg. DB 67 deg. WB	Low Side High Side	78 210	79 223	81 238	82 254	84 272	86 291	87 312	89 334	90 357
	85 deg. DB 72 deg. WB	Low Side High Side	84 217	85 231	87 247	88 264	90 282	92 302	93 323	95 345	97 369
WA491	75 deg. DB 62 deg. WB	Low Side High Side	70 199	71 213	71 227	72 244	73 260	75 279	76 298	77 320	79 341
	80 deg. DB 67 deg. WB	Low Side High Side	75 204	76 218	76 233	77 250	78 267	80 286	81 306	82 328	84 350
	85 deg. DB 72 deg. WB	Low Side High Side	78 211	79 226	79 241	80 259	81 276	83 296	84 317	85 339	87 362
WA602	75 deg. DB 62 deg. WB	Low Side High Side	71 233	72 247	74 262	75 278	76 295	77 313	78 331	78 351	79 371
	80 deg. DB 67 deg. WB	Low Side High Side	76 237	78 253	79 269	80 285	81 303	82 321	83 340	84 390	85 381
	85 deg. DB 72 deg. WB	Low Side High Side	84 245	85 261	85 278	86 296	87 314	88 333	89 353	90 373	91 394

Low side pressure ± 2 PSIG
High side pressure ± 5 PSIG

Tables are based upon rated CFM (airflow) across the evaporator coil. If there is any doubt as to correct operating charge being in the system, the charge should be removed, system evacuated and recharged to serial plate instructions.

NOTE: Pressure table based on high speed condenser fan operation. If condensing pressures appear elevated check condenser fan wiring. See "Condenser Fan Operation" on Page 14.

**TABLE 11
OPTIONAL ACCESSORIES**

Part Number	Description	WA381-A	WA381-B	WA381-C	WA421-A	WA421-B	WA421-C	WA482-A	WA482-B	WA482-C	WA491-A	WA491-B	WA491-C	WA602-A	WA602-B	WA602-C
EHWA05-A05	Heater Packages				X			X						X		
EHWA05-A08	Heater Packages				X			X						X		
EHWA05-A10	Heater Packages				X			X						X		
EHWA05-A15	Heater Packages				X			X						X		
EHWA38-A05	Heater Packages	X								X						
EHWA38-A08	Heater Packages	X								X						
EHWA38-A10	Heater Packages	X														
EHWA49-A05	Heater Packages										X					
EHWA05-B09	Heater Packages					X			X						X	
EHWA05-B15	Heater Packages					X			X						X	
EHWA05-B18	Heater Packages					X			X						X	
EHWA38-B06	Heater Packages		X													
EHWA38-B09	Heater Packages		X													
EHWA49-B06	Heater Packages											X				
EHWA05-C09A	Heater Packages			X			X			X			X			X
EHWA05-C15	Heater Packages						X			X						X
EHWA38-C06	Heater Packages		X													X
BOP-5	Blank Off Plate	X	X	X	X	X	X	X	X	X	X	X	X	X	X	X
BFAD-5	Barometric Fresh Air Damper	X	X	X	X	X	X	X	X	X	X	X	X	X	X	X
MFAD-5	Motorized Fresh Air Damper	X	X	X	X	X	X	X	X	X	X	X	X	X	X	X
CRV-5	Commercial Ventilator with Exhaust	X	X	X	X	X	X	X	X	X	X	X	X	X	X	X
EIFM-5	Economizer with Exhaust	X	X	X	X	X	X	X	X	X	X	X	X	X	X	X
WERV-A5B	Energy Recovery Ventilator	X	X		X	X		X	X		X	X		X	X	
WERV-C5B	Energy Recovery Ventilator			X			X			X			X			X
CMA-6	Low Ambient Control (LAC)	X	X	X	X	X	X	X	X		X	X	X	X	X	X
CMA-10	LPC + HPC + TDR				X	X	X									
CMA-13	LPC + HPC + TDR + LAC				X	X										
CMC-15	Start Kit	X			X			X			X			X		
CMA-16	Low Pressue Control	X	X	X				X	X	X	X	X	X	X	X	X
CMA-18	LPC + LAC	X	X	X				X	X	X	X	X	X	X	X	X
WMCB-05B	Circuit Breaker Kit					X			X							
WMCD-01C	Pull Disconnect Kit			X			X			X			X			X
WMCB-08A	Circuit Breaker				X			X			X					
WMCB-09A	Circuit Breaker													X		
WMCB-07B	Circuit Breaker														X	
WMCB-05A	Circuit Breaker	X														
WMCB-04B	Circuit Breaker		X													
WMCB-06B	Circuit Breaker											X				