

# **INSTALLATION INSTRUCTIONS**

## **SPLIT AIR CONDITIONER OUTDOOR SECTION**

### **MODELS:**

**HAC181-A**

**HAC241-A**

**HAC301-A**

**HAC361-A**

**FOR USE WITH:  
MATCHING INDOOR BLOWER  
COIL UNITS AND MATCHING  
ADD ON COIL UNITS ONLY**

**DATE: 03-01-94**

**MANUAL 2100-241  
SUPERSEDES REV.  
FILE VOL. I, TAB 4**

TABLE OF CONTENTS

I. Application and Location . . . . . 3  
  General . . . . . 3  
  Shipping Damage . . . . . 3  
  Application . . . . . 3  
  Location . . . . . 4  
  Mounting Unit Outside on Slab . . . . . 4  
  Important Installer Note . . . . . 4  
  Installing Refrigerant Tubing . . . . . 4  
  Sweat Style Tubing Connections: Sweat Indoor Unit & Sweat Outdoor Unit. 5  
  Field Fabricated Tubing Connections: Quick Connect Indoor Unit & Sweat. 7  
    Outdoor Unit Using CTO Kit

II. Wiring Instructions . . . . . 9  
  General . . . . . 9  
  Control Circuit Wiring . . . . . 9  
  Wall Thermostats . . . . . 13  
  Option Controls . . . . . 14  
  A. CMA-1 High Pressure Control . . . . . 15  
  B. CMA-2 Low Pressure Control. . . . . 16  
  C. CMA-4 High and Low Pressure Control . . . . . 17  
  D. CMA-5 Compressor Time Delay Relay . . . . . 18  
  E. CMA-6 Low Ambient Fan Cycling Control . . . . . 19  
  F. CMA-11 Dual Pressure & Low Ambient Fan Cycling Control. . . . . 20

III. Charging Instructions . . . . . 21  
  Pressure Service Ports . . . . . 21  
  System Start-Up (Indoor Units without Expansion Valves) . . . . . 22

IV. Service . . . . . 24  
  Service Hints . . . . . 24  
  Fan Blade Setting Dimensions . . . . . 24  
  Wiring Diagrams . . . . . 25  
  Pressure Tables . . . . . 26-27

## FIGURES AND TABLES

Figure 1 . . . . .	1
Figure 2 . . . . .	3
Figure 3 . . . . .	4
Figure 4 . . . . .	5
Figure 5 . . . . .	14
Figure 6 . . . . .	15
Figure 7 . . . . .	16
Figure 8 . . . . .	17
Figure 9 . . . . .	18
Figure 10. . . . .	19
Figure 11. . . . .	20
Figure 12. . . . .	21

Table 1 . . . . .	1
Table 2 . . . . .	2
Table 3 . . . . .	2
Table 3A . . . . .	6
Table 4 . . . . .	9
Table 5 . . . . .	10
Table 6 . . . . .	10
Table 7 . . . . .	13
Table 8 . . . . .	22
Table 9 . . . . .	22
Table 10 . . . . .	23
Table 11 . . . . .	24
Table 12 . . . . .	26
Table 13 . . . . .	26
Table 14 . . . . .	27
Table 15 . . . . .	27

FIGURE 1

NOMENCLATURE EXPLANATION - Example:

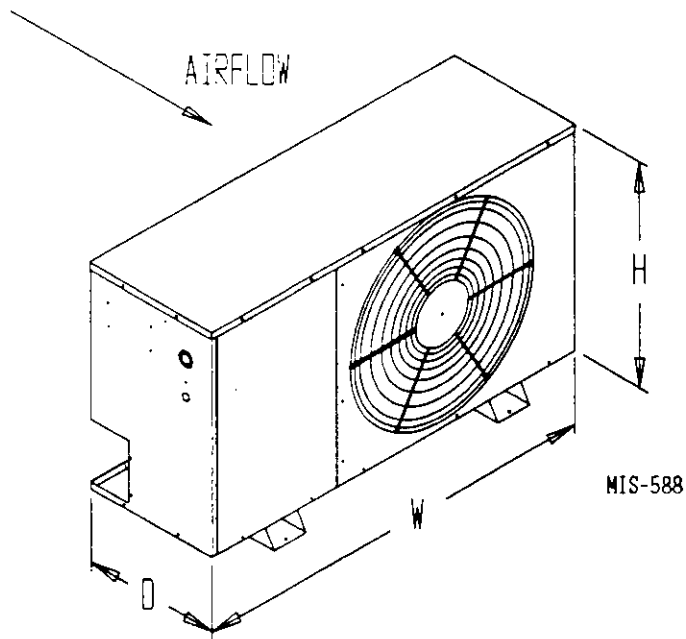
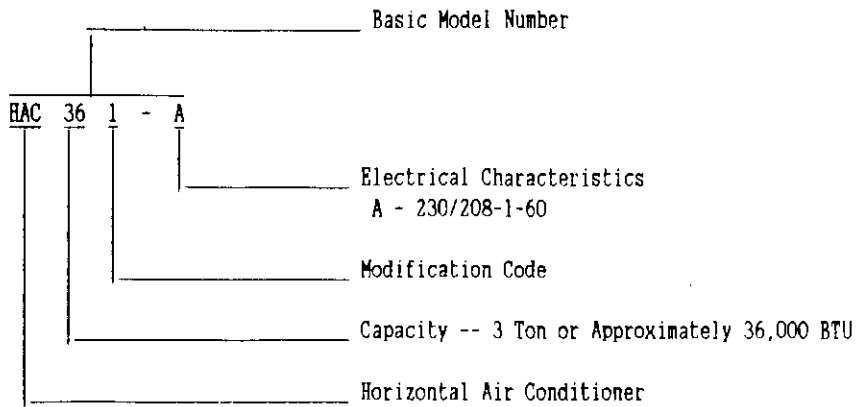

TABLE 1

DIMENSIONS			
Model No.	"W" Width	"D" Depth	"H" Height
HAC181 HAC241	40"	15"	26"
HAC301 HAC361	45"	15"	26"

TABLE 2 RATED CFM AND AIR FLOW DATA (WET COIL--COOLING)

Condensing Unit Model Number	Evaporator Coil Model Number	Rated Airflow		Rated E.S.P. (2)	Motor Speed Tap	Recommended Air Flow Range	System Orifice Required
		CFM	Pressure Drop H2O (1)				
HAC181-A	S24AS-A	650	.24	.35	Med	550 - 715	.052 *
	BC24B	650				550 - 715	.052 *
HAC241-A	S24AS-A	780	.30	.20	High	680 - 890	.055
	BC24B	800				700 - 910	.055 *
HAC301-A	A36AS-A	1000	.20	.30	Low	850 - 1175	.063 *
	BC36B	1000				850 - 1175	.063 *
HAC361-A	A37AS-A	1100	.18	.27	High	920 - 1220	.069 *
	BC36B	1100				920 - 1220	.069 *

(1) Measured across the evaporator coil assembly, including drain pan.  
 (2) External static pressure available for the duct system - supply and return. All blower coils have multi-speed motors, and value shown is at the recommended rated speed. Consult specification air flow charts with the blower coil units for complete information at other speeds.

\*IMPORTANT

Proper sized orifice is not factory installed in indoor section. Proper orifice size is shipped with outdoor unit packaged with its installation instructions for indoor sections listed on this page. The orifice must be replaced with the proper system orifice shown above in Table 2.

For other evaporator coil models not listed, see indoor coil installation instructions for proper orifice information.

TABLE 3

Model	HAC181-A	HAC241-A	HAC301-A	HAC361-A
Electrical Rating (60HZ/V/PH)	230/208-1	230/208-1	230/208-1	230/208-1
Operating Voltage Range	197-253	197-253	197-253	197-253
Minimum Circuit Ampacity	15	15	19	20
+ Field Wire Size	#14	#14	#12	#12
++ Delay Fuse Maximum or Circuit Breaker	20	20	30	30
Total Unit Amps 230/208	7.9/8.6	10.2/11.4	13.4/14.0	14.5/15.8
Compressor				
Volts	230/208	230/208	230/208	230/208
Rated Load Amps 230/208	6.8/7.5	9.1/10.3	12.3/12.9	13.4/14.7
Branch Circuit Selection Current	8.6	10.3	13.7	14.7
Lock Rotor Amps 230/208	49/49	56/56	75/75	82/82
Crankcase Heat	NONE			
Fan Motor and Condenser				
Fan Motor -- HP/RPM	1/6 - 825			
Fan Motor -- Amps	1.1			
Fan -- Diameter/CFM	20" - 2000			
Sweat Fitting Size and Charge				
Suction Line Size ID	5/8"	3/4"	3/4"	3/4"
Liquid Line Size ID	1/4"	3/8"	3/8"	3/8"
Factory Charge R-22 Oz.	73 oz.	79 oz.	84 oz.	96 oz.
Shipping Weight Lb.	155	155	180	180

## I. APPLICATION AND LOCATION

### GENERAL

These instructions explain the recommended method to install the air cooled remote type condensing unit, the interconnecting refrigerant tubing, and the electrical wiring connections to the unit.

The condensing units are to be used in conjunction with the matching evaporator coils or evaporator blower units for comfort cooling applications as shown in the specification sheet.

These instructions and any instructions packaged with any separate equipment required to make up the entire air conditioning system should be carefully read before beginning the installation. Note particularly "Starting Procedure" and any tags and/or labels attached to the equipment.

While these instructions are intended as a general recommended guide, they do not supersede any national and/or local codes in any way. Authorities having jurisdiction should be consulted before the installation is made.

### SHIPPING DAMAGE

Upon receipt of equipment, the carton should be checked for external signs of shipping damage. If damage is found, the receiving party must contact the last carrier immediately, preferably in writing, requesting inspection by the carrier's agent.

### APPLICATION

Size of unit for a proposed installation should be based on heat loss calculation and air duct sizing made according to methods of Air Conditioning Contractors of America. The air duct should be installed in accordance with the Standards of the National Fire Protection Association for the Installation of Air Conditioning and Ventilating Systems of Other Than Residence Type, NEPA No. 90A, and Residence Type Warm Air Heating and Air Conditioning Systems, NEPA 90B. Where local regulations are at a variance with instructions, installer should adhere to local codes.

FIGURE 2

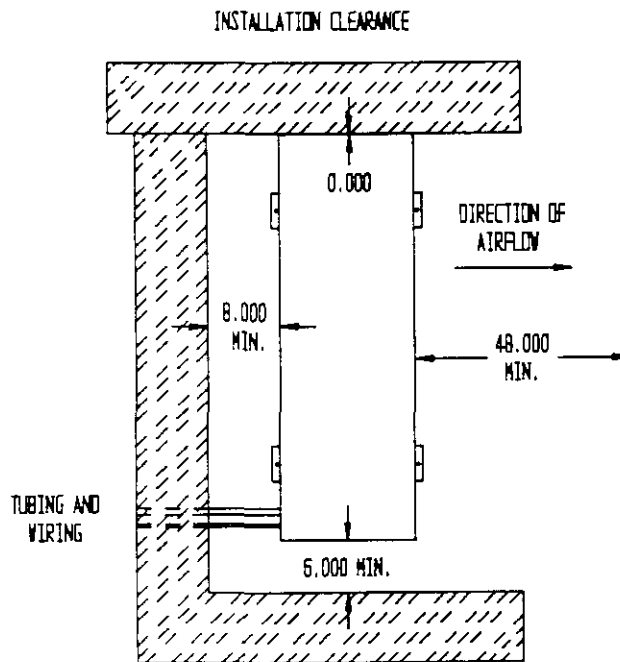

MIS-589

## LOCATION

The condensing unit is designed to be located outside with free and unobstructed condenser air inlet and discharge. It must also permit access for service and installation. Condenser air enters the coil and discharges. Refrigerant and electrical connections are made from the rear of the unit as shown in Figure 2 with electrical service access.

## MOUNTING UNIT OUTSIDE ON SLAB

A solid level base or platform, capable to support the unit's weight, must be set at the outdoor unit predetermined location. The base should be at least two inches larger than the base dimensions of the unit and at least two inches higher than surrounding grade level. The required unit minimum installed clearances must be maintained as called out in Figure 2 when locating and setting the base.

Remove the unit from its shipping carton and position the unit on the prepared base or platform.

Do not attach the unit or its base to the building structure to avoid the transmission of noise into the *occupied area*.

**NOTE:** These units employ internally sprung compressors; therefore, it is not necessary to remove or loosen the base mounting bolts on the compressor prior to operation.

Consideration should be given to the electrical and tubing connections when placing the unit to avoid unnecessary bends or length of material.

## IMPORTANT INSTALLER NOTE:

For improved start-up performance, wash the indoor coil with a dishwasher detergent.

## INSTALLING REFRIGERANT TUBING

The information that follows on installing refrigerant tubing and for changing the system orifice (if required) covers applications listed in the front of this installation instruction only. Although other indoor units may be of similar construction, the installation instructions for these units should be consulted for proper installation of those units prior to installation.

This information is provided for the field service personnel to install refrigerant tubing in compliance with Section 608 of Title VI National Recycling and Emission Reduction Program for the U.S. Clean Air Act effective July 1, 1992.

Consult manual 2100-002 on procedure for leak test--evacuation--charging before installation refrigerant tubing that requires any refrigerant recovery or system evacuation. Manual 2100-002 is included with the unit installation instruction package when shipped from the factory.

FIGURE 3

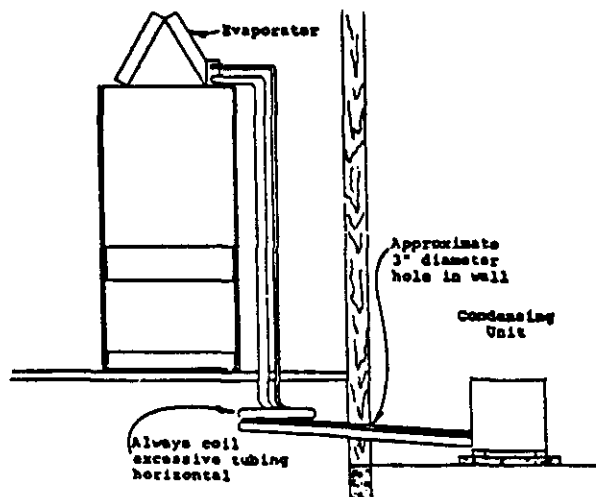

## SWEAT STYLE TUBING CONNECTIONS: SWEAT INDOOR UNIT AND SWEAT OUTDOOR UNIT

Use only refrigeration grade (dehydrated and sealed) copper tubing. Care must be taken to insure that the tubing is kept clean and dry before and during installation. Do not remove the plugs from the tubing ends, coil connections or base valves until the connection is ready to be brazed.

The suction line must be insulated with a minimum of 3/8" Armaflex or equivalent before cutting and making connections.

STEP 1--Being careful not to kink, route both the suction line and liquid line between the indoor unit and outdoor unit. Use a tubing bender to make any necessary bends in tubing. When necessary to bend the insulated tube suction line, cut the insulation around its circumference at a distance far enough beyond the point of the bend so as to clear the tubing bender. Slip the insulation back together and vapor seal the joint with tape. Coil any excess tubing in a horizontal place with the slope of the tubing toward the condensing unit.

CAUTION: 1. Be careful not to tear the insulation when pushing it through hole in masonry or frame walls. 2. When sealing the tube opening in house wall, use a soft material to prevent tube damage and vibration transmission. 3. Avoid excessive bending in any one place to avoid kinking.

STEP 2--The tubing ends should be cut square. Make sure it is round and free of burrs at the connecting ends. Clean the tubing to prevent contaminants from entering the system.

**NOTE:** DO NOT BRAZE LINE TO UNITS! If orifice needs to be changed, change out orifice first.

If the orifice does not have to be changed, skip the instructions outlined further in Step 3 and proceed to Step 8.

STEP 3--Disassemble Flow Control Assembly by turning body hex.

STEP 4--If existing orifice has not dropped out of the body when disassembled, remove by using a pin or paper clip. Discard this original orifice.

STEP 5--Insert proper sized orifice fully into the flow control body with rounded "bullet" nose towards the unit as shown. Insure the orifice stays inserted in body before connecting mating half. See chart in the outdoor unit installation instructions for proper size.

CAUTION: Be sure there is no dirt introduced into the flow control--orifice assembly. Be sure and install the orifice with the bullet nose pointing in the proper direction as shown in Figure 4. Failure to do so will result in improper operation.

FIGURE 4  
FLOW CONTROL ASSEMBLY  
FIELD ORIFICE REPLACEMENT INSTRUCTIONS

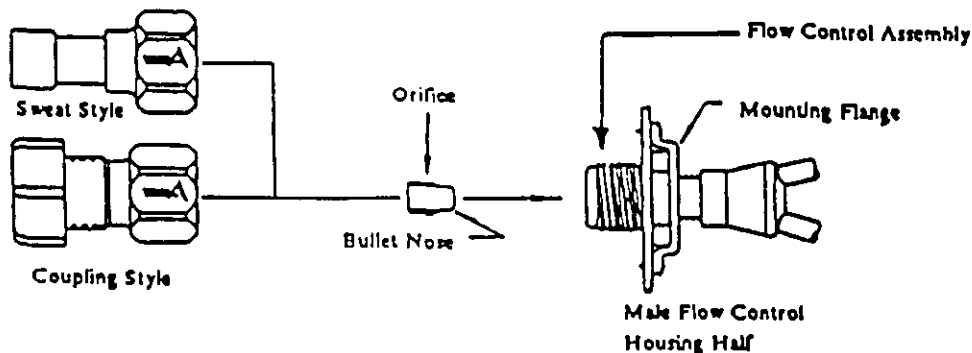



STEP 6--Thread assembly halves together by hand to insure proper mating of threads and tighten until bodies "bottom" or a definite resistance is felt.

STEP 7--Using a marker pen or ink pen, mark a line lengthwise from the union nut to the bulkhead. Then tighten an additional 1/6 turn (or 1 hex flat). The misalignment of the line will show the amount the assembly has been tightened. This final 1/6 turn is necessary to insure the formation of the leakproof joint.

STEP 8--Wrap a wet rag around the copper stub before brazing.

STEP 9--Flux the copper tube and insert into the stub. Braze the joint using an alloy of silver or copper and phosphorus with a melting temperature above 1100°F for copper to copper joints. The phosphorus will act as a flux, therefore, no flux will be required.

A copper-silver alloy with a high silver content should be used when iron or steel material is involved in the joint. These alloys require the use of silver solder flux. Alloys containing phosphorus should not be used with iron or steel. Phosphorus reacts with the iron, forming iron phosphate which is extremely brittle.

CAUTION: 1. Brazing alloys with a melting temperature below 700°F should not be used. 2. Lead-tin or tin-antimony solders should not be used due to their low melting point and necessity for corrosive fluxes.

To further prevent the formation of copper oxide inside the tubing, dry nitrogen may be purged through the refrigerant system during brazing.

\*\*\*\*\*

WARNING: Never purge or pressurize a system with oxygen. An explosion and fire will result.

\*\*\*\*\*

STEP 10--After brazing, quench with wet rag to cool the joint and remove any flux residue.

STEP 11--Leak test all connections using an electronic leak detector or a halide torch.

STEP 12--Evacuate suction line, liquid line, and indoor unit through outdoor unit base valves.

STEP 13--Open both the suction and liquid base valves to the fully open position. Refer to section later in installation instructions for details on setting proper system charge.

TABLE 3A

TUBING CHART						
Basic Condensing Unit Model	Refrigerant Line Length (Ft.)					
	0 - 20		21 - 60		61 - 100	
	Liquid	Suction	Liquid	Suction	Liquid	Suction
HAC181	1/4"	5/8"	1/4"	5/8"	3/8"	3/4"
HAC241	3/8"	5/8"	3/8"	3/4"	3/8"	3/4"
HAC301	3/8"	5/8"	3/8"	3/4"	3/8"	3/4"
HAC361	3/8"	5/8"	3/8"	3/4"	1/2"	7/8"

## FIELD FABRICATED TUBING CONNECTIONS: QUICK CONNECT INDOOR UNIT AND SWEAT OUTDOOR UNIT USING CTO KIT

Use only refrigeration grade (dehydrated and sealed) copper tubing. Care must be taken to insure that the tubing is kept clean and dry before and during installation. Do not remove the plugs from the tubing ends, coil connections or base valves until the connection is ready to be brazed.

The suction line must be insulated with a minimum of 3/8" Armaflex or equivalent before cutting and making connections.

STEP 1--Being careful not to kink, route both the suction line and liquid line between the indoor unit and outdoor unit. Use a tubing bender to make any necessary bends in tubing. When necessary to bend the insulated tube suction line, cut the insulation around its circumference at a distance far enough beyond the point of the bend so as to clear the tubing bender. Slip the insulation back together and vapor seal the joint with tape. Coil any excess tubing in a horizontal plane with the slope of the tubing toward the condensing unit.

CAUTION: 1. Be careful not to tear the insulation when pushing it through hole in masonry or frame walls. 2. When sealing the tube opening in house wall, use a soft material to prevent tube damage and vibration transmission. 3. Avoid excessive bending in any one place to avoid kinking.

STEP 2--The tubing ends should be cut square. Make sure it is round and free of burrs at the connecting ends. Clean the tubing to prevent contaminants from entering the system.

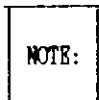

DO NOT make any tubing connection at indoor unit at this time. Make all brazing of joints and evacuate both suction and liquid line first.

STEP 3--Wrap a wet rag around the copper stub before brazing.

STEP 4--Flux the copper tube and insert into the stub. Braze the joint using an alloy of silver or copper and phosphorus with a melting temperature above 1100°F for copper to copper joints. The phosphorus will act as a flux, therefore, no flux will be required.

A copper-silver alloy with a high silver content should be used when iron or steel material is involved in the joint. These alloys require the use of silver solder flux. Alloys containing phosphorus should not be used with iron or steel. Phosphorus reacts with iron, forming iron phosphate which is extremely brittle.

CAUTION: 1. Brazing alloys with a melting temperature below 700°F should not be used. 2. Lead-tin or tin-antimony solders should not be used due to their low melting point and necessity for corrosive fluxes.

To further prevent the formation of copper oxide inside the tubing, dry nitrogen may be purged through the refrigerant system during brazing.

\*\*\*\*\*

WARNING: Never purge or pressurize a system with oxygen. An explosion and fire will result.

\*\*\*\*\*

STEP 5--After brazing, quench with wet rag to cool the joint and remove any flux residue.

STEP 6--Leak test all connections using an electronic leak detector or a halide torch.

STEP 7--Evacuate suction line and liquid line through outdoor unit base valves.

If orifice does not have to be changed, skip the instructions outlined further in Step 8 and proceed to Step 15.

STEP 8--Recover charge from the indoor unit.

- A. Connect the suction line only to the indoor unit as outlined in Steps 15, 16 and 17.
- B. Recover indoor unit and suction line unit charge through service port located on outdoor unit base valve.

STEP 9--Disassemble Flow Control Assembly by turning body hex.

STEP 10--If existing orifice has not dropped out of the body when disassembled, remove by using a pin or paper clip. Discard this original orifice.

STEP 11--Insert proper sized orifice fully into the flow control body with rounded "bullet" nose towards the unit as shown. Insure the orifice stays inserted in body before connecting mating half. See chart in the outdoor unit installation instructions for proper size.

**CAUTION:** Be sure there is no dirt introduced into the flow control--orifice assembly. Be sure and install the orifice with the bullet nose pointing in the proper direction as shown in Figure 4. Failure to do so will result in improper operation.

STEP 12--Thread assembly halves together by hand to insure proper mating of threads and tighten until bodies "bottom" or a definite resistance is felt.

STEP 13--Using a marker pen or ink pen, mark a line lengthwise from the union nut to the bulkhead. Then tighten an additional 1/6 turn (or 1 hex flat). The misalignment of the line will show the amount the assembly has been tightened. This final 1/6 turn is necessary to insure the formation of the leakproof joint.

STEP 14--Evacuate the suction line and indoor unit through the outdoor unit base valve before connecting all other tubing. Refer to section later in installation instructions for details on setting the proper refrigerant charge.

STEP 15--Remove (remaining) protector caps and plugs (if orifice was changed). Inspect fittings and if necessary carefully wipe coupling seats and threaded surfaces with a clean cloth to prevent the inclusion of dirt or any foreign material in the system.

STEP 16--Lubricate male half diaphragm and synthetic rubber seal with refrigerant oil. Thread coupling halves together by hand to insure proper mating of threads. Be sure to hold the coupling firmly to prevent movement of the coupling and tubing. Failure to do so could tear out the diaphragm causing a blockage of the system. Use proper size wrenches (on coupling body hex and on union nut) and tighten until coupling bodies "bottom" or a definite resistance is felt.

**CAUTION:** After starting to tighten up the fitting, never try to back it off or take it apart.

STEP 17--Using a marker or ink pen, mark a line lengthwise from the coupling union nut to the bulkhead. Then tighten an additional 1/4 turn. The misalignment of the line will show the amount the coupling has been tightened. This final 1/4 turn is necessary to insure the formation of leak proof joint. If a torque wrench is used, the following torque values are recommended.

TABLE 4

Coupling Size	Ft. Lbs.
-6	10 - 12
-10	35 - 45
-11	35 - 45
-12	50 - 65

STEP 18--Leak test all connections using an electronic leak detector or a halide torch.

STEP 19--When tubing is installed in attics or drop ceilings, insulate the couplings on the larger tube thoroughly with 3/8" wall thickness, closed cell sponge tube insulation or equivalent. Failure to insulate will result in water damage to ceiling since the fitting will "sweat" and drop water on the ceiling.

STEP 20--Open both the suction and liquid base valves to the fully open position. Refer to section later in installation instructions for details on setting proper system charge.

## II. WIRING INSTRUCTIONS

### GENERAL

All wiring must be installed in accordance with the National Electrical Code and local codes. In Canada, all wiring must be installed in accordance with the Canadian Electrical Code and in accordance with the regulations of the authorities having jurisdiction. Power supply voltage must conform to the voltage shown on the unit serial plate. A wiring diagram of the unit is attached to the inside of the electrical cover. The power supply shall be sized and fused according to the specifications supplied. A ground lug is supplied in the control compartment for equipment ground.

The unit rating plate lists a "Maximum Time Delay Fuse" or "RACR Type" circuit breaker that is to be used with the equipment. The correct size must be used for proper circuit protection and also to assure that there will be no nuisance tripping due to the momentary high starting current of the compressor motor.

### CONTROL CIRCUIT WIRING

For split systems, the minimum control circuit wiring gauge needed to insure proper operation of all controls in both indoor and outdoor units will depend on two factors.

1. The rated VA of the control circuit transformer.
2. The maximum total distance of the control circuit wiring. (This is the distance between the wall thermostat to the indoor unit plus the distance between the indoor unit to the outdoor unit.)

The following table should be used to determine proper gauge of control circuit wiring required.

TABLE 5

Rated VA of Control Circuit Transformer	Transformer Secondary FLA @ 24V	Maximum Total Distance of Control Circuit Wiring In Feet
40	1.6	20 gauge - 65 18 gauge - 90 16 gauge - 145 14 gauge - 230
50	2.1	20 gauge - 45 18 gauge - 60 16 gauge - 100 14 gauge - 160 12 gauge - 250
65	2.7	20 gauge - 40 18 gauge - 55 16 gauge - 85 14 gauge - 135 12 gauge - 210

Example: 1. Control circuit transformer rated at 40VA.

2. Maximum total distance of control circuit wiring 85 feet.

From Table 5, minimum of 18 gauge wire should be used in the control circuit wiring.

For control circuit transformers rated other than those listed, use the next lower rated transformer listed.

Example: 1. Control circuit transformer rated at 55VA.

From table use 50VA transformer.

There are two (2) separate control diagrams for fossil fuel furnaces with air conditioners.

Control diagrams for the various circuits which could be encountered with blower coils can be found in the installation instructions of the blower coil.

TABLE 6

System	Gas Furnace Control Diagram	Oil Furnace Control Diagram
All Models	4091-100	4091-101

4 IF95-80



1 T87F3111/0539A1220

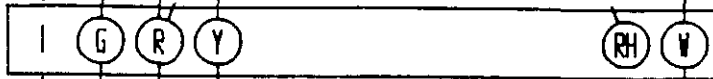

T87F3111/0539A1006

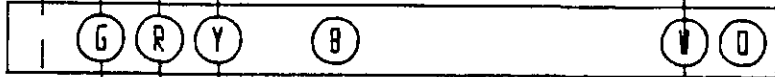

IF56-318



3 FURNACE 24V TERMINAL,  
FAN CENTER 5900-01E005A07  
R8325A1057, 175-200101-10  
OR ELECTRONIC BLOWER CONTROL  
45200, 24V TERMINAL.



OUTDOOR UNIT  
24V CONNECTIONS



1 SET ADJUST HEAT ANTICIPATOR (SEE FURNACE INSTALLATION INSTRUCTIONS)

2 INSTALL JUMPER R-RH

3 IF THE FURNACE IS NOT INTERNALLY WIRED FOR ADD ON AIR CONDITIONING, A FAN CENTER WILL NEED TO BE ADDED.

4 OPTION SWITCH SETTING

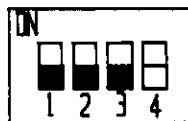

SWITCH #1 "OFF"

SWITCH #2 "OFF"

SWITCH #3 "OFF"

SWITCH #4 SEE THERMOSTAT  
INSTALLATION INSTRUCTIONS

	FACTORY WIRING	FIELD WIRING
LOW VOLTAGE	_____	-----
HIGH VOLTAGE	_____	-----

AIR CONDITIONER W/GAS FURNACE

⚠ T87F3111/8539A1220

⚠ FURNACE 24V TERMINAL  
 FAN CENTER 5900-01E005A07  
 R8325A1057, 175-200101-10  
 OR ELECTRONIC BLOWER CONTROL  
 45200, 24V TERMINAL.

OUTDOOR UNIT  
 24V CONNECTIONS

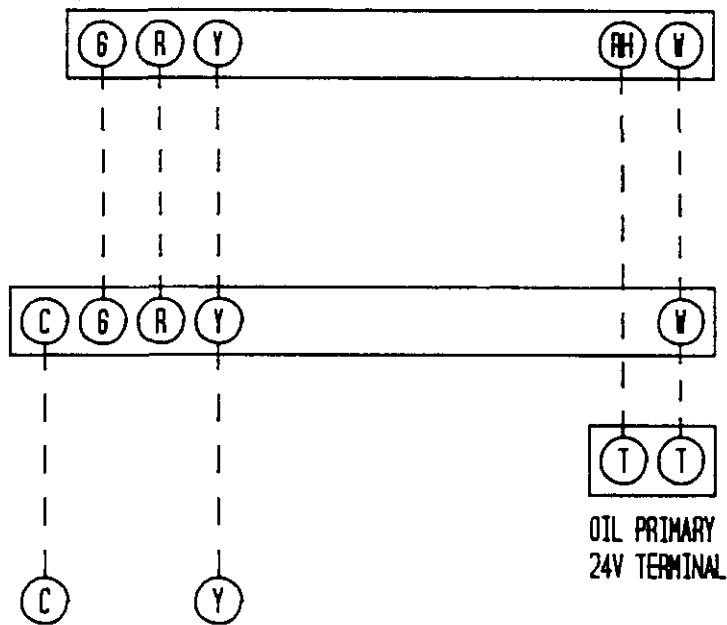

⚠ SET ADJUST HEAT ANTICIPATOR (SEE FURNACE INSTALLATION INSTRUCTIONS)

⚠ IF THE FURNACE IS NOT INTERNALLY WIRED FOR ADD ON AIR CONDITIONING, A FAN CENTER WILL NEED TO BE ADDED.

	FACTORY WIRING	FIELD WIRING
LOW VOLTAGE	_____	-----
HIGH VOLTAGE	—————	-----

AIR CONDITIONER W/OIL FURNACE

## WALL THERMOSTATS

The following wall thermostats and subbases should be used as indicated, depending on the application.

TABLE 7

AIR CONDITIONING THERMOSTATS		
Part No.	Model No.	Description
8403-002	T87F3111	THERMOSTAT--1 stg. heat, adj. heater, Mercury
8404-003	Q539A1220	SUBBASE --System Heat-Off-Cool Fan: On-Auto
8403-008	ID51-605	THERMOSTAT--1 stg. cool, System w/Off Sw. Snap Action Fan: Auto-On
8403-009	IF56-318	THERMOSTAT--1 st. cool, 1 stg. heat, Adj. heater Mercury System: Heat-Off-Cool Fan: Auto-On
8403-019	T874C1000	THERMOSTAT--1 stg. cool, 2 stg. heat, Adj. heater. Mercury
8404-012	Q674A1001	SUBBASE --System: Heat-Auto-Cool Fan: Auto-On



OPTIONAL CONTROLS

FIGURE 5

Component Mounting Location  
MIS-592

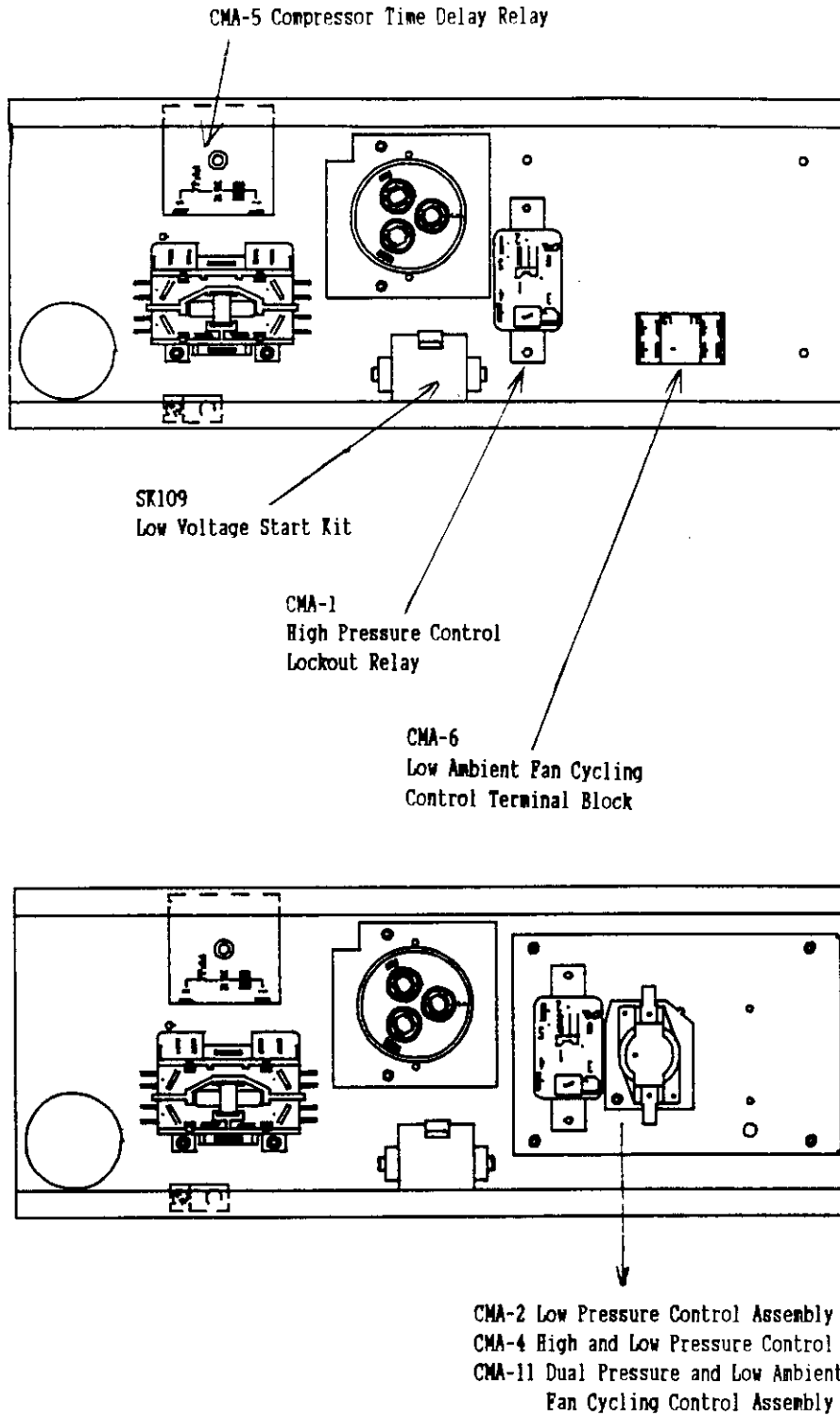

**INSTALLATION INSTRUCTIONS  
CMA-1  
HIGH PRESSURE CONTROL**

FIGURE 6  
MIS-597

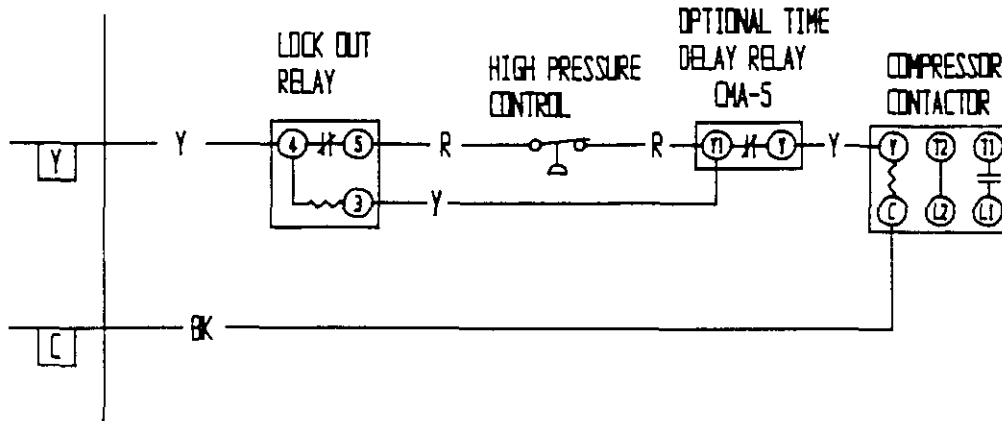

**INSTALLATION INSTRUCTIONS**

Disconnect all power to unit. Remove control panel cover.

- Step 1. Mount lockout relay in position shown in Figure 5.
- Step 2. Disconnect yellow low voltage (Y) wire at compressor contactor coil or (Y1) at optional CMA-5 and reconnect to terminal #4 of the lockout relay.
- Step 3. Connect yellow wire from terminal #3 of the lockout relay to the (Y) terminal of the compressor contactor coil or (Y1) at optional CMA-5. This is the terminal that the wire was removed from in Step 2.
- Step 4. Route High (red) pressure switch wires up through the bushing in the bottom of the control panel. Connect the High pressure switch wires between terminal #5 of the Lockout relay and the (Y) terminal of the compressor contactor coil or (Y1) at optional CMA-5.
- Step 5. Remove service port cap on the discharge line. Install the high pressure switch on the discharge line with the flare tee adapter that is brazed to the high pressure switch. Check for pressure at the flare tee dill valves after installation to insure that the dill valve in the unit service port was depressed by the flare tee connector. Check for leaks at the flare tee connectors. Replace service port cap on the flare tee service port and tighten.
- Step 6. Recheck wiring (see Figure 6). Check for proper operation of the unit by energizing in cooling mode for at least 5 minutes. The unit should not go into lockout.
- Step 7. Replace all panels and covers. This completes installation.

**INSTALLATION INSTRUCTIONS  
CMA-2  
LOW PRESSURE CONTROL**

FIGURE 7  
MIS-596

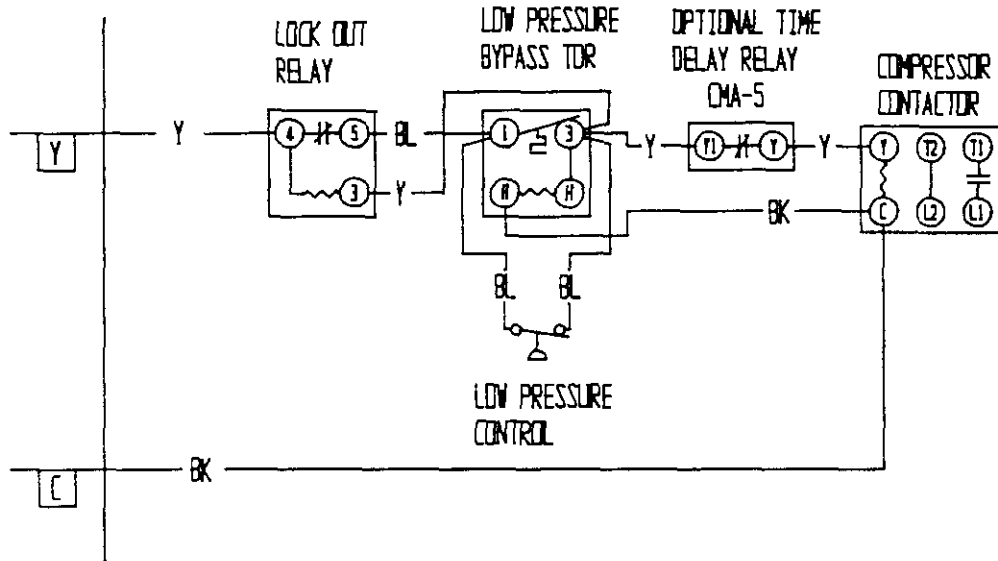

**INSTALLATION INSTRUCTIONS**

Disconnect all power to unit. Remove control panel cover.

- Step 1. Snap control assembly into control panel as shown in Figure 5.
- Step 2. Disconnect yellow low voltage (Y) wire at compressor contactor coil or (Y1) at optional CMA-5 and reconnect to terminal #4 of the lockout relay.
- Step 3. Connect yellow wire from terminal #3 of the low pressure bypass TDR to the (Y) terminal of the compressor contactor coil or (Y1) at optional CMA-5. This is the terminal that the wire was removed from in Step 2.
- Step 4. Connect the black wire from terminal H of the low pressure bypass TDR to the common (C) side of the compressor contactor coil.
- Step 5. Route low (blue) pressure switch wires up through the bushing in the bottom of the control panel. Connect low pressure switch wires between terminals #1 and #3 of the low pressure bypass TDR.
- Step 6. Remove service port caps on the suction line. Install the low pressure switch on the suction line with the flare tee adapter that is brazed to the low pressure switch. Check for pressure at the flare tee dill valves after installation to insure that the dill valve in the unit service port was depressed by the flare tee connector. Check for leaks at the flare tee connectors. Replace service port caps on the flare tee service ports and tighten.
- Step 7. Recheck wiring. See figure 7. Check for proper operation of the unit by energizing in heating or cooling mode for at least 5 minutes. The unit should not go into lockout.
- Step 8. Replace all panels and covers. This completes installation.

## INSTALLATION INSTRUCTIONS FOR CMA-4 HIGH AND LOW PRESSURE CONTROL

FIGURE 8  
MIS-595

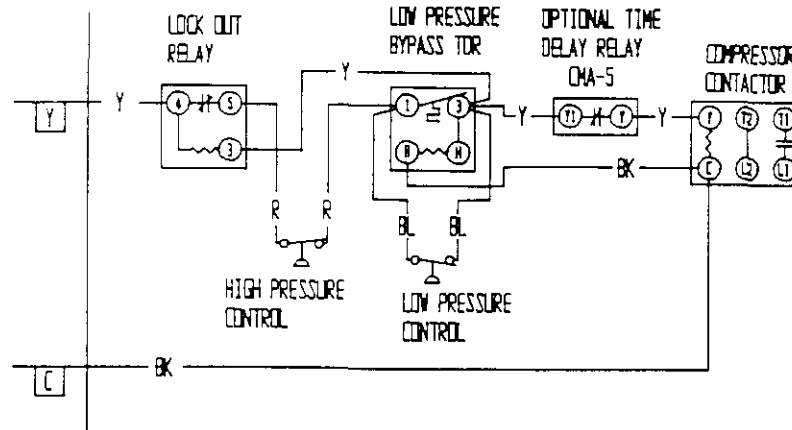

### INSTALLATION INSTRUCTIONS

Disconnect all power to unit. Remove control panel cover.

- Step 1. Snap control assembly into control panel as shown in Figure 5.
- Step 2. Disconnect yellow low voltage (Y) wire at compressor contactor coil or (Y1) at optional CMA-5 and reconnect to terminal #4 of the lockout relay.
- Step 3. Connect yellow wire from terminal #3 of the low pressure bypass TDR to the (Y) terminal of the compressor contactor coil or (Y1) at optional CMA-5. This is the terminal that the wire was removed from in Step 2.
- Step 4. Connect the black wire from terminal H of the low pressure bypass TDR to the common (C) side of the compressor contactor coil.
- Step 5. Route High (red) and Low (blue) pressure control wires up through the bushing in the bottom of the control panel. Connect Low pressure control wires between terminals #1 and #3 of the low pressure bypass TDR.
- Step 6. Connect the High pressure control wires between terminal #5 of the Lockout relay and terminal #1 of the low pressure bypass TDR.
- Step 7. Remove service port caps on both the suction and discharge lines. Install the high pressure control on the discharge line with the flare tee adapter that is brazed to the high pressure switch. Install the low pressure control on the suction line. Check for pressure at the flare tee dill valves after installation to insure that the dill valve in the unit service port was depressed by the flare tee connector. Check for leaks at the flare tee connectors. Replace service port caps on the flare tee service ports and tighten.
- Step 8. Recheck wiring. Refer to Figure 8. Check for proper operation of the unit by energizing in heating or cooling mode for at least 5 minutes. The unit should not go into lockout.
- Step 9. Apply "This unit equipped with CMA-4 control module" label to inside of inner control panel cover above wiring diagram. Leave these instructions in the unit.
- Step 10. Replace all panels and covers. This completes installation.

INSTALLATION INSTRUCTIONS  
FOR CMA-5  
COMPRESSOR TIME DELAY RELAY

FIGURE 9  
HIS-598

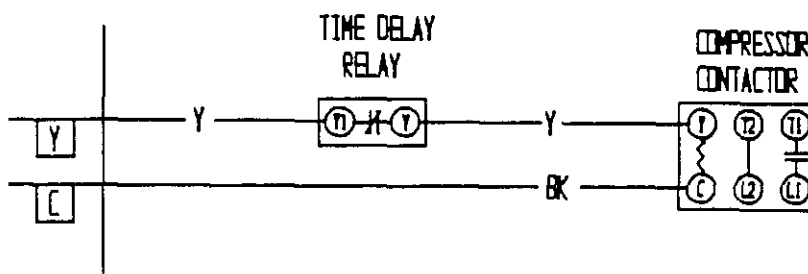

**INSTALLATION INSTRUCTIONS**

Disconnect all power to the unit. Remove control panel cover.

- Step 1. Mount compressor TDR in position shown in Figure 5 with screw provided.
- Step 2. Disconnect yellow low voltage (Y) wire at the compressor contactor coil and reconnect to the Y1 or #3 terminal of the TDR.
- Step 3. Connect yellow wire from terminal (Y) of the TDR to the (Y) terminal of the compressor contactor coil. This is the terminal that the wire was removed from in Step 2.
- Step 4. Recheck wiring. Refer to Figure 9. Energize unit. Compressor should start. Remove power and reapply. Compressor should not start until the 5 minute time delay has expired.
- Step 5. Apply "This unit equipped with CMA-5 control module" label to inside of the inner control panel cover above wiring diagram.
- Step 6. Replace all panels and covers. This completes installation.

**INSTALLATION INSTRUCTIONS**  
**CMA-6**  
**LOW AMBIENT FAN CYCLING CONTROL**

FIGURE 10  
MIS-594

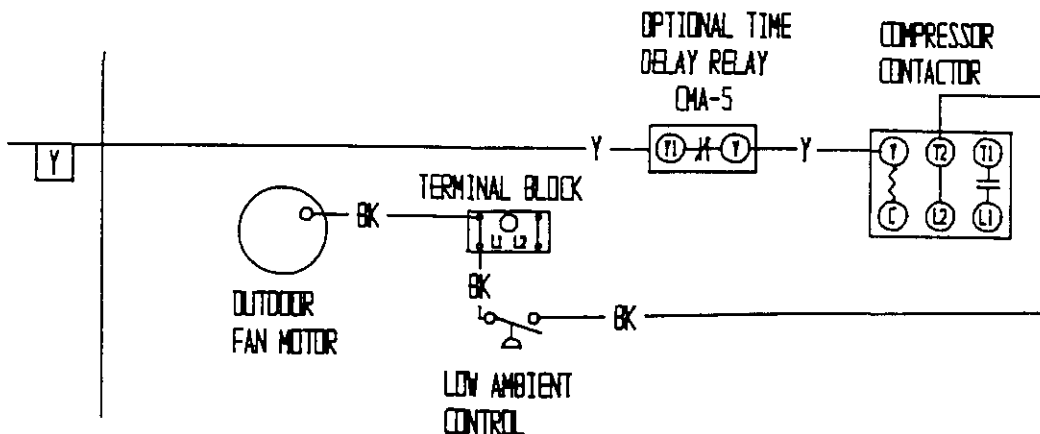

**INSTALLATION INSTRUCTIONS**

Disconnect all power to unit. Remove control panel inner and outer cover.

- Step 1. Mount terminal block in position shown in Figure 5.
- Step 2. Disconnect black high voltage outdoor motor lead from compressor contactor and reconnect to terminal block.
- Step 3. Route Low ambient control wires up through the bushing in the bottom of the control panel. Connect the low ambient control wires between the terminal block and T2 of the compressor contactor.
- Step 4. Remove service port cap on discharge line. Install the low ambient control on the discharge line with the flare tee adapter that is brazed to the low ambient control. Check for pressure at the flare tee dill valve after installation to insure that the dill valve in the unit service port was depressed by the flare tee connector. Check for leaks at the flare tee connectors. Replace service port cap on the flare tee service port and tighten.
- Step 5. Recheck wiring. See Figure 10. Check for proper operation of the unit by energizing in cooling mode. The condenser fan motor should not run until the discharge pressure has exceeded 300 PSI. Should the discharge pressure fall below 200 PSI while running, the condenser fan motor will de-energize until the head pressure builds to 300 PSI.
- Step 6. Apply "This unit equipped with CMA-6 control module" label to the inside of the control panel cover above the wiring diagrams.
- Step 7. Replace all panels and covers. This completes installation.

**INSTALLATION INSTRUCTIONS**  
**CMA-11**  
**DUAL PRESSURE AND LOW AMBIENT**  
**FAN CYCLING CONTROL**

FIGURE 11  
MIS-593

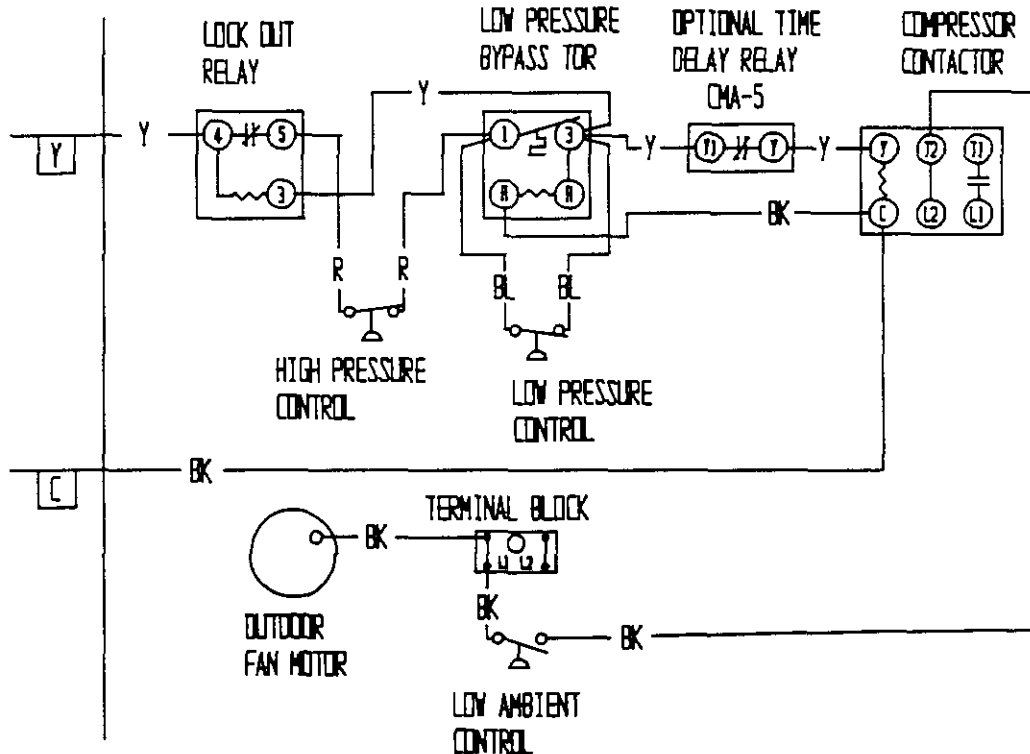

**INSTALLATION INSTRUCTIONS**

Disconnect all power to unit. Remove control panel inner cover.

- Step 1. Snap control assembly into control panel as shown in Figure 5.
- Step 2. Disconnect yellow low voltage (Y) wire at compressor contactor coil or (Y1) at optional CMA-5 and reconnect to terminal #4 of the lockout relay.
- Step 3. Connect the black wire from terminal H of the low pressure bypass TDR to the common (C) side of the compressor contactor coil.
- Step 4. Connect yellow wire from terminal #1 or (Y) of the low pressure bypass relay to the (Y) terminal of the compressor contactor coil or (Y1) at optional CMA-5. This is the terminal that the wire was removed from in Step 2.
- Step 5. Route high (red) and low (blue) pressure switch wires up through the bushing in the bottom of the control panel. Connect the high pressure switch wires between terminal #5 of the lockout relay and terminal #1 of the low pressure bypass TDR.
- Step 6. Connect low pressure switch wires between terminals #1 and #3 of the low pressure bypass TDR.
- Step 7. Disconnect black high voltage outdoor motor lead from compressor contactor and reconnect to terminal block.

- Step 8. Route low ambient control wires up through the bushing in the bottom of the control panel. Connect the low ambient control wires between the terminal block and T2 of the compressor contactor.
- Step 9. Remove service port caps on both the suction and discharge lines. Install the high pressure switch and low ambient control on the discharge line with the flare tee adapter that is brazed to the controls. Install the low pressure switch on the suction line. Check for pressure at the flare tee dill valves after installation to insure that the dill valve in the unit service port was depressed by the flare tee connector. Check for leaks at the flare tee connectors. Replace service port caps on the flare tee service ports and tighten.
- Step 10. Recheck wiring. Refer to Figure 11. Energize unit in first stage cooling. Compressor should start. Run the unit for at least 5 minutes. The unit should not go into lockout. The condenser fan motor should not run until the discharge pressure has exceeded 300 PSI. Should the discharge pressure fall below 200 PSI while running, the condenser fan motor will de-energize until the head pressure builds to 300 PSI.
- Step 11. Apply "This unit equipped with CMA-11 control module" label to the inside of the inner control panel cover above the wiring diagram.
- Step 12. Replace all panels and covers. This completes installation.

### III. CHARGING INSTRUCTIONS

#### PRESSURE SERVICE PORTS

High and low pressure service ports are installed on all units so that the system operating pressures can be observed. Pressure tables can be found later in the manual covering all models. It is imperative to match the correct pressure table to the unit by model number.



## SYSTEM START-UP (INDOOR UNITS WITHOUT EXPANSION VALVES)

STEP 1--Close disconnect switch(es) and set the thermostat to cool and the temperature to the highest setting.

STEP 2--Check for proper airflow across the indoor coil by referring to indoor unit installation instructions.

STEP 3--Connect the service gauges and allow the unit to run for at least 10 minutes or until pressures are stable. Check pressures to the system pressure table attached to the outdoor unit service panel. For optimum system performance, go to Step 4.

STEP 4--Install a thermometer on the suction line approximately 6" to 10" from the compressor. Optimum system performance will occur with a refrigerant charge resulting in a suction line superheat as determined from the following calculations.

- A. Measure outdoor air dry bulb temperature \_\_\_\_\_ °F
- B. Measure indoor air wet bulb temperature \_\_\_\_\_ °F
- C. Measure suction pressure \_\_\_\_\_ PSIG
- D. Measure suction line temperature \_\_\_\_\_ °F
- E. Determine optimum system superheat from Table 9 using outdoor air dry bulb (Step B) and indoor air wet bulb (Step A). \_\_\_\_\_ °F
- F. Determine saturated suction temperature from suction pressure using Table 8. \_\_\_\_\_ °F
- G. Determine system superheat:  
 Suction line temperature (Step D) \_\_\_\_\_ °F  
 - Saturated suction temperature (Step F) - \_\_\_\_\_ °F  
 = System superheat = \_\_\_\_\_ °F
- H. Adjust the system superheat (Step G) to the optimum system superheat (Step E) by adding charge to lower the superheat or removing charge to raise the superheat.
- I. Check final system operating pressures to the system pressure tables as was done in Step 3.

TABLE 8 SATURATED SUCTION TEMPERATURE (R-22)

Suction Pressure PSIG	Saturated Suction Temperature (Deg. F)
50	26
53	28
55	30
58	32
61	34
63	36
65	38
67	39
70	41
73	43
76	45
79	47
82	49
86	51

TABLE 9 SYSTEM SUPERHEAT

Outdoor Ambient Temperature (Deg. F Dry Bulb)	Return Air Temperature Deg. F--Wet Bulb			
	59	63	67	71
105	1	1	5	
95	1	3	(8)	20
90	1	7	14	26
85	3	9	19	33
80	8	14	25	39
75	10	20	30	42

TABLE 10

TOTAL SYSTEM OPERATING CHARGE (Includes charge for the basic outdoor unit, indoor coil and 25' or interconnecting tubing)										
Outdoor Section	Indoor Section	Total R-22 Charge (Oz.)								
HAC181-A	S24AS-A BC24B	73 (1) 78								
HAC241-A	S24AS-A BC24B	80 (2) 79								
HAC301-A	A36AS-A BC36B	84 (2) 95								
HAC361-A	A37AS-A BC36B	98 (2) 96								
<p>(1) Includes 25' of 1/4" diameter liquid line. For other than 25' and other tube sizes, adjust the total charge according to the following schedule.</p> <p>(2) Includes 25' of 3/8" diameter liquid line. For other than 25' and other tube sizes, adjust the total charge according to the following schedule.</p> <table border="0"> <thead> <tr> <th><u>Liquid Line Diameter</u></th> <th><u>Oz. R-22 Per Ft.</u></th> </tr> </thead> <tbody> <tr> <td>1/4"</td> <td>.25</td> </tr> <tr> <td>3/8"</td> <td>.6</td> </tr> <tr> <td>1/2"</td> <td>1.2</td> </tr> </tbody> </table> <p>INSTALLER NOTE: Stamp or mark the final system charge determined above on the outdoor unit serial plate.</p>			<u>Liquid Line Diameter</u>	<u>Oz. R-22 Per Ft.</u>	1/4"	.25	3/8"	.6	1/2"	1.2
<u>Liquid Line Diameter</u>	<u>Oz. R-22 Per Ft.</u>									
1/4"	.25									
3/8"	.6									
1/2"	1.2									

## IV. SERVICE

### SERVICE HINTS

1. Caution homeowner to maintain clean air filters at all times. Also, not to needlessly close off supply and return air registers. This reduces air flow through the system, which shortens equipment service life, as well as, increasing operating costs.
2. Check all power fuses or circuit breakers to be sure that they are the correct rating.
3. Periodic cleaning of the outdoor coil to permit full and unrestricted air flow circulation is essential.

### FAN BLADE SETTING DIMENSIONS

Shown in the drawing below are the correct fan blade setting dimensions for proper air delivery across the outdoor coil.

Any service work requiring removal or adjustment in the fan and/or motor area will require that the dimensions below be checked and blade adjusted in or out on the motor shaft accordingly.

FIGURE 12

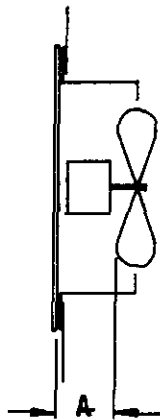

TABLE 11

Model	Dimension A
HAC181 HAC241 HAC301 HAC361	3"

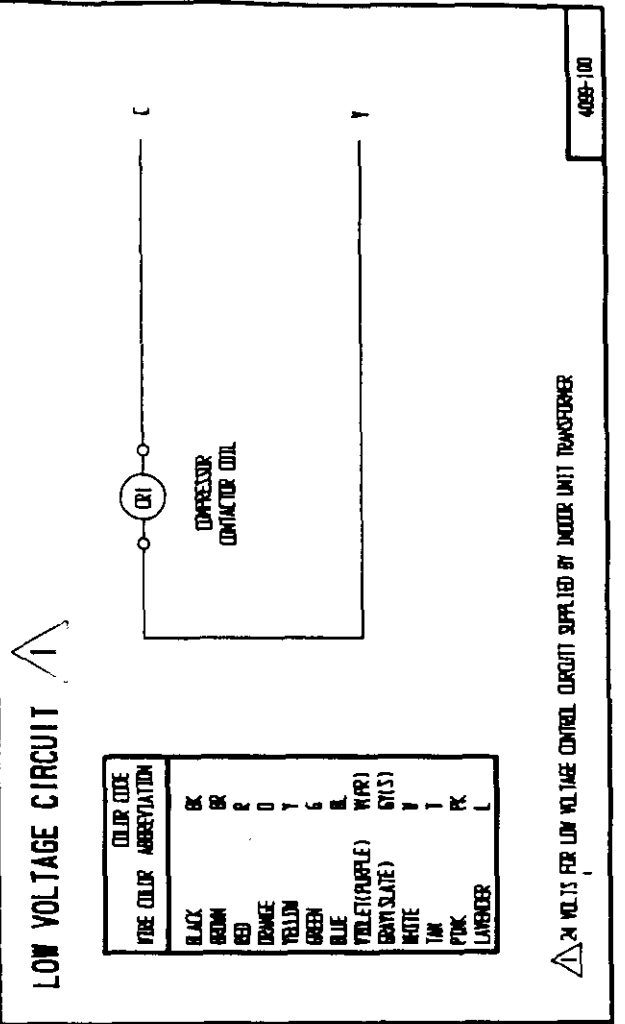
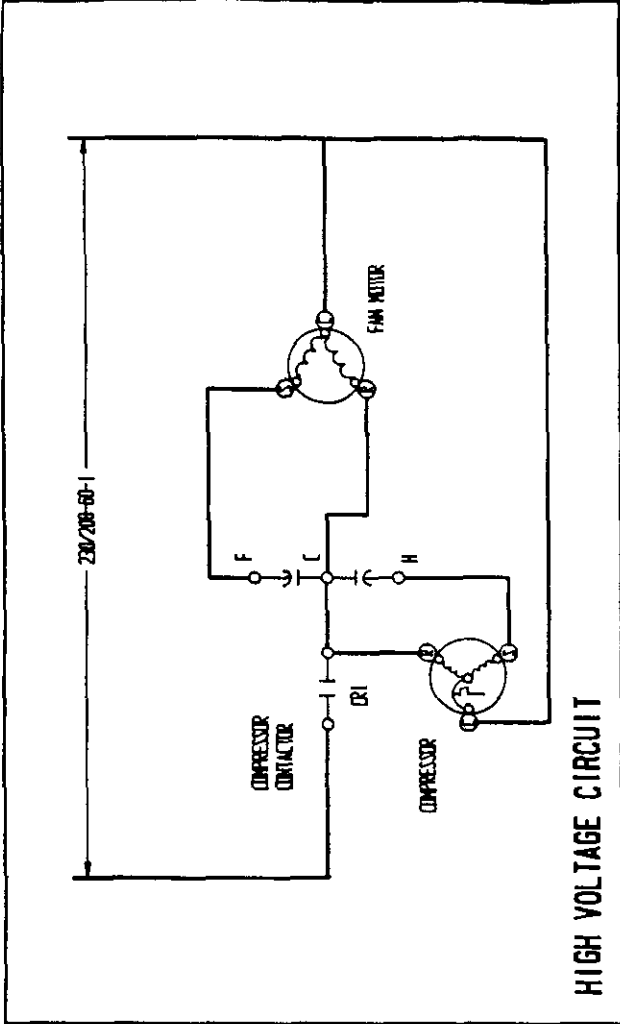
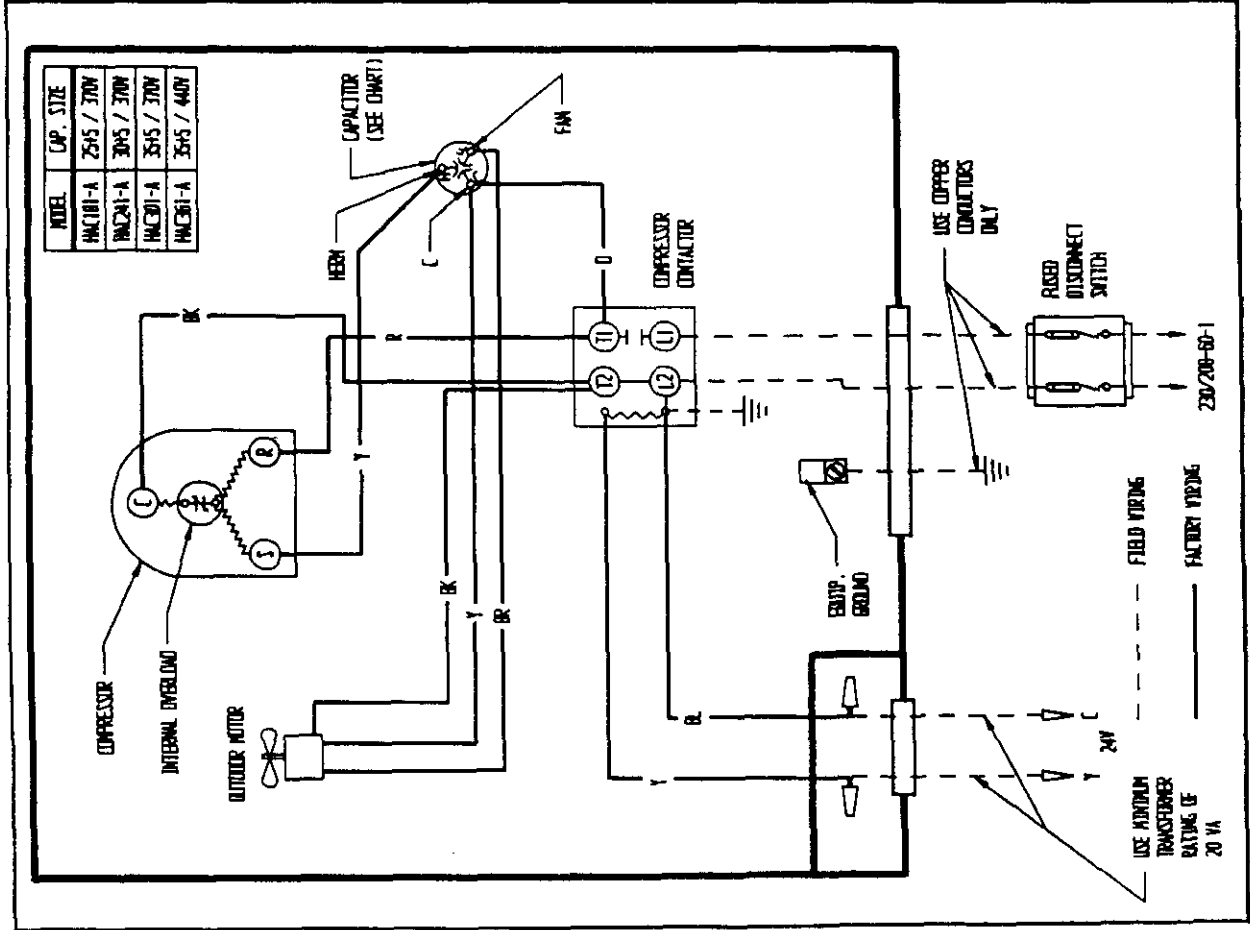

TABLE 12  
COOLING

HAC181-A

Indoor Section	Return Air Temperature	Pressure	65	70	75	80	85	90	95	100	105	110	115	
S24AS-A Rated CFM 650	75° DB / 62° WB	Low Side	68	70	72	74	76	78	80	82	84	85	87	
		High Side	150	170	187	203	226	244	254	258	255	246	320	
	80° DB / 67° WB	Low Side	70	73	76	79	81	84	86	88	90	92	93	
		High Side	169	183	198	213	228	244	260	276	293	310	328	
	85° DB / 72° WB	Low Side	76	79	82	85	87	90	92	94	96	98	99	
		High Side	177	191	206	221	236	252	269	286	304	322	340	
	BC24B Rated CFM 650	75° DB / 62° WB	Low Side	55	62	68	73	78	81	84	86	87	87	87
			High Side	162	178	193	209	224	240	256	272	288	304	320
80° DB / 67° WB		Low Side	77	78	78	80	81	82	84	86	88	90	93	
		High Side	164	180	197	213	230	246	263	280	296	313	329	
85° DB / 72° WB		Low Side	76	79	82	85	87	90	92	94	96	98	99	
		High Side	177	191	206	221	236	252	269	286	304	322	340	

Low side pressure + 2 PSIG (suction line 8 inches from compressor)

High side pressure + 5 PSIG (discharge line 8 inches from compressor, liquid at base valve approximately -5 PSIG from values listed)

Tables are based upon rated CFM (airflow) across the evaporator coil. If there is any doubt as to correct operating charge being in the system, the charge should be removed, system evacuated, and recharged to serial plate instructions.

TABLE 13  
COOLING

HAC241-A

Indoor Section	Return Air Temperature	Pressure	65	70	75	80	85	90	95	100	105	110	115	
S24AS-A Rated CFM 800	75° DB / 62° WB	Low Side	60	64	68	71	74	76	78	80	81	82	82	
		High Side	172	190	207	224	241	258	275	292	308	325	341	
	80° DB / 67° WB	Low Side	66	70	73	76	79	81	83	85	86	87	88	
		High Side	177	195	213	230	247	265	282	299	316	333	350	
	85° DB / 72° WB	Low Side	73	76	79	82	85	87	89	91	92	94	95	
		High Side	185	203	220	238	257	273	291	309	326	344	362	
	BC24B Rated CFM 800	75° DB / 62° WB	Low Side	65	69	73	77	80	82	83	84	85	86	87
			High Side	179	194	209	225	241	257	273	290	306	324	341
80° DB / 67° WB		Low Side	70	73	75	77	79	81	83	85	86	88	89	
		High Side	104	152	192	225	251	269	280	284	281	270	252	
85° DB / 72° WB		Low Side	73	76	79	82	85	87	89	91	92	94	95	
		High Side	185	203	220	238	256	273	291	309	326	344	362	

Low side pressure + 2 PSIG (suction line 8 inches from compressor)

High side pressure + 5 PSIG (discharge line 8 inches from compressor, liquid at base valve approximately -5 PSIG from values listed)

Tables are based upon rated CFM (airflow) across the evaporator coil. If there is any doubt as to correct operating charge being in the system, the charge should be removed, system evacuated, and recharged to serial plate instructions.

TABLE 14  
COOLING

HAC301-A

Indoor Section	Return Air Temperature	Pressure	65	70	75	80	85	90	95	100	105	110	115
A36AS-A Rated CFM 1000	75° DB / 62° WB	Low Side	62	65	67	69	71	73	75	77	78	80	81
		High Side	162	183	204	224	244	262	280	297	313	329	344
	80° DB / 67° WB	Low Side	68	70	72	74	76	78	80	82	84	85	87
		High Side	167	188	210	230	250	269	287	305	321	338	353
	85° DB / 72° WB	Low Side	75	77	78	80	82	84	86	88	90	92	94
		High Side	171	194	216	238	258	278	297	315	333	349	365
BC36B Rated CFM 1000	75° DB / 62° WB	Low Side	61	65	69	72	75	77	79	81	82	83	84
		High Side	185	201	217	234	250	266	282	298	314	331	347
	80° DB / 67° WB	Low Side	67	71	74	77	80	82	84	86	87	88	89
		High Side	190	207	223	239	256	272	289	306	322	339	356
	85° DB / 72° WB	Low Side	74	77	80	83	86	88	90	92	93	95	96
		High Side	198	215	232	248	265	282	299	316	333	351	368

Low side pressure + 2 PSIG (suction line 8 inches from compressor)

High side pressure + 5 PSIG (discharge line 8 inches from compressor, liquid at base valve approximately -10 PSIG from values listed)

Tables are based upon rated CFM (airflow) across the evaporator coil. If there is any doubt as to correct operating charge being in the system, the charge should be removed, system evacuated, and recharged to serial plate instructions.

TABLE 15  
COOLING

HAC361-A

Indoor Section	Return Air Temperature	Pressure	65	70	75	80	85	90	95	100	105	110	115
A37AS-A Rated CFM 1100	75° DB / 62° WB	Low Side	66	68	70	72	74	76	78	80	82	84	86
		High Side	181	197	213	230	246	262	278	294	310	326	343
	80° DB / 67° WB	Low Side	71	73	75	77	79	81	83	85	87	89	91
		High Side	186	202	219	235	252	268	285	302	318	335	351
	85° DB / 72° WB	Low Side	77	79	81	83	85	87	89	91	93	95	97
		High Side	191	208	226	243	260	278	295	312	330	347	364
BC36B Rated CFM 1100	75° DB / 62° WB	Low Side	63	66	68	70	72	74	76	78	79	81	82
		High Side	178	195	212	228	245	262	279	296	313	331	348
	80° DB / 67° WB	Low Side	66	69	72	75	78	80	82	84	85	87	88
		High Side	184	200	217	234	251	269	286	304	321	339	357
	85° DB / 72° WB	Low Side	72	75	78	81	83	86	88	90	92	94	95
		High Side	188	206	224	242	260	278	296	314	332	351	369

Low side pressure + 2 PSIG (suction line 8 inches from compressor)

High side pressure + 5 PSIG (discharge line 8 inches from compressor, liquid at base valve approximately -15 PSIG from values listed)

Tables are based upon rated CFM (airflow) across the evaporator coil. If there is any doubt as to correct operating charge being in the system, the charge should be removed, system evacuated, and recharged to serial plate instructions.