



USER'S INFORMATION MANUAL for TU SERIES FURNACES

We're pleased you've chosen our gas furnace to supply your heating needs. Please keep this manual in a safe, yet readily available place. It contains important and useful information.

ATTENTION, INSTALLER: After installing furnace, give the user:

- User's Information Manual
- Parts List
- Installation Instructions
- Warranty Information

ATTENTION, USER! Your furnace installer should give you the above four important documents relating to your furnace. Keep these as long as you do your furnace. Pass these documents on to later purchasers or furnace users. If any of the four documents are missing or damaged, contact your installer or furnace manufacturer for replacement. For efficient service, please give your furnace model and serial number, from Section 1 or from your furnace rating plate.



WARNING

If the information in this manual is not followed exactly, a fire or explosion may result causing property damage, personal injury or loss of life

- Do not store or use gasoline or other flammable vapors and liquids in the vicinity of this or any other appliance.
- **WHAT TO DO IF YOU SMELL GAS**
 - Do not try to light any appliance.
 - Do not touch any electrical switch; do not use any phone in your building.
 - Immediately call your gas supplier from a neighbor's phone. Follow the gas supplier's instructions.
 - If you cannot reach your gas supplier, call the fire department.
- Installation and service must be performed by a qualified installer or the gas supplier.



WARNING

Read and follow all safety information in this manual, operating instructions and furnace safety labels. Failure to follow safety precautions could result in damage, injury or death.

IMPORTANT SAFETY NOTE: You must know how to turn off gas and electricity to furnace. Your qualified installer, service agency or gas supplier can teach you to use controls and switches.



WARNING

Do not use this furnace if any part has been under water. Immediately call a qualified service technician to inspect the furnace and to replace any part of the control system and any gas control which has been underwater.

Thank you for reading these safety statements. Please read on so you will know how to maintain your furnace for years of dependable service.

MANUAL: 2100-303
SUPERSEDES:
FILE: VOL. 1, TAB 2
DATE: 10/14/97

TABLE OF CONTENTS

SECTION 1	Rating Plate Information	1
SECTION 2	Important Safety Precautions	1
SECTION 3	Understanding How Your Furnace Works	3
SECTION 4	Turning Off Furnace in an Emergency	4
SECTION 5	Operating Your Furnace	6
SECTION 6	Proper Maintenance of Your Furnace	7

SECTION 1 • RATING PLATE INFORMATION

Record the manufacturer's name, unit model number and serial number below. These are your furnace rating plate. Record installation date which is important for warranty purposes.

YOUR FURNACE INFORMATION

Furnace Type _____

Manufacturer's Name _____

Model Number _____

Serial Number _____

Date Installed _____

Installer/Service _____

Address _____

City/State/Zip Code _____

Telephone Number _____

SECTION 2 • IMPORTANT SAFETY PRECAUTIONS

2.A HAZARD ALERT SYMBOL



An exclamation point surrounded by a triangle.

2.B SIGNAL WORDS

Years of safe, dependable service are assured when you understand and follow all safety precautions.

REMEMBER: Your furnace contains flames, gas, electricity, rotating parts and metal edges.

Signal words "**WARNING**" and "**CAUTION**" alert you to potential hazards.

"**WARNING**" indicates a potentially hazardous situation which, if not avoided, could result in death or serious injury.

"**CAUTION**" indicates a potentially hazardous situation which, if not avoided, may result in minor or moderate injury. It may also be used to alert against unsafe practices. It can also be used to signal property damage only potential.

2.B. SAFETY PRECAUTIONS

These are some of our most important safety precautions; others are throughout this manual. Please read and follow them.

2.1 GAS AND COMBUSTION PRODUCTS



WARNING

Any condition that will allow gas of combustion products to enter furnace area can cause nausea, asphyxiation or fire resulting in damage, injury or death.

Natural gas and propane (LP) gas have characteristic odors. When your furnace is operating correctly, you should not smell any unfamiliar odor. Normally, burning gas with air produces combustion products which contain carbon dioxide, oxygen and water vapor. Under abnormal conditions, combustion products and contain aldehydes and carbon monoxide.

- Aldehydes have a strong pungent, acrid smell that can cause nausea.
- Carbon monoxide is tasteless, colorless and odorless. It can cause headaches, flu-like symptoms or nausea. We refer to all these symptoms as nausea in this manual. It can also cause death by asphyxiation.



WARNING

Any unfamiliar smell can alert you to presence of gas or aldehydes. If you detect any unfamiliar odor follow instruction in Section 4.B.1. Otherwise, nausea, asphyxiation or fire could occur resulting in damage, injury or death.



WARNING

Do not block or cover combustion openings in the furnace door or closet door. Blocking or covering these openings could cause nausea, asphyxiation or fire resulting in damage, injury or death.



WARNING

Do not block or cover any openings from outside the furnace area which supply combustion and ventilation air to your furnace. Keep insulation away from these openings. Blocking or covering these openings could cause nausea, asphyxiation or fire resulting in damage, injury or death.



WARNING

A loud noise may mean faulty burner ignition. If your furnace makes a loud noise, turn it off. Follow instructions in Section 4.B.2. If you don't turn off your furnace, it could cause fire or an explosion resulting in damage, injury or death.



WARNING

If your furnace is in an attic or other insulated space, keep all insulating materials at least 12 inches away from its burner combustion air openings. Blocking or covering these openings could cause nausea, asphyxiation or fire resulting in damage, injury or death. Examine furnace area when the furnace is installed or when insulation is added to that area. Insulation materials may be combustible.



WARNING

Do not operate furnace with blower door open or removed. Do not alter furnace to allow operation with blower door removed. Doing either could allow combustion products to circulate throughout the furnace area causing nausea, asphyxiation or fire resulting in damage, injury or death.



WARNING

Front door must be in place during furnace operation. Hot surfaces behind front door.

2.2 STORAGE AND USE OF FLAMMABLE, CORROSIVE AND COMBUSTIBLE PRODUCTS NEAR YOUR FURNACE



WARNING

Never store or use flammable liquids or vapors near or on your furnace. These include gasoline, kerosene, cigarette lighter fluid, cleaning fluids, solvents, paint thinners or painting compounds. Flammable vapors can travel great distances before igniting.



WARNING

Never store or use anything near or on your furnace that can produce vapors that are corrosive to gas-fired furnaces. Vapors from products containing chlorines, fluorines, bromines and iodines can cause vent system or heat exchanger failure. Examples of such products are spray or aerosol containers, detergents, bleaches, cat litter, waxes, adhesives, solvents and other cleaning compounds. Vent system or heat exchanger failure could cause nausea, asphyxiation or fire resulting in damage, injury or death.



WARNING

Never store anything combustible near or on your furnace. These include brooms, dustmops, vacuum cleaners, other cleaning tools or items, plastic or plastic containers, paper bags or other paper products. A fire could occur resulting in damage, injury or death.

B.3. ALTERATION OF FURNACE CONTROLS



WARNING

Do not alter any gas or electrical controls (gas control, pilot or safety controls) in any manner. Altering them could cause furnace to operate unsafely resulting in damage, injury or death.

SECTION 3 • UNDERSTANDING HOW YOUR FURNACE WORKS

Your installer should have given you a detailed explanation of how the furnace operates. Shown below are the basic operation characteristics and sequence of operation. If you have any questions consult your installer and/or service agency.

* * IMPORTANT * *

There are many types of thermostats compatible with this furnace. Make sure you understand the specific type installed. Ask installer for detailed explanation, and retain thermostat instruction manual for reference.

This furnace is equipped with a vent shut-off system which monitors the combustion air into the burners by means of a pressure sensing device. When the vent or air intake pipes become blocked, this device turns off the gas valve circuit to prevent flue products from entering the structure. In the event that this occurs, shut off furnace and contact a qualified service agency.

3.1 BASIC FURNACE – HEATING CYCLE

This furnace is operated by an Integrated Furnace Control (IFC) which controls all functions of the furnace.

On a call for heat from the thermostat, the IFC first turns on the inducer motor. The pressure switch then closes signaling the IFC to proceed with ignition function.

There is a 36 second ignitor heat-up period, then the gas valve opens introducing main burner gas to be ignited by the hot surface ignitor. The flame sensor proves ignition and carryover across all burners.

There is a 30 second delay after main burner is on until the comfort air blower starts on heating speed. After the thermostat is satisfied, the burners will go off as gas valve closes. The inducer will continue to run for 30 seconds, and the comfort air blower will continue to run approximately two minutes.

3.2 ACCESSORIES (OPTIONAL, FIELD INSTALLED)

The furnace and IFC are designed to accommodate both electronic air cleaner and humidifier. The electronic air cleaner circuit is powered anytime the comfort air blower runs on either heating or cooling speed. The humidifier circuit is powered anytime the inducer motor is operating.

3.3 COOLING CYCLE OPERATION

If optional add-on air conditioning system is installed, the comfort air blower runs on cooling speed will run continuously during the call for cool; and will stop 60 seconds after the thermostat is satisfied.

3.4 MANUAL FAN (CONTINUOUS AIRFLOW) OPERATION

If wall thermostat is set to MANUAL (ON) position to operate comfort air blower continuously to provide air circulation throughout the building, the blower will operate on the heating speed rather than the cooling as is typical with most systems. This permits the air to circulate as desired but helps keep the operating noise level down as well as conserving energy.

During a call for cooling, the blower automatically shifts up to cooling speed, and remains there until 60 seconds after thermostat is satisfied then drops back to heating speed.

SECTION 4 • TURNING OFF FURNACE IN AN EMERGENCY

WARNING

Have a qualified installer, service agency or gas supplier teach you location and operation of gas and electrical shutoff devices. Ask them any questions you have about this section. If you don't turn off your furnace in an emergency damage, injury or death could result.

In an emergency you *MUST* know how to turn off gas and electricity. Find out how *BEFORE THE EMERGENCY*.

WARNING

Should overheating occur or the gas supply fail to shut off, shut off the manual gas valve to the furnace before shutting off the electrical supply. Failure to do so can cause a fire or explosion which could result in damage, injury or death.

4.A GAS AND ELECTRICAL SHUTOFF DEVICES

1. GAS SHUTOFF DEVICES

In an emergency, you may not be able to reach all the gas shutoff devices. You must know how to turn off gas using any one of the three manual types:

a. Manual Shutoff Knob on Gas Control

Gas control location is behind door. See Lighting and Shutdown Instructions in Section 5 for more information.

To turn gas control furnace knob **OFF**, turn it clockwise ↻. Use this same procedure when you leave a vacation home vacant and do not want the furnace to operate.

b. Manual In-Line Shutoff Valve in Gas Supply Line

This valve is next to furnace. Figure 1 shows a typical installation.

Normally, gas is **ON** when you turn the shutoff valve handle parallel to gas pipe. Gas is **OFF** when you turn handle 90° from gas pipe.

FIGURE 1 – TYPICAL GAS PIPING

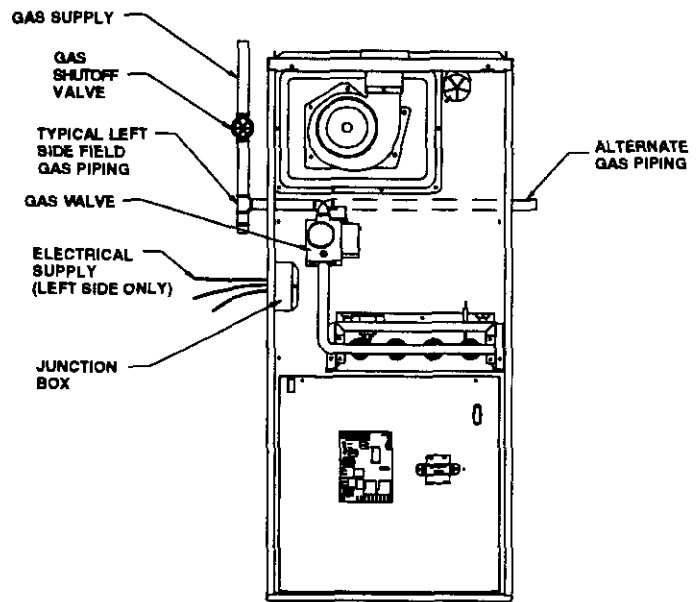
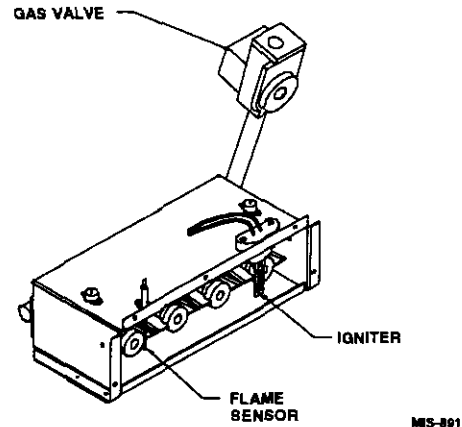

c. Manual Shutoff Valve at Natural Gas Meter or Propane (LP) Gas Tank

Normally, natural gas is **ON** when you turn shutoff parallel to gas pipe. Gas is **OFF** when you turn shutoff 90° from gas pipe. Some valves require a wrench or other tools.

2. ELECTRICAL SHUTOFF DEVICES

In an emergency, you may not be able to reach both of your electrical shutoff devices. Therefore, you must know how to turn off electricity using either one of them. Here are two types of electrical shutoff devices:

- There should be an electrical shutoff device located on or immediately adjacent to the furnace.
- There should be a separate circuit breaker or fuse serving only the furnace located in the main circuit breaker or fuse panel. Know its location and make sure this device is clearly identified.

4.B POSSIBLE EMERGENCIES AND RECOMMENDED ACTIONS

 WARNING
If gas or electricity is off due to an emergency, only a qualified installer, service agency or gas supplier should turn it back on. Doing it yourself could result in damage, injury or death.

1. **Possible Emergency:** Smelling gas or other unfamiliar smell; or not knowing what may be wrong or that to do about it.

ACTION: For your safety –

- a. Leave your house or building immediately.
- b. Go to a neighbor's or another building.
- c. Use their telephone.
- d. Call your gas supplier. Tell them you smell gas and give them your name and address.
- e. If you cannot reach gas supplier, call fire department.

 WARNING
Three important things not to do – <ol style="list-style-type: none">1. Don't try to light any gas appliances.2. Don't touch any electrical switches3. Don't use the telephone in your house or building. Any of the above may cause a spark which could cause a fire or explosion resulting in damage, personal injury or death.

2. **Possible Emergency:** Your thermostat is set below room temperature; yet even though the blower is on, the air coming from your room registers continually gets hotter.

ACTION:

- a. Turn room thermostat to its lowest or OFF setting.
- b. If you can do so safely, turn gas off. Use manual shutoff valve at gas meter or on propane (LP) gas tank. You may need a wrench or tools. If you can safely turn off electricity at the main circuit circuit panel, do so. If you cannot do these things safely, leave your home or building immediately. Call your gas supplier or fire department from a neighbor's phone for help.

- c. Your furnace should now be off. If it is, call your service technician or gas supplier.
- d. If your furnace continues to run, leave your home or building immediately. Call your gas supplier or fire department from a neighbor's phone for help.

3. **Possible Emergency:** Your thermostat is set above room temperature. The blower is on but the air coming from your room registers is hot, then cold, then hot, then cold in a continuing cycle. This condition indicates lack of airflow through furnace.

ACTION:

- a. Make sure air filter is clean and installed correctly.
 - b. Check that registers and return air grilles are open and unobstructed.
 - c. If condition continues, call your local qualified service technician or gas supplier.
4. **Possible Emergency:** While furnace is operating, you smell unfamiliar odors that go away when furnace is off.

 WARNING
Unfamiliar odors may mean gas or aldehydes are present which could result in damage, injury or death.

ACTION:

- a. Turn thermostat to its lowest or OFF setting.
 - b. Move gas valve control level to OFF.
 - c. If blower is not operating, immediately turn off electricity to furnace using shutoff device near furnace or at main circuit panel.
 - d. If blower is operating, wait five minutes for furnace to cool down and then turn off electricity to furnace using shutoff device near furnace or at main circuit panel.
 - e. Call your local qualified service technician or gas supplier.
5. **Possible Emergency:** Main electrical circuit breaker for furnace cannot be reset without tripping again or new fuses continue to blow.

ACTION:

- a. Move gas valve control level to OFF.
- b. Call your local qualified service technician or gas supplier.

SECTION 5 • OPERATING YOUR FURNACE

After reading the Safety Information and Precautions follow Operating Instructions on front door of furnace and instructions repeated here.

WARNING

If you do not follow these instructions exactly a fire or explosion could occur resulting in damage, injury or death.

WARNING

Never use tools to turn gas control knob. Only use your hand. If gas control knob will not turn by hand, do not force it or try to repair it. Call a qualified installer, service agency or gas supplier. Forcing knob can cause gas to leak which could result in fire or explosion.

Properly operating your furnace requires certain abilities, mechanical skills and tools. If you are uncertain about your abilities or if you lack proper skills or tools, do not proceed. Instead, contact a qualified installer, service agency or gas supplier.

An automatic ignition device lights the burners. Do not try to light manually. See Figure 2 for step by step instructions.

FIGURE 2

FOR YOUR SAFETY READ BEFORE OPERATING

WARNING: If you do not follow these instructions exactly, a fire or explosion may result causing property damage, personal injury or loss of life.

A. This appliance does not have a pilot. It is equipped with an ignition device which automatically lights the burner. Do NOT try to light the burner by hand.

B. BEFORE OPERATING smell all around the appliance area for gas. Be sure to smell next to the floor because some gas is heavier than air and will settle on the floor.

WHAT TO DO IF YOU SMELL GAS

- * Do not try to light any appliances.
- * Do not touch any electric switch; do not use any phone in your building.
- * Immediately call your supplier from a neighbor's phone. Follow the gas supplier's instructions.

* If you cannot reach your gas supplier; call the fire department.

C. Use only your hand to push in or move the gas control lever. Never use tools. If the lever will not push in or turn by hand, don't try to repair it, call a qualified service technician. Force or attempted repair may result in a fire or explosion.

D. Do not use this appliance if any part has been under water. Immediately call a qualified service technician to inspect the appliance and to replace any part of the control system and any gas control which has been under water.

OPERATING INSTRUCTIONS

1. STOP! Read the safety information above on this label.
2. Set the thermostat to lowest setting.
3. Turn off all electric power to the appliance.
4. This appliance is equipped with an ignition device which automatically lights the burner. Do NOT try to light the burner by hand.
5. Remove control access panel.
6. Push in gas control knob slightly and turn clockwise  to "OFF".

NOTE: Knob cannot be turned to "OFF" unless knob is pushed in slightly. Do not force.

7. Wait five (5) minutes to clear out any gas. Then smell for gas, including near the floor. If you smell gas, STOP! Follow "B" in the safety information above on this label. If you don't smell gas, go to the next step.
8. Turn gas control knob counterclockwise  to "ON".
9. Replace control access panel.
10. Turn on all electric power to the appliance.
11. Set thermostat to desired setting.
12. If the appliance will not operate, follow the instructions "To Turn Off Gas To Appliance" and call your service technician or gas supplier.

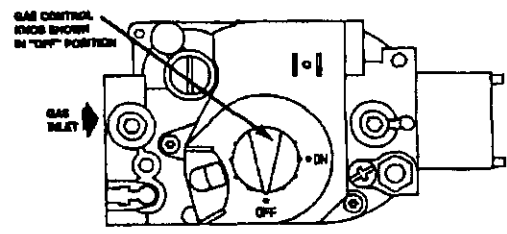

TO TURN OFF GAS TO APPLIANCE

1. Set the thermostat to lowest setting.
2. Turn off all electric power to the appliance if service is to be performed.
3. Remove control access panel.
4. Push in gas control lever slightly and move to "OFF". Do not force.
5. Replace control access panel.

7960-509

SECTION 6 • PROPER MAINTENANCE OF YOUR FURNACE

You need special abilities, mechanical skills and tools to maintain your furnace properly. If you are uncertain about your abilities or if you lack proper skills or tools, do not try to maintain or repair you furnace yourself. Instead, contact a qualified installer, service agency or gas supplier.

6.A IF YOU SMELL GAS OR ANY UNFAMILIAR SMELL WHILE WORKING ON YOUR FURNACE:

1. Do not try to light main burners.
2. Do not touch or turn on any electrical switch.
3. Do not use any phone in your building.
4. Immediately call your gas supplier from a neighbor's phone. Follow gas supplier's instructions.
5. If you cannot reach your gas supplier, call fire department.

6.B LUBRICATION REQUIREMENTS

The main blower motor and the induced draft blower motor are permanently lubricated, and no maintenance is required.

6.C MAKE SURE AIR FILTER(S) IS IN PLACE

Ask your installer, local qualified service technician or gas supplier to make sure your filter(s) is in place properly. Become familiar with its location and procedures for removing, cleaning and replacing it.

Recommended filter sizes are shown below.

Model	Size	Quantity	Filter Rack
TU042	16 x 25 x 1	1	FR23
TU063	16 x 25 x 1	1	FR23
TU084	16 x 25 x 1	1	FR23
TU105	16 x 25 x 1	2 ‡	FR23
	20 x 25 x 1	1	FR24
TU126	16 x 25 x 1	2 ‡	FR23
	20 x 25 x 1	1	FR24

‡ For 5 Ton cooling applications, two 16x25x1 filters (one per return drop) are required to maintain proper flow velocities. If one return drop is used, a 20x25x1 filter and the appropriate 20x25 filter rack must be used. These items are available through your dealer.

WARNING

Operating furnace without clean air filter(s) can damage blower motor, heat exchanger or air conditioning system components. This can cause system failure which could result in damage or injury.

6.D KEEP AIR FILTER(S) CLEAN

As a user, your personal responsibility is to keep air filter(s) clean.

CAUTION

A dirty air filter(s) reduces system efficiency and can cause erratic control performance. These could result in damage to blower motor or heat exchanger.

1. During the first four weeks after your furnace is installed, inspect your air filter(s) for dirt every week. Then check the filters monthly and clean as necessary.
2. If the filter(s) is of a washable type, clean filter(s) according to the manufacturer's specifications.

WARNING

After cleaning or changing filter(s), filter access cover(s) must be replaced. Failure to do so could cause nausea, asphyxiation, or fire resulting in damage, injury or death.

6.E DO NOT OBSTRUCT DUCT WORK

For proper operation, keep registers and return air grilles open. Do not cover or block them with rugs, carpets, drapes or furniture.

6.F HAVE YOUR FURNACE CHECKED ANNUALLY

The furnace and the vent, and the combustion air intake piping system (if provided) should be inspected yearly by a qualified service agency, generally prior to the heating season. Detailed procedures for this inspection are contained in the instructions booklet and should be handled by the qualified service agency only.

A general inspection of the furnace, the furnace area and the vent piping system should be conducted on a regular basis by the owner/occupant. This review should include:

1. Make sure the furnace always has the minimum clearance as detailed on the furnace rating plate. Special attention must be given to these items if any remodeling is done.
2. Make sure the vent piping system is in place and is physically sound without holes, sags or dips.
3. Reviewing that the return air duct connection(s) is physically sound, is sealed to the furnace casing, and terminates outside the space containing the furnace.
4. The physical support of the furnace is sound without sagging, cracks, gaps, etc. around the base so as to provide a seal between the support and the base.
5. Inspect for any obvious signs of deterioration of the furnace.
6. Periodic examinations of the vent piping system should also be conducted by the owner on a regular basis, preferably every monthly but at least every two months during the heating season.
7. Check the entire vent system for any blockage. If any debris is present remove it.
8. Make sure that vent connector from the furnace slopes upward and is physically sound without holes or excessive corrosion.

6.G THE FOLLOWING PROCEDURE SHOULD BE FOLLOWED FOR THE PERIODIC INSPECTION AS CONDUCTED BY THE OWNER/OCCUPANT.

1. Set the wall thermostat to the OFF position or lower the set point lever to a temperature will below the existing room temperature. Shut off electric power to the furnace. A switch should be mounted either on the outside of the furnace or adjacent to the furnace for this purpose.
2. Remove the outer panel that has ventilating slots in it.
3. Use flashlight or trouble light to observe the burner compartment and burners. There should be very minimal scaling or sooting in this area. Some loose debris may have fallen down on to the floor of the heat exchanger from the tube passageways, and this may be vacuumed out. Also observe the sides of the heat exchanger tubes for "hot spots" due to improper burner alignment or overfiring and give particular attention to any area where it looks like there may be any deterioration from corrosion or

rusting. Observe for any corrosion on the burners themselves. Should anything appear questionable, contact your service agency.

4. Inspect the vent pipe the full distance from the furnace to the vent terminal; observing for any possible leakage that might result in products of combustion entering the living area.



WARNING

Leakage of products of combustion into the living area may result in asphyxiation resulting in injury or death

5. Restore the electrical power to the furnace by turning the switch back on. Adjust the thermostat to call for heating operation.
6. Observe the main burners in operation. The flame should be mostly "blue" with possibly a little "orange" at the tips of the flames. The flames should be in the center of the heat exchanger tubes and not impinging on the sides of the tubes themselves. Refer to Figure 3.
7. Observe the fire until the blower starts (there is a normal delay period until the heat exchanger warms up). There should be no change in the size or shape of the flame. If there is any wavering or blowing of the flame on the blower start-up, it is an indication of a possible leak in the heat exchanger. Turn off the gas valve in the gas line leading to the furnace, and then the main electrical switch to the furnace and call your service agency.
8. Replace the slotted outer furnace door.

FIGURE 3

