

---

INSTALLATION      INSTRUCTIONS

---

**WALL MOUNTED  
PACKAGE AIR CONDITIONERS**

**MODEL  
WA7013**



Bard Manufacturing Company  
Bryan, Ohio 43506

*Since 1914...Moving ahead, just  
as planned.*

Manual : 2100-359  
Supersedes:  
File: Volume III Tab 16  
Date: 01-26-2000

© Copyright 2000

# Contents

---

<b>Getting Other Information and Publications</b> .....	<b>1</b>
<b>Wall Mount General Information</b> .....	<b>2</b>
Air Conditioning Wall Mount Model Nomenclature ..	2
Shipping Damage .....	5
General .....	5
Duct Work .....	5
Condensate Drain .....	5
<b>Installation Instructions</b> .....	<b>6</b>
Wall Mounting Information .....	6
Mounting the Unit .....	6
Wiring – Main Power .....	11
Wiring – Low Voltage Wiring .....	11

<b>Start Up</b> .....	<b>15</b>
Important Installer Note .....	13
Crankcase Heaters .....	13
High Pressure Switch .....	13
Three Phase Scroll Compressor Start Up .....	13
Service Hints .....	13
Sequence of Operation .....	13
Compressor Control Module .....	13
Adjustments .....	14
Phase Monitor .....	14
Pressure Service Ports .....	14
<b>Troubleshooting</b> .....	<b>15</b>
Fan Blade Setting Dimensions .....	15
Removal of Fan Shroud .....	15
Refrigerant Charge .....	15
Pressure Table .....	16
Optional Accessories .....	16

## Figures

Figure 1	Unit Dimensions .....	3
Figure 2	Mounting Instructions .....	7
Figure 3	Electric Heat Clearance .....	8
Figure 4	Wall Mounting Instructions .....	9
Figure 5	Wall Mounting Instructions .....	9
Figure 6	Common Wall Mounting Installations ....	10
Figure 7	Unit 24V Terminal Board .....	12
Figure 8	Fan Blade Setting .....	15

## Tables

Table 1	Electric Heat Table .....	2
Table 2	Electrical Specifications .....	4
Table 3	Thermostat Wire Size .....	11
Table 4	Wall Thermostat and Subbase Combinations .....	11
Table 5	Fan Blade Dimensions .....	15
Table 6	Indoor Blower Performance .....	15
Table 7	Refrigerant Charge .....	15
Table 8	Rated CFM and Rated ESP .....	15
Table 9	Maximum ESP of Operation Electric Heat Only .....	15
Table 10	Pressure Table .....	16
Table 11	Optional Accessories .....	16

# Getting Other Information and Publications

These publications can help you install the air conditioner or heat pump. You can usually find these at your local library or purchase them directly from the publisher. Be sure to consult current edition of each standard.

National Electrical Code ..... ANSI/NFPA 70

Standard for the Installation ..... ANSI/NFPA  
90A  
of Air Conditioning and  
Ventilating Systems

Standard for Warm Air ..... ANSI/NFPA  
90B  
Heating and Air  
Conditioning Systems

Load Calculation for ..... ACCA Manual J  
Residential Winter and  
Summer Air Conditioning

Duct Design for Residential ..... ACCA Manual  
D Winter and Summer Air Conditioning  
and Equipment Selection

## For more information, contact these publishers:

**ACCA**     **Air Conditioning Contractors of America**  
1712 New Hampshire Ave. N.W.  
Washington, DC 20009  
Telephone: (202) 483-9370  
Fax: (202) 234-4721

**ANSI**     **American National Standards Institute**  
11 West Street, 13th Floor  
New York, NY 10036  
Telephone: (212) 642-4900  
Fax: (212) 302-1286

**ASHRAE**   **American Society of Heating Refrigerating,  
and Air Conditioning Engineers, Inc.**  
1791 Tullie Circle, N.E.  
Atlanta, GA 30329-2305  
Telephone: (404) 636-8400  
Fax: (404) 321-5478

**NFPA**     **National Fire Protection Association**  
Batterymarch Park  
P.O. Box 9101  
Quincy, MA 02269-9901  
Telephone: (800) 344-3555  
Fax: (617) 984-7057

Manufactured under the following U.S. patent numbers:

5,485,878; 5,301,777; 5,002,116; 4,924,934;  
4,875,520; 4,825,936; 4,432,409

# WALL MOUNT GENERAL INFORMATION

## AIR CONDITIONING WALL MOUNT MODEL NOMENCLATURE

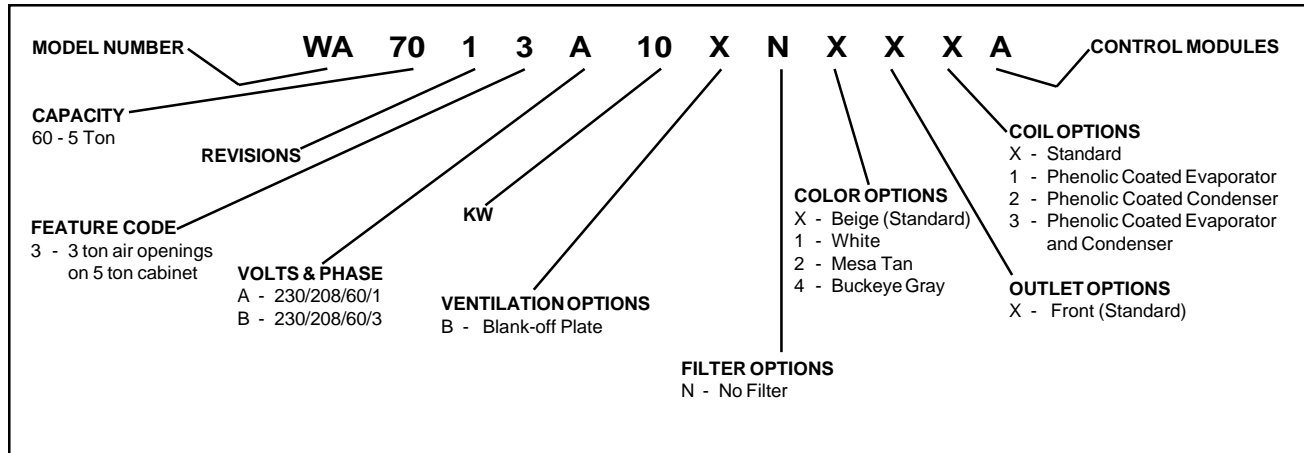

**TABLE 1  
ELECTRIC HEAT TABLE**

Models	WA7013A ONLY				WA7013B ONLY			
	240V-1		208V-1		240V-1		208V-1	
	AMPS	BTUH	AMPS	BTUH	AMPS	BTUH	AMPS	BTUH
5.0	20.8	17,050	18.1	12,800	---	---	---	---
9.0	---	---	---	---	21.7	30,600	18.7	23,030
10.0	41.6	34,130	36.2	25,600	---	---	---	---

**FIGURE 1  
UNIT DIMENSIONS**

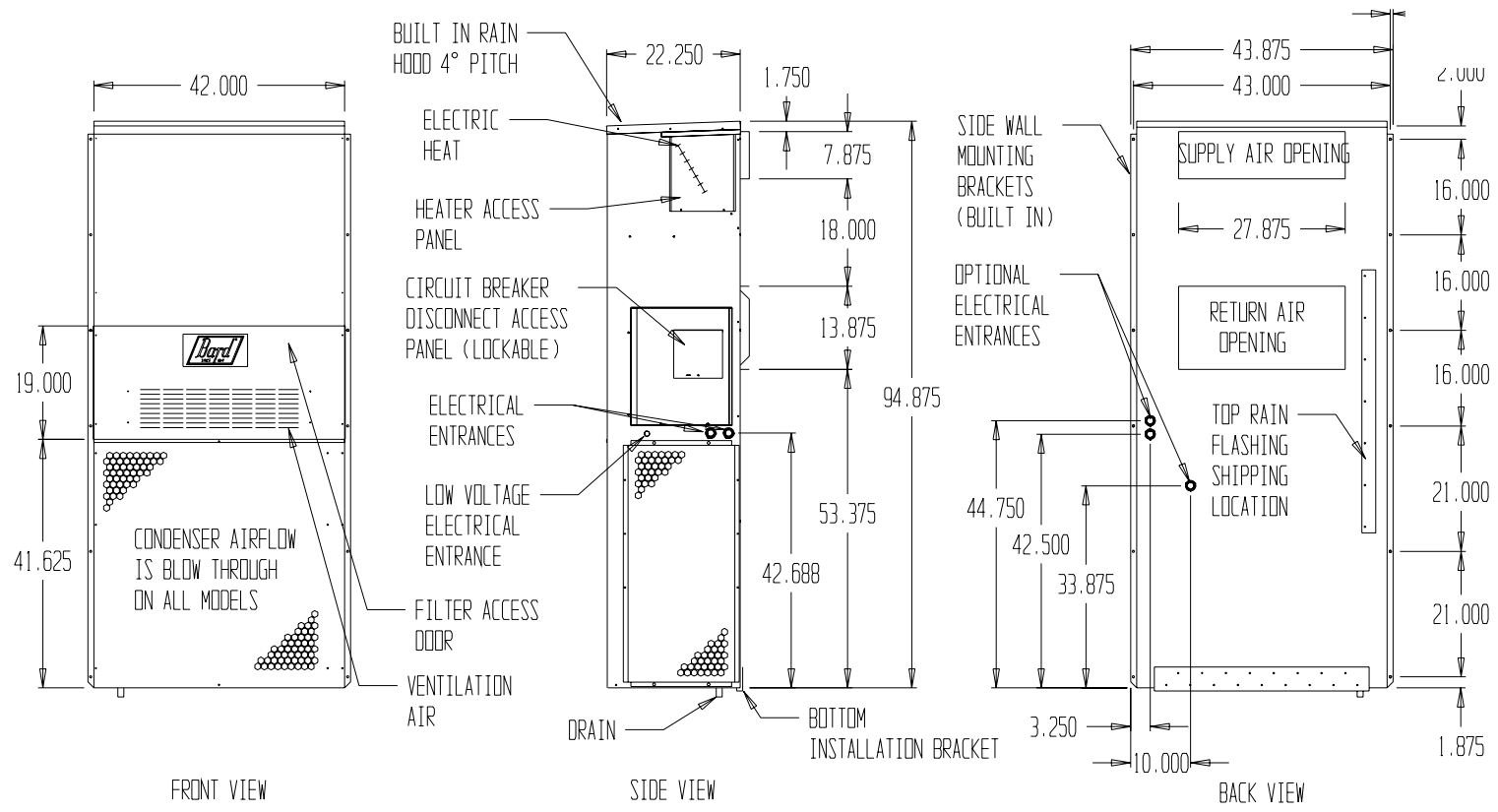

**TABLE 2  
ELECTRICAL SPECIFICATIONS**

Model	SINGLE CIRCUIT						DUAL CIRCUIT							
	Rated Volts & Phase	No. Field Power Circuits	③ Minimum Circuit Ampacity	① Maximum External Fuse or Ckt. Breaker	② Field Power Wire Size	② Ground Wire Size	③ Minimum Circuit Ampacity		① Maximum External Fuse		② Field Power Wire Size		② Ground Wire Size	
							CKT A	CKT B	CKT A	CKT B	CKT A	CKT B	CKT A	CKT B
WA7013A0Z A10	230/208-1	1	48	60	8	10	N/A	N/A	N/A	N/A	N/A	N/A	N/A	N/A
		1	59	60	6	10	N/A	N/A	N/A	N/A	N/A	N/A	N/A	N/A
W7013B0Z B09	230/208-3	1	36	50	8	10	N/A	N/A	N/A	N/A	N/A	N/A	N/A	N/A
		1	36	50	8	10	N/A	N/A	N/A	N/A	N/A	N/A	N/A	N/A

- Ⓐ Maximum size of the time delay fuse or HACR type circuit breaker for protection of field wiring conductors.
- Ⓐ Based on 75° C copper wire. All Wiring must conform to NEC and all local codes.
- Ⓐ These "minimum Circuit Ampacity" values are to be used for sizing the field power conductors. Refer to the National Electric Code (latest revision), article 310 for power conductor sizing. *CAUTION: When more than one field power conductor circuit is run through one conduit, the conductors must be derated. Pay special attention to note 8 of table 310 regarding Ampacity Adjustment Factors when more than 3 conductors are in a raceway.*

## SHIPPING DAMAGE

Upon receipt of equipment, the carton should be checked for external signs of shipping damage. If damage is found, the receiving party must contact the last carrier immediately, preferably in writing, requesting inspection by the carrier's agent.

## GENERAL

The equipment covered in this manual is to be installed by trained, experienced service and installation technicians.

The refrigerant system is completely assembled and charged. All internal wiring is complete.

The unit is designed for use with or without duct work. Flanges are provided for attaching the supply and return ducts.

These instructions explain the recommended method to install the air cooled self-contained unit and the electrical wiring connections to the unit.

While these instructions are intended as a general recommended guide, they do not supersede any national and/or local codes in any way. Authorities having jurisdiction should be consulted before the installation is made. See Page 1 for information on codes and standards.

Size of unit for a proposed installation should be based on heat loss calculation made according to methods of Air Conditioning Contractors of America (ACCA). The air duct should be installed in accordance with the Standards of the National Fire Protection Association for the Installation of Air Conditioning and Ventilating Systems of Other Than Residence Type, NFPA No. 90A, and Residence Type Warm Air Heating and Air Conditioning Systems, NFPA No. 90B. Where local regulations are at a variance with instructions, installer should adhere to local codes.

## DUCT WORK

All duct work, supply and return, must be properly sized for the design air flow requirement of the equipment. Air Conditioning Contractors of America (ACCA) is an excellent guide to proper sizing. All duct work or portions thereof not in the conditioned space should be properly insulated in order to both conserve energy and prevent condensation or moisture damage.

These instructions and any instructions packaged with any separate equipment, required to make up the entire air conditioning system should be carefully read before beginning the installation. Note particularly any tags and/or labels attached to the equipment.

Design the duct work according to methods given by the Air Conditioning Contractors of America (ACCA). When duct runs through unheated spaces, it should be insulated with a minimum of one inch of insulation. Use insulation with a vapor barrier on the outside of the insulation. Flexible joints should be used to connect the duct work to the equipment in order to keep the noise transmission to a minimum.

A 1/4 inch clearance to combustible material for the first three feet of duct attached to the outlet air frame is required. See Wall Mounting Instructions and Figures 3 and 3A for further details.

Ducts through the walls must be insulated and all joints taped or sealed to prevent air or moisture entering the wall cavity.

Some installations may not require any return air duct. A metallic return air grille is required with installations not requiring a return air duct. The spacing between louvers on the grille shall not be larger than 5/8 inch.

*NOTE: If no return air duct is used, applicable installation codes may limit this cabinet to installation only in a single story structure.*

Any grille that meets with 5/8 inch louver criteria may be used. It is recommended that Bard Return Air Grille Kit RG2 through RG5 or RFG2 through RFG5 be installed when no return duct is used. Contact distributor or factory for ordering information. If using a return air filter grille, filters must be of sufficient size to allow a maximum velocity of 400 fpm.

## CONDENSATE DRAIN

A plastic drain hose extends from the drain pan at the top of the unit down to the unit base. There are openings in the unit base for the drain hose to pass through. In the event the drain hose is connected to a drain system of some type, it must be an open or vented type system to assure proper drainage.

# INSTALLATION INSTRUCTIONS

---

## WALL MOUNTING INFORMATION

1. Two holes for the supply and return air openings must be cut through the wall as shown in Figure 1.
2. On wood frame walls, the wall construction must be strong and rigid enough to carry the weight of the unit without transmitting any unit vibration.

### **WARNING**

Fire hazard can result if 1/4 inch clearance to combustible materials for supply air duct is not maintained. See Figure 2.

3. Concrete block walls must be thoroughly inspected to insure that they are capable of carrying the weight of the installed unit.

## MOUNTING THE UNIT

1. These units are secured by wall mounting brackets which secure the unit to the outside wall surface at both sides. A bottom mounting bracket is provided for ease of installation, but is not required.
2. The unit itself is suitable for 0 inch clearance, but the supply air duct flange and the first 3 feet of supply air duct require a minimum of 1/4 inch clearance to combustible material. If a combustible wall use a minimum of 30-1/2" x 10-1/2" dimensions for sizing. However it is generally recommended that a 1 inch clearance is used for ease of installation and maintaining the required clearance to combustible material. The supply air opening would then be 32" x 12". See Figures 2 and 3 for details.

### **WARNING**

Failure to provide the 1/4 inch clearance between the supply duct and a combustible surface for the first 3 feet of duct can result in fire causing damage, injury or death.

3. Locate and mark lag bolt locations and bottom mounting bracket location. See Figure 2.
4. Mount bottom mounting bracket.
5. Hook top rain flashing under back bend of top. Top rain flashing is shipped secured to the right side of the back.
6. Position unit in opening and secure with 5/16 lag bolts; use 7/8 inch diameter flat washers on the lag bolts.
7. Secure rain flashing to wall and caulk across entire length of top. See Figure 2.
8. For additional mounting rigidity, the return air and supply air frames or collars can be drilled and screwed or welded to the structural wall itself (depending upon wall construction). Be sure to observe required clearance if combustible wall.
9. On side by side installations, maintain a minimum of 20 inches clearance on right side to allow access to control panel and heat strips, and to allow proper airflow to the outdoor coil. Additional clearance may be required to meet local or national codes.



**FIGURE 2  
MOUNTING INSTRUCTIONS**

REQUIRED DIMENSIONS TO MAINTAIN 1/4" MIN. CLEARANCE FROM COMBUSTIBLE MATERIALS	A	B	C	D	E
	28 1/2	8 1/2	7 1/4	1 1/4	17 1/2
REQUIRED DIMENSIONS TO MAINTAIN RECOMMENDED 1" CLEARANCE FROM COMBUSTIBLE MATERIALS	30	10	6 1/2	2	16 3/4

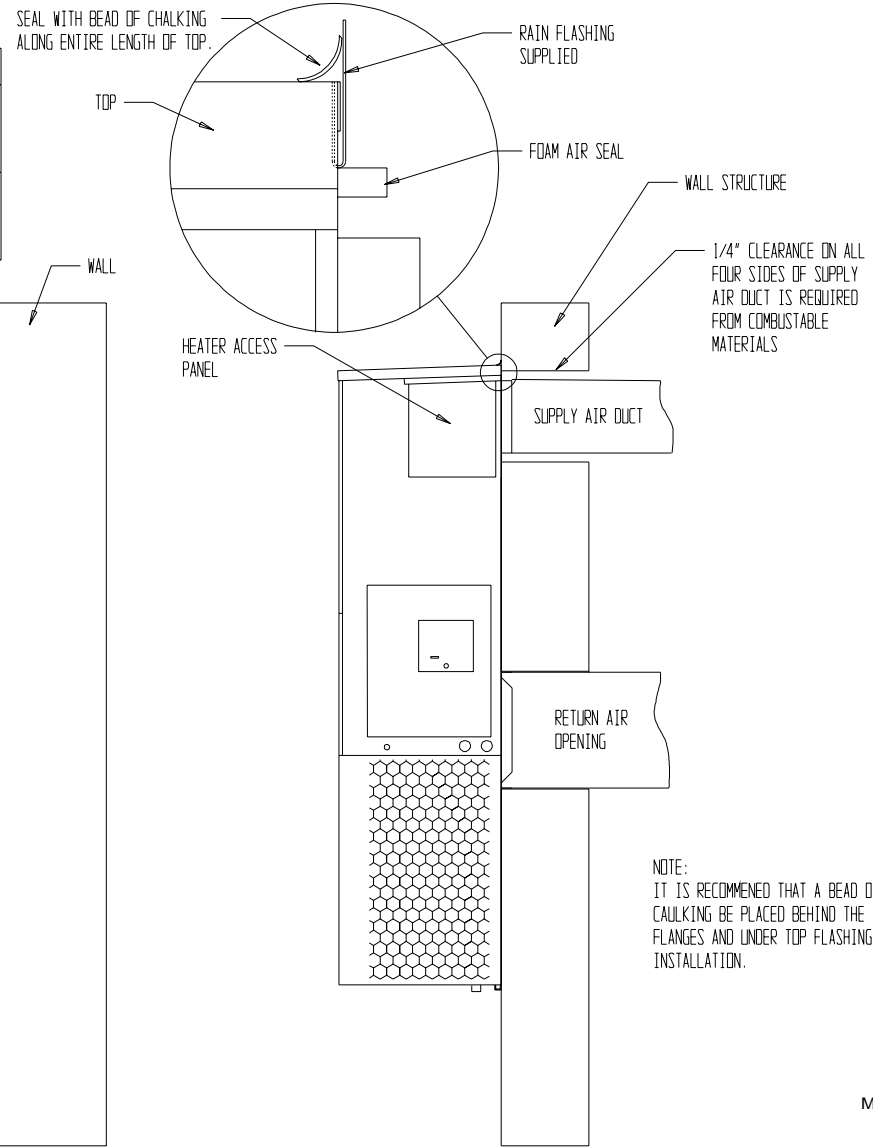
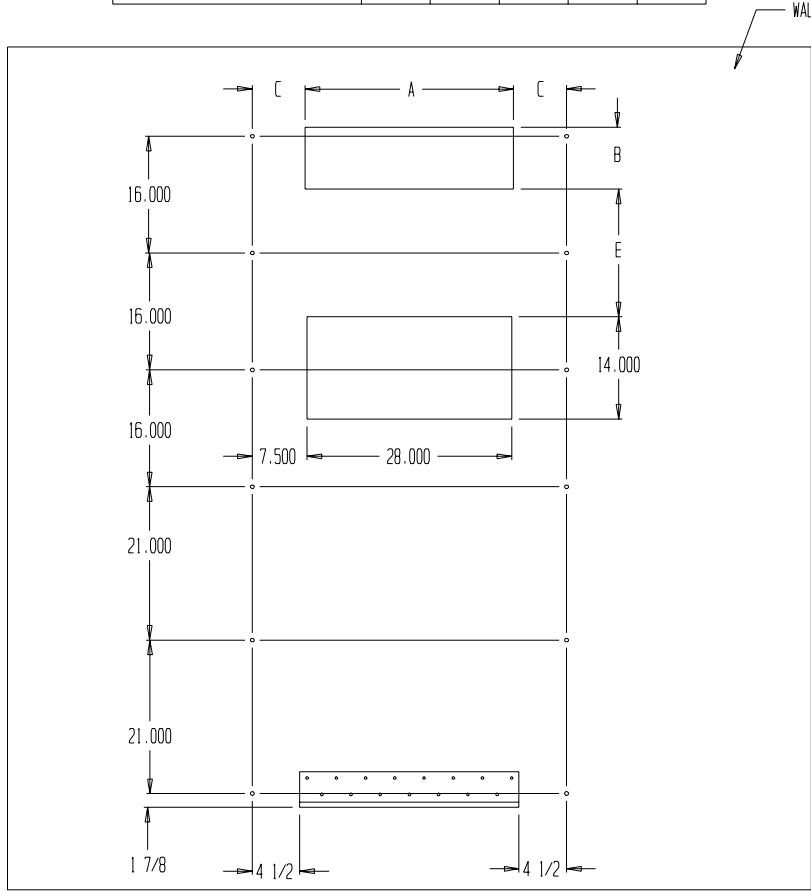

NOTE:  
IT IS RECOMMENDED THAT A BEAD OF SILIC CAULKING BE PLACED BEHIND THE SIDE MC FLANGES AND UNDER TOP FLASHING AT TI<sub>1</sub> INSTALLATION.

MIS-1445

**FIGURE 3**  
**ELECTRIC HEAT CLEARANCE**

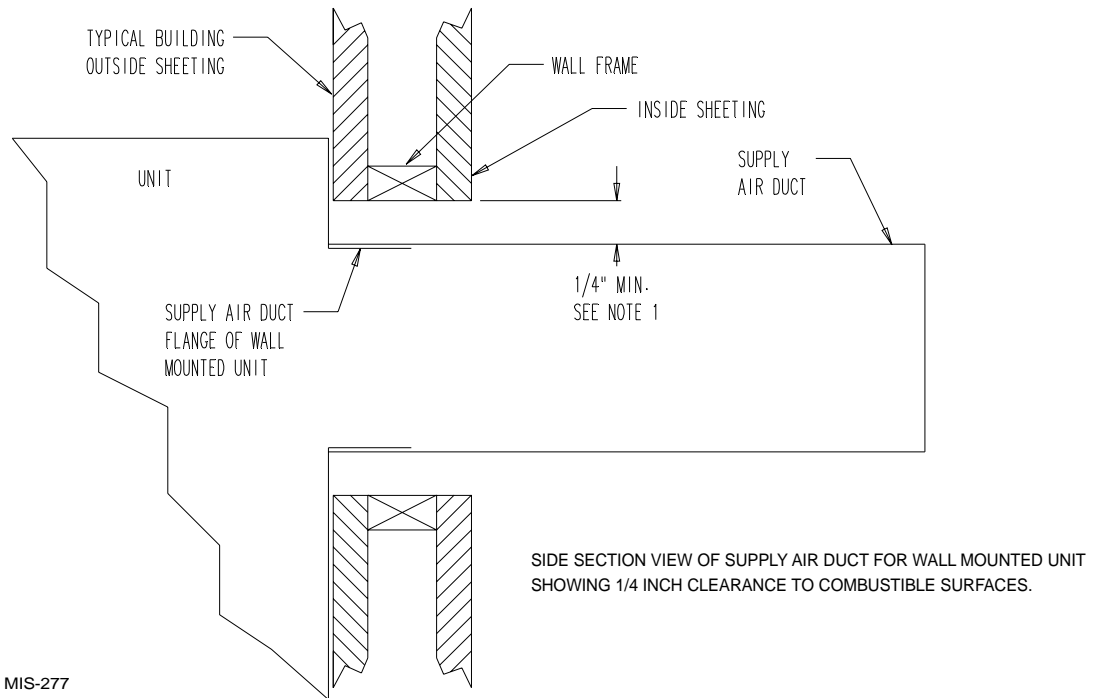

## WARNING

A **minimum** of 1/4 inch clearance must be maintained between the supply air duct and combustible materials. This is required for the first 3 feet of ducting.

It is important to insure that the 1/4 inch minimum spacing is maintained at all points.

Failure to do this could result in overheating the combustible material and may result in a fire causing damage, injury or death.

**FIGURE 4**  
**WALL MOUNTING INSTRUCTIONS**

SEE FIGURE 3 – MOUNTING INSTRUCTIONS

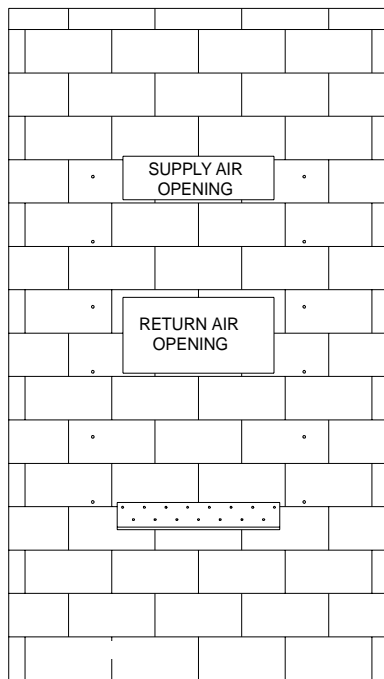

CONCRETE BLOCK WALL INSTALLATION

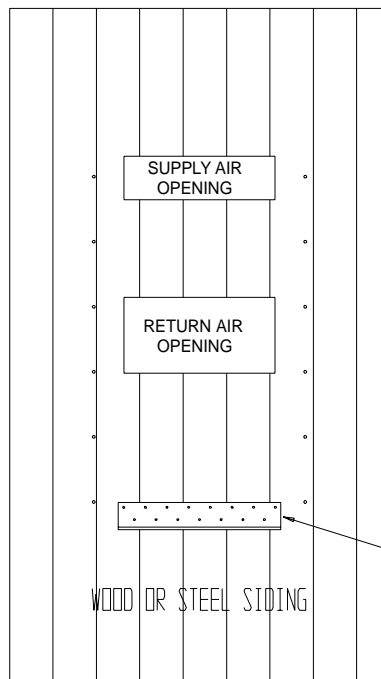

WOOD FRAME WALL INSTALLATION

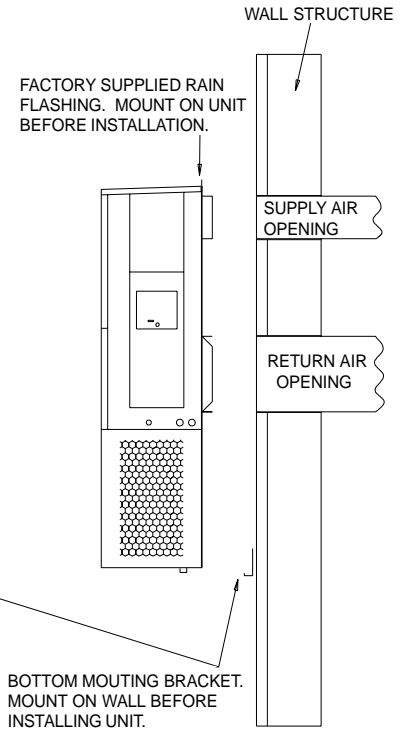

MIS-1548

**FIGURE 5**  
**WALL MOUNTING INSTRUCTIONS**

SEE UNIT DIMENSIONS, FIGURE 1, FOR ACTUAL DIMENSIONS

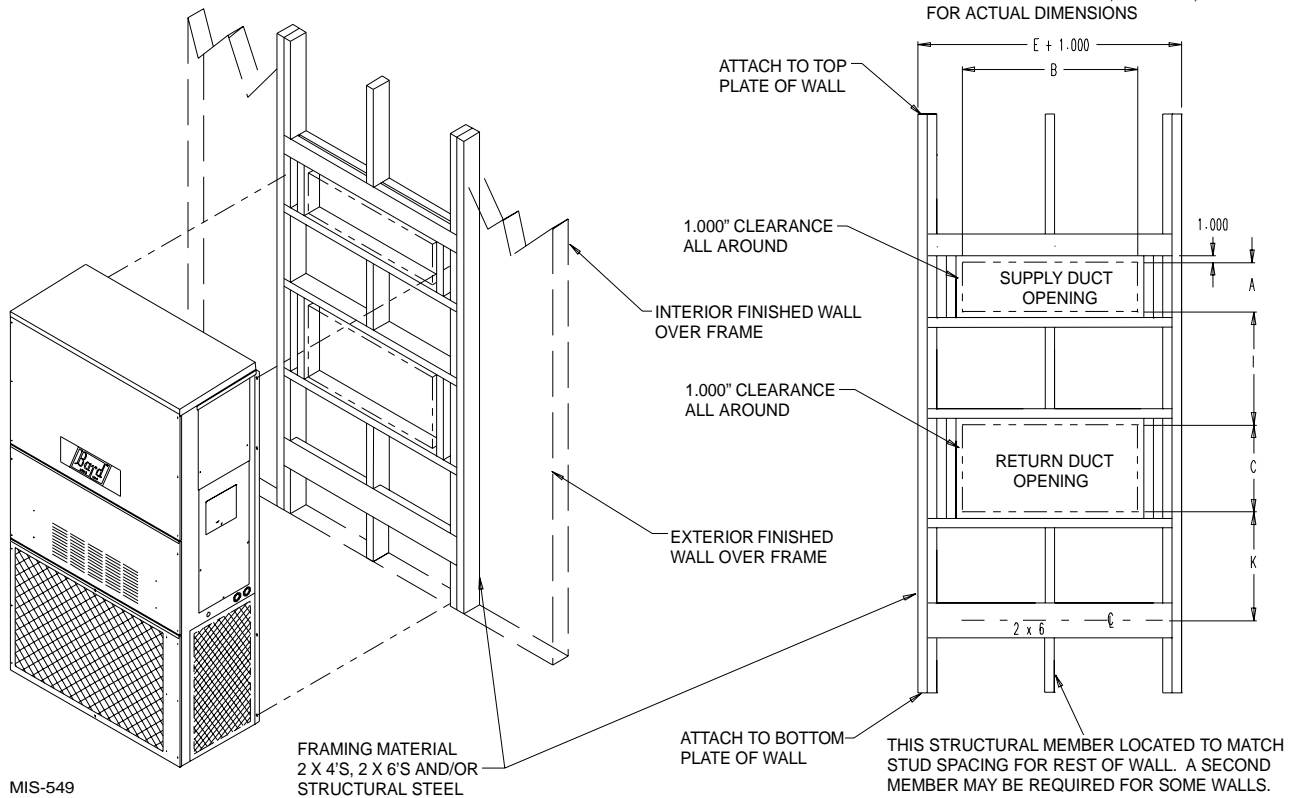

MIS-549

**FIGURE 6  
COMMON WALL MOUNTING INSTALLATIONS**

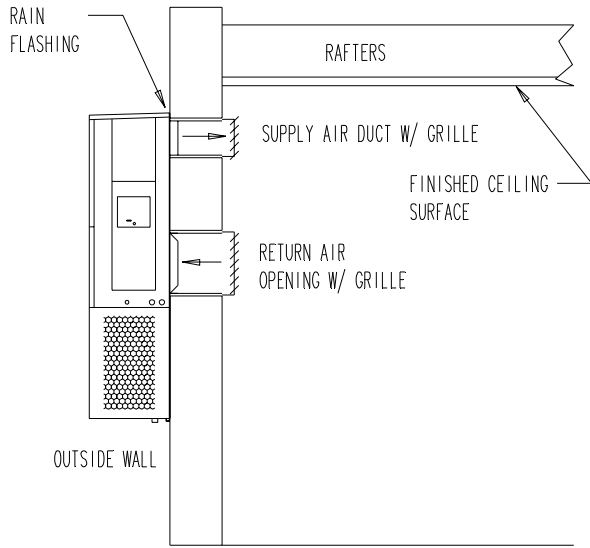

**FREE AIR FLOW NO DUCT**

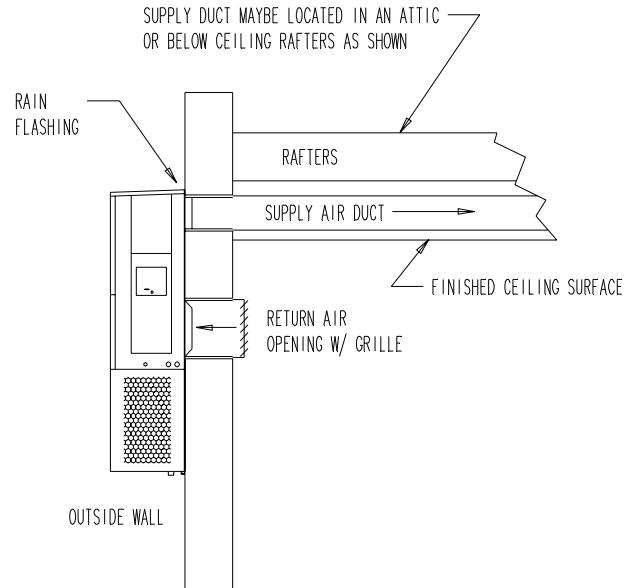

**DUCTED SUPPLY RETURN AT UNIT**

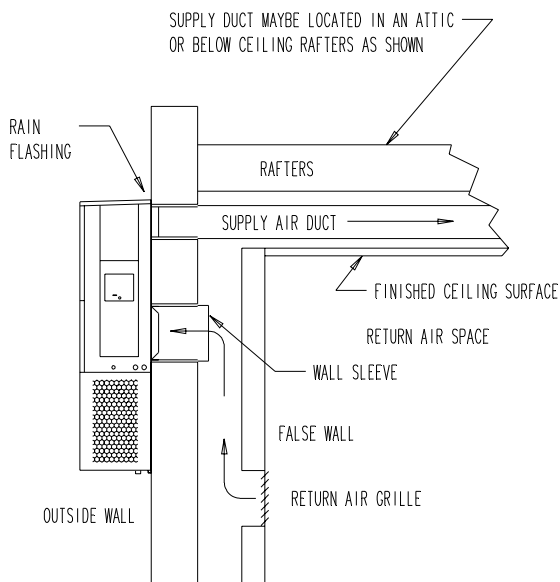

**FALSE WALL INSTALLATION**

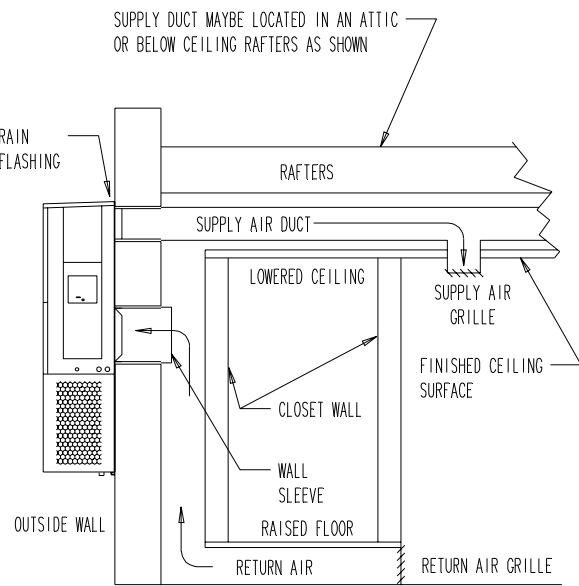

**CLOSET INSTALLATION**

MIS-550

## WIRING – MAIN POWER

Refer to the unit rating plate for wire sizing information and maximum fuse or “HACR” type circuit breaker size. Each outdoor unit is marked with a “Minimum Circuit Ampacity”. This means that the field wiring used must be sized to carry that amount of current. Depending on the installed KW of electric heat, there may be two field power circuits required. If this is the case, the unit serial plate will so indicate. All models are suitable only for connection with copper wire. Each unit and/or wiring diagram will be marked “Use Copper Conductors Only”. These instructions **must be** adhered to. Refer to the National Electrical Code (NEC) for complete current carrying capacity data on the various insulation grades of wiring material. All wiring must conform to NEC and all local codes.

The electrical data lists fuse and wire sizes (75° C copper) for all models including the most commonly used heater sizes. Also shown are the number of field power circuits required for the various models with heaters.

The unit rating plate lists a “Maximum Time Delay Relay Fuse” or “HACR” type circuit breaker that is to be used with the equipment. The correct size must be used for proper circuit protection and also to assure that there will be no nuisance tripping due to the momentary high starting current of the compressor motor.

The disconnect access door on this unit may be locked to prevent unauthorized access to the disconnect. To convert for the locking capability, bend the tab locate in the bottom left hand corner of the disconnect opening under the disconnect access panel straight out. This tab will now line up with the slot in the door. When shut a padlock may be placed through the hole in the tab preventing entry.

See “Start Up” section for important information on three phase scroll compressor start ups.

## WIRING – LOW VOLTAGE WIRING

230 / 208V, 1 phase and 3 phase equipment dual primary voltage transformers. All equipment leaves the factory wired on 240V tap. For 208V operation, reconnect from 240V to 208V tap. The acceptable operating voltage range for the 240 and 208V taps are:

TAP	RANGE
240	253 – 216
208	220 – 187

*NOTE: The voltage should be measured at the field power connection point in the unit and while the unit is operating at full load (maximum amperage operating condition).*

Five (5) wires should be run from thermostat subbase to the 24V terminal board in the unit. A five conductor, 18 gauge copper, color-coded thermostat cable is recommended. The connection points are shown in Figure 7:

**TABLE 3  
THERMOSTAT WIRE SIZE**

Transformer VA	FLA	Wire Gauge	In Feet
55	2.3	20 gauge	45
		18 gauge	60
		16 gauge	100
		14 gauge	160
		12 gauge	250

**TABLE 4  
WALL THERMOSTAT AND SUBBASE COMBINATIONS**

Thermostat	Subbase	Predominate Features
8403-002 T87F3111	8404-003 Q539A1220	1 stage heat, 1 stage cool System: heat-off-cool Fan: auto-on
8403-041 T8034C	---	1 stage heat, 1 stage cool System: heat-off-cool Fan: auto-on
8403-019 T874C1760	8404-012 Q674A1001	1 stage cool, 2 stage heat System: heat-auto-cool Fan: auto-on
8403-021 T874D1934	8404-012 Q674A1001	2 stage cool, 2 stage heat System: heat-auto-cool Fan: auto-on
8403-035 1F95-80	---	2 stage cool, 2 stage heat Electronic 7 day programming
8403-043 CM-200	---	1 stage heat, 1 stage cool System: heat-off-cool Fan: auto-on

**FIGURE 7  
UNIT 24V TERMINAL BOARD**

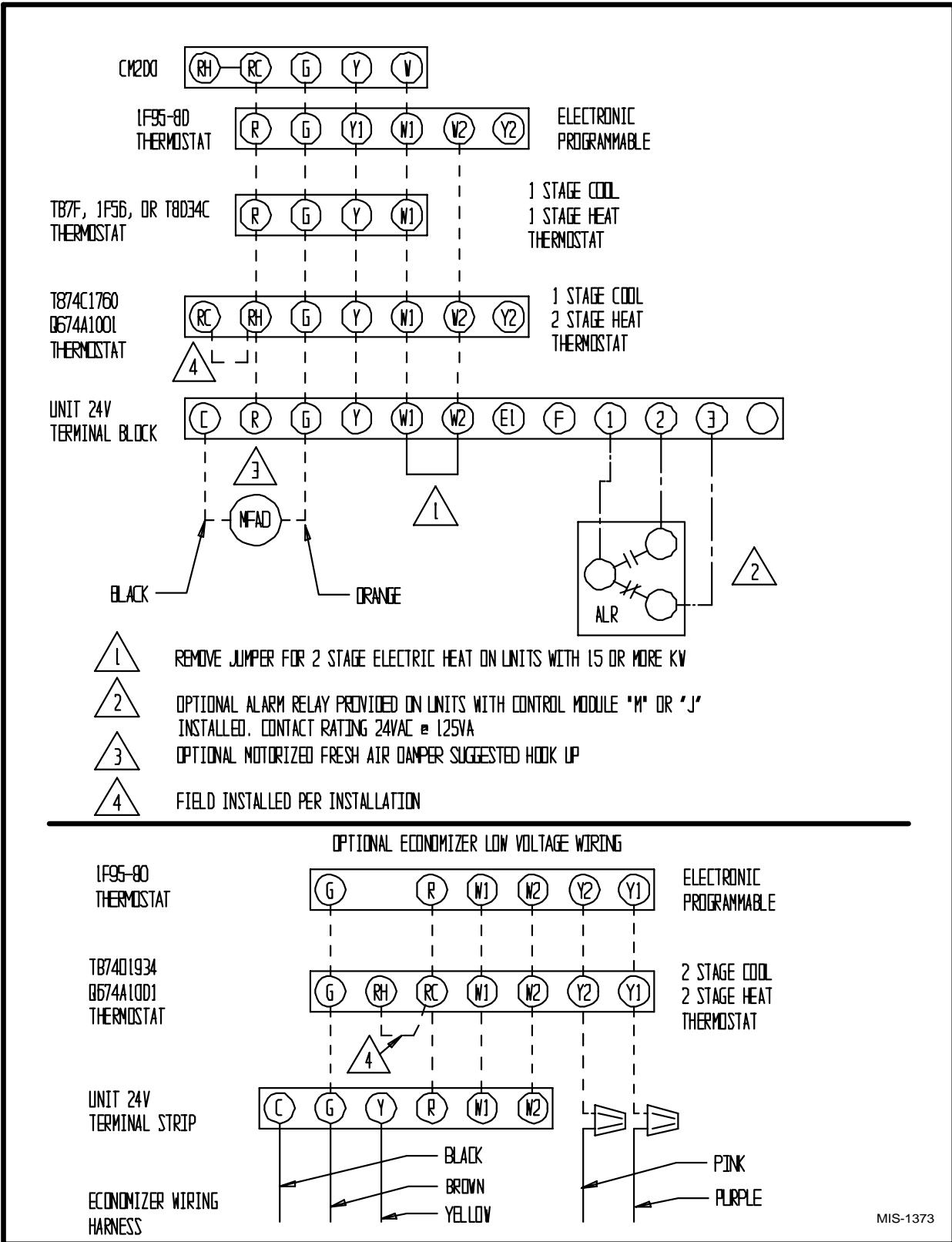

MIS-1373

## IMPORTANT INSTALLER NOTE

For improved start up performance wash the indoor coil with a dish washing detergent.

## CRANKCASE HEATERS

These units are not provided with crankcase heat. These units utilize scroll compressors which do not require crankcase heat in this application.

## HIGH PRESSURE SWITCH

The models are supplied with a remote reset high pressure switch. If tripped, this pressure switch may be reset by turning the thermostat off then back on again.

## THREE PHASE SCROLL COMPRESSOR START UP INFORMATION

Scroll compressors, like several other types of compressors, will only compress in one rotational direction. Direction of rotation is not an issue with single phase compressors since they will always start and run in the proper direction.

However, three phase compressors will rotate in either direction depending upon phasing of the power. Since there is a 50-50 chance of connecting power in such a way as to cause rotation in the reverse direction, verification of proper rotation must be made.

Verification of proper rotation direction is made by observing that suction pressure drops and discharge pressure rises when the compressor is energized.

Reverse rotation also results in an elevated sound level over that with correct rotation, as well as, substantially reduced current draw compared to tabulated values.

Verification of **proper rotation** must be made at the time the equipment is put into service. If improper rotation is corrected at this time there will be no negative impact on the durability of the compressor. However, reverse operation for over one hour may have a negative impact on the bearing due to oil pump out.

*NOTE: If compressor is allowed to run in reverse rotation for several minutes, the compressor's internal protector will trip.*

All three phase ZR3 compressors are wired identically internally. As a result, once the correct phasing is determined for a specific system or installation, connecting properly phased power leads to the same Fusite terminal should maintain proper rotation direction.

The direction of rotation of the compressor may be changed by reversing any two line connections to the unit.

## SERVICE HINTS

1. Caution homeowner to maintain clean air filters at all times. Also, not to needlessly close off supply and return air registers. This reduces air flow through the system, which shortens equipment service life as well as increasing operating costs.
2. Switching to heating cycle at 75° F or higher outside temperature may cause a nuisance trip of the remote reset high pressure switch. Turn thermostat off then on to reset the high pressure switch.
3. Check all power fuses or circuit breakers to be sure they are the correct rating.
4. Periodic cleaning of the outdoor coil to permit full and unrestricted airflow circulation is essential.

## SEQUENCE OF OPERATION

**COOLING** – Circuit R-Y makes at thermostat pulling in compressor contactor, starting the compressor and outdoor motor. The G (indoor motor) circuit is automatically completed on any call for cooling operation or can be energized by manual fan switch on subbase of constant air circulation. On all 230 volt units there is a one minute off delay on the blower motor. 460 volt models do not have an off delay.

## COMPRESSOR CONTROL MODULE

The compressor control module is standard on the models covered by this manual. The compressor control is an anti-short cycle/lockout timer with high and low pressure switch monitoring and alarm relay output.

### Adjustable Delay On Make And Break Timer

On initial power up or any time power is interrupted to the unit the *delay on make* period begins which will be 2 minutes plus 10% of the *delay on break* setting. When the delay on make is complete and the high pressure switch (and low pressure switch if employed) is closed, the compressor contactor is energized. Upon shutdown the delay or break timer starts and prevents restart until the delay on break and delay on make periods have expired.

During routine operation of the unit with no power interruptions the compressor will operate on demand with no delay.

## High Pressure Switch and Lockout Sequence

If the high pressure switch opens, the compressor contactor will de-energize immediately. The lockout timer will go into a *soft lockout* and stay in soft lockout until the high pressure switch closes and the delay on break time has expired. If the high pressure switch opens again in this same operating cycle the unit will go into *manual lockout* condition and the alarm relay circuit will energize. Recycling the wall thermostat resets the manual lockout.

## Low Pressure Switch, Bypass, and Lockout Sequence

If the low pressure switch opens for more than 120 seconds, the compressor contactor will de-energize and go into a soft lockout. Regardless the state of the low pressure switch, the contactor will reenergize after the delay on make time delay has expired. If the low pressure switch remains open, or opens again for longer than 120 seconds the unit will go into manual lockout condition and the alarm relay circuit will energize. Recycling the wall thermostat resets the manual lockout.

## Alarm Relay Output

Alarm terminal is output connection for applications where alarm relay is employed. This terminal is powered whenever compressor is locked out due to HPC or LPC sequences as described.

*NOTE: Both high and low pressure switch controls are inherently automatic reset devices. The high pressure switch and low pressure switch cut out and cut in settings are fixed by specific air conditioner or heat pump unit model. The lockout features, both soft and manual, are a function of the Compressor Control Module.*

## ADJUSTMENTS

### Adjustable Delay on Make and Delay on Break Timer

The potentiometer is used to select Delay on Break time from 30 seconds to 5 minutes. Delay on Make (DOM) timing on power-up and after power interruptions is equal to 2 minutes plus 10% of Delay on Break (DOB) setting:

0.5 minute (30 seconds)	DOB = 123 second	DOM
1.0 minute (60 seconds)	DOB = 126 second	DOM
2.0 minute (120 seconds)	DOB = 132 second	DOM
3.0 minute (180 seconds)	DOB = 138 second	DOM
4.0 minute (240 seconds)	DOB = 144 second	DOM
5.0 minute (300 seconds)	DOB = 150 second	DOM

During routine operation of the unit with no power interruptions the compressor will operate on demand with no delay.

### Typical Settings for Dual Unit Installation:

Unit No. 1: DOB set at 2 minutes, and DOM is 132 seconds

Unit No. 2: DOB set at 4 minutes, and DOM is 144 seconds

## PHASE MONITOR

All units with three phase scroll compressors are equipped with a 3 phase line monitor to prevent compressor damage due to phase reversal.

The phase monitor in this unit is equipped with two LEDs. If the Y signal is present at the phase monitor and phases are correct the green LED will light.

If phases are reversed, the red fault LED will be lit and compressor operation is inhibited.

If a fault condition occurs, reverse two of the supply leads to the unit. Do not reverse any of the unit factory wires as damage may occur.

## PRESSURE SERVICE PORTS

High and low pressure service ports are installed on all units so that the system operating pressures can be observed. A pressure table can be found later in the manual covering all models. It is imperative to match the correct pressure table to the unit by model number.



# TROUBLESHOOTING

## FAN BLADE SETTING DIMENSIONS

Shown in Figure 10 is the correct fan blade setting dimension for proper air delivery across the outdoor coil.

Any service work requiring removal or adjustment in the fan and/or motor area will require that the dimensions below be checked and blade adjusted in or out on the motor shaft accordingly.

**FIGURE 8**

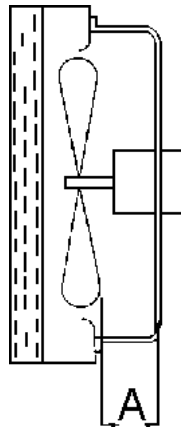

**TABLE 5**

Model	Dimension A
WA7013	1.25

## REMOVAL OF FAN SHROUD

1. Disconnect all power to the unit.
2. Remove the screws holding both grilles, one on each side of unit, and remove grilles.
3. Remove screws holding fan shroud to condenser and bottom. Nine (9) screws.
4. Unwire condenser fan motor.

**TABLE 6**  
**INDOOR BLOWER PERFORMANCE**  
**CFM @ 230V**

E.S.P. In H <sub>2</sub> O	WA7013	
	High Speed	
	Dry Coil	Wet Coil
.0	1775	1600
.1	1675	1525
.2	1575	1425

5. Slide complete motor, fan blade, and shroud assembly out the left side of the unit.
6. Service motor/fan as needed.
7. Reverse steps to reinstall.

## REFRIGERANT CHARGE

The correct system R-22 charge is shown on the unit rating plate. Optimum unit performance will occur with a refrigerant charge resulting in a suction line temperature (6" from compressor) as shown in Table 7.

**TABLE 7**  
**REFRIGERANT CHARGE**

Model	Airflow	95 OD Temperature	82 OD Temperature
W701	1700	58 - 60	56 - 58

The suction line temperatures in table above are based upon 80° F dry bulb / 67° F wet bulb (50% R.H.) temperature and rated airflow across the evaporator during cooling cycle.

**TABLE 8**  
**RATED CFM AND ESP**

Model	Rated CFM	Rated ESP	Recommended Airflow Range
WA7013	1425	0.20	1775 - 1425 ①

- ① Rated CFM & ESP on High Speed tap with 14 x 28 return air filter grille

**TABLE 9**  
**MAXIMUM ESP OF OPERATION**  
**ELECTRIC HEAT ONLY**

MODELS		ESP
WA7013	A10	.3
	B09	.3

Values shown are for units equipped with standard 1" throwaway filters or 1" washable filters. Derate ESP by .15 for 2" pleated filters.

**TABLE 10  
PRESSURE TABLE**

**COOLING**

Air Temperature Entering Outdoor Coil °F

Model	Return Air Temperature	Pressure	75	80	85	90	95	100	105	110	115
WA7013A	75 deg. DB	Low Side	68	68	69	70	71	72	73	74	75
	62 deg. WB	High Side	215	228	242	256	272	289	305	324	343
	80 deg. DB	Low Side	73	73	74	75	76	77	78	79	80
WA7013B	67 deg. WB	High Side	220	234	248	263	279	296	313	332	352
	85 deg. DB	Low Side	76	76	77	78	79	80	81	82	83
	72 deg. WB	High Side	228	242	257	272	289	306	324	344	364
WA7013B	75 deg. DB	Low Side	62	63	64	65	66	67	68	69	70
	62 deg. WB	High Side	214	230	247	265	280	299	316	333	351
	80 deg. DB	Low Side	67	68	69	70	71	72	73	73	75
WA7013B	67 deg. WB	High Side	220	236	254	271	287	306	306	324	360
	85 deg. DB	Low Side	72	73	74	75	76	77	78	79	80
	72 deg. WB	High Side	225	243	261	279	297	316	335	353	372

Low side pressure ± 2 PSIG  
High side pressure ± 5 PSIG

Tables are based upon rated CFM (airflow) across the evaporator coil. If there is any doubt as to correct operating charge being in the system, the charge should be removed, system evacuated and recharged to serial plate instructions.

**TABLE 11  
OPTIONAL ACCESSORIES**

Part Number	Description	WA7013A	WA7013B
CMC-15	Start Kit	X	
WMCB-09A	Circuit Breaker Kit	X	
WMCB-07B	Circuit Breaker Kit		X