INSTALLATION INSTRUCTIONS

WALL MOUNTED PACKAGE AIR CONDITIONERS

MODELS
WL4842
WL4843
WL6022
WL6023
WL602N



Bard Manufacturing Company, Inc.
Bryan, Ohio 43506
Since 1914...Moving ahead just as planned.

Manual : 2100-402A
Supersedes: 2100-402
File: Volume III Tab 16
Date: 07-25-06

Contents

Getting Other Information and Publications 3

Wall Mount General Information

Air Conditioning Wall Mount Model Nomenclature	4
Shipping Damage	8
General	8
Duct Work	8
Condensate Drain	8
Filters	8

Installation Instructions

Wall Mounting Information	9
Mounting the Unit	9
Wiring – Main Power	15
Wiring – Low Voltage Wiring	15

Figures

Figure 1 Unit Dimensions	5
WA602N, WA6023, WA4843	
Figure 2 Unit Dimensions	6
WA6022, WA4842	
Figure 3 Mounting Instructions	10
WA602N, WA6023, WA4843	
Figure 4 Mounting Instructions	11
WA6022, WA4842	
Figure 5 Electric Heat Clearance	12
Figure 6 Wall Mounting Instructions	13
Figure 7 Wall Mounting Instructions	13
Figure 8 Common Wall Mounting Installations	14
Figure 9 Unit 24V Terminal Board	16
Figure 10 Fan Blade Setting	19

Start Up

Important Installer Note	17
Crankcase Heaters	17
High Pressure Switch	17
Three Phase Scroll Compressor Start Up	17
Phase Monitor	17
Service Hints	17
Sequence of Operation	17
Compressor Control Module	17
Adjustments	18
Pressure Service Ports	18

Troubleshooting

Fan Blade Setting Dimensions	19
Removal of Fan Shroud	19
Refrigerant Charge	19
Pressure Table	18
Optional Accessories	19

Tables

Table 1 Electric Heat Table	4
Table 2 Electrical Specifications	7
Table 3 Thermostat Wire Size	15
Table 4 Wall Thermostat	15
Table 5 Fan Blade Dimensions	19
Table 6 Indoor Blower Performance	19
Table 7 Refrigerant Charge	19
Table 8 Rated CFM and Rated ESP	19
Table 9 Maximum ESP of Operation	
Electric Heat Only	20
Table 10 Pressure Table	20
Table 11 Optional Accessories	21

Getting Other Information and Publications

These publications can help you install the air conditioner or heat pump. You can usually find these at your local library or purchase them directly from the publisher. Be sure to consult current edition of each standard.

- National Electrical Code ANSI/NFPA 70

- Standard for the Installation ANSI/NFPA 90A
of Air Conditioning and Ventilating Systems

- Standard for Warm Air ANSI/NFPA 90B
Heating and Air Conditioning Systems

- Load Calculation for ACCA Manual J
Residential Winter and Summer Air Conditioning

- Duct Design for Residential ACCA Manual D
Winter and Summer Air Conditioning and Equipment
Selection

FOR MORE INFORMATION, CONTACT THESE PUBLISHERS:

ACCA **Air Conditioning Contractors of America**
1712 New Hampshire Ave. N.W.
Washington, DC 20009
Telephone: (202) 483-9370
Fax: (202) 234-4721

ANSI **American National Standards Institute**
11 West Street, 13th Floor
New York, NY 10036
Telephone: (212) 642-4900
Fax: (212) 302-1286

ASHRAE **American Society of Heating Refrigerating,
and Air Conditioning Engineers, Inc.**
1791 Tullie Circle, N.E.
Atlanta, GA 30329-2305
Telephone: (404) 636-8400
Fax: (404) 321-5478

NFPA **National Fire Protection Association**
Batterymarch Park
P.O. Box 9101
Quincy, MA 02269-9901
Telephone: (800) 344-3555
Fax: (617) 984-7057

WALL MOUNT GENERAL INFORMATION

AIR CONDITIONING WALL MOUNT MODEL NOMENCLATURE

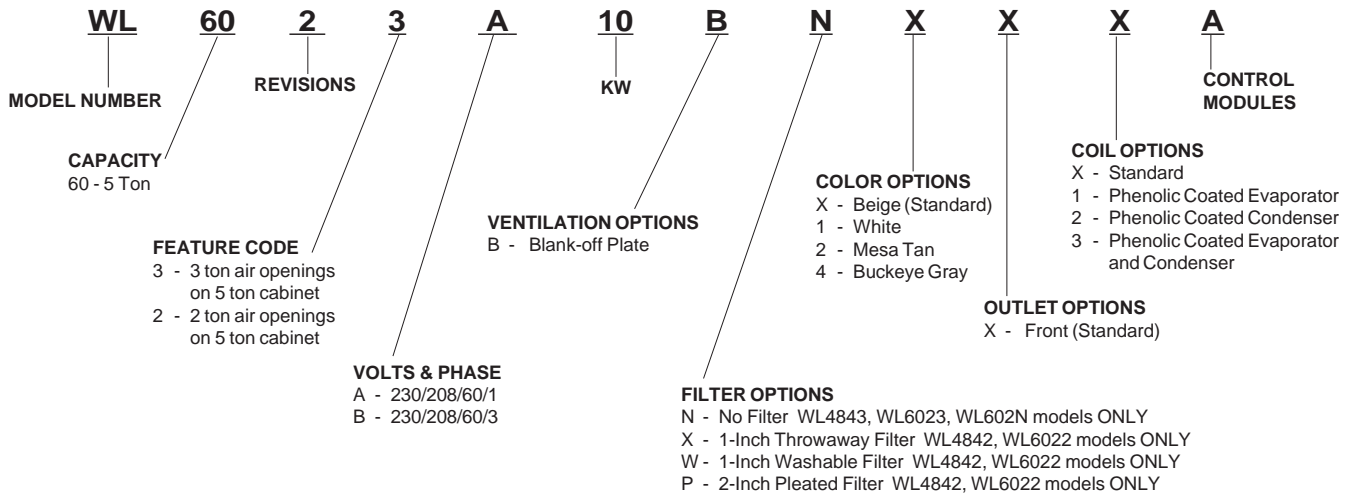

NOTE: All vent options are without exhaust capability. May require separate field supplied barometric relief in building.

Model WL602N is identical to Model WL6023.
All references in this manual to WL6023 apply to WL602N also.

**TABLE 1
ELECTRIC HEAT TABLE**

Models	WL6023A ONLY				WL6023B ONLY			
	240V-1		208V-1		240V-1		208V-1	
	AMPS	BTUH	AMPS	BTUH	AMPS	BTUH	AMPS	BTUH
5.0	20.8	17,050	18.1	12,800	---	---	---	---
9.0	---	---	---	---	21.7	30,600	18.7	23,030
10.0	41.6	34,130	36.2	25,600	---	---	---	---

**WL4842A, WL4842B, WL4843A, WL4843B, WL6022A, WL6022B
are not approved for use with electric heat.**

FIGURE 1
UNIT DIMENSIONS
WL602N, WL6023, WL4843 ONLY

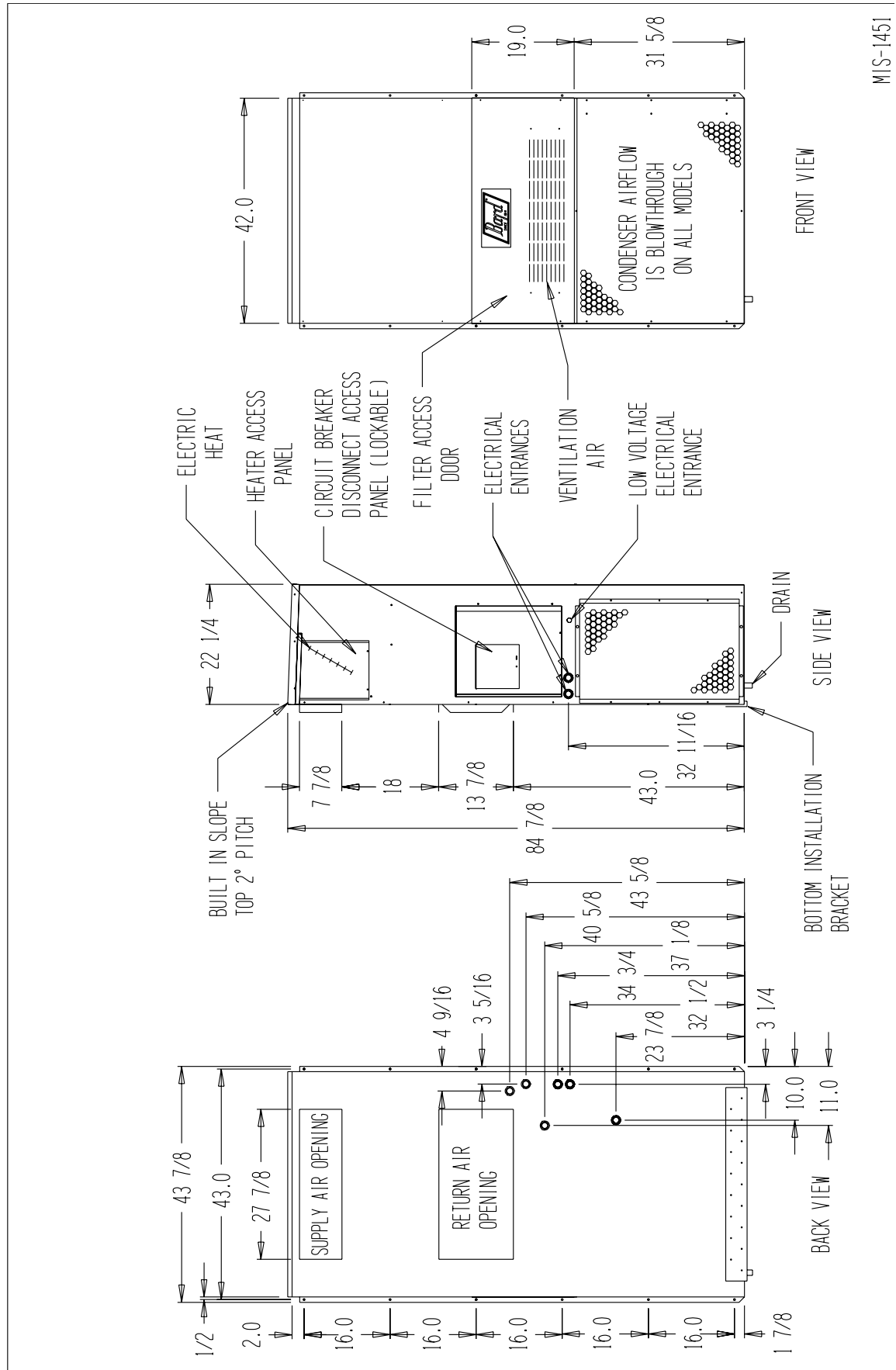

MIS-1451

FIGURE 2
UNIT DIMENSIONS
WL6022, WL4842 ONLY

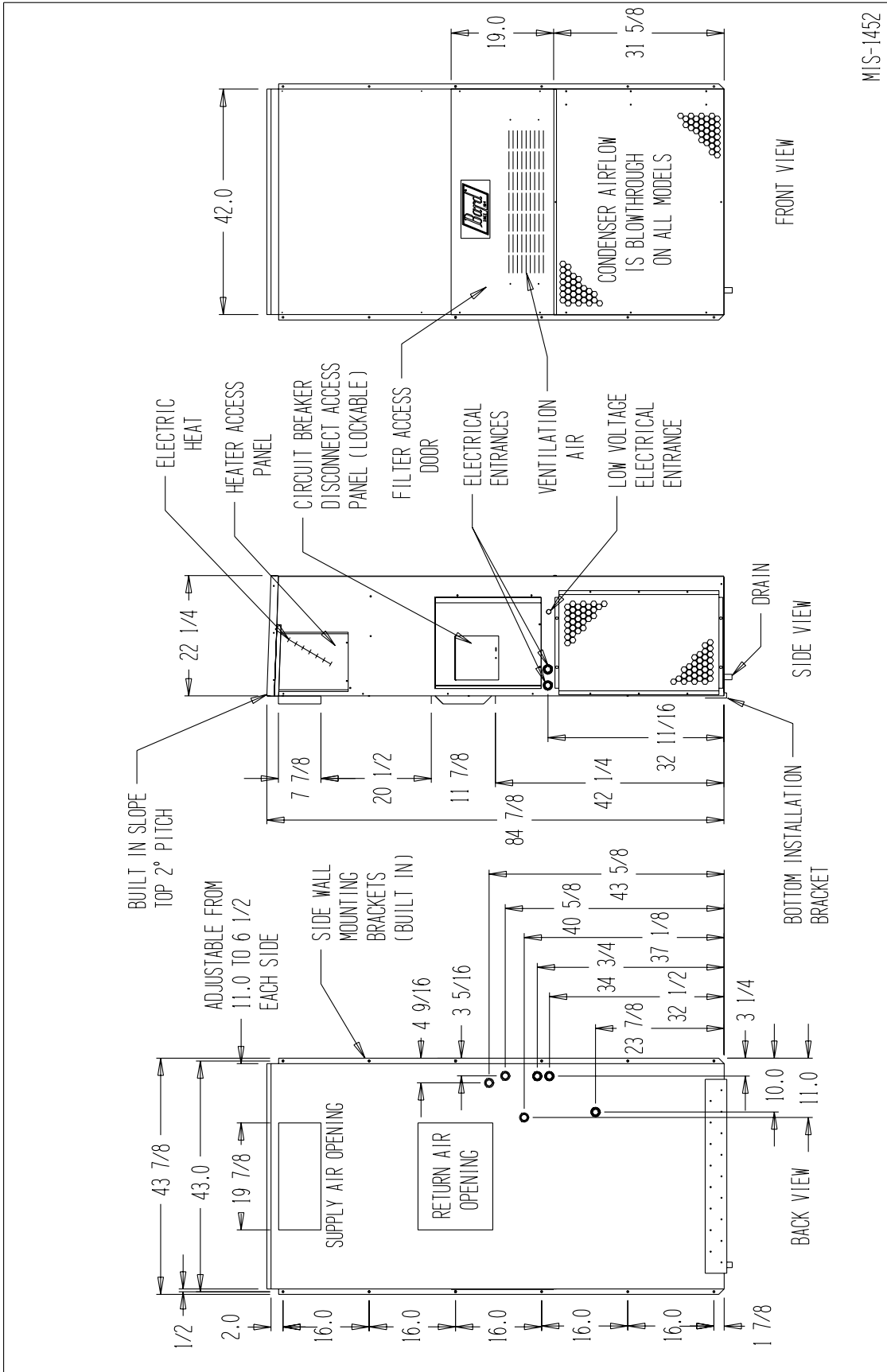

MIS-1452

**TABLE 2
ELECTRICAL SPECIFICATIONS**

Model	SINGLE CIRCUIT					DUAL CIRCUIT								
	Rated Volts & Phase	No. Field Power Circuits	③ Minimum Circuit Ampacity	① Maximum External Fuse or Ckt. Breaker	② Field Power Wire Size	② Ground Wire Size	③ Minimum Circuit Ampacity		① Maximum External Fuse or Ckt. Breaker		② Field Power Wire Size		② Ground Wire Size	
							CKT A	CKT B	CKT A	CKT B	CKT A	CKT B	CKT A	CKT B
WL4842A00, A0Z	230/208-1	1	36	50	8	10	N/A	N/A	N/A	N/A	N/A	N/A	N/A	N/A
WL4842B00, B0Z	230/208-3	1	25	35	8	10	N/A	N/A	N/A	N/A	N/A	N/A	N/A	N/A
WL4843A00, A0Z	230/208-1	1	36	50	8	10	N/A	N/A	N/A	N/A	N/A	N/A	N/A	N/A
WL4843B00, B0Z	230/208-3	1	25	35	8	10	N/A	N/A	N/A	N/A	N/A	N/A	N/A	N/A
WL6022A00, A0Z	230/208-1 A05 A10	1	44	60	8	10	N/A	N/A	N/A	N/A	N/A	N/A	N/A	N/A
WL6022A05, A05		1	44	60	8	10	N/A	N/A	N/A	N/A	N/A	N/A	N/A	N/A
WL6022A10, A10		1	55	60	6	10	N/A	N/A	N/A	N/A	N/A	N/A	N/A	N/A
WL6022B00, B0Z	230/208-3 B09	1	32	45	8	10	N/A	N/A	N/A	N/A	N/A	N/A	N/A	N/A
WL6022B09, B09		1	34	45	8	10	N/A	N/A	N/A	N/A	N/A	N/A	N/A	N/A
WL6023A00, A0Z	230/208-1 A05 A10	1	44	60	8	10	N/A	N/A	N/A	N/A	N/A	N/A	N/A	N/A
WL6023A05, A05		1	44	60	8	10	N/A	N/A	N/A	N/A	N/A	N/A	N/A	N/A
WL6023A10, A10		1	55	60	6	10	N/A	N/A	N/A	N/A	N/A	N/A	N/A	N/A
WL6023B00, B0Z	230/208-3 B09	1	32	45	8	10	N/A	N/A	N/A	N/A	N/A	N/A	N/A	N/A
WL6023B09, B09		1	34	45	8	10	N/A	N/A	N/A	N/A	N/A	N/A	N/A	N/A
WL602NA00, A0Z	230/208-1 A05 A10	1	44	60	8	10	N/A	N/A	N/A	N/A	N/A	N/A	N/A	N/A
WL602NA05, A05		1	44	60	8	10	N/A	N/A	N/A	N/A	N/A	N/A	N/A	N/A
WL602NA10, A10		1	55	60	6	10	N/A	N/A	N/A	N/A	N/A	N/A	N/A	N/A
WL602NB00, B0Z	230/208-3 B09	1	32	45	8	10	N/A	N/A	N/A	N/A	N/A	N/A	N/A	N/A
WL602NB09, B09		1	34	45	8	10	N/A	N/A	N/A	N/A	N/A	N/A	N/A	N/A

① Maximum size of the time delay fuse or HACR type circuit breaker for protection of field wiring conductors.

② Based on 75° C copper wire. All Wiring must conform to NEC and all local codes.

③ These "Minimum Circuit Ampacity" values are to be used for sizing the field power conductors. Refer to the National Electric Code (latest revision), article 310 for power conductor sizing.

CAUTION: When more than one field power conductor circuit is run through one conduit, the conductors must be derated. Pay special attention to Note 8 of Table 310 regarding Ampacity Adjustment Factors when more than 3 conductors are in a raceway.

SHIPPING DAMAGE

Upon receipt of equipment, the carton should be checked for external signs of shipping damage. If damage is found, the receiving party must contact the last carrier immediately, preferably in writing, requesting inspection by the carrier's agent.

GENERAL

The equipment covered in this manual is to be installed by trained, experienced service and installation technicians.

The refrigerant system is completely assembled and charged. All internal wiring is complete.

The unit is designed for use with or without duct work. Flanges are provided for attaching the supply and return ducts.

These instructions explain the recommended method to install the air cooled self-contained unit and the electrical wiring connections to the unit.

While these instructions are intended as a general recommended guide, they do not supersede any national and/or local codes in any way. Authorities having jurisdiction should be consulted before the installation is made. See Page 3 for information on codes and standards.

Size of unit for a proposed installation should be based on heat loss calculation made according to methods of Air Conditioning Contractors of America (ACCA). The air duct should be installed in accordance with the Standards of the National Fire Protection Association for the Installation of Air Conditioning and Ventilating Systems of Other Than Residence Type, NFPA No. 90A, and Residence Type Warm Air Heating and Air Conditioning Systems, NFPA No. 90B. Where local regulations are at a variance with instructions, installer should adhere to local codes.

DUCT WORK

All duct work, supply and return, must be properly sized for the design air flow requirement of the equipment. Air Conditioning Contractors of America (ACCA) is an excellent guide to proper sizing. All duct work or portions thereof not in the conditioned space should be properly insulated in order to both conserve energy and prevent condensation or moisture damage.

These instructions and any instructions packaged with any separate equipment, required to make up the entire air conditioning system should be carefully read before beginning the installation. Note particularly any tags and/or labels attached to the equipment.

Design the duct work according to methods given by the Air Conditioning Contractors of America (ACCA). When duct runs through unheated spaces, it should be insulated with a minimum of one inch of insulation. Use insulation with a vapor barrier on the outside of the insulation. Flexible joints should be used to connect the duct work to the equipment in order to keep the noise transmission to a minimum.

A 1/4 inch clearance to combustible material for the first three feet of duct attached to the outlet air frame is required. See Wall Mounting Instructions and Figures 3 and 4 for further details.

Ducts through the walls must be insulated and all joints taped or sealed to prevent air or moisture entering the wall cavity.

Some installations may not require any return air duct. A metallic return air grille is required with installations not requiring a return air duct. The spacing between louvers on the grille shall not be larger than 5/8 inch.

NOTE: If no return air duct is used, applicable installation codes may limit this cabinet to installation only in a single story structure.

Any grille that meets with 5/8 inch louver criteria may be used. It is recommended that Bard Return Air Grille Kit RG2 through RG5 or RFG2 through RFG5 be installed when no return duct is used. Contact distributor or factory for ordering information. If using a return air filter grille, filters must be of sufficient size to allow a maximum velocity of 400 fpm.

CONDENSATE DRAIN

A plastic drain hose extends from the drain pan at the top of the unit down to the unit base. There are openings in the unit base for the drain hose to pass through. In the event the drain hose is connected to a drain system of some type, it must be an open or vented type system to assure proper drainage.

FILTERS

WL6022 AND WL4842 ONLY

A 1-inch throw away filter is supplied with each unit. The filter slides into position making it easy to service. This filter can be serviced from the outside by removing the service door. A 1-inch washable filter and a 2-inch pleated filter are also available as optional accessories. The internal filter brackets are adjustable to accommodate the 2-inch filter by bending the metal tabs holding the 1-inch filter down. There are two tabs on each side of the filter.

NOTE: WL6023 and WL4843 models require the use of a return air filter grille.

INSTALLATION INSTRUCTIONS

WALL MOUNTING INFORMATION

1. Two holes for the supply and return air openings must be cut through the wall as shown in Figure 1 or 2. Figure 1 is for models WL4843, and WL6023. Figure 2 is for Models WL4842 and WL6022.
2. On wood frame walls, the wall construction must be strong and rigid enough to carry the weight of the unit without transmitting any unit vibration.

WARNING

Fire hazard can result if 1/4 inch clearance to combustible materials for supply air duct is not maintained. See Figure 3.

3. Concrete block walls must be thoroughly inspected to insure that they are capable of carrying the weight of the installed unit.

WL4842 AND WL6022 ONLY

These units are equipped with adjustable return and supply air flanges. The flanges are adjustable side to side in 1" increments. This allows these units to be adjusted so that in side-by-side applications these units can replace two 2 Ton units using the same wall openings.

MOUNTING THE UNIT

1. These units are secured by wall mounting brackets which secure the unit to the outside wall surface at both sides. A bottom mounting bracket is provided for ease of installation, but is not required.
2. The unit itself is suitable for 0 inch clearance, but the supply air duct flange and the first 3 feet of supply air duct require a minimum of 1/4 inch clearance to combustible material. If a combustible wall use a minimum of 30½" x 10½" dimensions for sizing. However, it is generally recommended that a 1-inch clearance is used for ease of installation and maintaining the required clearance to combustible material. The supply air opening would then be 32" x 12". See Figures 2 and 3 for details.

WARNING

Failure to provide the 1/4 inch clearance between the supply duct and a combustible surface for the first 3 feet of duct can result in fire causing damage, injury or death.

3. Locate and mark lag bolt locations and bottom mounting bracket location. See Figure 2.
4. Mount bottom mounting bracket.
5. Hook top rain flashing under back bend of top. Top rain flashing is shipped secured to the right side of the back.
6. Position unit in opening and secure with 5/16 lag bolts; use 7/8 inch diameter flat washers on the lag bolts.
7. Secure rain flashing to wall and caulk across entire length of top. See Figure 2.
8. For additional mounting rigidity, the return air and supply air frames or collars can be drilled and screwed or welded to the structural wall itself (depending upon wall construction). Be sure to observe required clearance if combustible wall.
9. On side-by-side installations, maintain a minimum of 20 inches clearance on left side to allow access to control panel and heat strips, and to allow proper airflow to the outdoor coil. Additional clearance may be required to meet local or national codes.

FIGURE 3
MOUNTING INSTRUCTIONS
WL602N, WL6023, WL4843 ONLY

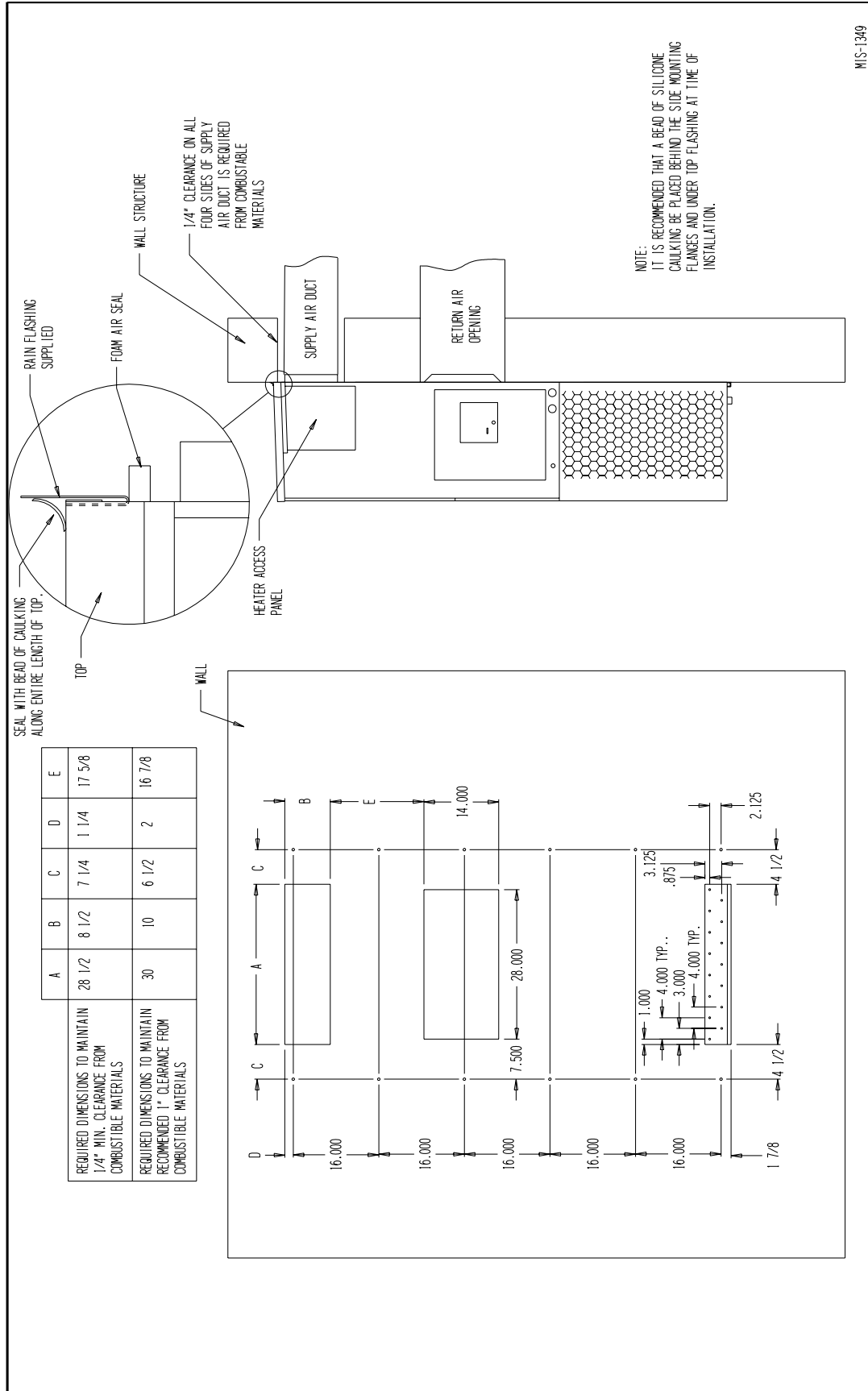
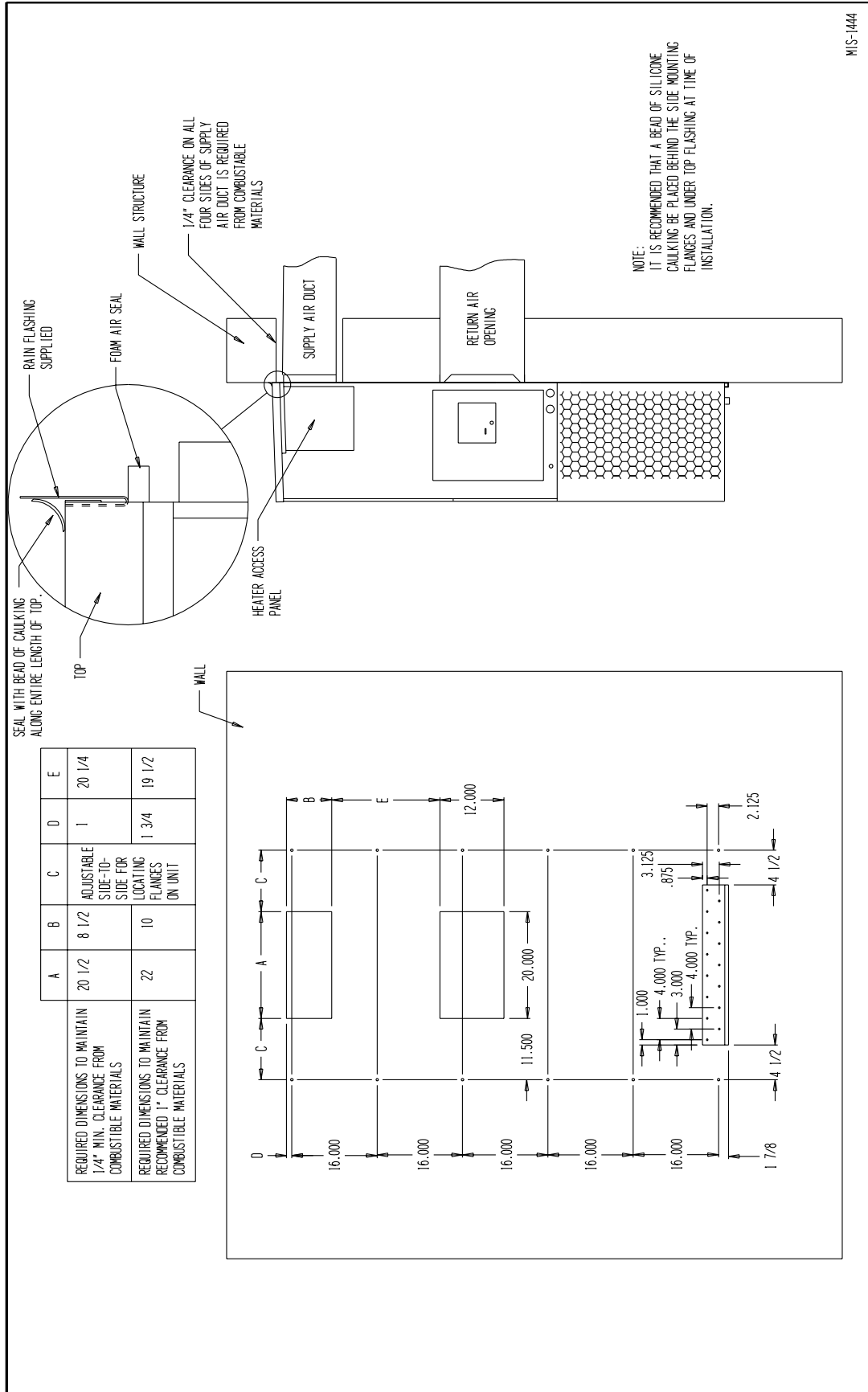

FIGURE 4
MOUNTING INSTRUCTIONS
WL6022, WL4842 ONLY



	A	B	C	D	E
REQUIRED DIMENSIONS TO MAINTAIN 1/4" MIN. CLEARANCE FROM COMBUSTIBLE MATERIALS	20 1/2	8 1/2	ADJUSTABLE SIDE-TO-SIDE FOR LOCATING FLANGES ON UNIT	1	20 1/4
REQUIRED DIMENSIONS TO MAINTAIN RECOMMENDED 1" CLEARANCE FROM COMBUSTIBLE MATERIALS	22	10		1 3/4	19 1/2

NOTE:
 IT IS RECOMMENDED THAT A BEAD OF SILICONE CAULKING BE PLACED BEHIND THE SIDE MOUNTING FLANGES AND UNDER TOP FLASHING AT TIME OF INSTALLATION.

MIS-1444

FIGURE 5
ELECTRIC HEAT CLEARANCE

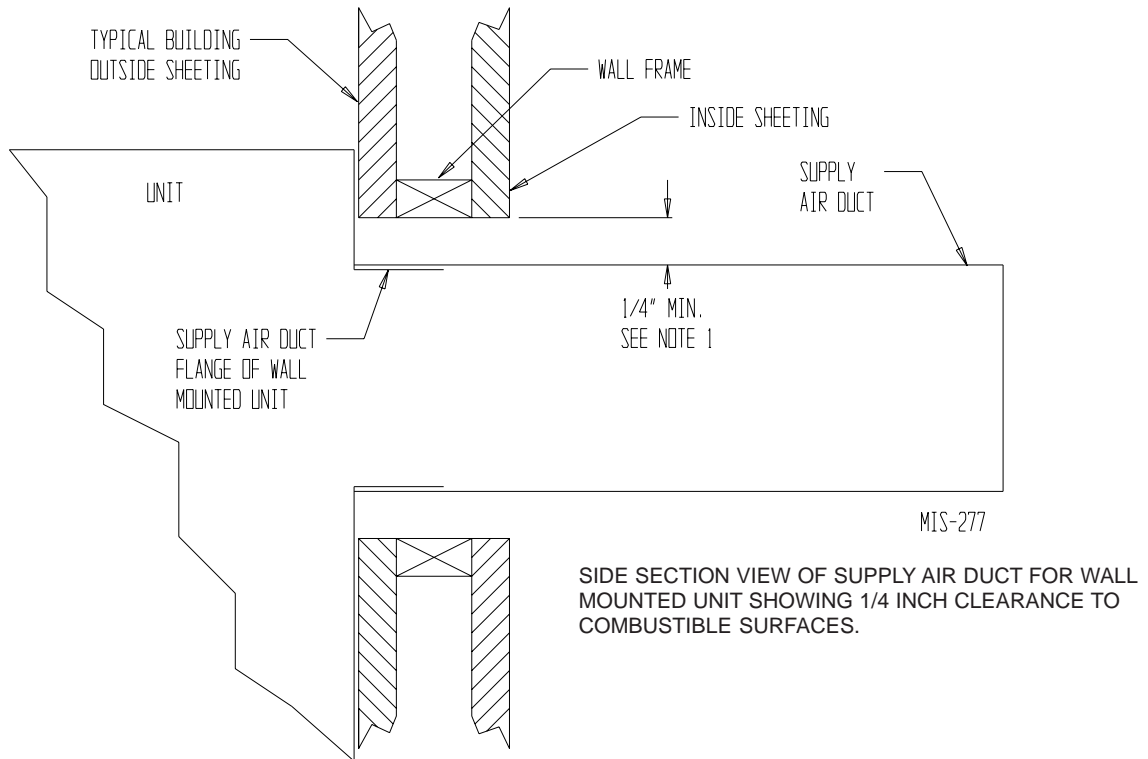

⚠ WARNING

A **minimum** of 1/4 inch clearance must be maintained between the supply air duct and combustible materials. This is required for the first 3 feet of ducting.

It is important to insure that the 1/4 inch minimum spacing is maintained at all points.

Failure to do this could result in overheating the combustible material and may result in a fire causing damage, injury or death.

**FIGURE 6
WALL MOUNTING INSTRUCTIONS**

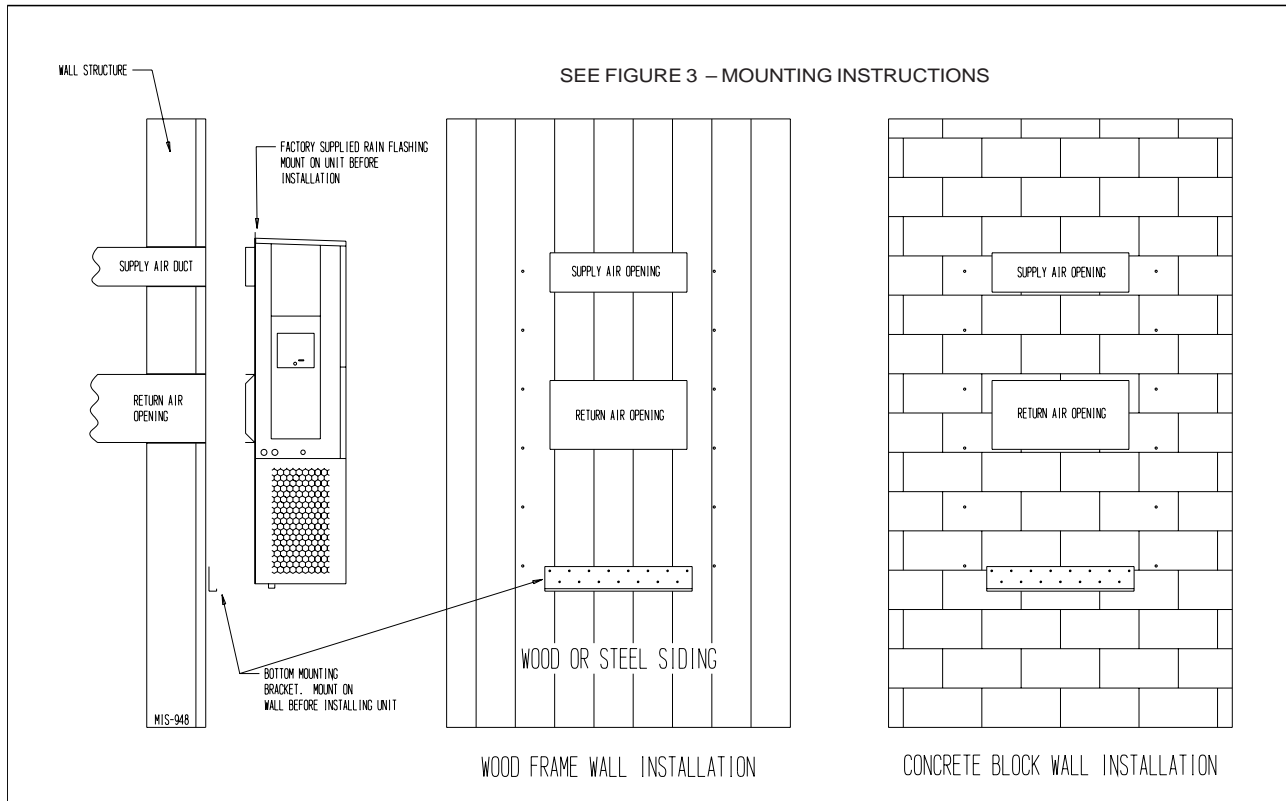

**FIGURE 7
WALL MOUNTING INSTRUCTIONS**

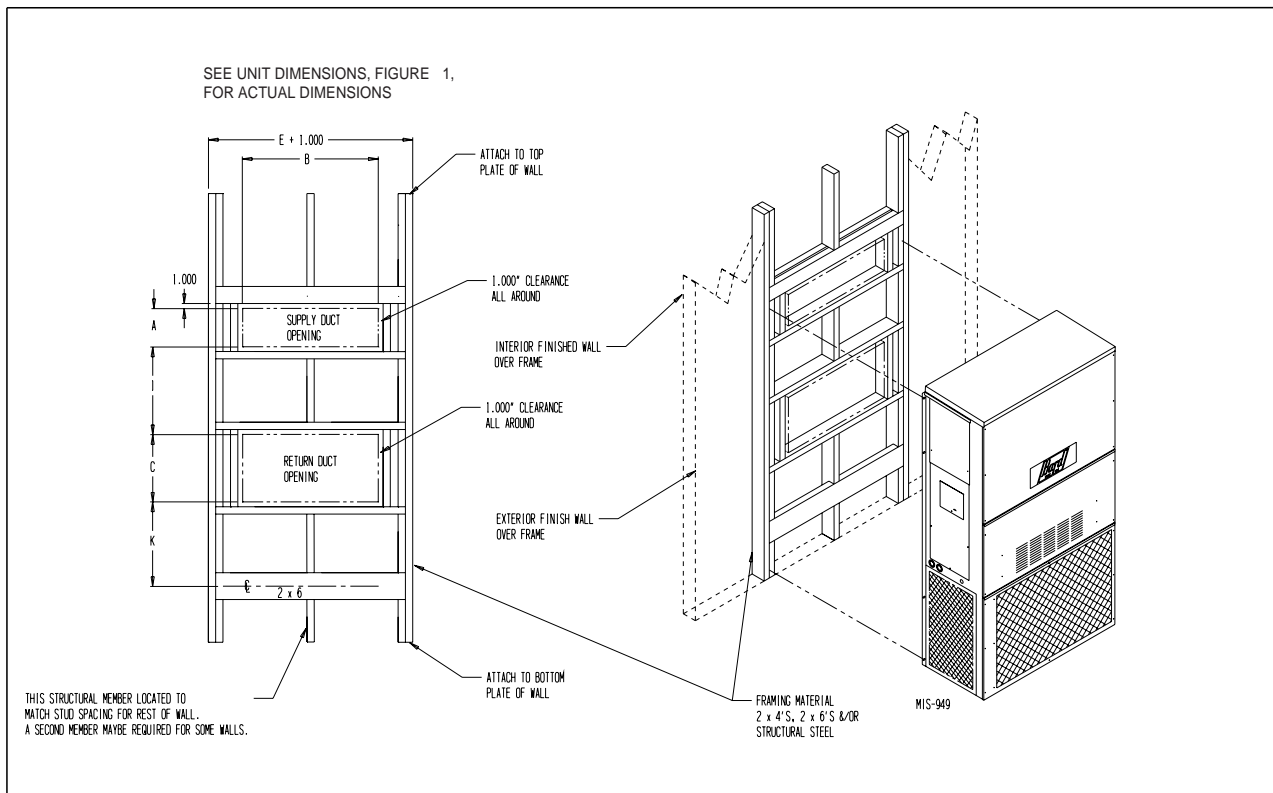

**FIGURE 8
COMMON WALL MOUNTING INSTALLATIONS**

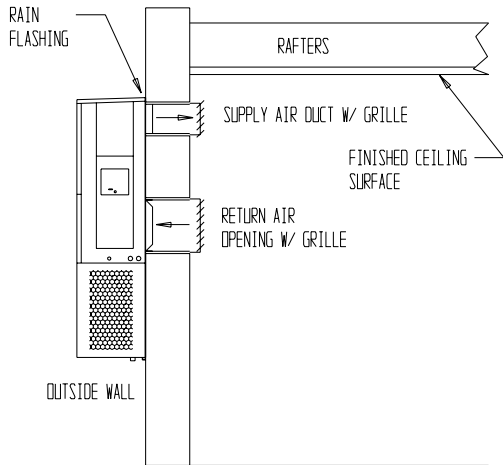

FREE AIR FLOW
NO DUCT

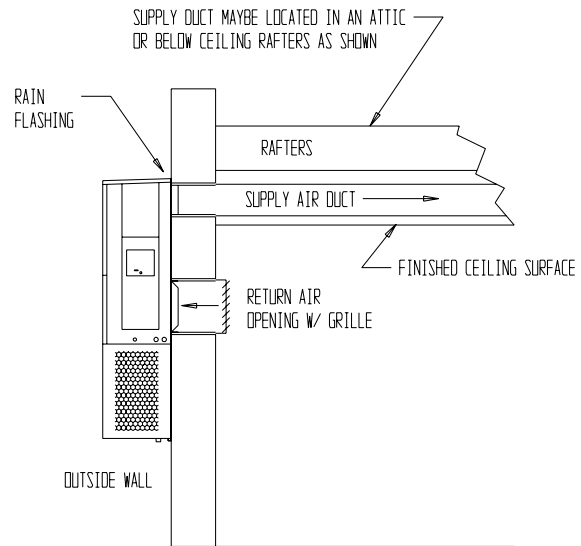

DUCTED SUPPLY
RETURN AT UNIT

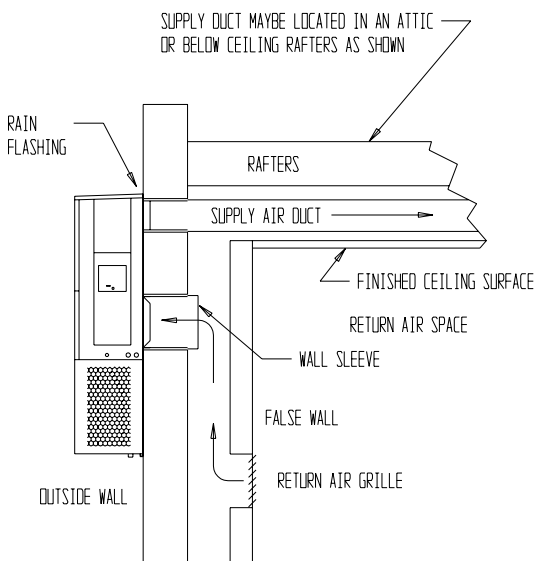

FALSE WALL INSTALLATION

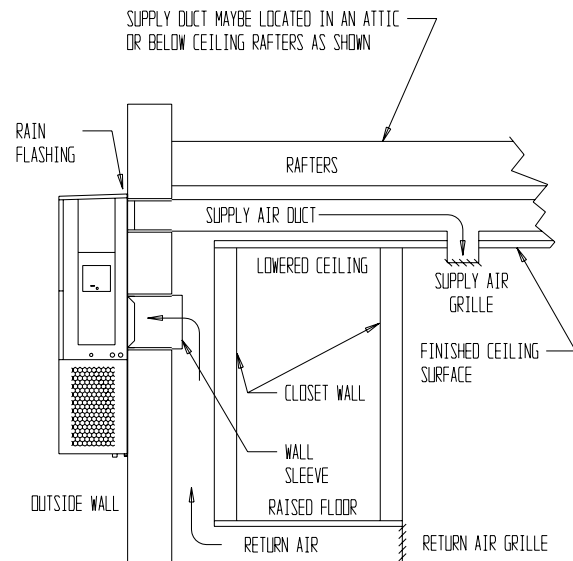

CLOSET INSTALLATION

MIS-550

WIRING – MAIN POWER

Refer to the unit rating plate for wire sizing information and maximum fuse or “HACR” type circuit breaker size. Each outdoor unit is marked with a “Minimum Circuit Ampacity”. This means that the field wiring used must be sized to carry that amount of current. Depending on the installed KW of electric heat, there may be two field power circuits required. If this is the case, the unit serial plate will so indicate. All models are suitable only for connection with copper wire. Each unit and/or wiring diagram will be marked “Use Copper Conductors Only”. These instructions *must be* adhered to. Refer to the National Electrical Code (NEC) for complete current carrying capacity data on the various insulation grades of wiring material. All wiring must conform to NEC and all local codes.

The electrical data lists fuse and wire sizes (75° C copper) for all models including the most commonly used heater sizes. Also shown are the number of field power circuits required for the various models with heaters.

The unit rating plate lists a “Maximum Time Delay Relay Fuse” or “HACR” type circuit breaker that is to be used with the equipment. The correct size must be used for proper circuit protection and also to assure that there will be no nuisance tripping due to the momentary high starting current of the compressor motor.

The disconnect access door on this unit may be locked to prevent unauthorized access to the disconnect. To convert for the locking capability, bend the tab locate in the bottom left hand corner of the disconnect opening under the disconnect access panel straight out. This tab will now line up with the slot in the door. When shut, a padlock may be placed through the hole in the tab preventing entry.

See “Start Up” section for important information on three phase scroll compressor start ups.

WIRING – LOW VOLTAGE WIRING

230 / 208V, 1 phase and 3 phase equipment dual primary voltage transformers. All equipment leaves the factory wired on 240V tap. For 208V operation, reconnect from 240V to 208V tap. The acceptable operating voltage range for the 240 and 208V taps are:

TAP	RANGE
240	253 – 216
208	220 – 187

NOTE: The voltage should be measured at the field power connection point in the unit and while the unit is operating at full load (maximum amperage operating condition).

Five (5) wires should be run from thermostat subbase to the 24V terminal board in the unit. A five conductor, 18 gauge copper, color-coded thermostat cable is recommended. The connection points are shown in Figure 9.

**TABLE 3
THERMOSTAT WIRE SIZE**

Transformer VA	FLA	Wire Gauge	Maximum Distance In Feet
55	2.3	20 gauge	45
		18 gauge	60
		16 gauge	100
		14 gauge	160
		12 gauge	250

**TABLE 4
WALL THERMOSTAT**

Thermostat	Predominate Features
8403-057 (TH5220D1153)	1 stage Cool; 1 stage Heat Electronic Non-Programmable Auto or Manual changeover
8403-058 (TH5220D1151)	2 stage Cool; 2 stage Heat Electronic Non-Programmable Auto or Manual changeover
8403-049 (1F93-380)	2 stage Cool; 2 stage Heat Programmable Electronic Auto or Manual changeover

**FIGURE 9
UNIT 24V TERMINAL BOARD**

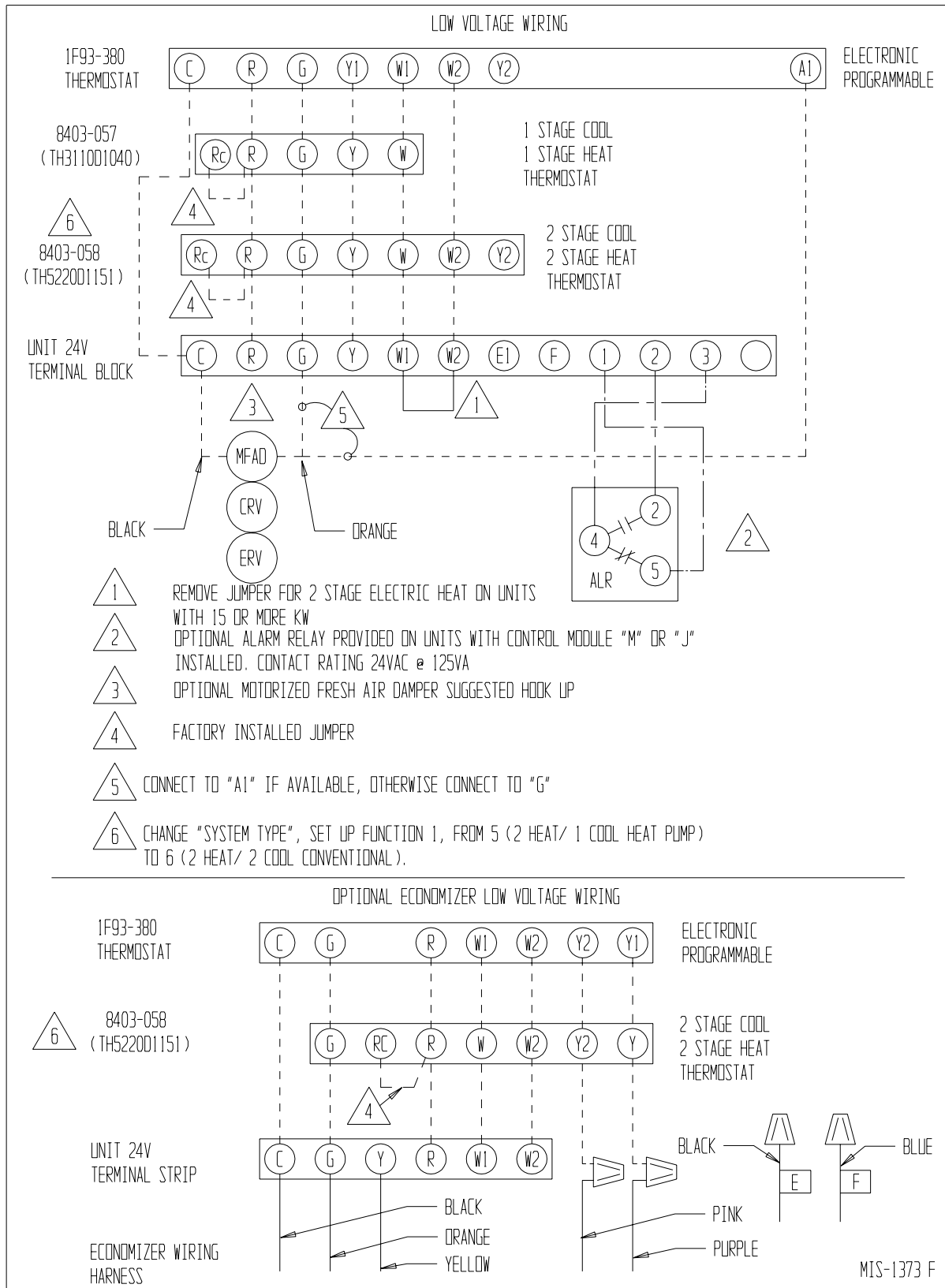

IMPORTANT INSTALLER NOTE

For improved start up performance wash the indoor coil with a dish washing detergent.

CRANKCASE HEATERS

These units are not provided with crankcase heat. These units utilize scroll compressors which do not require crankcase heat in this application.

HIGH PRESSURE SWITCH

The models are supplied with a remote reset high pressure switch. If tripped, this pressure switch may be reset by turning the thermostat off then back on again.

THREE PHASE SCROLL COMPRESSOR START UP INFORMATION

Scroll compressors, like several other types of compressors, will only compress in one rotational direction. Direction of rotation is not an issue with single phase compressors since they will always start and run in the proper direction.

However, three phase compressors will rotate in either direction depending upon phasing of the power. Since there is a 50-50 chance of connecting power in such a way as to cause rotation in the reverse direction, verification of proper rotation must be made. Verification of proper rotation direction is made by observing that suction pressure drops and discharge pressure rises when the compressor is energized. Reverse rotation also results in an elevated sound level over that with correct rotation, as well as, substantially reduced current draw compared to tabulated values.

Verification of **proper rotation** must be made at the time the equipment is put into service. If improper rotation is corrected at this time, there will be no negative impact on the durability of the compressor. However, reverse operation for over one hour may have a negative impact on the bearing due to oil pump out.

NOTE: If compressor is allowed to run in reverse rotation for several minutes, the compressor's internal protector will trip.

All three phase ZR3 compressors are wired identically internally. As a result, once the correct phasing is determined for a specific system or installation, connecting properly phased power leads to the same Fusite terminal should maintain proper rotation direction.

The direction of rotation of the compressor may be changed by reversing any two line connections to the unit.

PHASE MONITOR

All units with three phase scroll compressors are equipped with a 3 phase line monitor to prevent compressor damage due to phase reversal.

The phase monitor in this unit is equipped with two LEDs. If the Y signal is present at the phase monitor and phases are correct the green LED will light.

If phases are reversed, the red fault LED will be lit and compressor operation is inhibited.

If a fault condition occurs, reverse two of the supply leads to the unit. Do not reverse any of the unit factory wires as damage may occur.

SERVICE HINTS

1. Caution homeowner to maintain clean air filters at all times. Also, not to needlessly close off supply and return air registers. This reduces airflow through the system, which shortens equipment service life as well as increasing operating costs.
2. Switching to heating cycle at 75° F or higher outside temperature may cause a nuisance trip of the remote reset high pressure switch. Turn thermostat off, then on, to reset the high pressure switch.
3. Check all power fuses or circuit breakers to be sure they are the correct rating.
4. Periodic cleaning of the outdoor coil to permit full and unrestricted airflow circulation is essential.

SEQUENCE OF OPERATION

COOLING – Circuit R-Y makes at thermostat pulling in compressor contactor, starting the compressor and outdoor motor. The G (indoor motor) circuit is automatically completed on any call for cooling operation or can be energized by manual fan switch on subbase of constant air circulation. On all 230 volt units, there is a one-minute off delay on the blower motor. 460 volt models do not have an off delay.

COMPRESSOR CONTROL MODULE

The compressor control module is standard on the models covered by this manual. The compressor control is an anti-short cycle/lockout timer with high and low pressure switch monitoring and alarm relay output.

Adjustable Delay On Make and Break Timer

On initial power up or any time power is interrupted to the unit, the delay on make period begins, which will be 2 minutes plus 10% of the delay on break setting. When the delay on make is complete and the high pressure switch (and low pressure switch if employed) is closed, the compressor contactor is energized. Upon shutdown, the delay on break timer starts and prevents restart until the delay on break and delay on make periods have expired.

During routine operation of the unit with no power interruptions the compressor will operate on demand with no delay.

High Pressure Switch and Lockout Sequence

If the high pressure switch opens, the compressor contactor will de-energize immediately. The lockout timer will go into a *soft lockout* and stay in soft lockout until the high pressure switch closes and the delay on break time has expired. If the high pressure switch opens again in this same operating cycle, the unit will go into *manual lockout* condition and the alarm relay circuit will energize. Recycling the wall thermostat resets the manual lockout.

Low Pressure Switch, Bypass, and Lockout Sequence

If the low pressure switch opens for more than 120 seconds, the compressor contactor will de-energize and go into a soft lockout. Regardless the state of the low pressure switch, the contactor will reenergize after the delay on make time delay has expired. If the low pressure switch remains open, or opens again for longer than 120 seconds, the unit will go into manual lockout condition and the alarm relay circuit will energize. Recycling the wall thermostat resets the manual lockout.

Alarm Relay Output

Alarm terminal is output connection for applications where alarm relay is employed. This terminal is powered whenever compressor is locked out due to HPC or LPC sequences as described.

NOTE: Both high and low pressure switch controls are inherently automatic reset devices. The high pressure switch and low pressure switch cut out and cut in settings are fixed by specific air conditioner or heat pump unit model. The lockout features, both soft and manual, are a function of the Compressor Control Module.

ADJUSTMENTS

Adjustable Delay on Make and Delay on Break Timer

The potentiometer is used to select Delay on Break time from 30 seconds to 5 minutes. Delay on Make (DOM) timing on power-up and after power interruptions is equal to 2 minutes plus 10% of Delay on Break (DOB) setting:

0.5 minute (30 seconds)	DOB = 123 second	DOM
1.0 minute (60 seconds)	DOB = 126 second	DOM
2.0 minute (120 seconds)	DOB = 132 second	DOM
3.0 minute (180 seconds)	DOB = 138 second	DOM
4.0 minute (240 seconds)	DOB = 144 second	DOM
5.0 minute (300 seconds)	DOB = 150 second	DOM

During routine operation of the unit with no power interruptions the compressor will operate on demand with no delay.

Typical Settings for Dual Unit Installation:

Unit 1: DOB set at 2 minutes, and DOM is 132 seconds.

Unit 2: DOB set at 4 minutes, and DOM is 144 seconds

PRESSURE SERVICE PORTS

High and low pressure service ports are installed on all units so that the system operating pressures can be observed. A pressure table can be found later in the manual covering all models. It is imperative to match the correct pressure table to the unit by model number.

TROUBLESHOOTING

FAN BLADE SETTING DIMENSIONS

Shown in Figure 10 is the correct fan blade setting dimension for proper air delivery across the outdoor coil.

Any service work requiring removal or adjustment in the fan and/or motor area will require that the dimensions below be checked and blade adjusted in or out on the motor shaft accordingly.

**FIGURE 10
FAN BLADE SETTING**

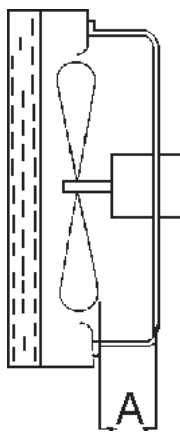

TABLE 5

Model	Dimension A
WL602N	1.75

REMOVAL OF FAN SHROUD

1. Disconnect all power to the unit.
2. Remove the screws holding both grilles, one on each side of unit, and remove grilles.
3. Remove screws holding fan shroud to condenser and bottom. Nine (9) screws.
4. Unwire condenser fan motor.
5. Slide complete motor, fan blade, and shroud assembly out the left side of the unit.
6. Service motor/fan as needed.
7. Reverse steps to reinstall.

**TABLE 6
INDOOR BLOWER PERFORMANCE
CFM @ 230V**

E.S.P. In H ₂ O	WL602N WL6023		WL6022		WL4843		WL4842	
	High Speed		High Speed		High Speed		High Speed	
	Dry Coil	Wet Coil	Dry Coil	Wet Coil	Dry Coil	Wet Coil	Dry Coil	Wet Coil
.0	1775	1600	1850	1675	1600	1525	1700	1625
.1	1675	1525	1755	1600-	1525	1425	1600	1525
.2	1575	1425	1700	1525	1425	1350	1475	1400

REFRIGERANT CHARGE

The correct system R-22 charge is shown on the unit rating plate. Optimum unit performance will occur with a refrigerant charge resulting in a suction line temperature (6" from compressor) as shown in Table 7.

**TABLE 7
REFRIGERANT CHARGE**

Model	Airflow	95 OD Temperature	82 OD Temperature
WL602	1700	53 - 55	60 - 62
WL484	1550	54 - 56	65 - 67

The suction line temperatures in table above are based upon 80° F dry bulb / 67° F wet bulb (50% R.H.) temperature and rated airflow across the evaporator during cooling cycle.

**TABLE 8
RATED CFM AND ESP**

Model	Rated CFM	Rated ESP	Recommended Airflow Range
WL602N	1425	0.20	1775 - 1425 ①
WL6023	1425	0.20	1775 - 1425 ①
WL6022	1525	0.20	1850 - 1525 ②
WL4843	1350	0.20	1600 - 1350 ①
WL4842	1400	0.20	1700 - 1400 ②

① Rated CFM & ESP on High Speed tap with 14 x 28 return air filter grille

② Rated CFM & ESP on High Speed tap with 20 x 30 filter

**TABLE 9
MAXIMUM ESP OF OPERATION
ELECTRIC HEAT ONLY**

MODELS		ESP
WL6023 - ONLY	A05	.4
	A10	.3
	B09	.3

Values shown are for units equipped with standard 1" throwaway filters or 1" washable filters. Derate ESP by .15 for 2" pleated filters.

**TABLE 10
PRESSURE TABLE**

COOLING

Air Temperature Entering Outdoor Coil °F

Model	Return Air Temperature	Pressure	75	80	85	90	95	100	105	110	115
WL602	75 deg. DB 62 deg. WB	Low Side	71	72	74	75	76	77	78	78	79
		High Side	233	247	262	278	295	313	331	351	371
	80 deg. DB 67 deg. WB	Low Side	76	78	79	80	81	82	83	84	85
		High Side	237	253	269	285	303	321	340	360	381
	85 deg. DB 72 deg. WB	Low Side	84	85	85	86	87	88	89	90	91
		High Side	245	261	278	296	314	333	353	373	394
WL484	75 deg. DB 62 deg. WB	Low Side	73	74	76	78	79	80	82	83	84
		High Side	204	217	232	248	265	284	304	325	348
	80 deg. DB 67 deg. WB	Low Side	78	79	81	82	84	86	87	89	90
		High Side	210	223	238	254	272	291	312	334	357
	85 deg. DB 72 deg. WB	Low Side	84	85	87	88	90	92	93	95	97
		High Side	217	231	247	264	282	302	323	345	369

Low side pressure ± 2 PSIG
High side pressure ± 5 PSIG

Tables are based upon rated CFM (airflow) across the evaporator coil. If there is any doubt as to correct operating charge being in the system, the charge should be removed, system evacuated and recharged to serial plate instructions.

**TABLE 11
OPTIONAL ACCESSORIES**

Part Number	Description	WL6023A, WL6022A	WL6023B, WL6022B	WL4843A, WL4842A	WL4843B, WL4842B
CMC-15	Start Kit	X		X	
WMCB-09A	Circuit Breaker Kit	X			
WMCB-07B	Circuit Breaker Kit		X		
WMCB-08A	Circuit Breaker Kit			X	
WMCB-05B	Circuit Breaker Kit				X