INSTALLATION INSTRUCTIONS

WALL MOUNTED PACKAGE HEAT PUMPS

Models:

SH381

SH431

SH491



Bard Manufacturing Company
Bryan, Ohio 43506

Since 1914....Moving ahead just as planned.

Manual : 2100-410B
Supersedes: 2100-410A
File: Volume III Tab 17
Date: 02-24-04

CONTENTS

Getting Other Informations and Publications 1

Wall Mount General Information

Heat Pump Wall Mount Model Nomenclature	2
Shipping Damage	5
General	5
Duct Work	5
Filters	5
Fresh Air Intake	5
Condensate Drain – Evaporator	6

Installation Instructions

Wall Mounting Information	7
Mounting the Unit	7
Wiring – Main Power	12
Wiring – Low Voltage Wiring	12
Optional Outdoor Thermostat Applications	13
Heat Anticipation	15
Thermostat Indicator Lamps	15
Emergency Heat Position	15
Compressor Malfunction Light	15
Low Voltage Connections	15

Figures

Figure 1 Unit Dimensions	3
Figure 2 Fresh Air Damper Assembly	6
Figure 3 Mounting Instructions	8
Figure 4 Electric Heat Clearance	9
Figure 5 Wall Mounting Instructions	10
Figure 6 Wall Mounting Instructions	10
Figure 7 Common Wall Mounting Installations	11
Figure 8 Unit 24V Terminal Board	12
Figure 9 Compressor Cutoff Thermostat Wiring	13
Figure 10 Compressor Cutoff Thermostat Wiring	13
Figure 11 Electric Heat Hold-Off Wiring	14
Figure 12 Electric Heat Hold-Off Wiring	14
Figure 13 Start Up Procedure Decal	17
Figure 14 Defrost Control Board	19
Figure 15 Fan Blade Setting	22

Start Up

Important Installer Note	17
Crankcase Heaters	17
High Pressure Switch	17
Three Phase Scroll Compressor Start Up	17
Phase Monitor	18
Service Hints	18
Sequence of Operation	18
Pressure Service Ports	18
Defrost Cycle	19

Troubleshooting

Solid State Heat Pump Control Troubleshooting Procedure	20
Checking Temperature Sensor Outside Unit Circuit	21
Temperature vs. Resistance of Temperature	21
Fan Blade Setting Dimensions	22
Removal of Fan Shroud	22
Refrigerant Charge	22
Pressure Tables	24

Tables

Table 1 Electric Heat Table	2
Table 2 Electrical Specifications	4
Table 3 Thermostat Wire Size	13
Table 4 Wall Thermostat and Subbase Combinations	16
Table 5 Troubleshooting	20
Table 6 Fan Blade Dimensions	22
Table 7 Refrigerant Charge	22
Table 8 Recommended Operation Range	22
Table 9 Maximum ESP of Operation Electric Heat Only	22
Table 10 Indoor Blower Performance	23
Table 11 Pressure Table – Cooling	24
Table 12 Pressure Table – Heating	24

Getting Other Information and Publications

These publications can help you install the air conditioner or heat pump. You can usually find these at your local library or purchase them directly from the publisher. Be sure to consult current edition of each standard.

National Electrical Code ANSI/NFPA 70

Standard for the Installation ANSI/NFPA 90A
of Air Conditioning and
Ventilating Systems

Standard for Warm Air ANSI/NFPA 90B
Heating and Air
Conditioning Systems

Load Calculation for ACCA Manual J
Residential Winter and
Summer Air Conditioning

Duct Design for Residential ACCA Manual D
Winter and Summer Air Conditioning
and Equipment Selection

For more information, contact these publishers:

ACCA **Air Conditioning Contractors of America**
1712 New Hampshire Ave. N.W.
Washington, DC 20009
Telephone: (202) 483-9370
Fax: (202) 234-4721

ANSI **American National Standards Institute**
11 West Street, 13th Floor
New York, NY 10036
Telephone: (212) 642-4900
Fax: (212) 302-1286

ASHRAE **American Society of Heating Refrigerating,
and Air Conditioning Engineers, Inc.**
1791 Tullie Circle, N.E.
Atlanta, GA 30329-2305
Telephone: (404) 636-8400
Fax: (404) 321-5478

NFPA **National Fire Protection Association**
Batterymarch Park
P.O. Box 9101
Quincy, MA 02269-9901
Telephone: (800) 344-3555
Fax: (617) 984-7057

WALL MOUNT GENERAL INFORMATION

HEAT PUMP WALL MOUNT MODEL NOMENCLATURE

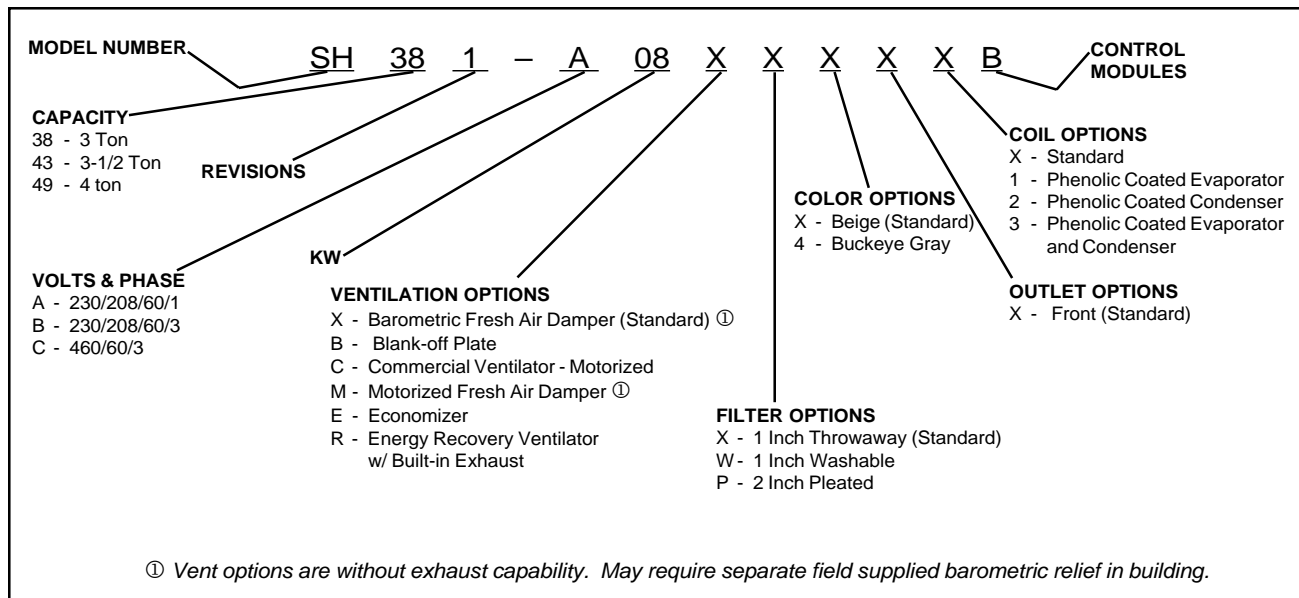
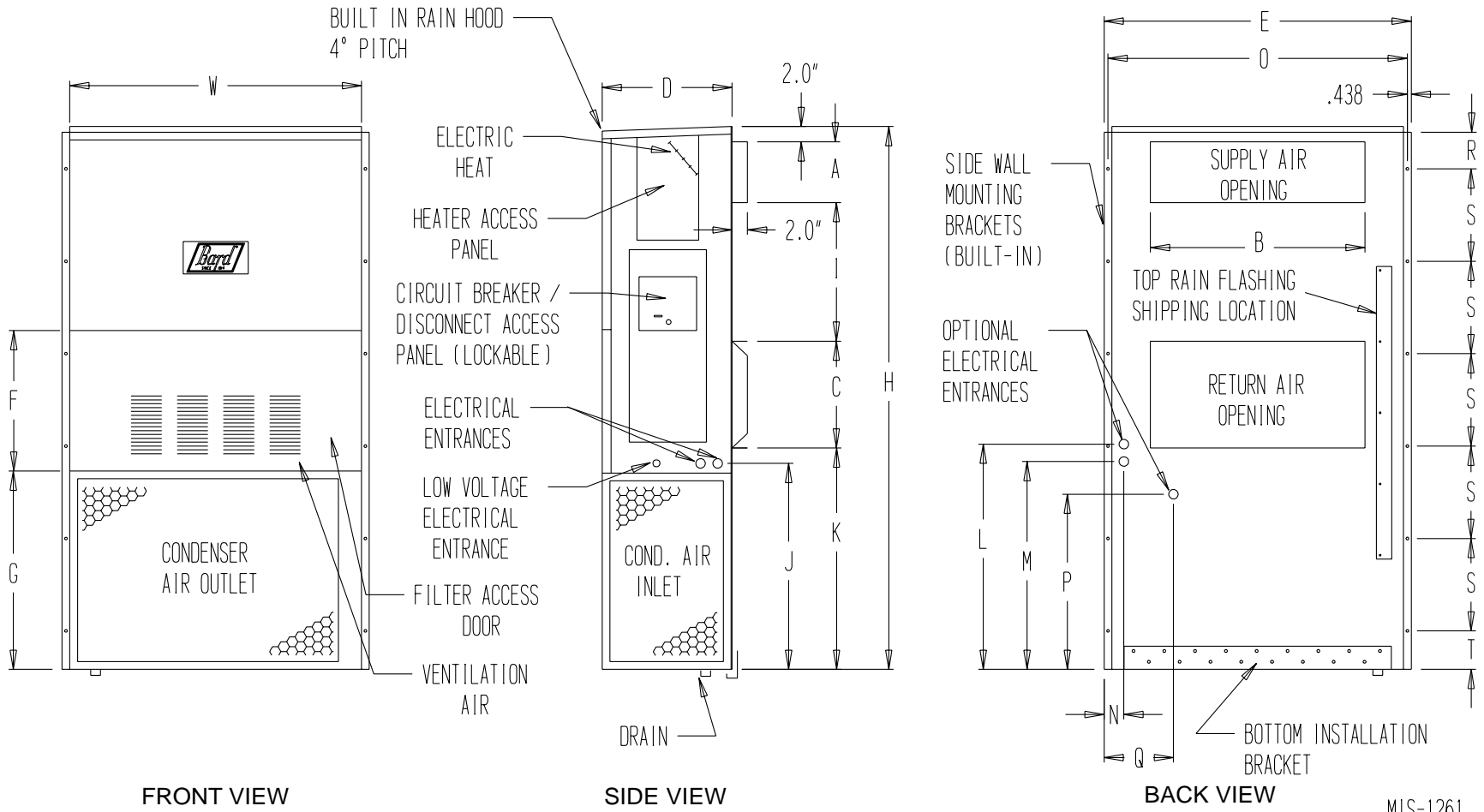

**TABLE 1
ELECTRIC HEAT TABLE**

Models	SH381-A SH431-A SH491-A				SH381-B SH431-B SH491-B				SH381-C SH431-C SH491-C	
	240-1		208-1		240-3		208-3		460-3	
	A	BTU	A	BTU	A	BTU	A	BTU	A	BTU
5	20.8	17065	18.1	12800						
6					14.4	20500	12.5	15360	7.2	20480
8	33.3	27280	28.8	20450						
9					21.7	30600	18.7	23030	10.8	30700
10	41.6	34130	36.2	25600						

**FIGURE 1
UNIT DIMENSIONS**

MODEL	Width	Depth	Height	Supply		Return																	
	(W)	(D)	(H)	A	B	C	B	E	F	G	I	J	K	L	M	N	O	P	Q	R	S	T	
SH381																							
SH431	42.075	22.432	84.875	9.88	29.88	15.88	29.88	43.88	19.10	31.66	30.00	32.68	26.94	34.69	32.43	3.37	42.88	23.88	10.00	2.00	16.00	1.88	
SH491																							



MIS-1261

**TABLE 2
ELECTRICAL SPECIFICATIONS**

Model	SINGLE CIRCUIT						DUAL CIRCUIT							
	Rated Volts & Phase	No. Field Power Circuits	③	①	②	②	③		①		②		②	
			Minimum Circuit Ampacity	Maximum External Fuse or Circuit Breaker	Field Power Wire Size	Ground Wire Size	Minimum Circuit Ampacity	Maximum External Fuse or Ckt. Breaker	Field Power Wire Size	Ground Wire Size	Field Power Wire Size	Ground Wire Size		
			CKT A	CKT B	CKT A	CKT B	CKT A	CKT B	CKT A	CKT B	CKT A	CKT B		
SH381-A00, A0Z A05 A08 A10	230/208-1	1 1 or 2 1 or 2 1 or 2	31 57 73 83	45 70 80 90	8 6 4 4	10 6 6 6	--- 31 31 31	--- 26 42 52	--- 50 50 50	--- 30 45 60	--- 8 8 8	--- 10 8 6	--- 10 10 10	--- 10 10 10
SH381-B00, B0Z B06 B09	230/208-3	1 1 1	23 41 50	35 45 50	8 8 6	10 10 10	--- --- ---	--- --- ---	--- --- ---	--- --- ---	--- --- ---	--- --- ---	--- --- ---	--- --- ---
SH381-C00, C0Z C06 C09	460-3	1 1 1	13 21 25	15 25 30	14 10 10	14 10 10	--- --- ---	--- --- ---	--- --- ---	--- --- ---	--- --- ---	--- --- ---	--- --- ---	--- --- ---
SH431-A00, A0Z A05 A08 A10	230/208-1	1 1 or 2 1 or 2 1 or 2	34 60 76 86	50 70 80 90	8 6 4 3	10 6 6 6	--- 34 34 34	--- 26 42 52	--- 50 50 50	--- 30 45 60	--- 8 8 8	--- 10 8 6	--- 10 10 10	--- 10 10 10
SH431-B00, B0Z B06 B09	230/208-3	1 1 1	25 43 52	35 50 60	8 8 6	10 10 10	--- --- ---	--- --- ---	--- --- ---	--- --- ---	--- --- ---	--- --- ---	--- --- ---	--- --- ---
SH431-C00, C0Z C06 C09	460-3	1 1 1	14 22 26	20 25 30	12 10 10	12 10 10	--- --- ---	--- --- ---	--- --- ---	--- --- ---	--- --- ---	--- --- ---	--- --- ---	--- --- ---
SH491-A00, A0Z A05 A08 A10	230/208-1	1 1 or 2 1 or 2 1 or 2	40 66 82 92	60 70 90 100	8 4 4 3	10 6 6 6	--- 40 40 40	--- 26 42 52	--- 50 50 50	--- 30 45 60	--- 8 8 8	--- 10 8 6	--- 10 10 10	--- 10 10 10
SH491-B00, B0Z B06 B09	230/208-3	1 1 1	29 47 57	45 60 60	10 8 6	10 10 10	--- --- ---	--- --- ---	--- --- ---	--- --- ---	--- --- ---	--- --- ---	--- --- ---	--- --- ---
SH491-C00, C0Z C06 C09	460-3	1 1 1	16 24 29	20 30 30	12 10 10	12 10 10	--- --- ---	--- --- ---	--- --- ---	--- --- ---	--- --- ---	--- --- ---	--- --- ---	--- --- ---

- ① Maximum size of the time delay fuse or HACR type circuit breaker for protection of field wiring conductors.
- ② Based on 75° C copper wire. All Wiring must conform to NEC and all local codes.
- ③ These "minimum Circuit Ampacity" values are to be used for sizing the field power conductors. Refer to the National Electric Code (latest revision), article 310 for power conductor sizing. *CAUTION: When more than one field power conductor circuit is run through one conduit, the conductors must be derated. Pay special attention to note 8 of table 310 regarding Ampacity Adjustment Factors when more than 3 conductors are in a raceway.*

SHIPPING DAMAGE

Upon receipt of equipment, the carton should be checked for external signs of shipping damage. If damage is found, the receiving party must contact the last carrier immediately, preferably in writing, requesting inspection by the carrier's agent.

GENERAL

The equipment covered in this manual is to be installed by trained, experienced service and installation technicians.

The refrigerant system is completely assembled and charged. All internal wiring is complete.

The unit is designed for use with or without duct work. Flanges are provided for attaching the supply and return ducts.

These instructions explain the recommended method to install the air cooled self-contained unit and the electrical wiring connections to the unit.

These instructions and any instructions packaged with any separate equipment, required to make up the entire air conditioning system should be carefully read before beginning the installation. Note particularly "Starting Procedure" and any tags and/or labels attached to the equipment.

While these instructions are intended as a general recommended guide, they do not supersede any national and/or local codes in any way. Authorities having jurisdiction should be consulted before the installation is made. See Page 1 for information on codes and standards.

Size of unit for a proposed installation should be based on heat loss calculation made according to methods of Air Conditioning Contractors of America (ACCA). The air duct should be installed in accordance with the Standards of the National Fire Protection Association for the Installation of Air Conditioning and Ventilating Systems of Other Than Residence Type, NFPA No. 90A, and Residence Type Warm Air Heating and Air Conditioning Systems, NFPA No. 90B. Where local regulations are at a variance with instructions, installer should adhere to local codes.

DUCT WORK

Any heat pump is more critical of proper operating charge and an adequate duct system than a straight air conditioning unit. All duct work, supply and return, must be properly sized for the design air flow requirement of the equipment. Air Conditioning Contractors of America (ACCA) is an excellent guide to proper sizing. All duct work or portions thereof not in the conditioned space should be properly insulated in order to both conserve energy and prevent condensation or moisture damage.

Design the duct work according to methods given by the Air Conditioning Contractors of America (ACCA). When duct runs through unheated spaces, it should be insulated with a minimum of one inch of insulation. Use insulation with a vapor barrier on the outside of the insulation. Flexible joints should be used to connect the duct work to the equipment in order to keep the noise transmission to a minimum.

A 1/4 inch clearance to combustible material for the first three feet of duct attached to the outlet air frame is required. See Wall Mounting Instructions and Figures 4 and 4A for further details.

Ducts through the walls must be insulated and all joints taped or sealed to prevent air or moisture entering the wall cavity.

Some installations may not require any return air duct. A metallic return air grille is required with installations not requiring a return air duct. The spacing between louvers on the grille shall not be larger than 5/8 inch.

NOTE: If no return air duct is used, applicable installation codes may limit this cabinet to installation only in a single story structure.

Any grille that meets with 5/8 inch louver criteria may be used. It is recommended that Bard Return Air Grille Kit RG2 through RG5 or RFG2 through RFG5 be installed when no return duct is used. Contact distributor or factory for ordering information. If using a return air filter grille, filters must be of sufficient size to allow a maximum velocity of 400 fpm.

FILTERS

A 1 inch throwaway filter is supplied with each unit. The filter slides into position making it easy to service. This filter can be serviced from the outside by removing the service door. A 1 inch washable filter and a 2 inch pleated filter are also available as optional accessories. The internal filter brackets are adjustable to

FRESH AIR INTAKE

All units are built with fresh air inlet slots punched in the service panel.

If the unit is equipped with a fresh air damper assembly, the assembly is shipped already attached to the unit. The damper blade is locked in the closed position. To allow the damper to operate, the maximum and minimum blade position stops must be installed. See Figure 2.

All capacity, efficiency and cost of operation information as required for Department of Energy "Energyguide" Fact Sheets is based upon the fresh air Blank-off plate in place and is recommended for maximum energy efficiency.

The blank-off plate is available upon request from the factory and is installed in place of the fresh air damper shipped with each unit.

CONDENSATE DRAIN – EVAPORATOR

A plastic drain hose extends from the drain pan at the top of the unit down to the unit base. There are openings in the unit base for the drain hose to pass through. In the event the drain hose is connected to a drain system of some type, it must be an open or vented type system to assure proper drainage.

**FIGURE 2
FRESH AIR DAMPER**

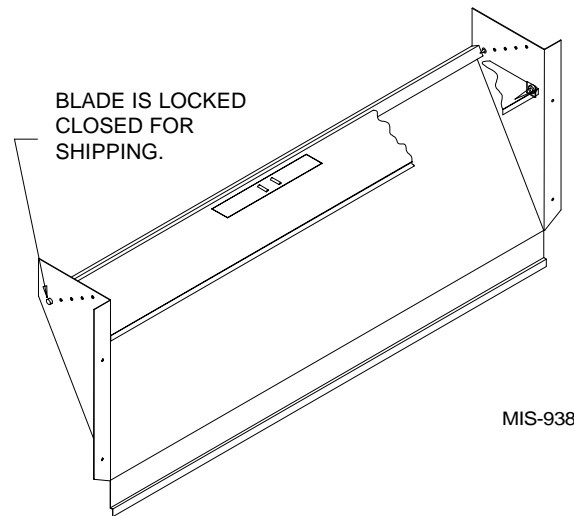

INSTALLATION INSTRUCTIONS

WALL MOUNTING INFORMATION

1. Two holes for the supply and return air openings must be cut through the wall as shown in Figure 3.
2. On wood frame walls, the wall construction must be strong and rigid enough to carry the weight of the unit without transmitting any unit vibration.

WARNING

Fire hazard can result if 1/4 inch clearance to combustible materials for supply air duct is not maintained. See Figure 3.

3. Concrete block walls must be thoroughly inspected to insure that they are capable of carrying the weight of the installed unit.

MOUNTING THE UNIT

1. These units are secured by wall mounting brackets which secure the unit to the outside wall surface at both sides. A bottom mounting bracket is provided for ease of installation, but is not required.
2. The unit itself is suitable for 0 inch clearance, but the supply air duct flange and the first 3 feet of supply air duct require a minimum of 1/4 inch clearance to combustible material. If a combustible wall use a minimum of 30-1/2" x 10-1/2" dimensions for sizing. However it is generally recommended that a 1 inch clearance is used for ease of installation and maintaining the required clearance to combustible material. The supply air opening would then be 32" x 12". See Figures 3 and 4 for details.

WARNING

Failure to provide the 1/4 inch clearance between the supply duct and a combustible surface for the first 3 feet of duct can result in fire causing property damage, injury or death.

3. Locate and mark lag bolt locations and bottom mounting bracket location. See Figure 3.
4. Mount bottom mounting bracket.
5. Hook top rain flashing under back bend of top. Top rain flashing is shipped with unit attached to back of unit on the right side.
6. Position unit in opening and secure with 5/16 lag bolts; use 3/4 inch diameter flat washers on the lag bolts.
7. Secure rain flashing to wall and caulk across entire length of top. See Figure 3.
8. For additional mounting rigidity, the return air and supply air frames or collars can be drilled and screwed or welded to the structural wall itself (depending upon wall construction). Be sure to observe required clearance if combustible wall.
9. On side by side installations, maintain a minimum of 20 inches clearance on right side to allow access to control panel and heat strips, and to allow proper airflow to the outdoor coil. Additional clearance may be required to meet local or national codes.

**FIGURE 4
MOUNTING INSTRUCTIONS**

DIMENSION CHART					
	DIM. "A"	DIM. "B"	DIM. "C"	DIM. "D"	DIM. "E"
Required dimensions to maintain 1/4" min. clearance from combustible materials	30 1/2"	10 1/2"	6 1/4"	1 1/4"	29 3/4"
Required dimensions to maintain 1" clearance from combustible materials	32"	12"	5 1/2"	2"	29"

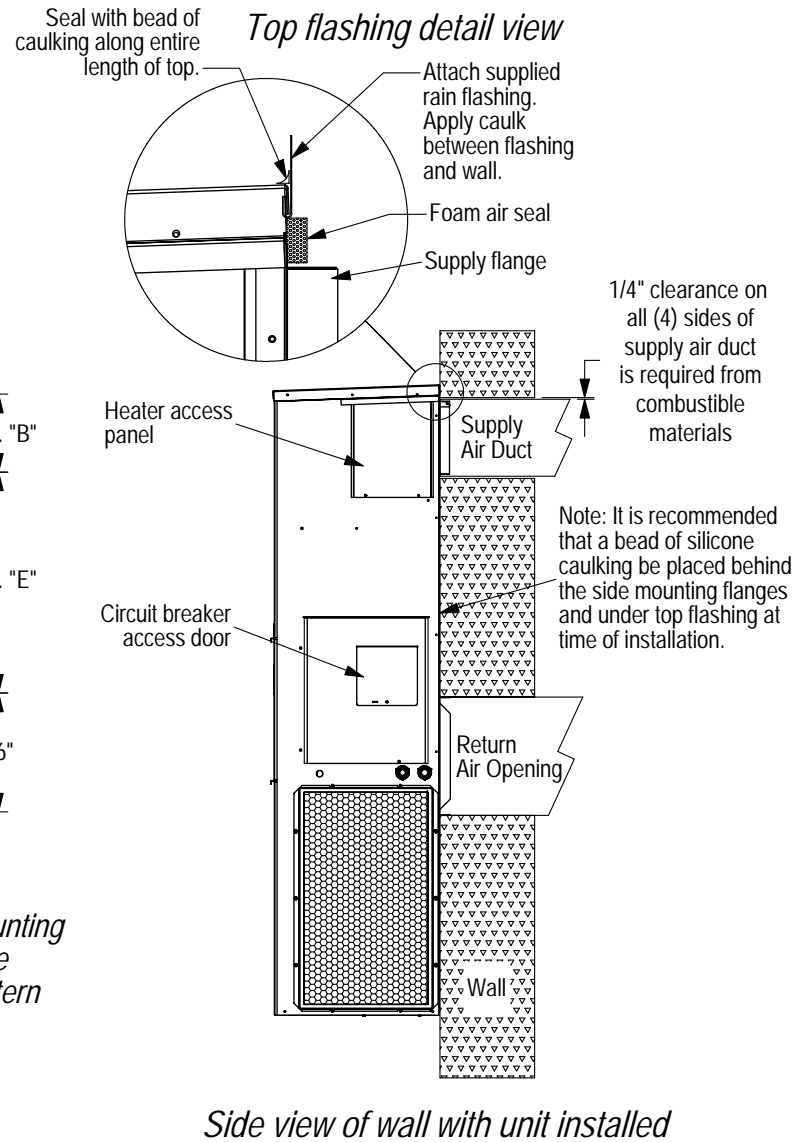
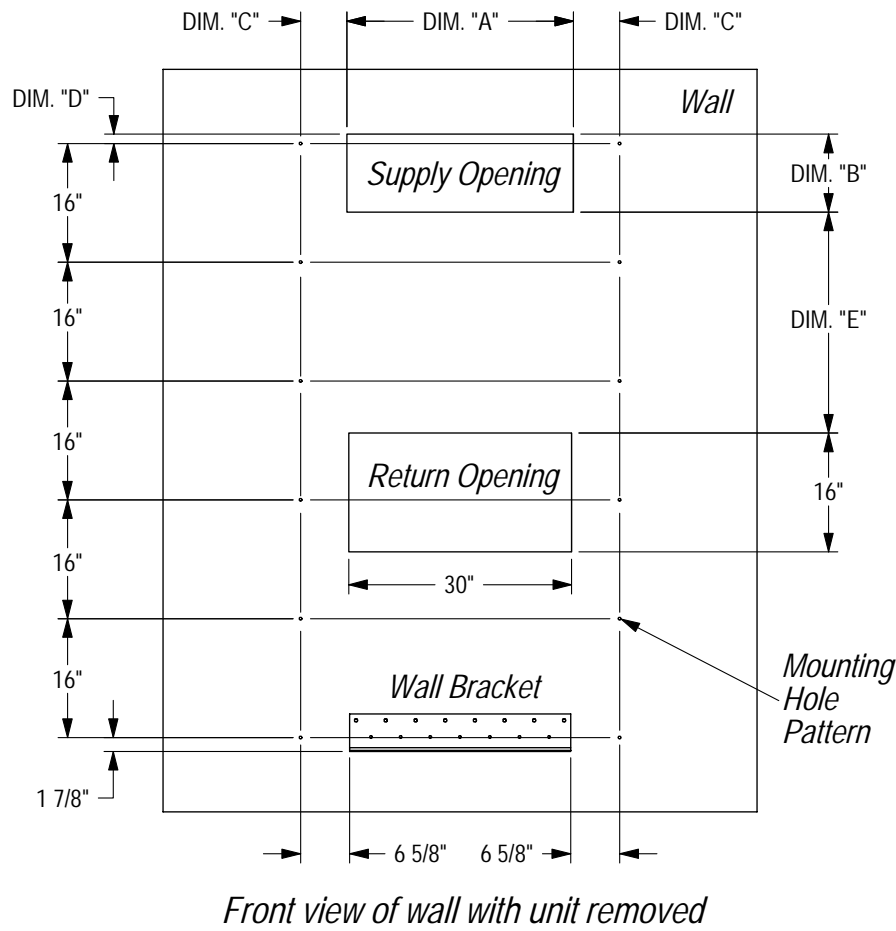

**FIGURE 4
ELECTRIC HEAT CLEARANCE**

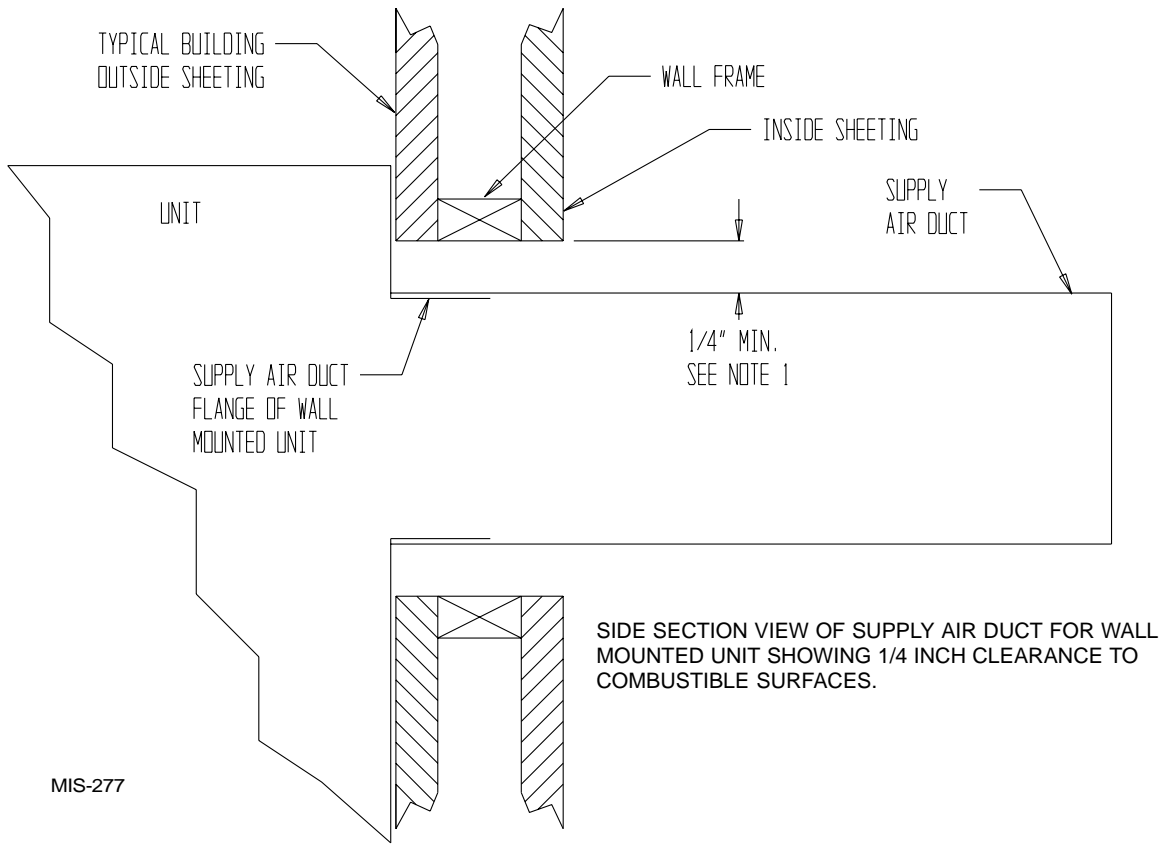

⚠ WARNING

A minimum of 1/4 inch clearance must be maintained between the supply air duct and combustible materials. This is required for the first 3 feet of ducting.

It is important to insure that the 1/4 inch minimum spacing is maintained at all points.

Failure to do this could result in overheating the combustible material and may result in a fire causing property damage, injury or death.

FIGURE 5 WALL MOUNTING INSTRUCTIONS

SEE FIGURE 4 – MOUNTING INSTRUCTIONS

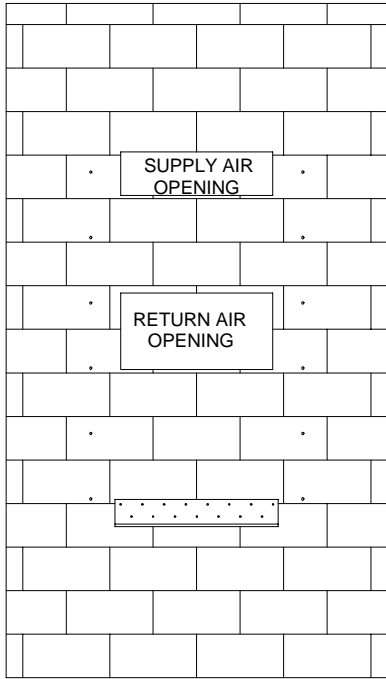

CONCRETE BLOCK WALL INSTALLATION

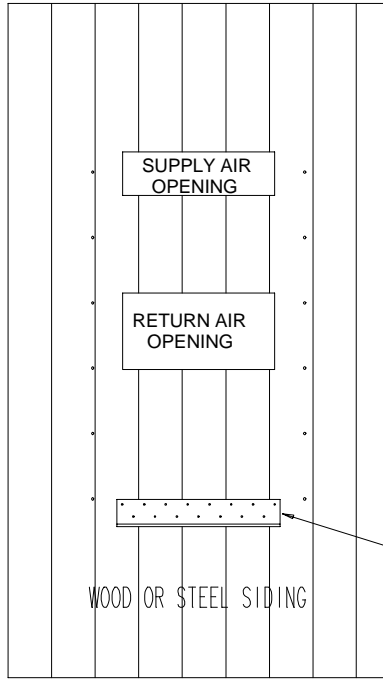

WOOD FRAME WALL INSTALLATION

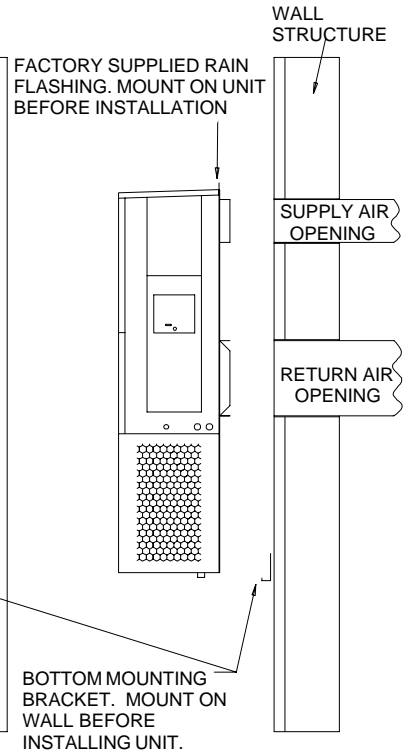

MIS-548

FIGURE 6 WALL MOUNTING INSTRUCTIONS

SEE UNIT DIMENSIONS, FIGURE 1, FOR ACTUAL DIMENSIONS

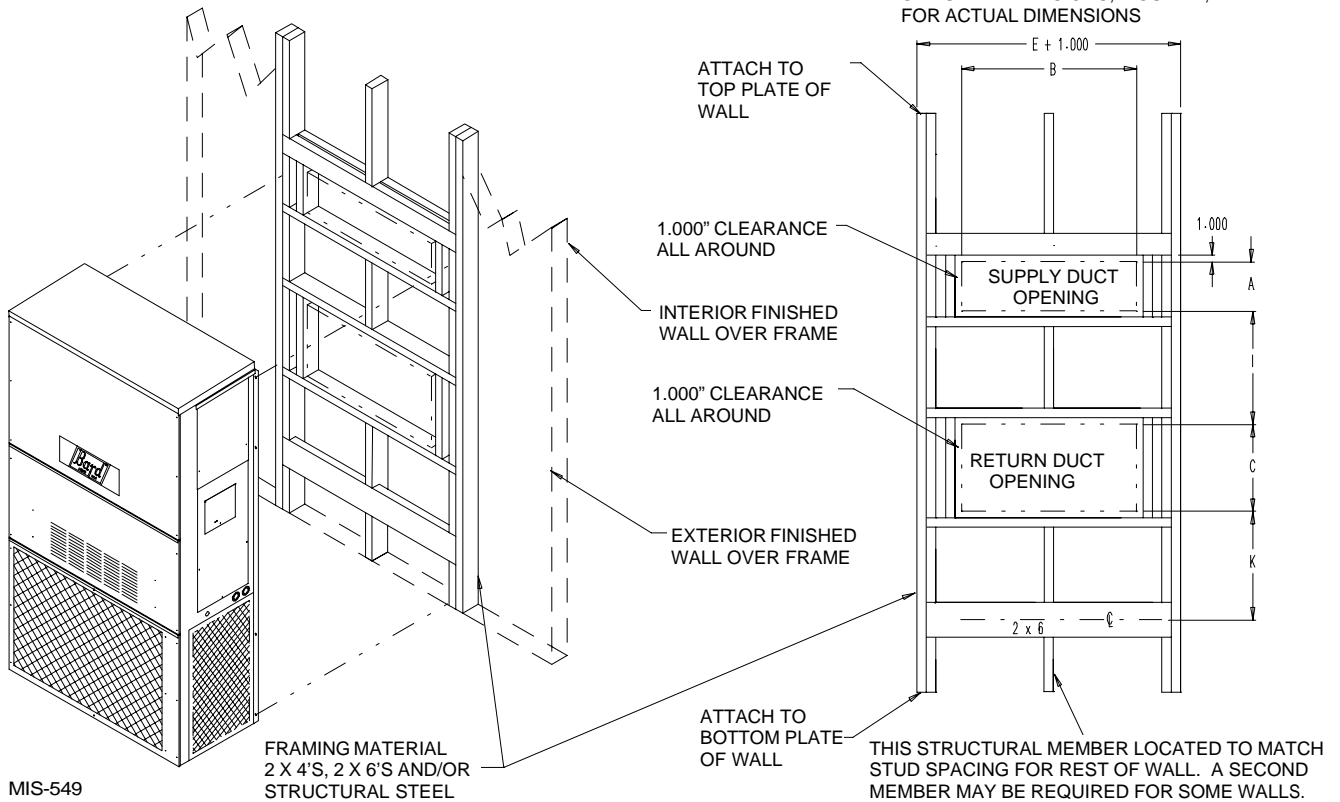

MIS-549

**FIGURE 7
COMMON WALL MOUNTING INSTALLATIONS**

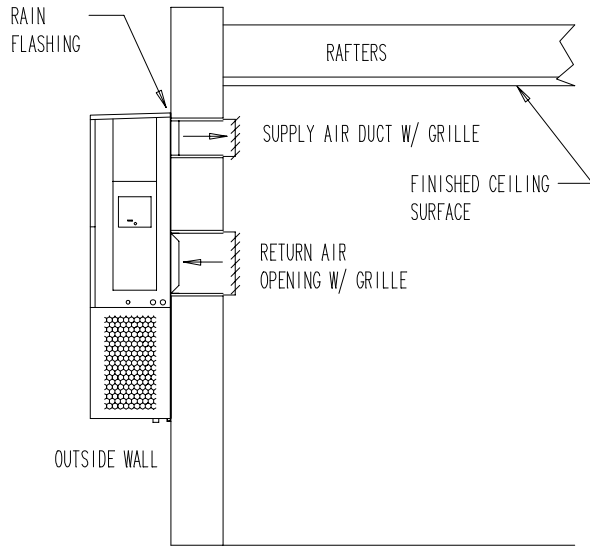

FREE AIR FLOW NO DUCT

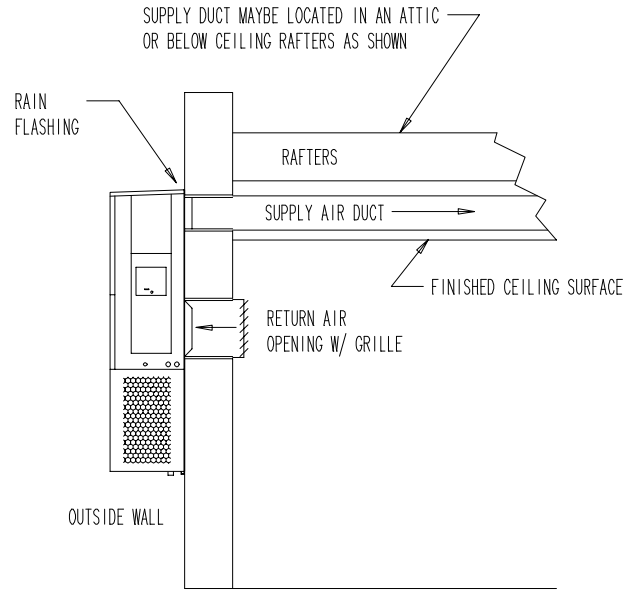

DUCTED SUPPLY RETURN AT UNIT

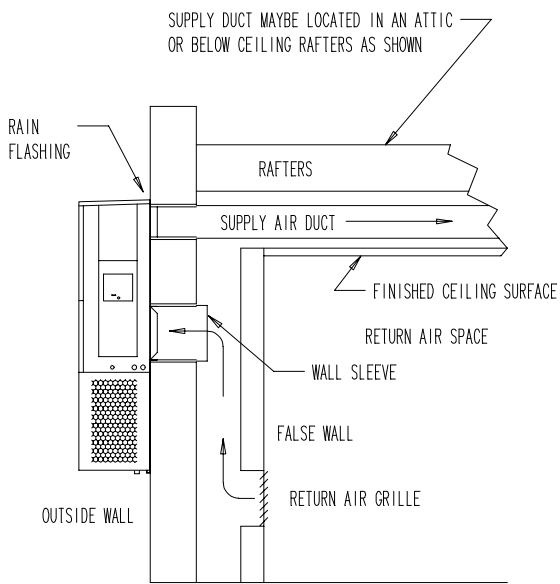

FALSE WALL INSTALLATION

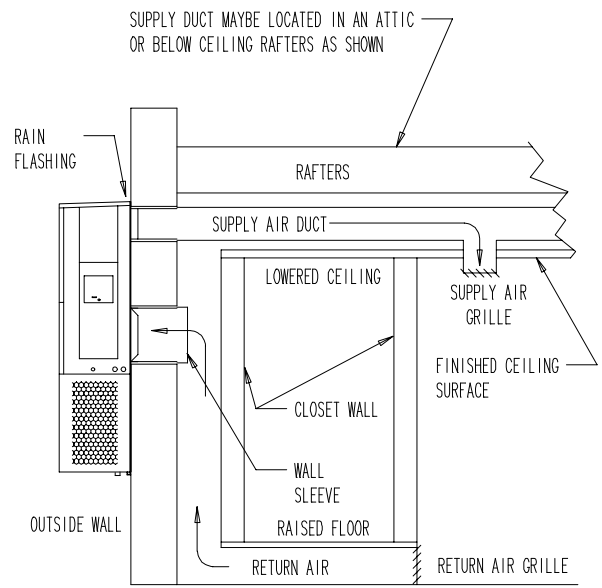

CLOSET INSTALLATION

WIRING – MAIN POWER

Refer to the unit rating plate for wire sizing information and maximum fuse or “HACR” type circuit breaker size. Each outdoor unit is marked with a “Minimum Circuit Ampacity”. This means that the field wiring used must be sized to carry that amount of current. Depending on the installed KW of electric heat, there may be two field power circuits required. If this is the case, the unit serial plate will so indicate. All models are suitable only for connection with copper wire. Each unit and/or wiring diagram will be marked “Use Copper Conductors Only”. These instructions **must be** adhered to. Refer to the National Electrical Code (NEC) for complete current carrying capacity data on the various insulation grades of wiring material. All wiring must conform to NEC and all local codes.

The electrical data lists fuse and wire sizes (75° C copper) for all models including the most commonly used heater sizes. Also shown are the number of field power circuits required for the various models with heaters.

The unit rating plate lists a “Maximum Time Delay Relay Fuse” or “HACR” type circuit breaker that is to be used with the equipment. The correct size must be used for proper circuit protection and also to assure that there will be no nuisance tripping due to the momentary high starting current of the compressor motor.

The disconnect access door on this unit may be locked to prevent unauthorized access to the disconnect. To convert for the locking capability, bend the tab locate in the bottom left hand corner of the disconnect opening under the disconnect access panel straight out. This tab will now line up with the slot in the door. When shut a padlock may be placed through the hole in the tab preventing entry.

See “Start Up” section for important information on three phase scroll compressor start ups.

WIRING – LOW VOLTAGE WIRING

230 / 208V, 1 phase and 3 phase equipment dual primary voltage transformers. All equipment leaves the factory wired on 240V tap. For 208V operation, reconnect from 240V to 208V tap. The acceptable operating voltage range for the 240 and 208V taps are:

TAP	RANGE
240	253 – 216
208	220 – 187

NOTE: The voltage should be measured at the field power connection point in the unit and while the unit is operating at full load (maximum amperage operating condition).

FIGURE 8
UNIT 24V TERMINAL BOARD

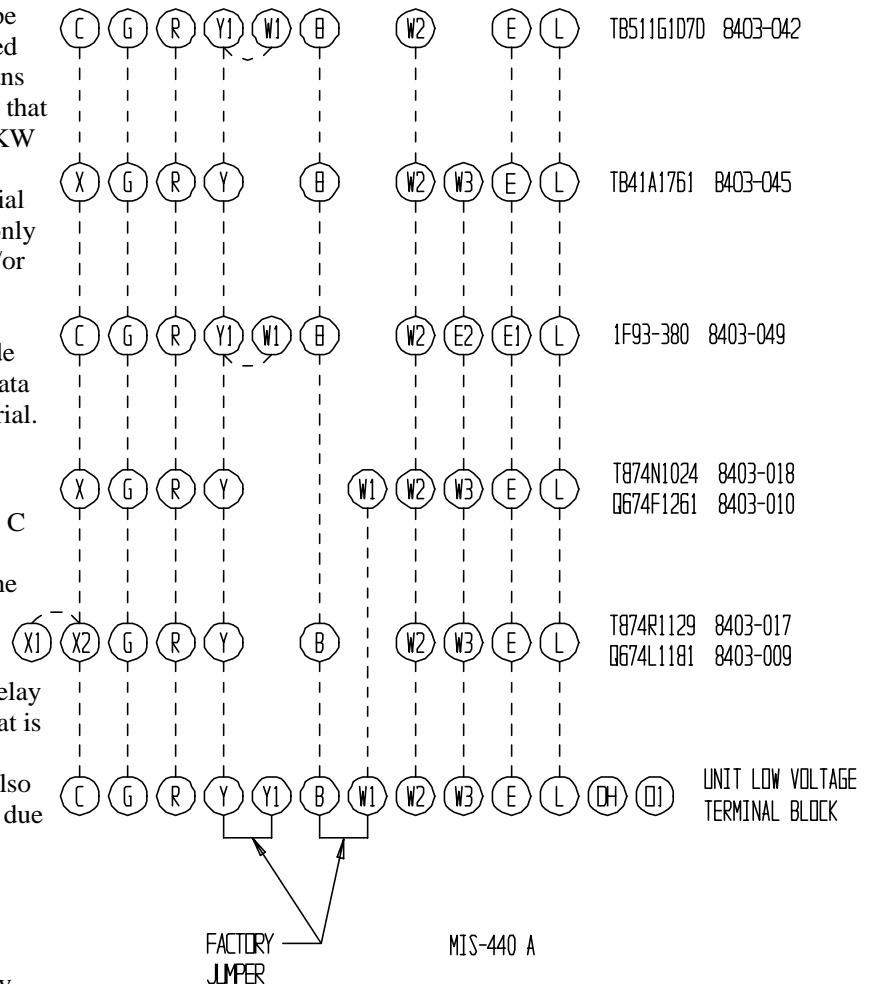

Nine (9) wires should be run from thermostat subbase to the 24V terminal board in the unit. A nine conductor, 18 gauge copper color-coded thermostat cable is recommended. The connection points are shown in Figure 8:

IMPORTANT

Only the thermostat and subbase combinations as shown above will work with this equipment.

The thermostat and subbase **must be** matched, and the correct operation can be assured only by proper selection and application of these parts.

**FIGURE 9
COMPRESSOR CUTOFF THERMOSTAT WIRING
4 – 10KW 1 PH – 6 & 9KW 3 PH**

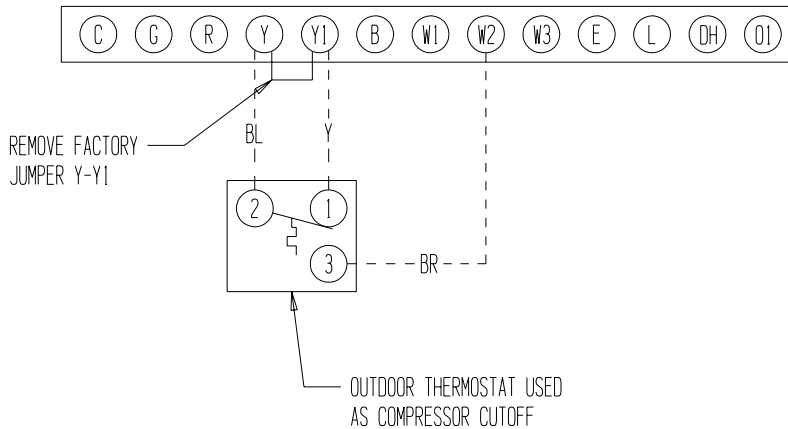

MIS-409

**FIGURE 10
COMPRESSOR CUTOFF THERMOSTAT WIRING
15 – 20KW 1 PH AND 3 PH**

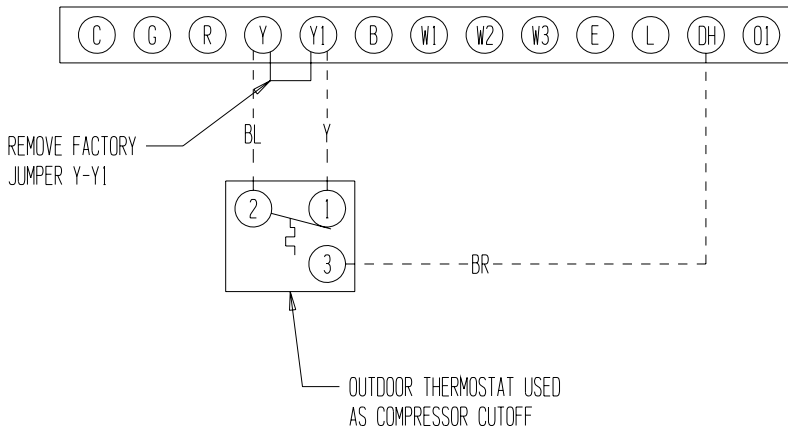

MIS-409

**TABLE 3
THERMOSTAT WIRE SIZE**

Transformer VA	FLA	Wire Gauge	Maximum Distance In Feet
55	2.3	20 gauge	45
		18 gauge	60
		16 gauge	100
		14 gauge	160
		12 gauge	250

OPTIONAL OUTDOOR THERMOSTAT APPLICATIONS

Since most equipment at the time of manufacture is not designated for any specific destination of the country and are installed in areas not approaching the lower outdoor temperature range, outdoor thermostats are not factory installed as standard equipment, but are offered as an option. There are also different applications for applying outdoor thermostats. The set point of either

type of outdoor thermostat application is variable with geographic region and sizing of the heating equipment to the individual structure. Utilization of the heating Application Data, and the heat loss calculation of the building are useful in determining the correct set points.

OPTIONAL COMPRESSOR CUTOFF THERMOSTAT (See Figures 9 and 10)

Heat pump compressor operation at outdoor temperatures below 0°F are neither desirable nor advantageous in term of efficiency. An outdoor thermostat can be applied to take the mechanical heating (compressor) off line, and send the (compressor) signal to energize electric heat in its place (to make electric heat first stage heating). This can also be applied to bank the quantity of available electric heat. For example: A heat pump operates with 10KW second stage heat – once the outdoor thermostat has switched then operates 15KW without the compressor as first stage heat.

ELECTRIC HEAT HOLD-OFF (See Figures 11 and 12)

In other applications, it is desirable to disable the operation of the electric heat until outdoor temperatures have reached a certain design point. This won't allow the electric heat to come on as second stage heating unless the outdoor temperature is below the set point of the outdoor thermostat. This is done to maximize

efficiency by utilizing the heat pump to bring the conditioned space temperature up, rather than cycling on the electric heat due a second stage call for heat from the thermostat on start-up coming off a night set-back condition or someone increasing the thermostat set point. (NOTE: Some programmable thermostats do have a built-in time delay for pulling in second stage heat when coming off set-back conditions.)

**FIGURE 11
ELECTRIC HEATHOLD-OFF WIRING
4 – 10KW 1 PH — 6 & 9KW 3 PH**

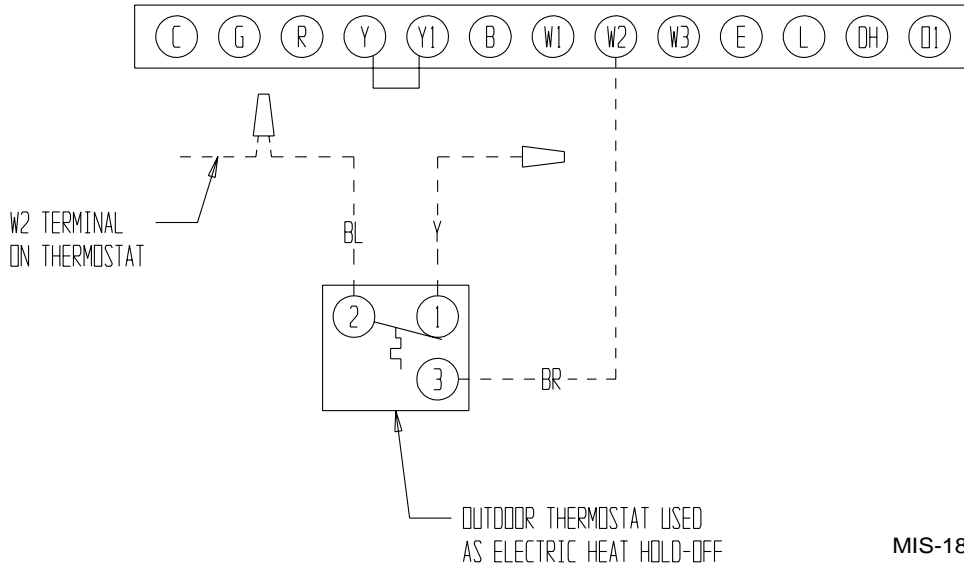

MIS-1858

**FIGURE 12
ELECTRIC HEATHOLD-OFF WIRING
15 – 20KW 1 PH & 3 PH**

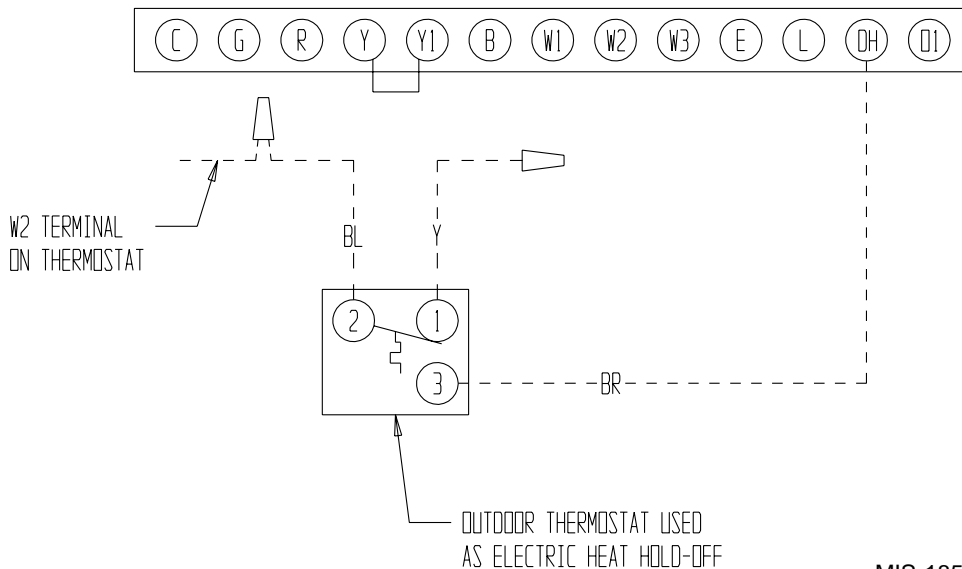

MIS-1858

HEAT ANTICIPATION

All of the thermostats shown in Table 4 have a fixed heat anticipator for stage 1 with no adjustment required. Stage 2 has an adjustable anticipator of the W2 connection and fixed for the W3 connection. Both the W2 and W3 circuits are controlled by the stage 2 bulb. The only heat anticipator that needs to be checked is stage 2 and it should be set to match the load carried by the W2 circuit. The normal factory wiring provides for only one electric heat contactor to be controlled by W2, and the anticipator should be set at .40A. If special field wiring is done, it is best to actually measure the load but a good rule is .40A for *each* heat contactor controlled by W2.

THERMOSTAT INDICATOR LAMPS

The red lamp marked “Em. Ht.” comes on and stays on whenever the system switch is placed in the emergency heat position. The green lamp marked “check” will come on if there is any problem that prevents the compressor from running when it is supposed to be.

EMERGENCY HEAT POSITION

The operator of the equipment must manually place the system switch in this position. This is done when there is a known problem with the unit, or when the green “check” lamp comes on indicating a problem.

COMPRESSOR MALFUNCTION LIGHT

Actuation of the green “check” lamp is accomplished by a relay output from the heat pump control board which is factory installed. Any condition such as loss of charge, high head pressure, etc., that will prevent compressor from operating will cause the green lamp to activate. This is a signal to the operator of the equipment to place system in emergency heat position.

LOW VOLTAGE CONNECTIONS

These units use a grounded 24 volt AC low voltage circuit.

The “R” terminal is the *hot* terminal and the “C” terminal is *grounded*.

“G” terminal is the *fan input*.

“Y” terminal is the *compressor input*.

“B” terminal is the *reversing valve input*. The reversing valve must be energized for heating mode.

“R” terminal is *24 VAC hot*.

“C” terminal is *24 VAC grounded*.

“L” terminal is *compressor lockout output*. This terminal is activated on a high or low pressure trip by the electronic heat pump control. This is a 24 VAC output.

“W2” terminal is *second stage heat* (if equipped).

“O1” terminal is the *ventilation input*. This terminal energizes any factory installed ventilation option.

“E” terminal is the *emergency heat input*. This terminal energizes the emergency heat relay.

NOTE: For total and proper control using DDC, a total of 6 controlled outputs are required (5 if no ventilation system is installed). For proper system operation under Emergency Heat conditions where the compressor needs to be deactivated, the B-W2-E outputs need to be energized. Removing the Y (compressor) signal alone turns the compressor off, but does not activate the additional circuitry embedded in the heat pump for proper and complete operation.

LOW VOLTAGE CONNECTIONS FOR DDC CONTROL

Fan Only	Energize G
Cooling Mode	Energize Y, G
Heat Pump Heating	Energize Y, G, B
2nd Stg Heating w/Heat Pump (if employed)	Energize G, W2, Y, B
Ventilation	Energize G, O1
Emergency Heat	Energize B, W2, E, G

**TABLE 4
WALL THERMOSTAT AND SUBBASE COMBINATIONS**

Thermostat	Subbase	Predominant Features
8403-045 (T841A1761)	---	1 stg. cool; 2 stg. heat; Mercury bulb Manual changeover
8403-017 (T874R1129)	8404-009 (Q674L1181)	2 stg. cool; 2 stg. heat; Mercury bulb Manual changeover ①
8403-018 (T874N1024)	8404-010 (Q674F1261)	2 stg. cool; 2 stg. heat; Mercury bulb Auto or Manual changeover ②
8403-042 (T8511G1070)	---	1 stg. cool; 2 stg. heat Electronic Non-Programmable Auto or Manual changeover
8403-049 (1F93-380)	---	2 stg. cool; 2 stg. heat Programmable Electronic Auto or Manual changeover

- ① No automatic changeover position – must manually place in heat or cool. Reversing valve remains energized at all times system switch is in heat position (except during defrost cycle). No pressure equalization noise when thermostat is satisfied on either heating or cooling.
- ② Allows thermostat to control both heating and cooling operation when set in “Auto” position. Reversing valve de-energizes at end of each “ON” heating cycle.

IMPORTANT

Both thermostat and subbase combinations shown above incorporate the following features: Man – Auto fan switch, Off – Heat – Em. Heat switch, and two (2) indicator lamps; one for emergency heat and one for compressor malfunction.

IMPORTANT INSTALLER NOTE

For improved start up performance wash the indoor coil with a dish washing detergent.

CRANKCASE HEATERS

SH491-B and -C are provided with compressor crankcase heat. All other models are not provided with crankcase heat. They are either single phase or the system refrigerant charge is not of sufficient quantity to require crankcase heat.

The SH491-B and -C models have a wrap around type heater located on the lower section of the compressor housing. This is an on/off heater that is controlled by the compressor contactor.

The label in Figure 13 is affixed to all SH491-B and -C units detailing start up procedure. This is *very* important. *Please read carefully.*

HIGH PRESSURE SWITCH

All models are supplied with a remote reset high pressure switch. If tripped, this pressure switch may be reset by turning the thermostat off then back on again.

THREE PHASE SCROLL COMPRESSOR START UP INFORMATION

Scroll compressors, like several other types of compressors, will only compress in one rotational direction. Direction of rotation is not an issue with single phase compressors since they will always start and run in the proper direction.

However, three phase compressors will rotate in either direction depending upon phasing of the power. Since there is a 50-50 chance of connecting power in such a way as to cause rotation in the reverse direction, verification of proper rotation must be made. All three phase units incorporate a phase monitor to ensure proper field wiring. See the "Phase Monitor" section later in this manual.

Verification of *proper rotation* must be made any time a compressor is changed or rewired. If improper rotation is corrected at this time there will be no negative impact on the durability of the compressor.

However, reverse operation for over one hour may have a negative impact on the bearing due to oil pump out.

NOTE: If compressor is allowed to run in reverse rotation for several minutes, the compressor's internal protector will trip.

FIGURE 13
START UP LABEL

IMPORTANT

THESE PROCEDURES MUST BE FOLLOWED AT INITIAL START UP AND AT ANY TIME POWER HAS BEEN REMOVED FOR 12 HOURS OR LONGER.

To prevent compressor damage which may result from the presence of liquid refrigerant in the compressor crankcase:

1. Make certain the room thermostat is in the "off" position. (The compressor is not to operate.)
2. Apply power by closing the system disconnect switch. This energizes the compressor heater which evaporates the liquid refrigerant in the crankcase.
3. Allow 4 hours or 60 minutes per pound of refrigerant in the system as noted on the unit rating plate, whichever is greater.
4. After proper elapsed time the thermostat may be set to operate the compressor.
5. Except as required for safety while servicing, do not open system disconnect switch.

7961-411

All three phase ZR3 compressors are wired identically internally. As a result, once the correct phasing is determined for a specific system or installation, connecting properly phased power leads to the same Fusite terminal should maintain proper rotation direction.

Verification of proper rotation direction is made by observing that suction pressure drops and discharge pressure rises when the compressor is energized. Reverse rotation also results in an elevated sound level over that with correct rotations, as well as, substantially reduced current draw compared to tabulate values.

The direction of rotation of the compressor may be changed by reversing any two line connections to the unit.

PHASE MONITOR

All units with three phase compressors are equipped with a 3 phase line monitor to prevent compressor damage due to phase reversal.

The phase monitor in this unit is equipped with two LEDs. If the Y signal is present at the phase monitor and phases are correct, the green LED will light. If phases are reversed, the red fault LED will be lit and compressor operation is inhibited.

If a fault condition occurs, reverse two of the supply leads to the unit. Do not reverse any of the unit factory wires as damage may occur.

SERVICE HINTS

1. Caution homeowner to maintain clean air filters at all times. Also, not to needlessly close off supply and return air registers. This reduces air flow through the system, which shortens equipment service life as well as increasing operating costs.
2. Switching to heating cycle at 75° F or higher outside temperature may cause a nuisance trip of the remote reset high pressure switch. Turn thermostat off then on to reset the high pressure switch.
3. The heat pump wall thermostats perform multiple functions. Be sure that all function switches are correctly set for the desired operating mode before trying to diagnose any reported service problems.
4. Check all power fuses or circuit breakers to be sure they are the correct rating.
5. Periodic cleaning of the outdoor coil to permit full and unrestricted airflow circulation is essential.

SEQUENCE OF OPERATION

COOLING – Circuit R-Y makes at thermostat pulling in compressor contactor, starting the compressor and outdoor motor. The G (indoor motor) circuit is automatically completed on any call for cooling operation or can be energized by manual fan switch on subbase for constant air circulation.

HEATING – A 24V solenoid coil on reversing valve controls heating cycle operation. Two thermostat options, one allowing “Auto” changeover from cycle to cycle and the other constantly energizing solenoid coil during heating season and thus eliminating pressure equalization noise except during defrost, are to be used. On “Auto” option a circuit is completed from R-W1 and R-Y on each heating “on” cycle, energizing reversing valve solenoid and pulling in compressor contactor starting compressor and outdoor motor. R-G also make starting indoor blower motor. Heat pump heating cycle now in operation. The second option has no “Auto” changeover position, but instead energizes the reversing valve solenoid constantly whenever the system switch on subbase is placed in “Heat” position, the “B” terminal being constantly energized from R. A thermostat demand for heat completes R-Y circuit, pulling in compressor contactor starting compressor and outdoor motor. R-G also make starting indoor blower motor.

PRESSURE SERVICE PORTS

High and low pressure service ports are installed on all units so that the system operating pressures can be observed. Pressure tables can be found later in the manual covering all models on both cooling and heating cycles. It is imperative to match the correct pressure table to the unit by model number.

DEFROST CYCLE

The defrost cycle is controlled by temperature and time on the solid state heat pump control. See Figure 14.

When the outdoor temperature is in the lower 40° F temperature range or colder, the outdoor coil temperature is 32° F or below. This coil temperature is sensed by the coil temperature sensor mounted near the bottom of the outdoor coil. Once coil temperature reaches 30° F or below, the coil temperature sensor sends a signal to the control logic of the heat pump control and the defrost timer will start.

After 60 minutes at 30° F or below, the heat pump control will place the system in the defrost mode.

During the defrost mode, the refrigerant cycle switches back to the cooling cycle, the outdoor motor stops, electric heaters are energized, and hot gas passing through the outdoor coil melts any accumulated frost. When the temperature rises to approximately 57° F, the coil temperature sensor will send a signal to the heat pump control which will return the system to heating operations automatically.

If some abnormal or temporary condition such as a high wind causes the heat pump to have a prolonged defrost cycle, the heat pump control will restore the system to heating operation automatically after 10 minutes.

The heat pump defrost control board has an option of 30, 60 or 90 minutes setting. All models are shipped from the factory on the 60 minute pin. If special circumstances require a change to another time, remove the wire from the 60 minute terminal and reconnect to the desired terminal. The manufacturer's recommendation is for 60 minute defrost cycles. Refer to Figure 14

There is a cycle speed up jumper on the control. This can be used to reduce the time between defrost cycle operation without waiting for time to elapse.

Use a small screwdriver or other metallic object, or another 1/4 inch QC, to short between the *SPEEDUP* terminals to accelerate the HPC timer and initiate defrost.

Be careful not to touch any other terminals with the instrument used to short the *SPEEDUP* terminals. It may take up to 10 seconds with the *SPEEDUP* terminals shorted for the speedup to be completed and the defrost cycle to start.

As soon as the defrost cycle kicks in remove the shorting instrument from the SPEEDUP terminals. Otherwise the timing will remain accelerated and run through the 1 minute minimum defrost length sequence in a matter of seconds and will automatically terminate the defrost sequence.

There is an initiate defrost jumper (sen jump) on the control that can be used at any outdoor ambient during the heating cycle to simulate a 0° coil temperature. This can be used to check defrost operation of the unit without waiting for the outdoor ambient to fall into the defrost region.

By placing a jumper across the *SEN JMP* terminals (a 1/4 inch QC terminal works best) the defrost sensor mounted on the outdoor coil is shunted out and will activate the timing circuit. This permits the defrost cycle to be checked out in warmer weather conditions without the outdoor temperature having to fall into the defrost region.

In order to terminate the defrost test the *SEN JMP* jumper must be removed. If left in place too long the compressor could stop due to the high pressure control

opening because of high pressure condition created by operating in the cooling mode with outdoor fan off. Pressure will rise fairly fast as there is likely no actual frost on the outdoor coil in this artificial test condition.

There is also a 5 minute compressor time delay function built into the HPC. This is to protect the compressor from short cycling conditions. In some instances it is helpful to the service technician to override or speed up this timing period, and shorting out the *SPEEDUP* terminals for a few seconds can do this.

**FIGURE 14
DEFROST CONTROL BOARD**

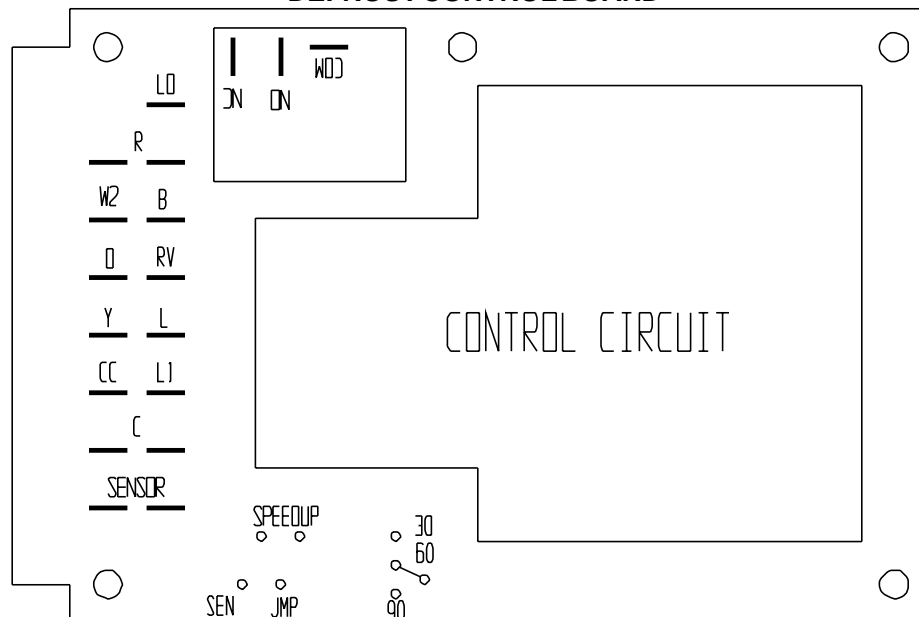

MIS-1174

TROUBLESHOOTING

SOLID STATE HEAT PUMP CONTROL TROUBLESHOOTING PROCEDURE

1. Turn on AC power supply to indoor and outdoor units.
2. Turn thermostat blower switch to fan on. The indoor blower should start. (If it doesn't, troubleshoot indoor unit and correct problem.)
3. Turn thermostat blower switch to auto position. Indoor blower should stop.
4. Set system switch to heat or cool. Adjust thermostat to call for heat or cool. The indoor blower, compressor, and outdoor fan should start.

NOTE: If there was no power to 24 volt transformer, the compressor and outdoor fan motor will not start for 5 minutes. This is because of the compressor short cycle protection.

**TABLE 5
TROUBLESHOOTING**

Symptom	Possible Causes	What to Check	How to Dheck or Repair
Compressor contactor does not energize (heating or cooling)	Control circuit wiring	Check for R connectio at unit and 24 volt between R - C	Run R connection to outdoor unit to power heat pump control.
	Compressor lock out	1. Check for 24V between L1-C on heat pump control. 2. Check across high pressure switch	1. If no voltage between L1-C, turn thermostat off and on again to reset high pressure switch. 2. If high pressure switch is open and will not reset, replace high pressure switch.
	Compressor short cycle protection	Check for 24 V between CC-C and Y-C on heat pump control.	If not voltage between CC-C, jumper speed up terminal, and within 10 seconds power should appear between CC-C. Remove speed up jumper after 10 seconds.
	Heat pump control defective	Check all other possible causes. Manual 2100-065	Replace heat pump control.
	Contactor defective	Check for open or shorted coil winding.	Replace contactor.
	Power phasing not correct	Check for red LED on phase monitor (3 phase units only).	Switch two power leads to the unit.
Fan outdoor motor does not run (cooling or heating except during defrost)	Motor defective	Check for open or shorted motor winding.	Replace motor.
	Motor capacitor defective	Check capacitor ratng. Check for open or shorted capacitor.	Replace capacitor.
	Heat pump control defective	Check across fan relay on heat pump control (Com-NC).	Replace heat pump control.
Reversing valve does not energize (heating only)	Reversing valve solenoid coil defective	Check for open or shorted coil.	Replace solenoid Coil.
	Heat pump control defective	Check for 24V between RV-C and B-C.	1. Check control circuit wiring. 2. Replace heat pump control.
Unit will not go into defrost (heating only)	Temperature sensor or heat pump control defective	Disconnect temperature sensor from board and jumper across speed up terminals and sen jump terminals. This should caruse the unit to go through a defrost cycle within one minute.	1. If unit goes through defrost cycle, replace temperature sensor. 2. If unit does not go through defrost cycle, replace heat pump control.
Unit will not come out of defrost (heating only)	Temperature sensor or heat pump control defective	Jumper across speed up terminals. This should cause the unit to come out of defrost within one minute.	1. If unit comes out of defrost cycle replace temperature sensor. 2. If unit does not come out of defrost cycle, replace heat pump control.

CHECKING TEMPERATURE SENSOR OUTSIDE UNIT CIRCUIT

1. Disconnect temperature sensor from board and from outdoor coil.
2. Use an ohmmeter and measure the resistance of the sensor. Also use ohmmeter to check for short or open.
3. Check resistance reading to chart of resistance use sensor ambient temperature. (Tolerance of part is $\pm 10\%$)
4. If sensor resistance reads very low, then sensor is shorted and will not allow proper operation of the heat pump control.
5. If sensor is out of tolerance, shorted, open, or reads very low ohms then it should be replaced.

TEMPERATURE F VS RESISTANCE R OF TEMPERATURE

F	R	F	R	F	R
-25.0	196871	25.0	39898	75.0	10501
-24.0	190099	26.0	38757	76.0	10247
-23.0	183585	27.0	37652	77.0	10000
-22.0	177318	28.0	36583	78.0	9760
-21.0	171289	29.0	35548	79.0	9526
-20.0	165487	30.0	34545	80.0	9299
-19.0	159904	31.0	33574	81.0	9077
-18.0	154529	32.0	32634	82.0	8862
-17.0	149355	33.0	31723	83.0	8653
-16.0	144374	34.0	30840	84.0	8449
-15.0	139576	35.0	29986	85.0	8250
-14.0	134956	36.0	29157	86.0	8057
-13.0	130506	37.0	28355	87.0	7869
-12.0	126219	38.0	27577	88.0	7686
-11.0	122089	39.0	26823	89.0	7507
-10.0	118108	40.0	26092	90.0	7334
-9.0	114272	41.0	25383	91.0	7165
-8.0	110575	42.0	24696	92.0	7000
-7.0	107010	43.0	24030	93.0	6840
-6.0	103574	44.0	23384	94.0	6683
-5.0	100260	45.0	22758	95.0	6531
-4.0	97064	46.0	22150	96.0	6383
-3.0	93981	47.0	21561	97.0	6239
-2.0	91008	48.0	20989	98.0	6098
-1.0	88139	49.0	20435	99.0	5961
0.0	85371	50.0	19896	100.0	5827
1.0	82699	51.0	19374	101.0	5697
2.0	80121	52.0	18867	102.0	5570
3.0	77632	53.0	18375	103.0	5446
4.0	75230	54.0	17898	104.0	5326
5.0	72910	55.0	17434	105.0	5208
6.0	70670	56.0	16984	106.0	5094
7.0	68507	57.0	16547	107.0	4982
8.0	66418	58.0	16122	108.0	4873
9.0	64399	59.0	15710	109.0	4767
10.0	62449	60.0	15310	110.0	4663
11.0	60565	61.0	14921	111.0	4562
12.0	58745	62.0	14544	112.0	4464
13.0	56985	63.0	14177	113.0	4367
14.0	55284	64.0	13820	114.0	4274
15.0	53640	65.0	13474	115.0	4182
16.0	52051	66.0	13137	116.0	4093
17.0	50514	67.0	12810	117.0	4006
18.0	49028	68.0	12492	118.0	3921
19.0	47590	69.0	12183	119.0	3838
20.0	46200	70.0	11883	120.0	3757
21.0	44855	71.0	11591	121.0	3678
22.0	43554	72.0	11307	122.0	3601
23.0	42295	73.0	11031	123.0	3526
24.0	41077	74.0	10762	124.0	3452

FAN BLADE SETTING DIMENSIONS

Shown in Figure 15 are the correct fan blade setting dimensions for proper air delivery across the outdoor coil.

Any service work requiring removal or adjustment in the fan and/or motor area will require that the dimensions below be checked and blade adjusted in or out on the motor shaft accordingly.

**FIGURE 15
FAN BLADE SETTING**

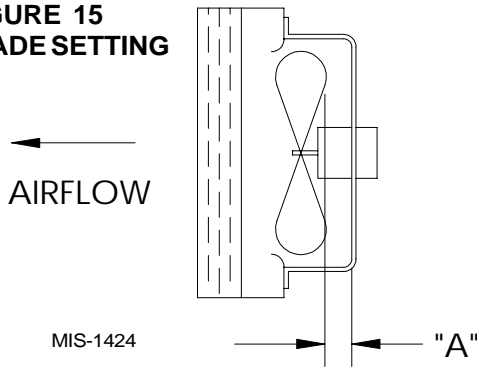

**TABLE 6
FAN BLADE SETTING
DIMENSION**

Model	Dimension A
SH381 SH431 SH491	1.75

REMOVAL OF FAN SHROUD

1. Disconnect all power to the unit.
2. Remove the screws holding both grilles, one on each side of unit, and remove grilles.
3. Remove screws holding fan shroud to condenser and bottom. Nine (9) screws.
4. Unwire condenser fan motor.
5. Slide complete motor, fan blade, and shroud assembly out the left side of the unit.
6. Service motor/fan as needed.
7. Reverse steps to reinstall.

REFRIGERANT CHARGE

The correct system R-22 charge is shown on the unit rating plate. Optimum unit performance will occur with a refrigerant charge resulting in a suction line temperature (6" from compressor) as shown in Table 7.

**TABLE 7
REFRIGERANT CHARGE**

Model	Rated Airflow	95 OD Temperature	82 OD Temperature
SH381	1100	71 - 73	68 - 70
SH431	1300	72 - 75	69 - 71
SH491	1250	68 - 70	64 - 66

The suction line temperatures in Table 7 are based upon 80° F dry bulb / 67° F wet bulb (50% R.H.) temperature and rated airflow across the evaporator during cooling cycle.

**TABLE 8
RECOMMENDED OPERATING RANGES**

Model	Rated CFM *	Rated ESP *	Recommended Airflow Range
SH381	1100	.15	1250 - 850
SH431	1300	.15	1475 - 1100
SH491	1250	.20	1475 - 1100

* Rated CFM and ESP on high speed tap.

**TABLE 9
MAXIMUM ESP OF OPERATION
ELECTRIC HEAT ONLY**

Model	SH381			SH431 SH491	
	High Speed	Med Speed	Low Speed	High Speed	Med Speed
-A05	0.3	0.3	0.3	0.3	0.3
-A08	0.3	0.3	0.3	0.4	0.4
-A10	0.3	0.3	0.2	0.3	0.3
-B06	0.4	0.3	0.3	0.3	0.3
-B09	0.4	0.3	0.3	0.3	0.3
-C06	0.3	0.3	0.3	0.3	0.3
-C09	0.3	0.3	0.3	0.3	0.3

Values shown are for units equipped with standard 1 inch throwaway filter or 1 inch washable filter. Derate ESP by .15 for 2 inch pleated filters.

**TABLE 10
INDOOR BLOWER PERFORMANCE – CFM @ 230V / 460V**

E.S.P. In H ₂ O	SH381						SH431, SH491			
	High Speed		Medium Speed		Low Speed		High Speed		Medium Speed	
	Dry Coil	Wet Coil	Dry Coil	Wet Coil	Dry Coil	Wet Coil	Dry Coil	Wet Coil	Dry Coil	Wet Coil
.0	1625	1475	1425	1325	1125	1100	1700	1550	1475	1375
.1	1475	1350	1325	1200	1100	1000	1550	1400	1375	1250
.2	1350	1150	1200	1025	1000	850	1400	1250	1250	1100
.3	1150	825	1025	750	825	675	1250	1100	1100	825

Subtract .08 static for 2" filter

NOTE: SH431 and SH491 are shipped with the indoor blower on medium speed for free blow applications. Move to high speed for ducted applications.

NOTE: SH381 is shipped with the indoor blower on low speed for free blow applications. Move to medium speed for ducted applications.

**TABLE 11
PRESSURE TABLE**

COOLING

Air Temperature Entering Outdoor Coil °F

Model	Return Air Temperature	Pressure	75	80	85	90	95	100	105	110	115
SH381	75 deg. DB	Low Side	77	78	79	80	81	82	84	85	85
	62 deg. WB	High Side	190	203	217	233	249	266	286	305	326
	80 deg. DB	Low Side	82	83	85	86	87	88	90	91	91
SH431	67 deg. WB	High Side	195	208	223	239	255	273	293	313	334
	85 deg. DB	Low Side	85	86	88	89	90	91	93	94	94
	72 deg. WB	High Side	202	215	231	247	264	283	303	324	346
SH491	75 deg. DB	Low Side	74	74	75	76	77	78	79	81	83
	62 deg. WB	High Side	194	209	224	240	257	275	293	312	332
	80 deg. DB	Low Side	79	79	80	81	82	83	85	87	89
SH491	67 deg. WB	High Side	199	214	230	246	264	282	300	320	340
	85 deg. DB	Low Side	82	82	83	84	85	86	88	90	92
	72 deg. WB	High Side	206	221	238	255	273	292	311	331	352
SH491	75 deg. DB	Low Side	72	72	78	73	74	75	77	79	80
	62 deg. WB	High Side	198	213	228	244	260	278	296	316	335
	80 deg. DB	Low Side	77	77	77	78	79	80	82	84	86
SH491	67 deg. WB	High Side	203	218	234	250	267	285	304	324	344
	85 deg. DB	Low Side	80	80	80	81	82	86	85	87	89
	72 deg. WB	High Side	210	226	242	259	276	295	315	335	356

Low side pressure ± 2 PSIG

High side pressure ± 5 PSIG

Tables are based upon rated CFM (airflow) across the evaporator coil. If there is any doubt as to correct operating charge being in the system, the charge should be removed, system evacuated and recharged to serial plate instruction.

**TABLE 12
PRESSURE TABLE**

HEATING

Air Temperature Entering Outdoor Coil °F

Model	Return Air Temperature	Pressure	0	5	10	15	20	25	30	35	40	45	50	55	60
SH381	70 deg.	Low Side	15	19	24	28	33	37	42	46	51	56	60	65	70
		High Side	156	161	167	173	179	185	192	198	205	212	219	227	234
SH431	70 deg.	Low Side	17	20	23	27	30	34	39	43	48	53	58	63	69
		High Side	162	164	167	170	175	180	185	192	199	207	216	226	236
SH491	70 deg.	Low Side	15	19	23	27	32	36	41	45	50	54	59	64	69
		High Side	135	155	174	191	206	218	229	237	243	247	249	252	255

Low side pressure ± 2 PSIG

High side pressure ± 5 PSIG

Tables are based upon rated CFM (airflow) across the evaporator coil. If there is any doubt as to correct operating charge being in the system, the charge should be removed, system evacuated and recharged to serial plate instruction.