INSTALLATION INSTRUCTIONS

ELECTRIC HEAT PACKAGES

Models:

EHWA02-AXD
EHWA02-AXH
EHWA03-AXH
EHWA03-AXK
EHWA05-AXH
EHWA05-AXK

FOR USE WITH WA SERIES
WALL MOUNTED AIR CONDITIONERS
SEE TABLE 1 FOR MODEL USAGE



BARD MANUFACTURING COMPANY
Bryan, Ohio 43506
Since 1914...Moving ahead, just as planned.

Manual: 2100-415A
Supersedes: 2100-415
File: Volume III, Tab 18
Date: 11-05-02

CLIMATE CONTROL SOLUTIONS

CONTENTS

General Information

- Description of Equipment 1
- Nomenclature 1
- Important 1
- Shipping Damage 1
- Unpacking Electric Heat Package 1
- Wiring Main Power 2

Installation

- Installation of Heater Package 3

Tables

- Table 1 Heater Usage by Model Matrix 1
- Table 2 Electrical Data 2
- Table 3 Terminal and Screw Mounting 6

Figures

- Figure 1 Electrical Connections 2
- Figure 2 Installation of Heater Package 4
WA24, WA30, WA36 Models
- Figure 2A Installation of Heater Package 5
WA423, WA484, WA602 Models
- Figure 3 Rod Support and Screw Mounting 6
- Figure 4A - 4D Terminal Identification 7
- Figure 5 Wiring Directions 8
WA24, WA30, WA36 Models
- Figure 5A Wiring Directions 9
WA423, WA484, WA602 Models
- Figure 6 Marking Serial Plate 10

GENERAL INFORMATION

DESCRIPTION OF EQUIPMENT

The EHWA series electric heater packages are field installable heater packages suitable for use with Bard wall mount hi boy air conditioners and heat pumps. The packages consist of the electric heat strip, the heater control base which includes the heat contactors, and circuit breaker or pull disconnects, installation instructions and wiring diagrams. See Table 1 for nominal electrical data and BTU output. Before installation, check unit serial plate to insure the heater package model that you intend to install is listed as a heater package that is suitable for use with the Bard wall mount hi boy unit. See Figure 6.

NOMENCLATURE

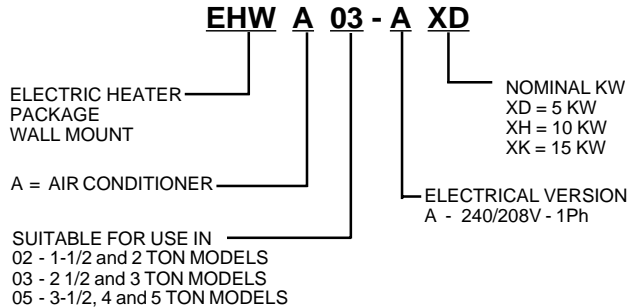

IMPORTANT

The equipment covered in this manual is to be installed by trained, experienced service and installation technicians.

SHIPPING DAMAGE

Upon receipt of equipment, the carton should be checked for external signs of shipping damage. If damage is found, the receiving party must contact the last carrier immediately, preferably in writing, requesting inspection by the carrier's agent.

UNPACKING ELECTRIC HEAT PACKAGE

Remove the heat package from the shipping carton. The heat package must consist of the following:

1. Basic heater.
2. Electric heat control base and wiring.
3. Installation instructions.
4. Wiring diagram (2), one to be applied to unit.
5. Adhesive label to remark serial plate to indicate new model number. This is attached to the front of these instructions.

**TABLE 1
HEATER USAGE BY MODEL MATRIX**

	WA182-A	WA242-A	WA253-A	WA302-A	WA361-A	WA372-A	WA423-A	WA484-A	WA602-A
EHWA02-AXD	X	X	X						
EHWA02-AXH	X	X	X						
EHWA03-AXH				X	X	X			
EHWA03-AXK				X	X	X			
EHWA05-AXH							X	X	X
EHWA05-AXK							X	X	X

WARNING

Only use factory provided heaters in approved combinations of heater models to unit models as shown on this table. Failure to use approved combinations as shown or modification to heaters, could result in fire causing damage, bodily injury or death.

WIRING MAIN POWER

1. On all installations, size unit power supply wiring for the minimum circuit ampacity requirement for the unit and heater package combination listed on the unit serial plate.

For existing installations, addition or upgrading of a heater package may require that larger supply wires

be run to the unit. Resize all power supply wires for the minimum circuit ampacity rating listed on the unit serial plate that is applicable for your combination of unit and heater package.

2. All heater packages covered by this manual are factory wired for a single supply circuit. The following heater packages are field convertible to a dual supply circuit if required or desired.

EHWA05-AXK EHWA03-AXK

3. To convert the above heater packages to dual circuit configuration before installation, loosen 4 screws holding jumper bar in place. Remove jumper bar. Circuit A + B are now identified on the heater package. See Figure 1.

Wire should be sized to the minimum circuit ampacity as specified on the serial plates of units that accept these heater packages for circuits A + B.

! WARNING

Install properly sized power supply leads for the unit/heater combination minimum circuit ampacity as listed on the unit serial plate. Hazard of fire. Failure to install properly sized conductors could result in fire.

**FIGURE 1
ELECTRICAL CONNECTIONS**

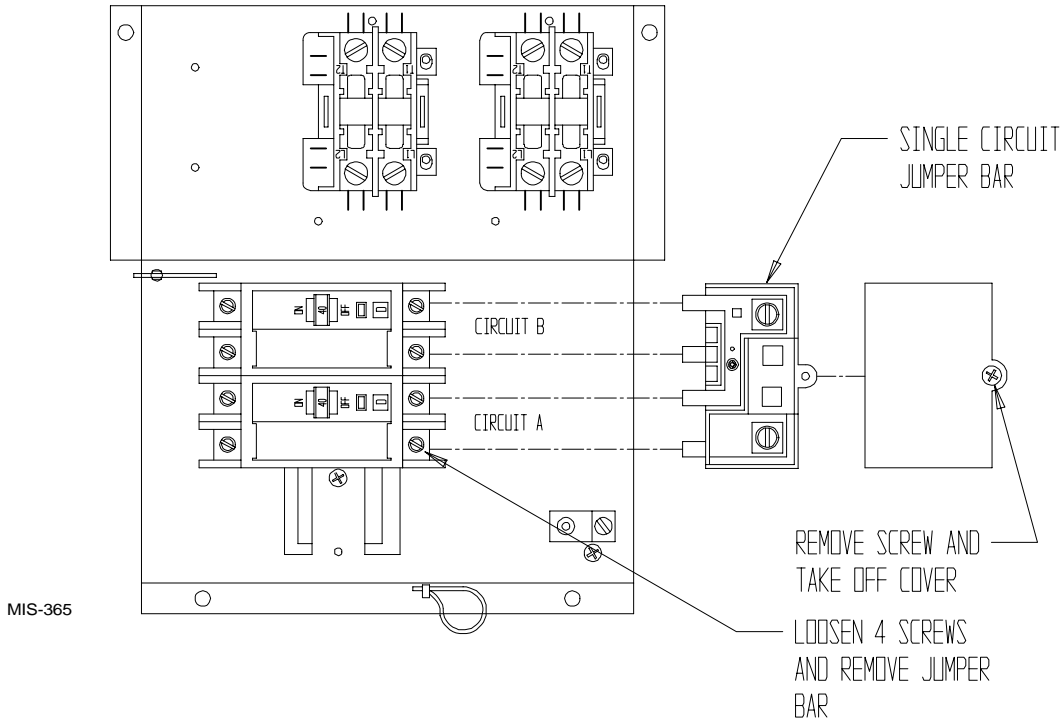

**TABLE 2
ELECTRICAL DATA AND BTU OUTPUT**

Heater Package Model	Volts	Phase	Nominal KW	Nominal BTU
EHWA02-AXD	240/208	1	5 / 3.75	17,065 / 12,800
EHWA02-AXH	240/208	1	10 / 7.5	34,130 / 25,600
EHWA03-AXH	240/208	1	10 / 7.5	34,130 / 25,600
EHWA03-AXK	240/208	1	15 / 11.25	51,200 / 38,400
EHWA05-AXH	240/208	1	10 / 7.5	34,130 / 25,600
EHWA05-AXK	240/208	1	15 / 11.25	51,200 / 38,400

INSTALLATION OF HEATER PACKAGE

1. Disconnect all power to unit before installation.

 WARNING
Disconnect all power to unit before installing heater package. Hazard of electrical shock. Failure to disconnect power could result in injury or death.

2. Before installation, check unit serial plate to insure that the heater package model that you intend to install is listed as a heater package suitable for use with the unit.

Under no circumstances shall a heater package be installed in a unit if the model number of the heater package does not appear on the unit serial plate.

 WARNING
Install only heater packages listed on unit serial plate. Hazard of fire or electrical shock. Failure to install listed heater package could result in fire, injury or death.

3. Remove electric heater access panel and control panel cover, both inner and outer. See Figure 2 or 2A.
4. All heaters are installed with the thermal cutoffs positioned to the top of the unit. Install heat strip(s) through heater access opening. Position heat strip support rod in heater support hole 1, 2, or 3 as indicated in Table 1 and Figure 3. Secure in place with 2 sheet metal screws in mounting holes as indicated in Table 1 and Figure 3.

On heater packages with 2 heat strips 10KW heater first in position closest to the outlet air frame. See Figures 4C.

5. Install heater control base into top of control panel as shown in Figure 5. Secure with 4 sheet metal screws provided.
6. Plug male 6 pin connector into mating connector mounted in control panel. See Figure 5.
7. Connect red compressor supply lead to L1 of terminal block. Connect black compressor supply lead to L2 of terminal block. If 3 phase, connect yellow supply lead to L3 of terminal block. See Figure 5 or 5A and wiring diagram.
8. Route wires from heater control base up through raceway or grommet in top right corner of control panel to the heaters. See Figure 5 or 5A.
9. Wire heater package per wiring diagram supplied with this heater package. All wires are stamped with wire numbers that correspond with terminal numbers on the wiring diagram and stamped numbers on the heat strip. Limit switch wires are terminated with insulated quick connect terminals. See Figure 4.
10. Attach adhesive wiring diagram directly above unit wiring diagram on inner control panel cover.
11. Recheck all wiring. Break out appropriate circuit breaker tabs on inner control panel cover to allow trip lever to protrude. Replace control panel and heater access panels
12. Resupply power to the unit and check for proper operation.
13. Remark serial plate with self-adhesive label attached to the front of this manual. See Figure 6.

FIGURE 2
INSTALLATION OF HEATER PACKAGE
WA24, WA30 AND WA36 MODELS

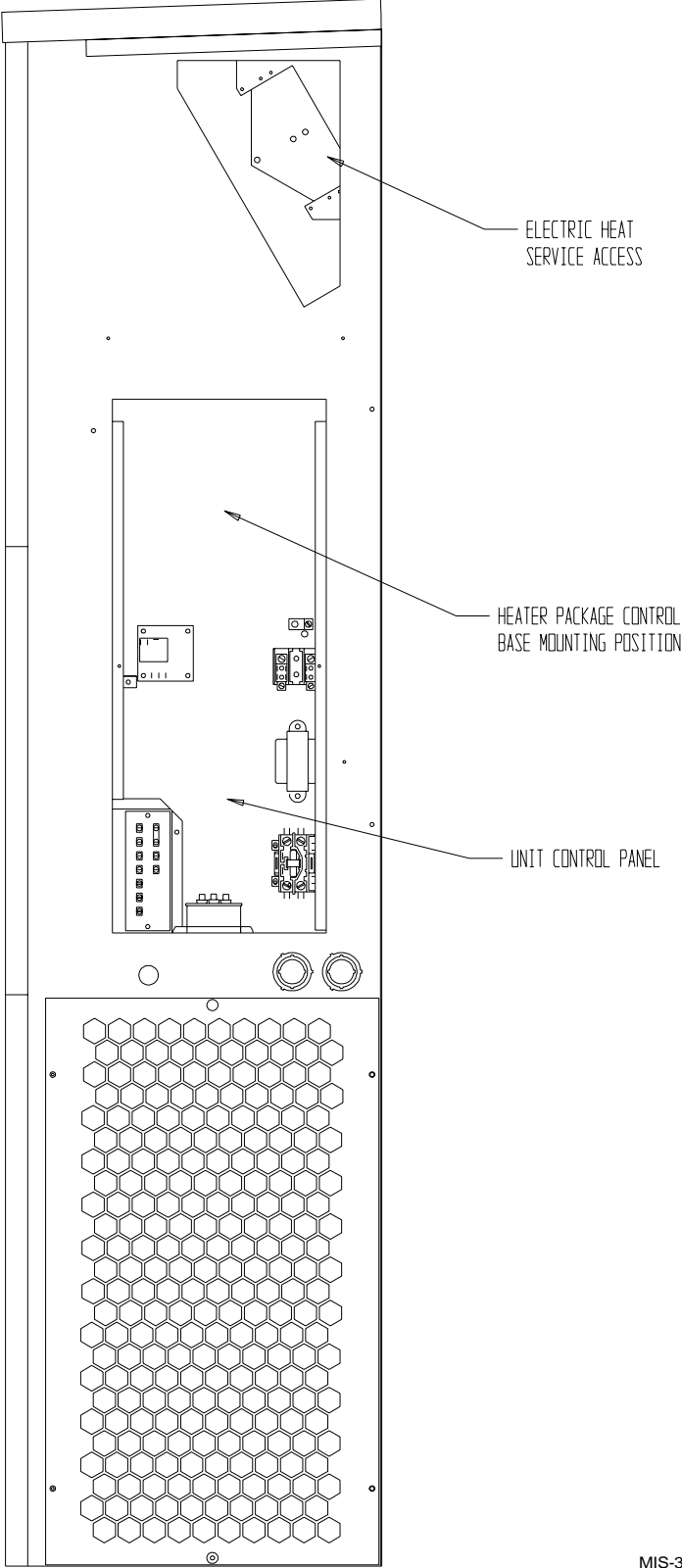

MIS-361

FIGURE 2A
INSTALLATION OF HEATER PACKAGE
WA423, WA484 AND WA602 MODELS

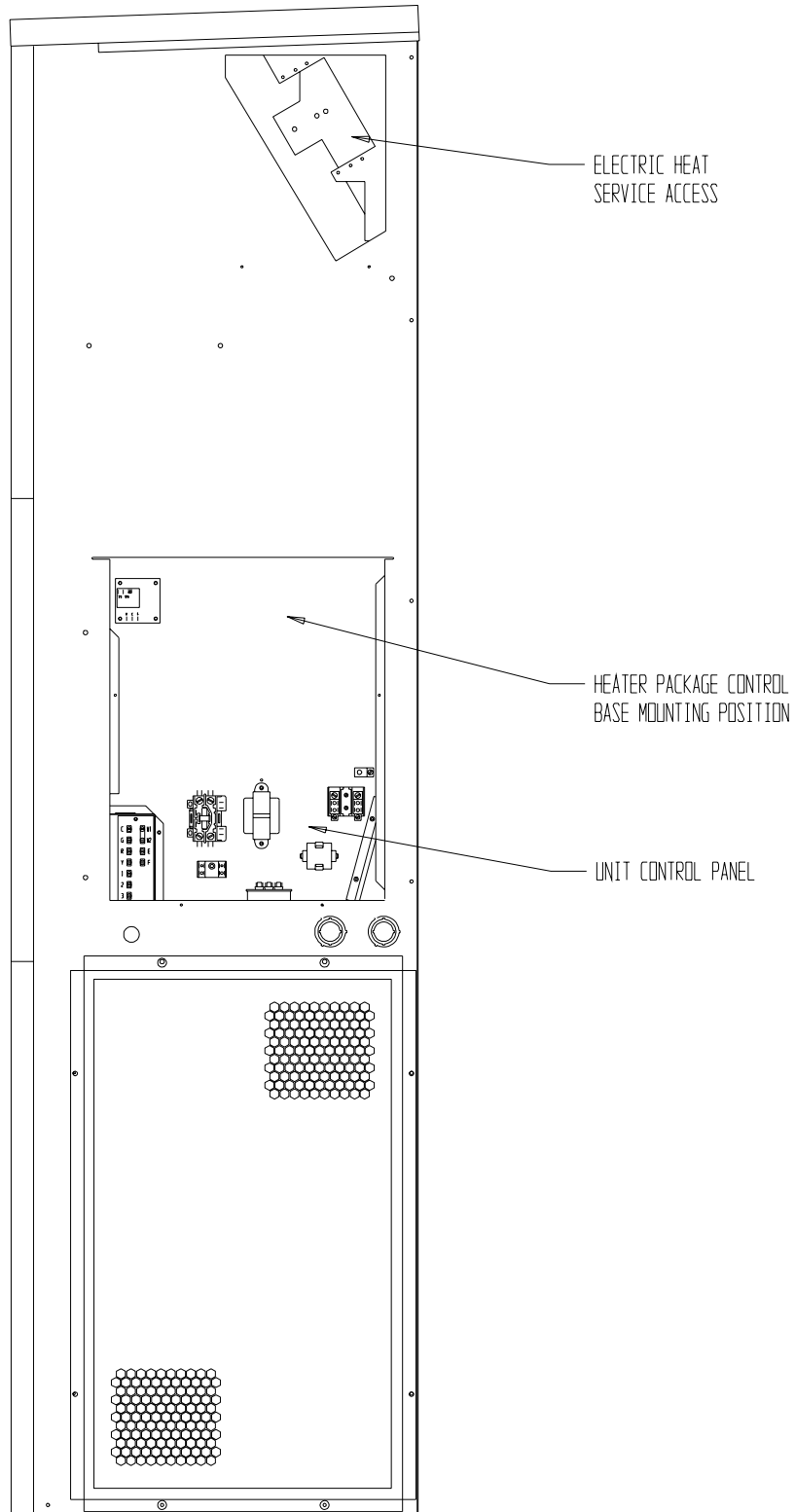

MIS-419

**TABLE 3
REFER TO FIGURES 3 AND 4**

	Heater Package Model Number	Figure 4 Heater Terminal Identification Drawing	Figure 3 Rod Support and Screw Mounting Position
1	EHWA02-AXD	4A	1
2	EHWA02-AXH	4B	1
3	EHWA05-AXH	4B	1 + 3
4	EHWA05-AXK	4C	1 + 3
5	EHWA03-AXH	4B	1 + 3
6	EHWA03-AXK	4D	1 + 3

**FIGURE 3
ROD SUPPORT AND SCREW MOUNTING POSITIONS**

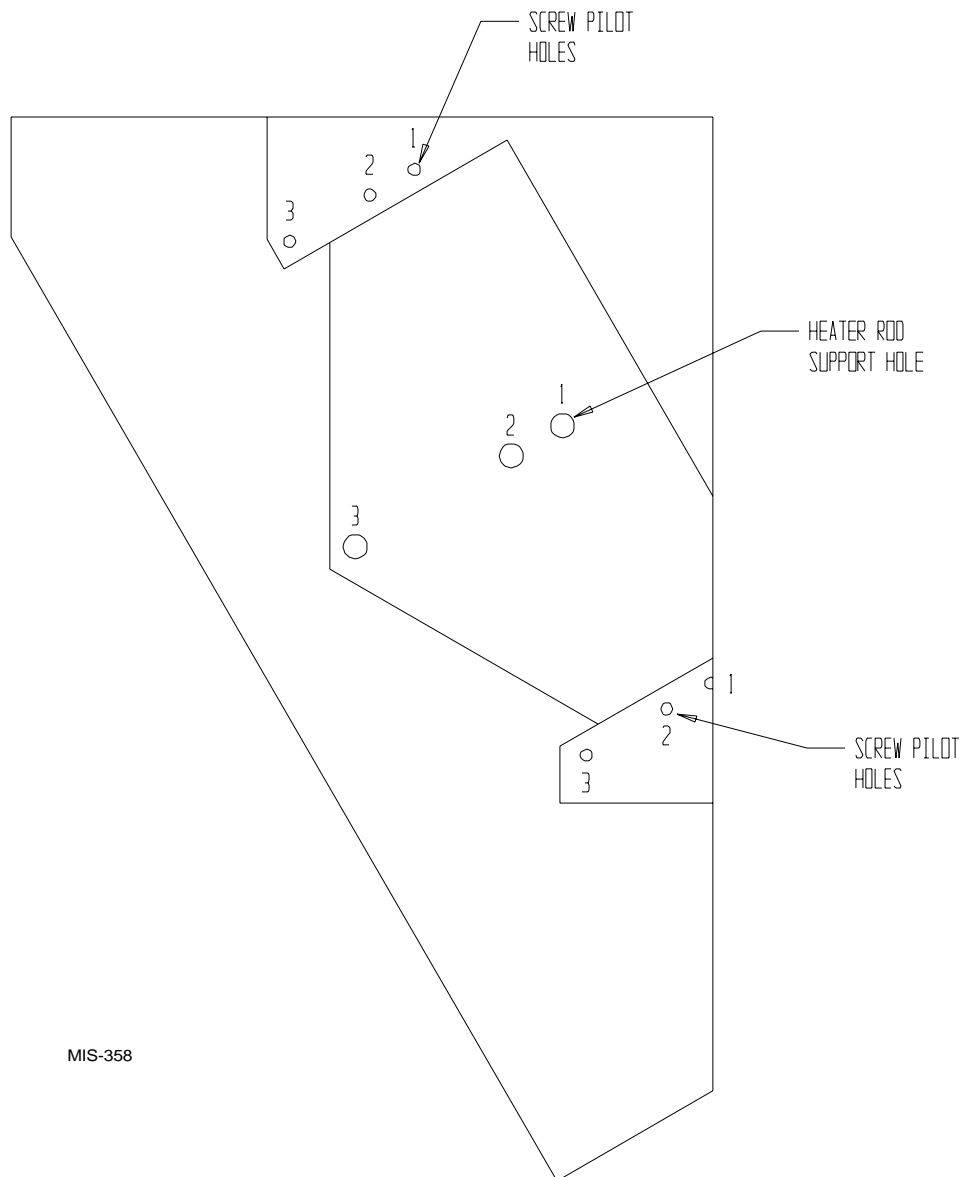

**FIGURES 4A - 4D
HEATER TERMINAL IDENTIFICATION DRAWINGS**

FIGURE 4A

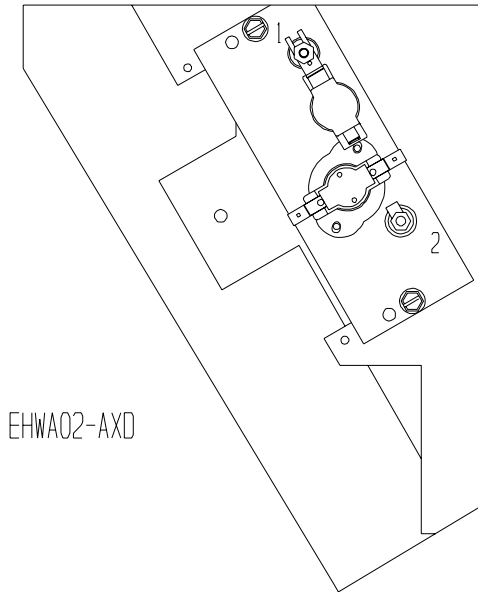

FIGURE 4C

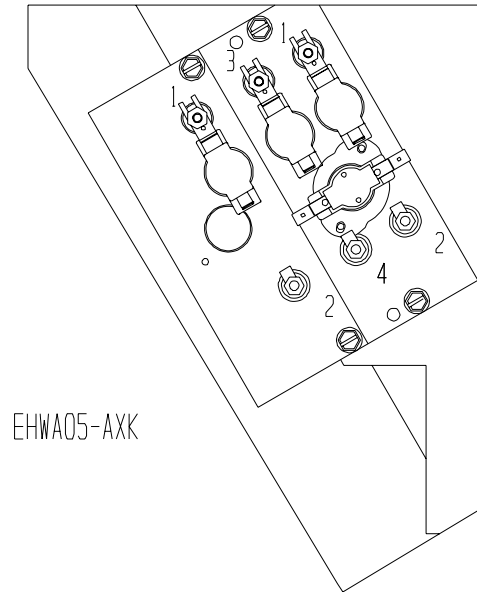

FIGURE 4B

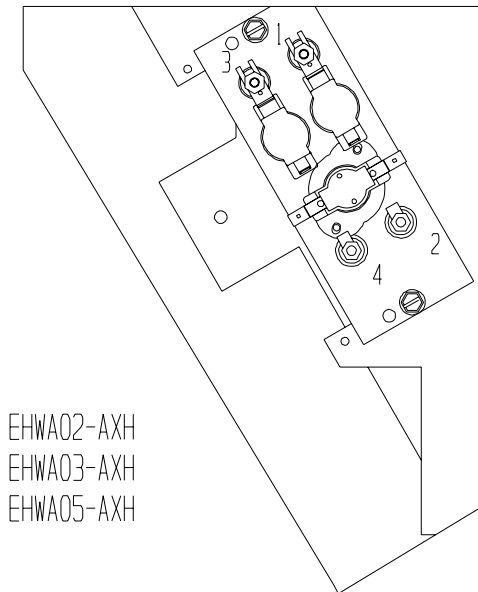
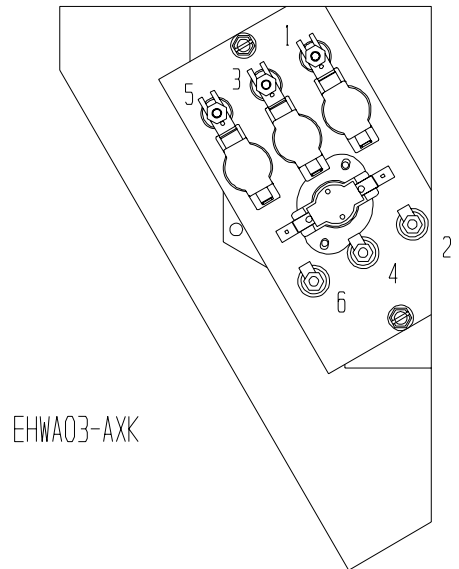

FIGURE 4D



NOTE: THERMAL CUTOFFS TO BE AT
TOP OF AIR FRAME WHEN INSTALLING.

MIS-1738

FIGURE 5
WIRING DIRECTIONS
WA24, WA30 AND WA36 MODELS

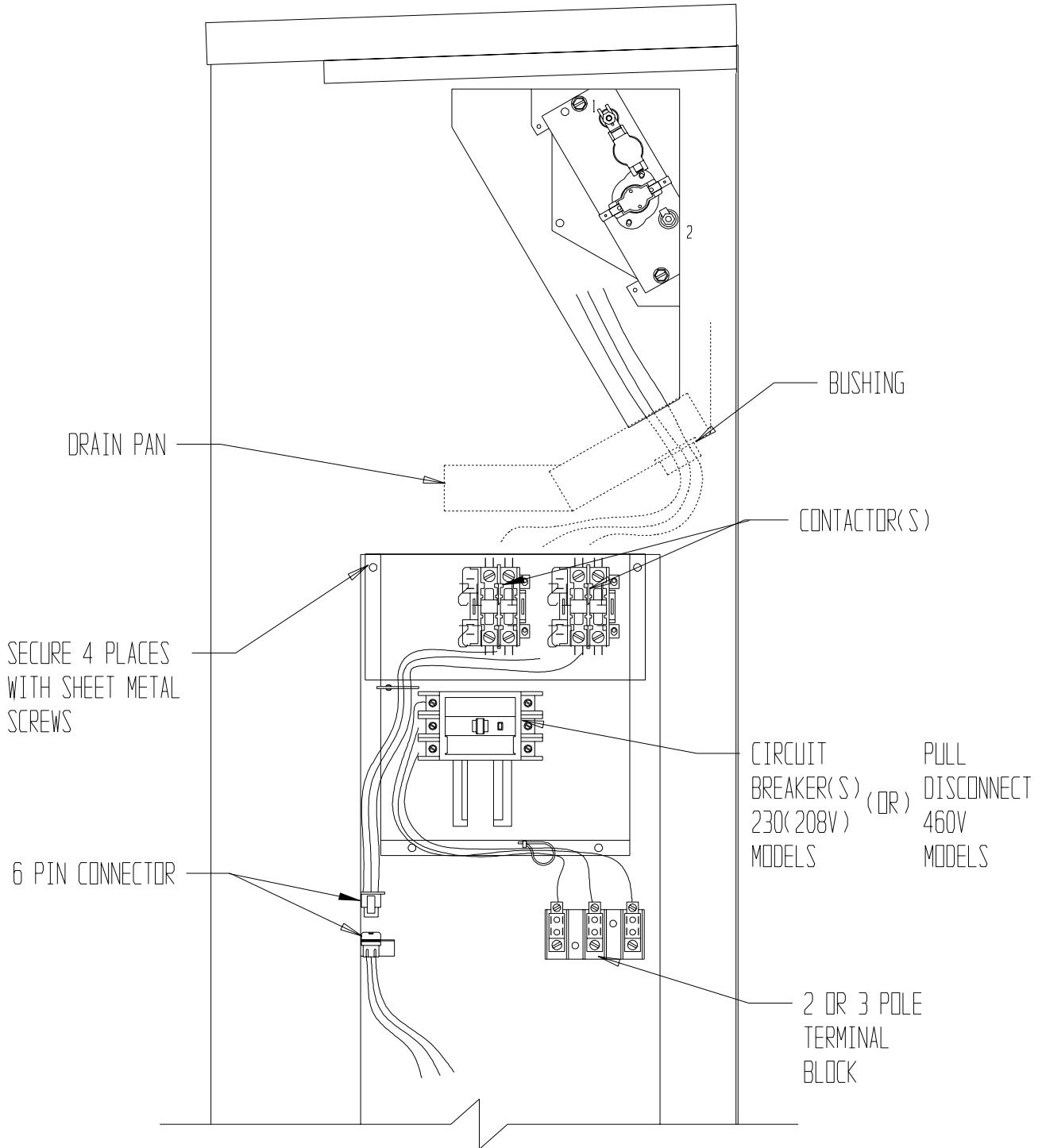

MIS-1741

**FIGURE 5A
WIRING DIRECTIONS
WA423, WA484 AND WA602 MODELS**

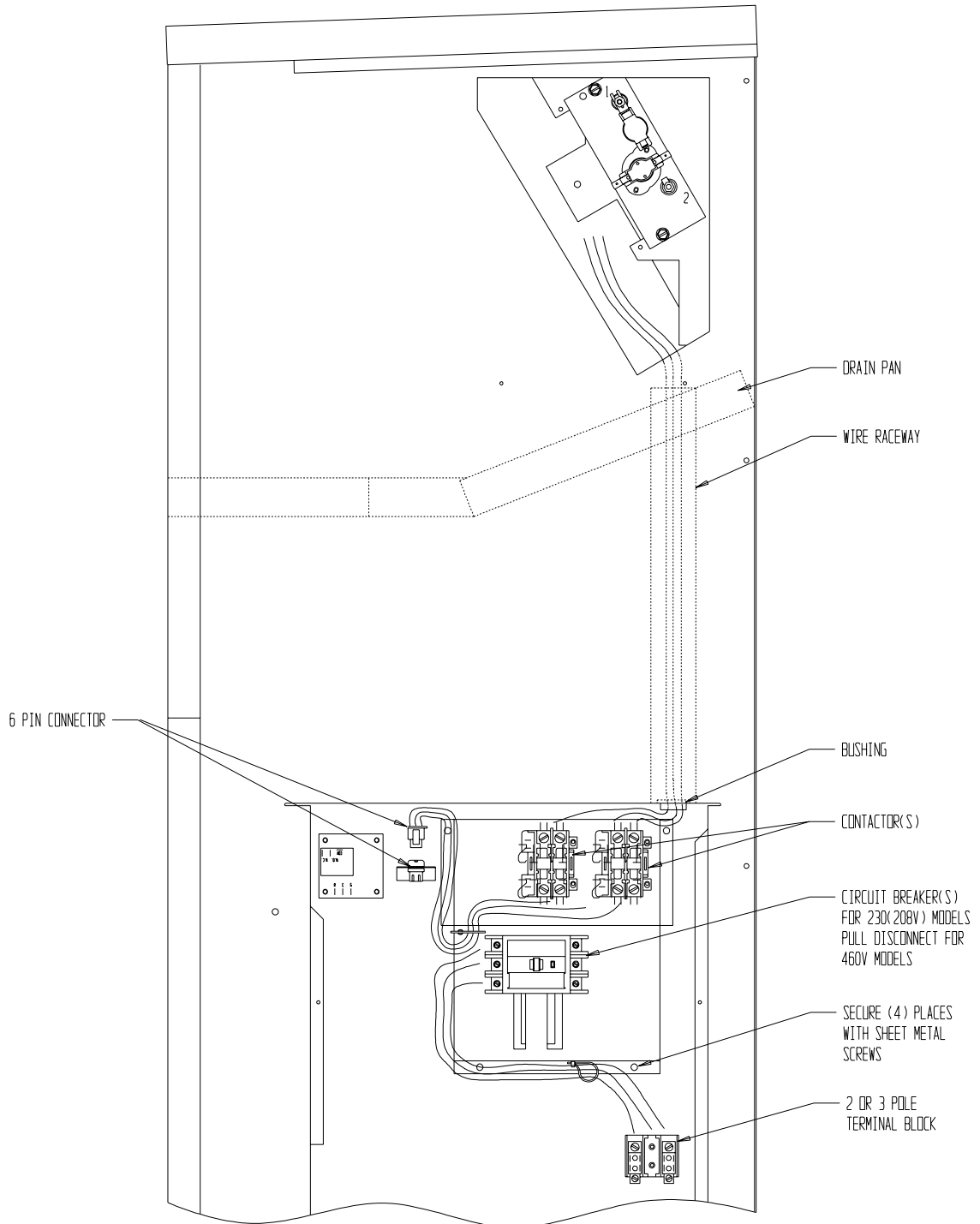

MIS-1742

**FIGURE 6
MARKING SERIAL PLATE LABEL**

(X)	()	()	()	()
()	(X)	()	()	()
()	()	(X)	()	()
()	()	()	(X)	()
()	()	()	()	(X)

ASSURE THAT SERIAL PLATE IS CLEAN AND DRY, REMOVE APPROPRIATE LABEL STRIP FOR KW REQUIRED AND REMARK SERIAL PLATE AS SHOWN FOR THE HEATER PACKAGE THAT IS INSTALLED

INSTALL ONLY HEATER PACKAGES LISTED HERE

APPLY NEW HEATER PACKAGE LABEL HERE

BARD MANUFACTURING COMPANY, 1914 RANDOLPH

(1)
APPROVED
HEATER
PACKAGE

MODEL	VAC	HZ
[()] WA361-A0012345	NONE	230/208 60
[()] WA361-A0512345	EHWA03-A05	230/208 60
[(X)] WA361-A0812345	EHWA03-A08	230/208 60
[()] WA361-AXH	EHWA03-AXH	230/208 60
[()] WA361-A XK	EHWA03-A XK	230/208 60

BRANCH CIRCUIT SELECT CURRENT 17 OPERATIO

SERIAL NUMBER 125H920711193-01 UL FILE NO.

SUITABLE FOR OUTDOOR USE

	VAC	HZ	PH	HP	KW
COMPRESSOR	230/208	60	1		
OUTDOOR MOTOR	230/208	60	1	1/5	
INDOOR MOTOR	230/208	60	1	1/3	
HEATER PACKAGE					
EHWA03-A05	240/208	60	1		5/3.75
EHWA03-A08	240/208	60	1		8/6
EHWA03-A10, -AXH	240/208	60	1		10/7.5
EHWA03-A15, -A XK	240/208	60	1		15/11.25

-- FACTORY

FACTORY CHARGED R22: 68 OZ. DESI

-- CLEAR