INSTALLATION INSTRUCTIONS

SINGLE PACKAGE AIR CONDITIONERS

MODELS

PA13242-A	PA13302-A
PA13362-A	PA13362-B
PA13422-A	PA13422-B
PA13422-C	PA13482-A
PA13482-B	PA13482-C
PA13602-A	PA13602-B
PA13602-C	



CLIMATE CONTROL SOLUTIONS

Bard Manufacturing Company, Inc.
Bryan, Ohio 43506
Since 1914 . . . Moving ahead just as planned.

Manual : 2100-467F
Supersedes: 2100-467E
File: Volume II Tab 10
Date: 05-28-09

CONTENTS

Getting Other Informations and Publications 3

General Instructions

Important 4
Shipping Damage 4
General 4
Field Installed Heater Packages (Optional) 4

Installation

Location 9
Slab Mounting 9
Typical Installations 9 & 12
Condensate Drain Trap 12
Air Filters 12
Wiring – Main Power 13
Wiring – 24V Low Voltage Control Circuit 13
Transformer Taps 13
Thermostats 13

Figures

Figure 1 Unit Dimensions 8
Figure 2 Slab Mounting at Ground Level 10
Figure 3 Airflow and Service Access
Clearances 10
Figure 4 Elevated Mounting Platform 11
Figure 5 Condensate Drain Trap 12
Figure 6 Low Voltage Wiring 14
Figure 7 Low Ambient Control Wiring 17
Figure 8 Fan Blade Setting 18
Figure 9 Brazing Diagram 21
Figure 10 Motor Connections 22
Figure 11 Wiring (Connections/Voltage) 23

Start Up and Operation

General 15
Topping Off System Charge 15
Safety Practices 15
Start Up Notes 15
Three Phase Scroll Compressor Start Up
Information 16
Sequence of Operation 16
Indoor Blower Motor 16
Compressor Control Module 16 & 17
Adjustments 17
Low Ambient Control 17

Service and Troubleshooting

Service Hints 18
Pressure Service Ports 18
Refrigerant Charge 18
Fan Blade Settings 18
Pressure Tables 19 & 20
Suction and Discharge Tube Brazing 21

Troubleshooting GE Blower Motors 22-23

Tables

Table 1 Rated CFM & ESP 4
Table 2 Electrical Specifications 5
Table 3 Opt. Field Installed Heater Packages 6
Table 4 Opt. Field Installed Elec. Heater 7
Table 5 Filter Requirements & Sizes 12
Table 6 Thermostat Wire Size 13
Table 7 Wall Thermostats 13
Table 8 Fan Blade Setting Dimensions 18
Table 9 Indoor Blower Performance 18
Table 10 Pressure Table 19
Table 11 Pressure Table 20

Getting Other Information and Publications

These publications can help you install the air conditioner or heat pump. You can usually find these at your local library or purchase them directly from the publisher. Be sure to consult current edition of each standard.

National Electrical Code ANSI/NFPA 70

Standard for the Installation ANSI/NFPA 90A
of Air Conditioning and Ventilating Systems

Standard for Warm Air ANSI/NFPA 90B
Heating and Air Conditioning Systems

Load Calculation for ACCA Manual J
Residential Winter and Summer Air Conditioning

Duct Design for Residential ACCA Manual D
Winter and Summer Air Conditioning and Equipment
Selection

FOR MORE INFORMATION, CONTACT THESE PUBLISHERS:

ACCA **Air Conditioning Contractors of America**
1712 New Hampshire Ave. N.W.
Washington, DC 20009
Telephone: (202) 483-9370
Fax: (202) 234-4721

ANSI **American National Standards Institute**
11 West Street, 13th Floor
New York, NY 10036
Telephone: (212) 642-4900
Fax: (212) 302-1286

ASHRAE **American Society of Heating, Refrigerating,
and Air Conditioning Engineers, Inc.**
1791 Tullie Circle, N.E.
Atlanta, GA 30329-2305
Telephone: (404) 636-8400
Fax: (404) 321-5478

NFPA **National Fire Protection Association**
Batterymarch Park
P.O. Box 9101
Quincy, MA 02269-9901
Telephone: (800) 344-3555
Fax: (617) 984-7057

GENERAL INSTRUCTIONS

IMPORTANT

The equipment covered in this manual is to be installed by trained, experienced service and installation technicians. All duct work, supply and return ducts, must be properly sized for the design airflow requirement of the equipment. ACCA is an excellent guide to proper sizing. All duct work or portions thereof not in the conditioned space should be properly insulated in order to both conserve energy and prevent condensation or moisture damage.

SHIPPING DAMAGE

Upon receipt of equipment, the carton should be checked for external signs of shipping damage. If damage is found, the receiving party must contact the last carrier immediately, preferably in writing, requesting inspection by the carrier's agent.

GENERAL

The refrigerant system is completely assembled and charged. All internal wiring is complete.

The unit is designed for use with or without duct work. Flanges are provided for attaching the supply and return ducts.

These instructions explain the recommended method to install the air cooled self-contained unit and the electrical wiring connections to the unit.

These instructions and any instructions packaged with any separate equipment required to make up the entire system should be carefully read before beginning the installation. Note particularly "Starting Procedure" and any tags and/or labels attached to the equipment.

While these instructions are intended as a general recommended guide, they do not supersede any national and/or local codes in any way. Authorities having jurisdiction should be consulted before the installation is made.

FIELD INSTALLED HEATER PACKAGES (OPTIONAL)

These packaged air conditioners are manufactured without supplementary electric heaters. Supplementary heaters are available for simple, fast field installation.

A separate power circuit is required for the supplementary heaters.

IMPORTANT: Refer to Table 1 when designing duct work for maximum available static pressure with heater installed.

Refer to data shown in Table 3 and 4 for proper application information on all available heater combinations and what units they can be used with. It also shows the applicable circuit ampacities, fuse size, and wire size for each heater combination.

**TABLE 1
RATED CFM AND EXTERNAL STATIC
PRESSURE (ESP)**

Model No.	Rated CFM	Recommended Airflow Range	Rated ESP	Max. ESP
PA1324	800	Note	0.18	0.50
PA1330	1000	Note	0.23	0.50
PA1336	1100	Note	0.23	0.50
PA1342	1450	Note	0.23	0.50
PA1348	1550	Note	0.28	0.50
PA1360	1750	Note	0.28	0.50

NOTE: ECM motors provide rated CFM up to 0.50 ESP

**TABLE 2
ELECTRICAL SPECIFICATIONS**

Model	PA13242-A	PA13302-A	PA13362-A	PA13362-B	PA13422-A	PA13422-B	PA13422-C	PA13482-A	PA13482-B	PA13482-C	PA13602-A	PA13602-B	PA13602-C
Electric Rating – 60 Hz – Circuit A	230/208-60-1	230/208-60-1	230/208-60-1	230/208-60-3	230/208-60-1	230/208-60-3	460-60-3	230/208-60-1	230/208-60-3	460-60-3	230/208-60-1	230/208-60-3	460-60-3
Operating Voltage Range	197 - 253	197 - 253	197 - 253	187 - 253	197 - 253	187 - 253	414-506	197 - 253	187 - 253	414-506	197 - 253	187 - 253	414-506
Minimum Circuit-Ampacity	15	18	24	16	33	23	12	33	29	14	39	26	17
BCSC	9	11	15	10	21	15	8	22	14	8	26	16	9
Field Wire Size *	12	10	8	12	10	10	14	8	10	12	8	10	10
Ground Wire Size	12	10	8	12	10	10	14	8	10	14	8	10	12
Delay Fuse – Max. **	20	25	35	20	50	35	15	50	40	20	60	40	25
Total unit Amps – 230/208	10.8/11.8	13.3/14.8	16.4/18.4	17.0/13.3	16.2/18.1	14.1/15.4	10.4	23.0/24.7	16.9/18.0	10.7	25.3/28.9	17.7/19.9	11.9
Compressor – Circuit A													
Compressor Type	Recip.	Recip.	Recip.	Recip.	Scroll	Scroll	Scroll	Scroll	Scroll	Scroll	Scroll	Scroll	Scroll
Volts	230/208	230/208	230/208	230/208	230/208	230/208	460	230/208	230/208	460	230/208	230/208	460
Rated Load Amps	7.5/8.5	9.5/11	12/14	7.6/8.9	11.8/13.7	8.3/9.6	7.7	17/18.7	10.9/12	7.7	19.3/22.9	11.7/13.9	8.6
Lock Rotor Amps	48/48	57/57	74/74	75/75	115/115	115/115	50	117/117	83.1/83.1	50	134/134	110/110	52
Fan Motor and Condenser													
Fan Motor – HP/RPM	1/6 - 825	1/6 - 825	1/6 - 825	1/6 - 825	1/4 - 825	1/4 - 825	1/4 - 825	1/4 - 825	1/4 - 825	1/4 - 825	1/4 - 825	1/4 - 825	1/4 - 825
Fan Motor Amps	1.1	1.1	1.1	1.1	1.5	1.5	1.5	1.5	1.5	1.5	1.5	1.5	1.5
Fan – Dia./CFM	24"/2700	24"/2600	24"/2600	24"/2600	24"/3400	24"/3400	24"/3400	24"/3400	24"/3400	24"/3400	24"/3400	24"/3400	24"/3400
Motor and Evaporator													
Blower Motor – HP/RPM	1/3 - ECM	1/2 - ECM	1/2 - ECM	1/2 - ECM	1/2 - ECM	1/2 - ECM	1/2 - ECM	3/4 - ECM	3/4 - ECM	3/4 - ECM	3/4 - ECM	3/4 - ECM	3/4 - ECM
Blower Motor – Amps	2.2	2.7	3.3	3.3	3.9	3.9	3.9	4.5	4.5	4.5	5.0	5.0	5.0
CFM Cooling	800	1000	1150	1150	1450	1450	1450	1550	1550	1550	1750	1750	1750
Charge (R-410 oz.)	75	85	120	120	160	160	160	160	160	160	160	160	160
Shipping Weight (pounds)	360	410	410	410	440	440	490	440	440	500	450	450	500

**TABLE 3
OPTIONAL FIELD INSTALLED HEATER PACKAGES
ONLY TO BE USED WITH THE MODELS INDICATED**

Heater Package Model	Volts & Phase	PA13242-A	PA13302-A	PA13362-A	PA13362-B	PA13422-A	PA13422-B	PA13422-C	PA13482-A	PA13482-B	PA13482-C	PA13602-A	PA13602-B	PA13602-C
EHP323-A05	240/208-1	X	X	X										
EHP323-A10	240/208-1	X	X	X										
EHP323-A15	240/208-1		X	X										
EHP323-B09	240/208-3				X									
EHP323-B15	240/208-3				X									
EHP513-A05	240/208-1					X			X			X		
EHP513-A10	240/208-1					X			X			X		
EHP513-A15	240/208-1					X			X			X		
EHP513-B09	240/208-3						X			X			X	
EHP513-B15	240/208-3						X			X			X	
EHP513-C09	460-3							X						X
EHP513-C15	460-3							X						X

**TABLE 4
OPTIONAL FIELD INSTALLED ELECTRIC HEATER TABLE**

Heater Package Model No.	Unit Volts Phases	Htr. KW & Capacity @ 240 Volts		Htr. KW & Capacity @ 208 Volts		240/208V Htr. Amps	Heater Internal Circuit Breaker	Circuit B				
		KW	BTUH	KW	BTUH			No. Field Circuits	③ Min. Circuit Ampacity	① Max. Over Current Protection	② Field Power Wiring	② Ground Wire Size
EHP323-A05	240/208-1	5	17,100	3.75	12,800	20.8/18.1		1	26/23	30/25	10/10	10
EHP323-A10	240/208-1	10	34,100	7.50	26,000	41.6/36.2	30/60	1	53/46	60/50	6/8	10
EHP323-A15	240/208-1	15	51,200	11.25	38,400	62.5/54.1		1	79/68	80/70	4/4	8
EHP513-A05	240/208-1	5	17,100	3.75	12,800	20.8/18.1		1	26/23	30/25	10/10	10
EHP513-A10	240/208-1	10	34,100	7.50	26,000	41.6/36.2	30/60	1	53/46	60/50	6/8	10
EHP513-A15	240/208-1	15	51,200	11.25	38,400	62.5/54.1		1	79/68	80/70	4/4	8
EHP323-B09	240/208-3	9	30,700	6.75	23,000	21.7/18.7		1	28/24	30/25	10/10	10
EHP323-B15	240/208-3	15	51,200	11.25	38,400	36.2/31.2	None	1	46/39	50/40	8/8	10
EHP513-B09	240/208-3	9	30,700	6.75	23,000	21.7/18.7		1	28/24	30/25	10/10	10
EHP513-B15	240/208-3	15	51,200	11.25	38,400	36.2/31.2	None	1	46/39	50/40	8/8	10
EHP513-C09	480-3	9	30,700			10.8	None	1	14	15	14	14
EHP513-C15	480-3	15	51,200			18		1	28	30	10	12

① Maximum size of the time delay fuse or HACR circuit breaker for protection of field wiring devices.

② Based on wire suitable for 75°C. Other wiring materials must be rated for marked "Minimum Circuit Ampacity" or greater. Based on 75°C copper wire. All wiring must conform to the National Electric Code and all local codes.

③ These "Minimum Circuit Ampacity" values are to be used for sizing the field power conductors. Refer to the National Electric Code (latest revision), Article 310 for power conductor sizing.

IMPORTANT: While this electrical data is presented as a guide, it is important to electrically connect properly sized fuses and conductor wires in accordance with the National Electrical Code and all existing local codes.

**FIGURE 1
DIMENSIONS OF UNITS**

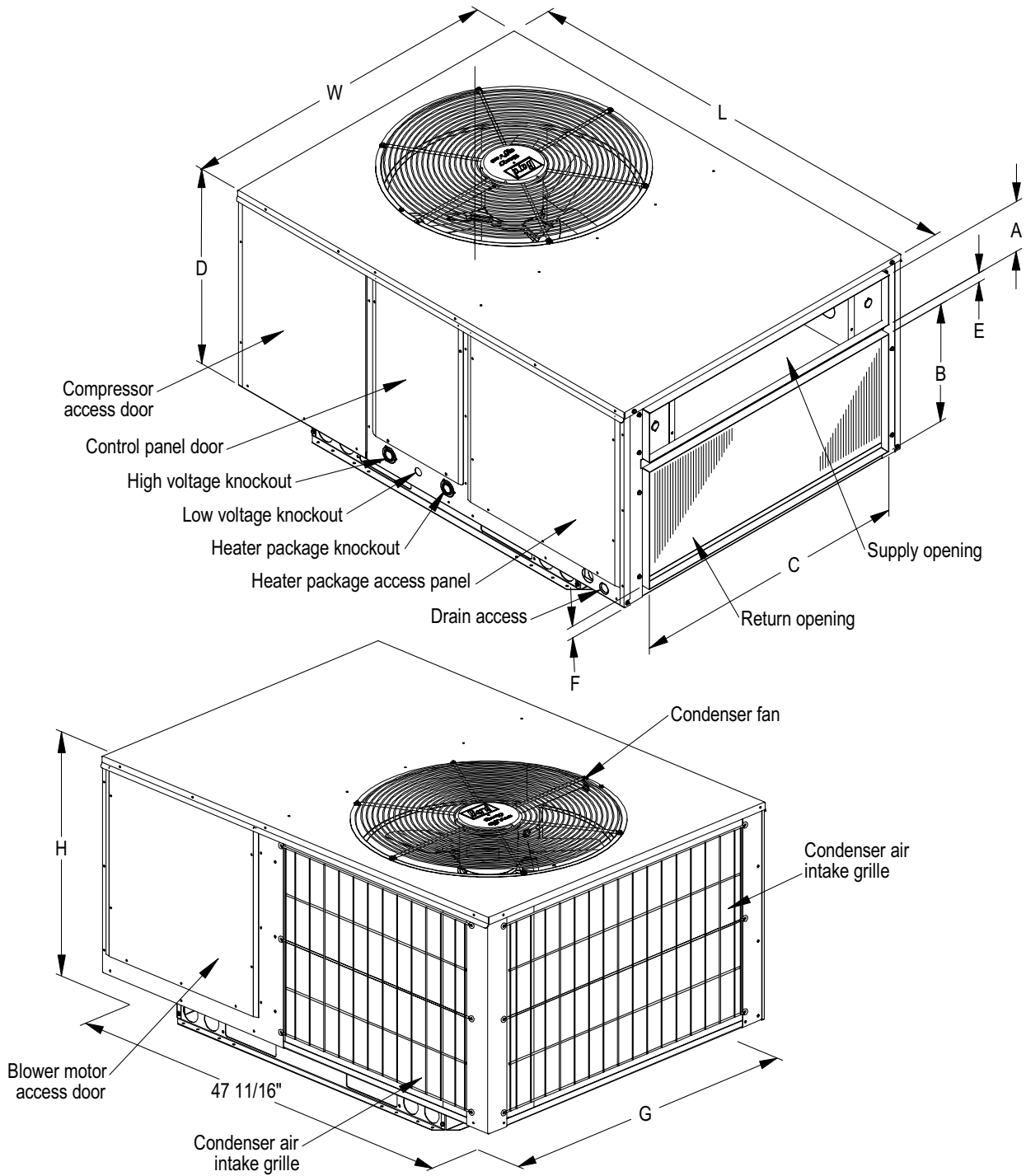

Unit Dimension Chart

Unit	Supply Size		Return Size		Unit Overall Dimensions			Unit General Dimensions			
	A	C	B	C	H (height)	L (length)	W (width)	D	E	F	G
PA/PH1324, 1330, 1336	5.875	32.875	13.875	32.875	26.25	53.25	38.125	23.25	1.125	1.375	35.625
PA/PH1342, 1348, 1360	9.875	37.875	15.875	37.875	33.25	55.25	42.375	30.25	1.5	2.375	38.125

MIS-2142 A

LOCATION

GENERAL

The unit must be located outside, or in a well ventilated area. It must not be in the space being heated or cooled. A sound absorbing material should be considered if the unit is to be installed in such a position or location that might cause transmission of sound or vibration to the living area or adjacent buildings.

SLAB MOUNTING

A minimum of 24 inches should be provided between the coil inlet and any building surfaces. Provide a minimum of three feet clearance on the service access side of the unit. See Figure 2.

TYPICAL INSTALLATIONS

1. **ROOF MOUNTED** – The unit is mounted on a sturdy base on the roof of the building. Return air to the unit is brought through a single return grille (grilles with built-in filters are best since they enable easy access for filter changing). Return air ducts are attached to the lower section of the front panel. Supply air is brought from the unit to attic duct work or to a furred down hall. Supply air duct is attached to the top of the front panel.

CAUTION: All outdoor duct work must be thoroughly insulated and weatherproofed. All attic duct work must be thoroughly insulated. Two inch thick insulation with suitable vapor barrier is recommended for both outdoor and attic runs.

In roof top installation, as in all installations, the air conditioner must be level from side to side. However, the unit should have a pitch along the length to assure complete external drainage of precipitation and of defrost condensate.

2. **CRAWL SPACE** – Duct work installed in crawl space must be well insulated and provided with a vapor barrier. In addition, the crawl space must be thoroughly ventilated and provided with a good vapor barrier as a ground cover. It is most desirable to install the unit will be outdoors rather than inside the crawl space, so that it will be readily accessible for service.
3. **SLAB MOUNTED AT GROUND LEVEL** – This type installation is ideal for homes with a slab floor construction where a roof mounted unit is not desired. The supply and return duct work can be run through a furred closet space.
4. **THROUGH THE WALL** – This type installation requires a suitable framework to be fabricated capable of withstanding the unit weight. Normally the unit will be insulated so as to minimize supply and return duct work.

**FIGURE 2
SLAB MOUNTING AT GROUND LEVEL**

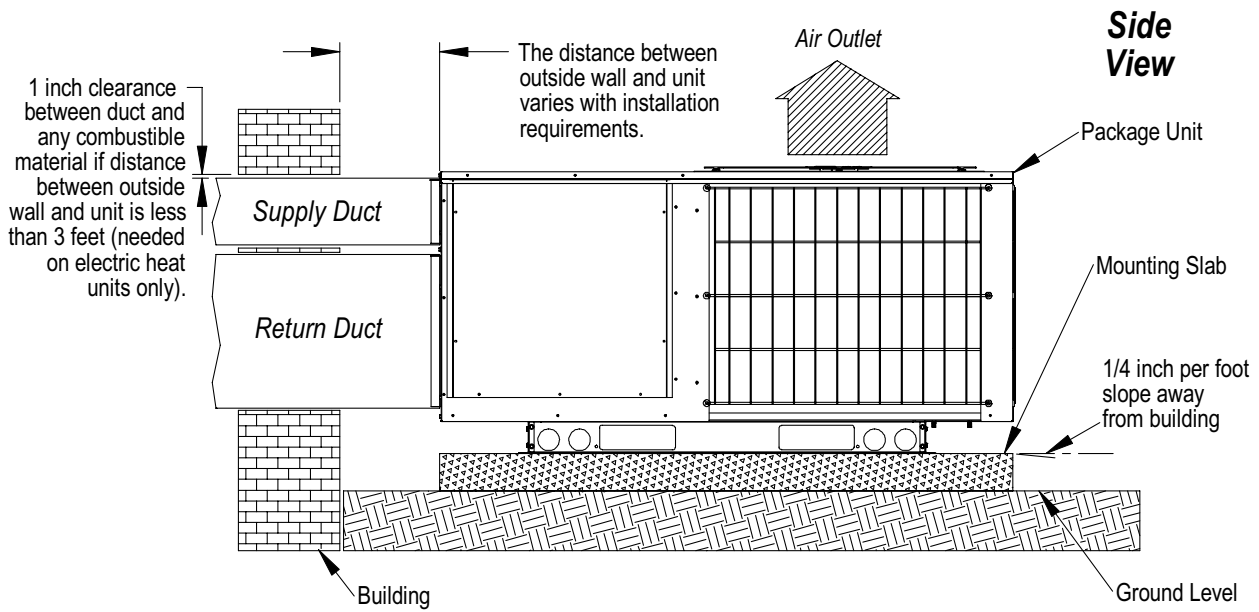

**FIGURE 3
AIRFLOW AND SERVICE ACCESS CLEARANCES**

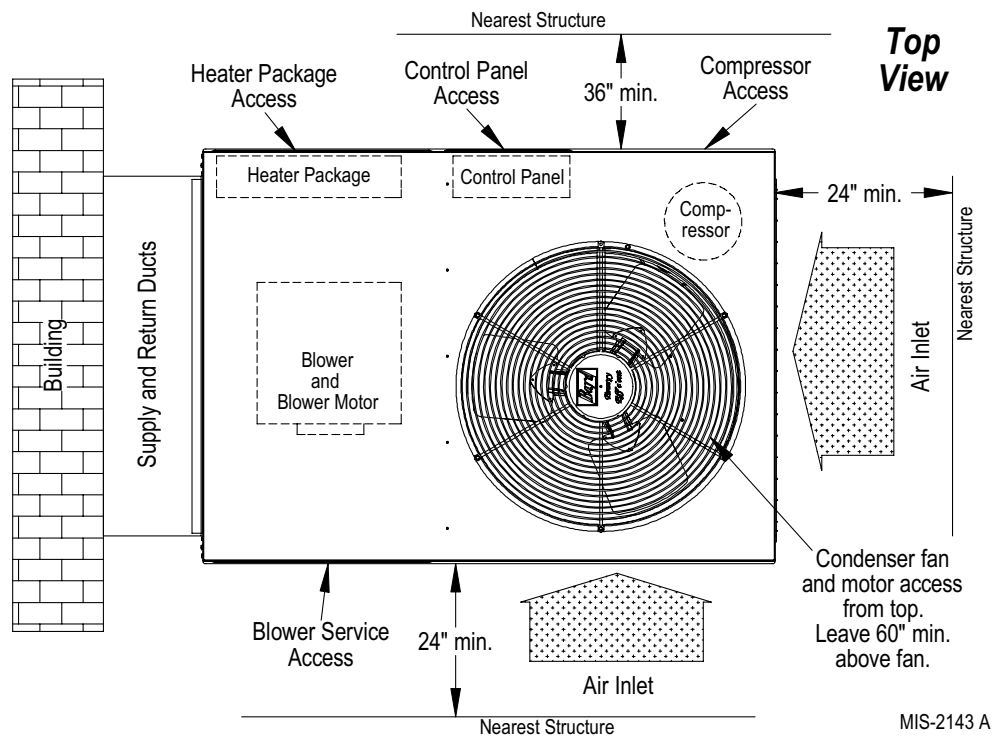

**FIGURE 4
ELEVATED MOUNTING PLATFORM**

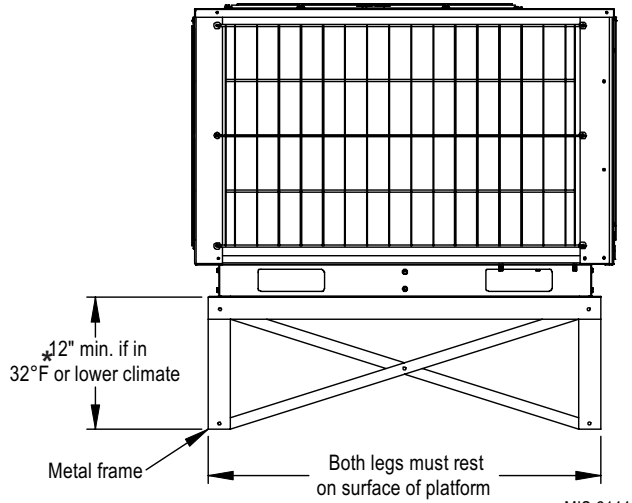
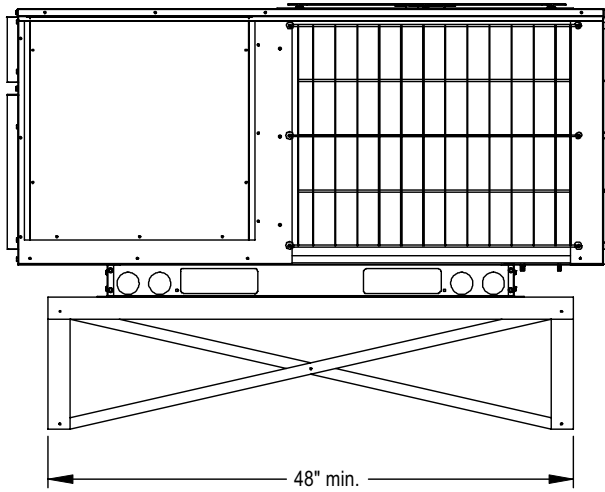
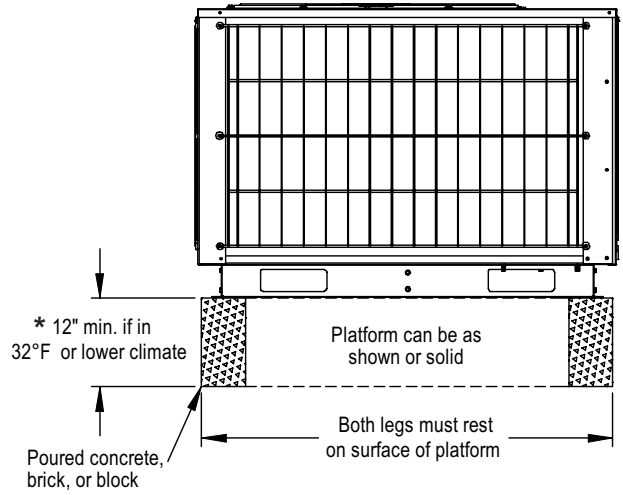
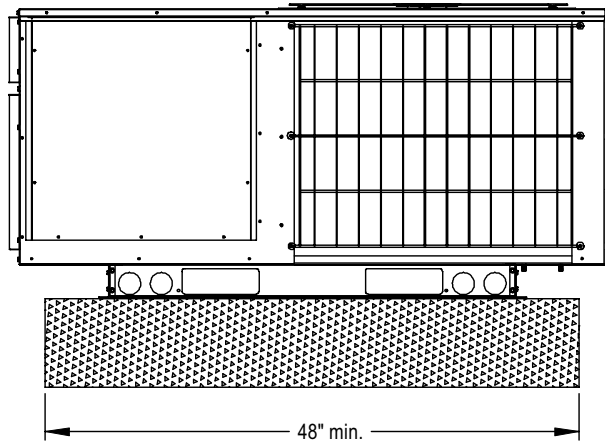

MIS-2144 A

* AS REQUIRED

5. **OTHER INSTALLATIONS** – Many other installations are possible with the packaged air conditioner. No matter what the installation, always consider the following facts:

- A. Insure that the discharge air is not obstructed in any way so as to cause operation difficulties.
- B. The indoor coil drain pan is equipped with a coupling that must be piped through a condensate drain trap to a suitable drain.
- C. Always mount the unit in such a position that it may be easily reached for servicing and maintenance.
- D. Insure that the unit is clear so that proper air flow over the outdoor coil will be maintained.

If this unit is operated in cooling below a 55° outdoor ambient temperature, the installation of low ambient controls (CMA-28) to unit is required.

CONDENSATE DRAIN TRAP

It is very important to provide a trap in the condensate drain line to allow a positive liquid seal in the line and assure correct drainage from the coil condensate pan.

Install condensate drain trap shown in Figure 8. Use drain connection size or larger. Do not operate unit without trap. Unit must be level or slightly inclined toward drain. With a trap installed on a unit located in an unconditioned area, water in the trap may freeze. It is recommended that the trap material be of a type that will allow for expansion of water when it freezes.

AIR FILTERS

Air filters for the return air side of the system are not provided as part of these models, and must be field supplied and installed as part of the final installation.

Prior thought should be given to return air location and placement of the air filter(s). The air filter(s) must be of adequate size and readily accessible to the operator of the equipment. Filters must be adequate in size and properly maintained for proper operation. If this is not done, excessive energy use, poor performance, and multiple service problems will result. *It is impossible to oversize air filters.* Generous sizing will result in cleaner air and coils as well as lower operating costs and extend the time between required changes. Table 5 shows minimum filter areas and recommended filter sizes. Actual filter sizes can vary with the installation due to single or multiple returns utilizing a filter/grille arrangement or being placed immediately ahead of the indoor coil face in the return air duct.

**TABLE 5
FILTER REQUIREMENTS & SIZES**

Model No.	Minimum Filter Free Area	Minimum Recommended Size
PA1324 PA1330 PA1336	403 Square Inches (2.8 Square Feet)	(2) 14 x 20 x 1
PA1342 PA1348 PA1360	473 Square Inches (3.3 Square Feet)	(2) 16 x 20 x 1

NOTE: If roof hood accessory is to be used, information on air filters may be found under that heading in this manual. Air filters are supplied as part of that package.

**FIGURE 5
CONDENSATE DRAIN TRAP**

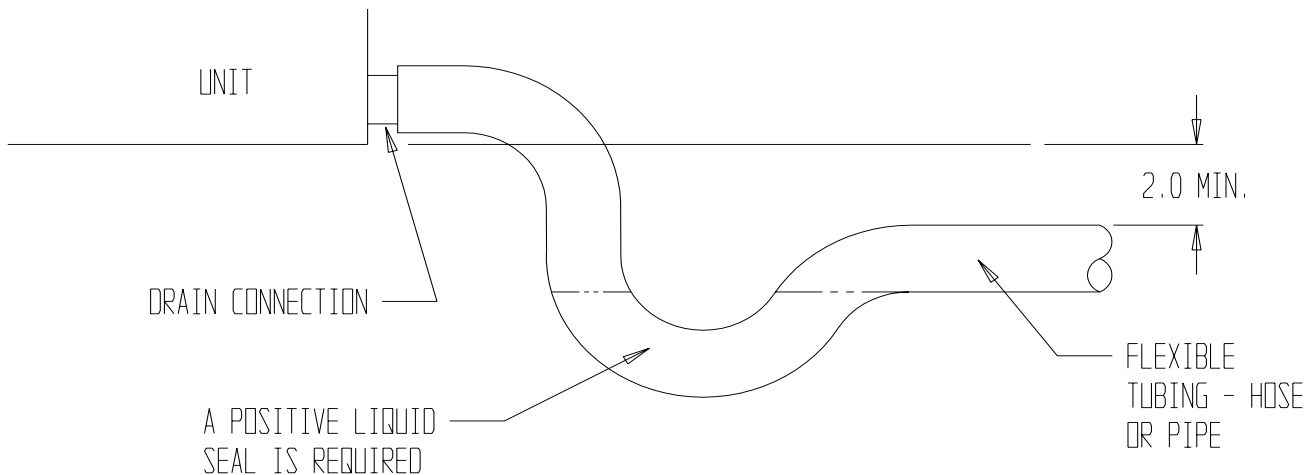

MIS-136

WIRING – MAIN POWER

Refer to the unit rating plate for wire sizing information and maximum fuse size. Each outdoor unit is marked with a “Minimum Circuit Ampacity”. This means that the field wiring used must be sized to carry that amount of current. If field installed heaters are added to the basic unit, a second separate power supply circuit will be required. The heater rating plate located adjacent to the basic unit rating plate will show the appropriate circuit ampacity fuse size, etc. (Also see “Electrical Specifications” on pages 5 & 7.) *All models are suitable for connection with copper wire only.* These instructions **must** be adhered to. Refer to the National Electrical Code for complete current carrying capacity data on the various insulation grades of wiring material.

The electrical specifications list fuse and wire sizes (75°F copper) for all models including the most commonly used heater sizes.

The unit rating plate lists a “Maximum Time Delay Fuse” or “HACR” type circuit breaker that is to be used with the equipment. The correct size must be used for proper circuit protection and also to assure that there will be no nuisance tripping due to the momentary high starting current of the compressor.

WIRING – 24V LOW VOLTAGE CONTROL CIRCUIT

Five (5) wires should be run from thermostat subbase to the 24V terminal board in the unit. A five conductor, 18 gauge copper, color-coded thermostat cable is recommended. The connection points are shown in Figure 6.

**TABLE 6
THERMOSTAT WIRE SIZE**

Transformer VA	FLA	Wire Gauge	Maximum Distance In Feet
55	2.3	20	45
		18	60
		16	100
		14	160
		12	250

TRANSFORMER TAPS

230/208V, 1 phase and 3 phase equipment employ dual primary voltage transformers. All equipment leaves the factory wired on 240V tap. For 208V operation, reconnect from 240V to 208V tap. The acceptable operating voltage range for the 240 and 208V taps are:

TAP	RANGE
240	253 – 216
208	220 – 187

NOTE: The voltage should be measured at the field power connection point in the unit and while the unit is operating at full load (maximum amperage operating condition).

THERMOSTATS

See specific wiring information for the different models, heater KWs, and voltages on unit and heating wiring diagrams.

**TABLE 7
WALL THERMOSTATS**

Thermostat	Predominant Features
8403-057 (TH3110D1040)	1 stage Cool; 1 stage Heat heat-off-cool Fan: on-auto Electronic Non-Programmable
8403-058 (TH5220D1151)	2 stage Cool; 2 stage Heat Electronic Non-Programmable Auto or Manual changeover
8403-060 (1120-445)	3 stage Cool; 3 stage Heat Programmable/Non-Programmable Electronic HP or Conventional Auto or Manual changeover

IMPORTANT NOTE: *Only the thermostats as shown above will work with this equipment. The thermostats and correct operation can be assured only by proper selection and application of these parts.*

**FIGURE 6
LOW VOLTAGE WIRING**

Low Voltage Wiring

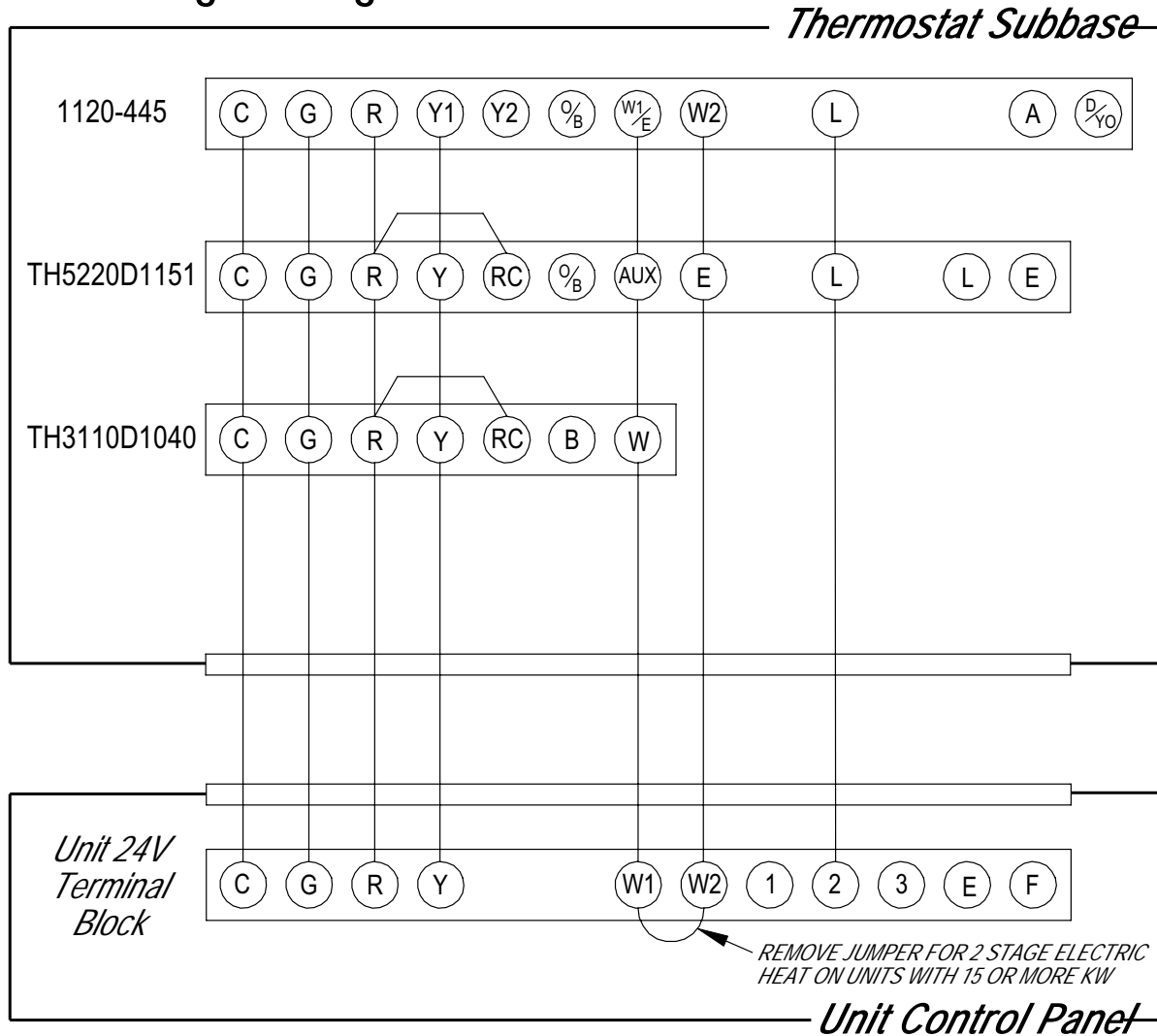

MIS-2149 B

These units require R-410A refrigerant and Polyol Ester oil.

GENERAL:

1. Use separate service equipment to avoid cross contamination of oil and refrigerants.
2. Use recovery equipment rated for R-410A refrigerant.
3. Use manifold gauges rated for R-410A (800 psi/250 psi low).
4. R-410A is a binary blend of HFC-32 and HFC-125.
5. R-410A is nearly azeotropic - similar to R-22 and R-12. Although nearly azeotropic, charge with liquid refrigerant.
6. R-410A operates at 40-70% higher pressure than R-22, and systems designed for R-22 cannot withstand this higher pressure.
7. R-410A has an ozone depletion potential of zero, but must be reclaimed due to its global warming potential.
8. R-410A compressors use Polyol Ester oil.
9. Polyol Ester oil is hygroscopic; it will rapidly absorb moisture and strongly hold this moisture in the oil.
10. A liquid line dryer must be used - even a deep vacuum will not separate moisture from the oil.
11. Limit atmospheric exposure to 15 minutes.
12. If compressor removal is necessary, always plug compressor immediately after removal. Purge with small amount of nitrogen when inserting plugs.

TOPPING OFF SYSTEM CHARGE

If a leak has occurred in the system, Bard Manufacturing recommends reclaiming, evacuating (see criteria above), and charging to the nameplate charge. Topping off the system charge can be done without problems.

With R-410A, there are no significant changes in the refrigerant composition during multiple leaks and recharges. R-410A refrigerant is close to being an azeotropic blend (it behaves like a pure compound or single component refrigerant). The remaining refrigerant charge, in the system, may be used after leaks have occurred and then “top-off” the charge by utilizing the charging charts on the inner control panel cover as a guideline.

REMEMBER: When adding R-410A refrigerant, it must come out of the charging cylinder/tank as a liquid to avoid any fractionation, and to insure optimal system

performance. Refer to instructions for the cylinder that is being utilized for proper method of liquid extraction.

SAFETY PRACTICES:

1. Never mix R-410A with other refrigerants.
2. Use gloves and safety glasses, Polyol Ester oils can be irritating to the skin, and liquid refrigerant will freeze the skin.
3. Never use air and R-410A to leak check; the mixture may become flammable.
4. Do not inhale R-410A – the vapor attacks the nervous system, creating dizziness, loss of coordination and slurred speech. Cardiac irregularities, unconsciousness and ultimate death can result from breathing this concentration.
5. Do not burn R-410A. This decomposition produces hazardous vapors. Evacuate the area if exposed.
6. Use only cylinders rated DOT4BA/4BW 400.
7. Never fill cylinders over 80% of total capacity.
8. Store cylinders in a cool area, out of direct sunlight.
9. Never heat cylinders above 125°F.
10. Never trap liquid R-410A in manifold sets, gauge lines or cylinders. R-410A expands significantly at warmer temperatures. Once a cylinder or line is full of liquid, any further rise in temperature will cause it to burst.

START UP NOTES

For improved start up performance, wash the indoor coil with dishwasher detergent.

START UP AND OPERATION

THREE PHASE SCROLL COMPRESSOR START UP INFORMATION

(Models PA13362-B; PA13422-B, -C; PA13482-B, -C; PA13602-B, -C)

All units with three phase scroll compressors are equipped with a three phase line monitor to prevent compressor damage due to phase reversal.

The phase monitor in this unit is equipped with two LED's. If the "Y" signal is present at the phase monitor and phases are correct, the green LED will light.

If phases are reversed, the red fault LED will be lit and compressor operation is inhibited.

If a fault condition occurs, reverse tow of the supply leads to the unit. Do not reverse any of the unit factory wires as damage may occur.

SEQUENCE OF OPERATION

BLOWER ONLY – When the "Fan" switch on the room thermostat is placed in the "On" position (circuit R-G makes), the blower will energize and run until the "Fan" switch is placed back into the "Auto" position. This will allow for constant air circulation at a lower airflow during times when the unit is not in operation for cooling or heating.

COOLING – On a call for cooling from the room thermostat (circuit R-Y makes), the blower will energize (circuit R-G is automatic when R-Y makes) as well as the compressor, and outdoor fan motor. Note that if the "Fan" switch on the room thermostat is in the "On" position and the blower is already in operation, then the motor will ramp up to the required speed for cooling.

HEATING (1st Stage) – On a call for heating from the room thermostat (circuit R-W1 makes), the blower will energize (circuit R-G is automatic when R-W1 makes). This will place the system into heating operation to maintain the thermostat set temperature. Note that if the "Fan" switch on the room thermostat is in the "On" position and the blower is already in operation, then the motor will ramp up to the required speed for heating.

HEATING (2nd Stage) – If the operation of the 1st Stage electric heaters will not maintain the set room temperature, then the thermostat will call for additional heat to help maintain the set temperature. On a call for second stage heating from the room thermostat (circuit R-W2 makes), additional electric heaters will be energized if installed.

INDOOR BLOWER MOTOR

These models feature a variable speed (ECM) motor providing high efficiency, low sound levels and soft start capabilities. The motor is self adjusting to provide the proper airflow rate at duct static pressures up to 0.50" WC without user adjustment or wiring changes.

On command from the wall thermostat the motor will start slowly and ramp up to full speed over a period of 10-15 seconds.

When the thermostat is satisfied the blower will operate for approximately 1 minute, and then slow down and stop.

COMPRESSOR CONTROL MODULE

The compressor control is an anti-short cycle/lockout timer with high and low pressure switch monitoring and alarm output.

ADJUSTABLE DELAY-ON-MAKE AND BREAK TIMER

On a call for compressor operation the *delay-on-make* period begins which will be 10% of the *delay-on-break* setting. When the delay-on-make is complete and the high pressure switch (and low pressure switch if employed) is closed, the compressor contactor is energized. Upon shutdown, the delay-on-break timer starts and prevents restart until the delay-on-break and delay-on-make periods have expired.

HIGH PRESSURE SWITCH AND LOCKOUT SEQUENCE (Standard Feature)

If the high pressure switch opens, the compressor contactor will de-energize immediately. The lockout timer will go into a *soft lockout* and stay in soft lockout until the high pressure switch closes **and** the delay-on-make time has expired. If the high pressure switch opens again in this same operating cycle the unit will go into *manual lockout* condition and the alarm circuit will energize. Recycling the wall thermostat resets the manual lockout.

LOW PRESSURE SWITCH, BYPASS, AND LOCKOUT SEQUENCE (Standard Feature)

If the low pressure switch opens for more than 120 seconds, the compressor contactor will de-energize and go into a soft lockout. Regardless the state of the low pressure switch, the contactor will reenergize after the delay-on-make time delay has expired. If the low pressure switch remains open or opens again for longer than 120 seconds the unit will go into manual lockout condition and the alarm circuit will energize. Recycling the wall thermostat resets the manual lockout.

ALARM OUTPUT

Alarm terminal is output connection for applications where alarm signal is desired. This terminal is powered whenever compressor is locked out due to HPC or LPC sequences as described.

NOTE: Both high and low pressure switch controls are inherently automatic reset devices. The high pressure switch and low pressure switch cut out and cut in settings are fixed by specific air conditioner or heat pump unit model. The lockout features, both soft and manual, are a function of the Compressor Control Module.

ADJUSTMENTS

ADJUSTABLE DELAY-ON-MAKE AND DELAY-ON-BREAK TIMER

The potentiometer is used to select Delay-on-Break time from 30 seconds to 5 minutes. Delay-on-Make (DOM) timing on power-up and after power interruptions is equal to 2 minutes plus 10% of Delay-on-Break (DOB) setting:

0.5 minute	(30 seconds)	DOB = 123 second	DOM
1.0 minute	(60 seconds)	DOB = 126 second	DOM
2.0 minute	(120 seconds)	DOB = 132 second	DOM
3.0 minute	(160 seconds)	DOB = 138 second	DOM
4.0 minute	(240 seconds)	DOB = 144 second	DOM
5.0 minute	(300 seconds)	DOB = 150 second	DOM

LOW AMBIENT CONTROL

Optional Low Ambient Control

An optional low ambient control is available for both factory and field installed options. The low ambient control is to be applied to the PA13 Series models when operation below 55° outdoor conditions are anticipated. Without this device, the evaporating pressure would fall off, and the indoor coil would ice over.

The fan cycling control cycles the fan motor on, once the liquid refrigerant pressure reaches 350 psig, and off, once it has dropped to 225 psig. It will continue to cycle between these parameters depending on outdoor temperatures and the load/stage of the system.

This cycling maintains a minimum liquid pressure affecting the minimum suction pressure. This effect insures an evaporating temperature that is slightly above the point of ice formation on the evaporator.

This field installed option is Bard Part #CMA-28. See Figure 7.

**FIGURE 7
LOW AMBIENT CONTROL WIRING**

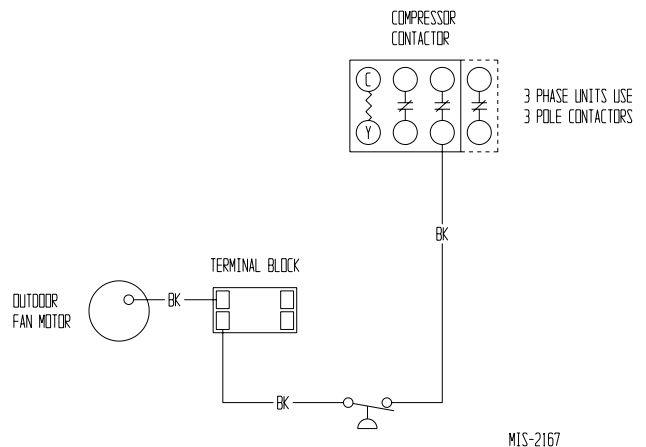

SERVICE AND TROUBLESHOOTING

SERVICE HINTS

1. Caution homeowner to maintain clean air filters at all times. Also, not to needlessly close off supply and return air registers. This reduces airflow through the system which shortens equipment service life as well as increasing operating costs.
2. Check all power fuses or circuit breakers to be sure that they are the correct rating.
3. Periodic cleaning of the outdoor coil to permit full and unrestricted airflow circulation is essential.

PRESSURE SERVICE PORTS

High and low pressure service ports are installed on all units so that the system operating pressures can be observed. Pressure tables can be found later in this manual covering all models on cooling cycle. It is imperative to match the correct pressure table to the unit by model number.

REFRIGERANT CHARGE

The correct system R-410A charge is shown on the unit rating plate.

You can reference Tables 10 & 11 to validate proper system performance. However, it is recommended that if incorrect charge is suspected, the system be reclaimed, evacuated and charged to the nameplate quantity and type.

The nameplate charge quantity is optimized for thermal performance and efficiency of this self-contained package system.

FAN BLADE SETTINGS

Shown in Figure 8 are the correct fan blade setting dimensions for proper air delivery across the outdoor coil.

Any service work requiring removal or adjustment in the fan and/or motor area will require that the dimensions below be checked and blade adjusted in or out on the motor shaft accordingly.

**FIGURE 8
FAN BLADE SETTING**

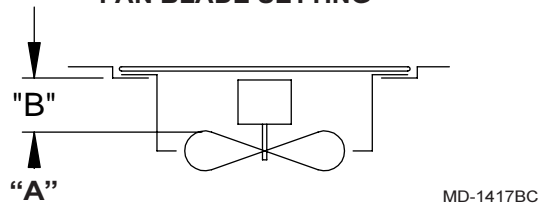

MD-1417BC

**TABLE 8
FAN BLADE SETTING DIMENSIONS**

Model	Dimension "A"
PA1324	3¼"
PA1330	
PA1336	
PA1342	
PA1348	
PA1360	

**TABLE 9
INDOOR BLOWER PERFORMANCE ①**

Model	Rated ESP	MAX ESP	② Continuous Airflow	③ Rated Cooling CFM	④ Rated Heating CFM
PA1324	0.10	0.50	600	800	800
PA1330	0.15	0.50	750	1000	1000
PA1336	0.15	0.50	825	1100	1100
PA1342	0.20	0.50	925	1400	1400
PA1348	0.20	0.50	1025	1550	1550
PA1360	0.20	0.50	1150	1650	1650

1 Motor will deliver consistent CFM through voltage supply range with no deterioration (197-253V for all 230/208V models).

2 Continuous CFM is the total air being circulated during continuous (manual fan) mode.

3 Will occur automatically with a call for "Y" for cooling mode operation.

4 Will occur automatically with a call for "W1" for heating mode operation.

**TABLE 10
PRESSURE TABLE**

Air Temperature Entering Outdoor Coil Degree F

COOLING		Return Air Temperature	Pressure	Air Temperature Entering Outdoor Coil Degree F											
				65°	70°	75°	80°	85°	90°	95°	100°	105°	110°	115°	120°
PA1324	75° DB	125	Low Side	127	129	131	133	135	137	138	140	142	143	145	147
	62° WB	238	High Side	262	286	310	334	358	382	407	432	457	482	507	532
	80° DB	134	Low Side	136	138	140	142	144	146	148	150	151	153	155	157
	67° WB	244	High Side	269	293	318	343	367	392	418	443	469	494	520	546
	85° DB	144	Low Side	146	148	151	153	155	157	159	161	163	165	167	169
	72° WB	253	High Side	278	304	329	355	380	406	432	459	485	512	538	565
PA1330	75° DB	126	Low Side	128	131	133	135	137	139	141	143	145	148	150	152
	62° WB	246	High Side	267	289	310	332	353	374	402	429	457	484	512	539
	80° DB	135	Low Side	137	140	142	144	147	149	151	153	156	158	160	162
	67° WB	252	High Side	274	296	318	340	362	384	412	440	469	497	525	553
	85° DB	145	Low Side	148	150	153	155	158	160	163	165	167	170	172	174
	72° WB	261	High Side	284	306	329	352	375	397	427	456	485	514	543	573
PA1336	75° DB	125	Low Side	127	128	130	132	133	135	136	138	139	141	142	
	62° WB	247	High Side	271	295	320	344	369	393	418	443	468	494	519	
	80° DB	134	Low Side	136	137	139	141	142	144	146	147	149	150	152	
	67° WB	253	High Side	278	303	328	353	378	403	429	455	480	506	532	
	85° DB	144	Low Side	146	148	149	151	153	155	157	158	160	162	163	
	72° WB	262	High Side	288	314	339	365	391	417	444	471	497	524	551	

LOW SIDE PRESSURE ±2 PSIG
HIGH SIDE PRESSURE ±5 PSIG

Tables based upon rated CFM (airflow) across the evaporator coil.

If incorrect charge suspected (more than ±2 psig suction, ±5 psig liquid),

it is recommended refrigerant charge be reclaimed, system evacuated and charged to serial plate quantity.

(Continued on Page 20 in Table 11)

**TABLE 11
PRESSURE TABLE**

COOLING		Air Temperature Entering Outdoor Coil Degree F													
		Return Air Temperature	Pressure	65°	70°	75°	80°	85°	90°	95°	100°	105°	110°	115°	120°
PA1342	75° DB	Low Side	126	128	129	131	132	134	136	137	138	140	141	142	143
	62° WB	High Side	242	265	288	311	334	357	380	409	437	466	494	523	551
	80° DB	Low Side	135	137	138	140	142	143	145	146	148	149	151	152	153
	67° WB	High Side	248	272	295	319	343	366	390	419	448	478	507	536	565
PA1348	85° DB	Low Side	145	147	149	151	152	154	156	157	159	160	162	163	165
	72° WB	High Side	257	281	306	330	355	379	404	434	464	494	525	555	585
	75° DB	Low Side	125	127	128	129	130	132	133	134	136	137	139	140	142
	62° WB	High Side	239	263	287	311	335	359	383	410	438	465	492	520	547
PA1360	80° DB	Low Side	134	135	137	138	139	141	142	144	145	147	148	150	152
	67° WB	High Side	245	270	294	319	344	368	393	421	449	477	505	533	561
	85° DB	Low Side	144	145	147	148	150	151	153	154	156	158	160	161	163
	72° WB	High Side	254	279	305	330	356	381	407	436	465	494	523	552	581
PA1360	75° DB	Low Side	124	125	126	127	128	129	130	131	131	132	133	134	134
	62° WB	High Side	224	254	285	315	345	375	406	431	456	480	505	530	552
	80° DB	Low Side	133	134	135	136	137	138	139	140	141	141	142	143	143
	67° WB	High Side	230	261	292	323	354	385	416	442	467	493	518	544	563
PA1360	85° DB	Low Side	143	144	145	146	147	148	149	150	151	152	153	154	154
	72° WB	High Side	238	270	302	334	366	398	431	457	484	510	537	563	581

LOW SIDE PRESSURE +2 PSIG
HIGH SIDE PRESSURE ±5 PSIG

Tables based upon rated CFM (airflow) across the evaporator coil.

If incorrect charge suspected (more than +2 psig suction, ±5 psig liquid),

it is recommended refrigerant charge be reclaimed, system evacuated and charged to serial plate quantity.

SUCTION AND DISCHARGE TUBE BRAZING

Compliant Scroll compressors have copper plated steel suction and discharge tubes. These tubes are far more rugged and less prone to leaks than copper tubes used on other compressors. Due to different thermal properties of steel and copper, brazing procedures may have to be changed from those commonly used.

- To disconnect: heat joint Areas 2 and 3 slowly and uniformly until braze material softens and the tube can be pulled out of suction fitting. (See Figure 9.)
- To connect:
 - Recommended brazing materials: silfos with minimum 5% silver or silver braze material with flux.
 - Reinsert tube into fitting.
 - Heat tube uniformly in Area 1 moving slowly to Area 2. When joint reaches brazing temperature, apply brazing material. (See Figure 9)
 - Heat joint uniformly around the circumference to flow braze material completely around the joint.
 - Slowly move torch into Area 3 to draw braze material into joint. (See Figure 9.)
 - **Do not** overheat joint.

**FIGURE 9
BRAZING DIAGRAM**

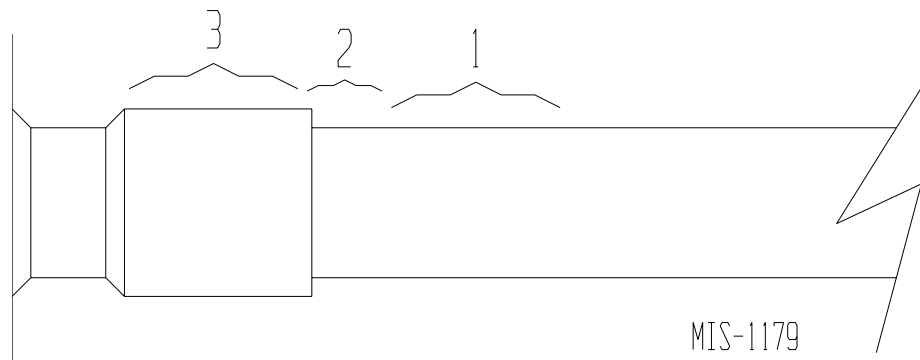

TROUBLESHOOTING GE X13-SERIES ECM2.3™ MOTORS

NOTE: Bard Models PA13242; PA13302; PA13362-A, -B; PA13422-A, -B, -C; PA13482-A, -B, -C; PA13602-A, -B, -C contain the X13-Series Motors.

If the Motor is Running

1. It is normal for the motor to rock back and forth on start up. Do not replace the motor if this is the only problem identified.
2. If the system is excessively noisy, does not appear to change speeds in response to a demand (Heat, Cool, Other), or is having symptoms during the cycle such as tripping limit or freezing coil, check the following:
 - a. Wait for programmed delays to time out.
 - b. Ensure that the motors control inputs are wired to the factory supplied wiring diagram to insure motor is getting proper control signals and sequencing.
 - c. Remove the filter and check that all dampers, registers, and grilles are open and free flowing. If removing the filters corrects the problem, clean or replace with a less restrictive filter. Also check and clean the blower wheel or coil as necessary.
 - d. Check the external static pressure (total of both supply and return) to insure that you are within the ranges as listed on the unit serial plate. If higher than allowed, additional duct work is needed.

- e. If the motor does not shut off at the end of the cycle, wait for any programmed delays to time out (no more than 90 seconds). Also make sure that there is no call for "Continuous Fan" on the "G" terminal.
- f. If the above diagnostics do not solve the problem, confirm the voltage checks in the next section below, then continue with the "Model X13 Communication Diagnostics".

If the Motor is Not Running

1. Check for proper high voltage and ground at the (L/L1) (G) (N/L2) connections at the motor (see Figure 10). Correct any voltage issues before proceeding to the next step. The X13 Motor is voltage specific. Only the correct voltage should be applied to the proper motor. Input voltage within plus or minus 10% of the nominal 230 VAC is acceptable.
2. If the motor has proper high voltage and ground at the (L/L1) (G) (N/L2) connections, then continue with the "Model X13 Communication Diagnostics".

FIGURE 10

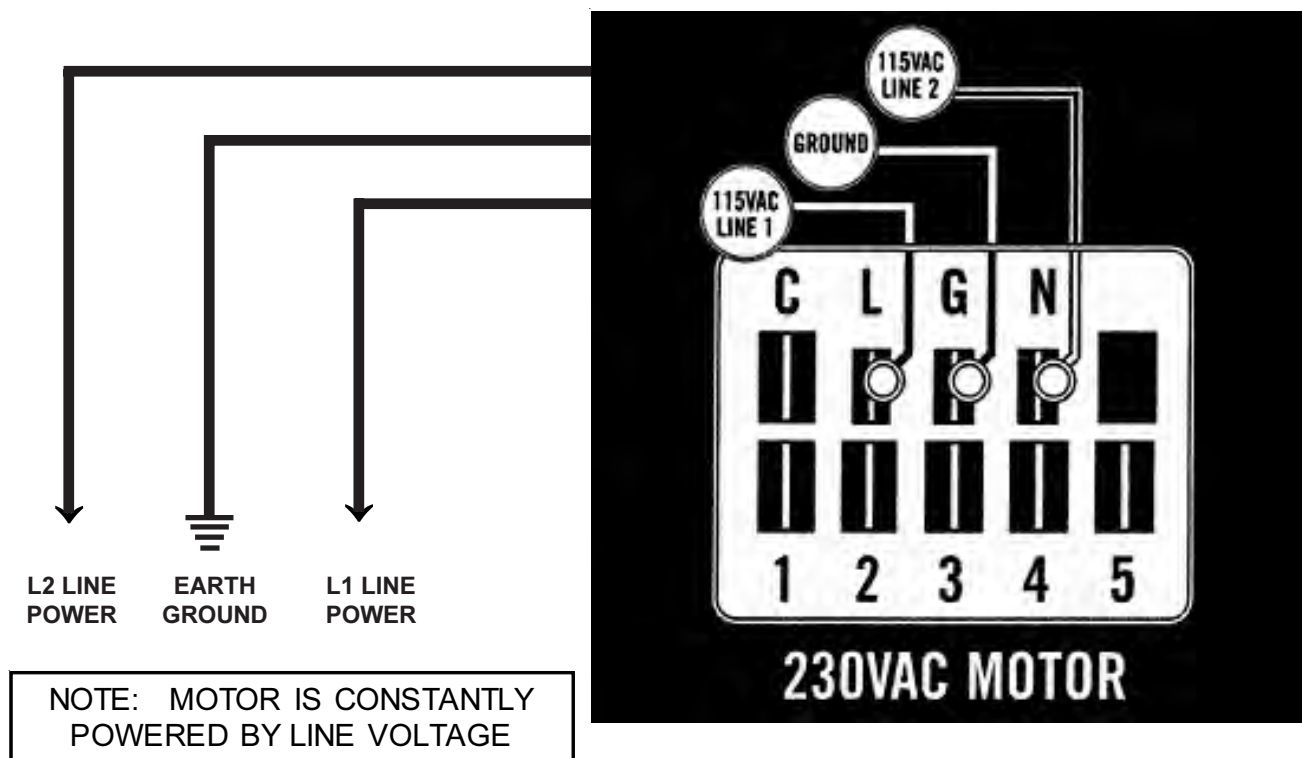

TROUBLESHOOTING GE X13-SERIES ECM2.3™ MOTORS CONT'D.

Model X13 Communication Diagnostics

The X13 motor is communicated through 24 VAC low voltage (Thermostat Control Circuit Wiring).

1. Start with unit wiring diagram to confirm proper connections and voltage (see Figure 11).
2. Initiate a demand from the thermostat and check the voltage between the common and the appropriate motor terminal (1-5). ("G" input is typically on terminal #1, but refer to wiring diagram!)
 - a. If the low voltage communication is not present, check the demand from the thermostat. Also check the output terminal and wire(s) from the terminal strip or control relay(s) to the motor.
 - b. If the motor has proper high voltage as identified above (Motor not Running #1), and proper low voltage to a programmed terminal, and is not operating, the motor is failed, and will require replacement.

FIGURE 11

