

---

# INSTALLATION INSTRUCTIONS

---

## WALL MOUNTED PACKAGE HEAT PUMPS

Model  
**WH612**



**Climate Control Solutions**

Bard Manufacturing Company, Inc.  
Bryan, Ohio 43506

*Since 1914...Moving ahead just as planned.*

Manual : 2100-480  
Supersedes: *NEW*  
File: Volume III Tab 17  
Date: 12-19-07

# CONTENTS

---

## Getting Other Information and Publications

For More Information .....	3
----------------------------	---

## Wall Mount General

Heat Pump Wall Mount Model Nomenclature .....	4
Shipping Damage .....	6
General .....	6
Duct Work .....	6 & 7
Filters .....	7
Fresh Air Intake .....	7
Condensate Drain – Evaporator .....	8
Condensate Drain – Condenser .....	8

## Installation Instructions

Wall Mounting Information .....	9
Mounting the Unit .....	9
Wiring – Main Power .....	14
Wiring – Low Voltage Wiring .....	14
Optional Outdoor Thermostats Applications .....	15
Optional Compressor Cutoff Thermostat .....	16
Electric Heat Hold-Off .....	16

## Figures

Figure 1 Unit Dimensions .....	5
Figure 2 Fresh Air Damper Assembly .....	7
Figure 3 Condensate Drains .....	8
Figure 4 Mounting Instructions .....	10
Figure 5 Electric Heat Clearance .....	11
Figure 6 Wall Mounting Instructions .....	12
Figure 7 Wall Mounting Instructions .....	12
Figure 8 Common Wall Mounting Installations ..	13
Figure 9 Unit 24V Terminal Board .....	14
Figure 10 Compressor Cutoff Thermostat Wiring .....	15
Figure 11 Compressor Cutoff Thermostat Wiring .....	15
Figure 12 Electric Heat Hold-Off Wiring .....	16
Figure 13 Electric Heat Hold-Off Wiring .....	16
Figure 14 Start Up Procedure Decal .....	18
Figure 15 Defrost Control Board .....	20
Figure 16 Fan Blade Setting .....	23

## Start Up

Important Installer Note .....	18
Crankcase Heaters .....	18
High Pressure Switch .....	18
Two Speed Outdoor Fan motors .....	18
Three Phase Scroll Compressor Start Up .....	18
Phase Monitor .....	19
Service Hints .....	19
Sequence of Operation .....	19
Pressure Service Ports .....	19
Defrost Cycle .....	19 & 20

## Troubleshooting

Solid State Heat Pump Control Troubleshooting Procedure .....	21
Checking Temperature Sensor Outside Unit Circuit .....	22
Temperature vs. Resistance of Temperature .....	22
Fan Blade Setting Dimensions .....	23
Removal of Fan Shroud .....	23
Refrigerant Charge .....	23
Pressure Tables .....	24

## Tables

Table 1 Electric Heat Table .....	4
Table 2 Electrical Specifications .....	6
Table 3 Thermostat Wire Size .....	14
Table 4 Wall Thermostat .....	17
Table 5 Troubleshooting .....	21
Table 6 Fan Blade Dimensions .....	23
Table 7 Refrigerant Charge .....	23
Table 8 Rated CFM and Rated ESP .....	23
Table 9 Indoor Blower Performance .....	23
Table 10 Maximum ESP of Operation .....	23
Table 11 Pressure Table - Cooling .....	24
Table 12 Pressure Table - Heating .....	24

# Getting Other Information and Publications

---

These publications can help you install the air conditioner or heat pump. You can usually find these at your local library or purchase them directly from the publisher. Be sure to consult current edition of each standard.

National Electrical Code ..... ANSI/NFPA 70

Standard for the Installation ..... ANSI/NFPA 90A  
of Air Conditioning and Ventilating Systems

Standard for Warm Air ..... ANSI/NFPA 90B  
Heating and Air Conditioning Systems

Load Calculation for ..... ACCA Manual J  
Residential Winter and Summer Air Conditioning

Duct Design for Residential ..... ACCA Manual D  
Winter and Summer Air Conditioning and Equipment  
Selection

## FOR MORE INFORMATION, CONTACT THESE PUBLISHERS:

**ACCA**     **Air Conditioning Contractors of America**  
1712 New Hampshire Ave. N.W.  
Washington, DC 20009  
Telephone: (202) 483-9370  
Fax: (202) 234-4721

**ANSI**     **American National Standards Institute**  
11 West Street, 13th Floor  
New York, NY 10036  
Telephone: (212) 642-4900  
Fax: (212) 302-1286

**ASHRAE**   **American Society of Heating Refrigerating,  
and Air Conditioning Engineers, Inc.**  
1791 Tullie Circle, N.E.  
Atlanta, GA 30329-2305  
Telephone: (404) 636-8400  
Fax: (404) 321-5478

**NFPA**     **National Fire Protection Association**  
Batterymarch Park  
P.O. Box 9101  
Quincy, MA 02269-9901  
Telephone: (800) 344-3555  
Fax: (617) 984-7057

# WALL MOUNT GENERAL INFORMATION

## HEAT PUMP WALL MOUNT MODEL NOMENCLATURE

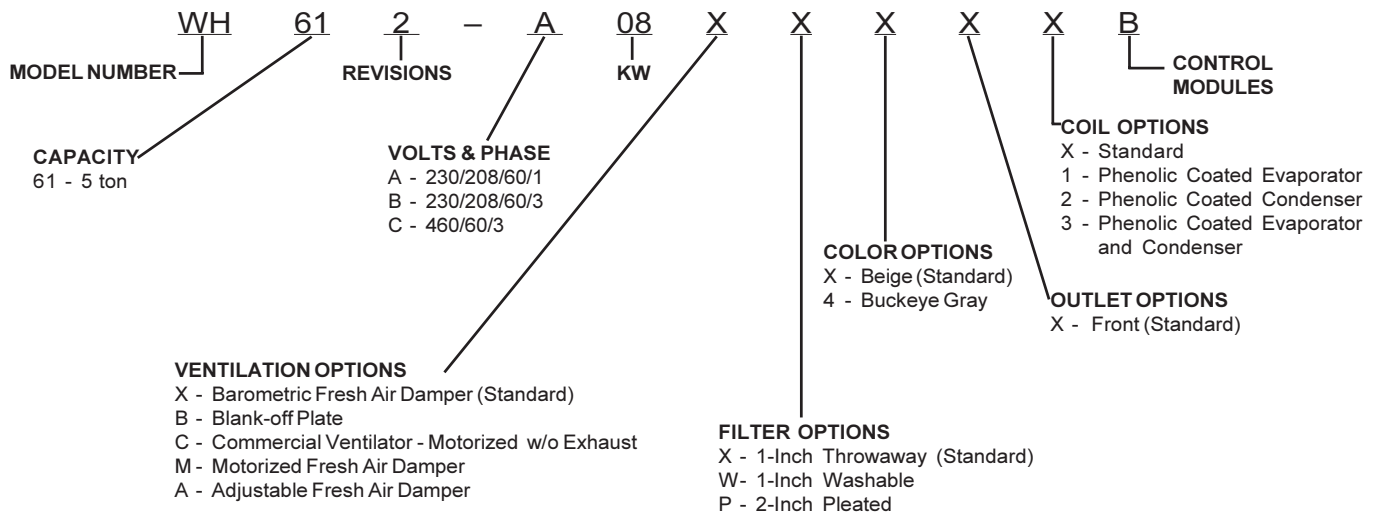

NOTE: All vent options are without exhaust capability. May require separate field supplied barometric relief in building.

**TABLE 1  
ELECTRIC HEAT TABLE**

Models	WH612-A				WH612-B				WH612-C	
	240-1		208-1		240-3		208-3		460-3	
	Amps	BTU	Amps	BTU	Amps	BTU	Amps	BTU	Amps	BTU
<b>5</b>	20.8	17,065	18.1	12,800	---	---	---	---	---	---
<b>8</b>	33.3	27,280	28.8	20,450	---	---	---	---	---	---
<b>9</b>	---	---	---	---	21.7	30,600	18.7	23,030	10.8	30,700
<b>10</b>	41.6	34,130	36.2	25,600	---	---	---	---	---	---
<b>20</b>	83.2	68,260	72.4	51,200	---	---	---	---	---	---

**FIGURE 1  
UNIT DIMENSIONS**

Unit	Width W	Depth D	Height H	Supply			Return			J	K	L	M	N	O	P	Q		
				A	B	C	B	C	E									F	G
WH612	42	22-1/4	94-7/8	9-7/8	29-7/8	15-7/8	29-7/8	43-7/8	19	41-5/8	30	42-11/16	37	44-3/4	42-1/2	3-1/4	43	33-7/8	10

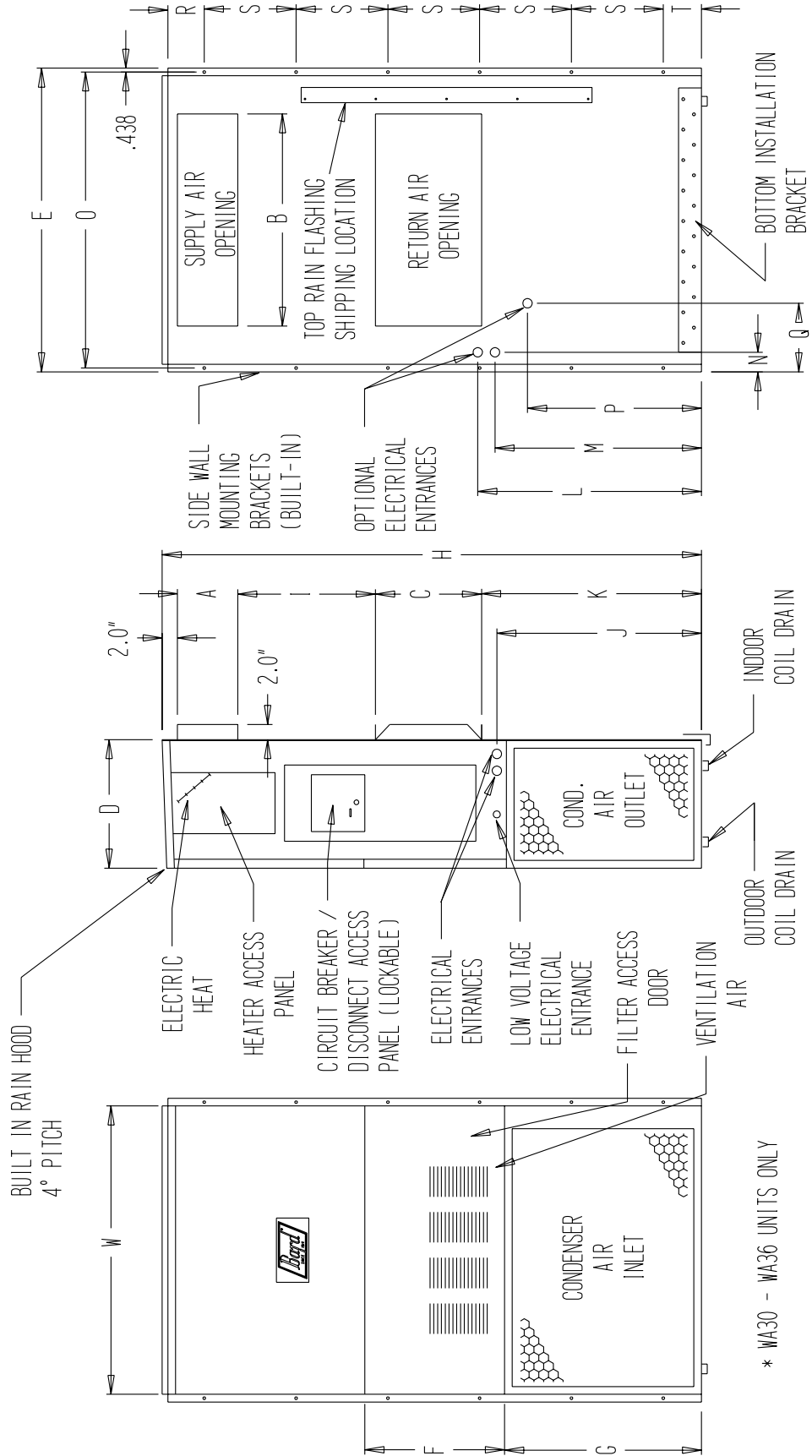

\* WA30 - WA36 UNITS ONLY

MIS-1770

**BACK VIEW**

**SIDE VIEW**

**FRONT VIEW**

**TABLE 2  
ELECTRICAL SPECIFICATIONS**

Model	SINGLE CIRCUIT						DUAL CIRCUIT								
	Rated Volts & Phase	No. Field Power Circuits	③	①	②	②	③		①		②		②		
			Minimum Circuit Ampacity	Maximum External Fuse or Circuit Breaker	Field Power Wire Size	Ground Wire Size	Minimum Circuit Ampacity	Maximum External Fuse or Circuit Breaker	Field Power Wire Size	Ground Wire Size	Ckt. A	Ckt. B	Ckt. A	Ckt. B	Ckt. A
WH612-A00, A0Z	230/208-1	1	46	60	8	10	---	---	---	---	---	---	---	---	---
A05	230/208-1	1 or 2	72	90	4	8	46	26	60	30	8	10	10	10	
A08	230/208-1	1 or 2	88	90	3	8	46	42	60	50	8	8	10	10	
A10	230/208-1	1 or 2	98	100	3	8	46	52	60	60	8	6	10	10	
A20	230/208-1	1 or 2	111	120	2	8	46	52	60	60	8	6	10	10	
WH612-B00, B0Z	230/208-1	1	33	45	8	10	---	---	---	---	---	---	---	---	
B09	230/208-1	1	59	60	8	10	---	---	---	---	---	---	---	---	
WH612-C00, C0Z	460-3	1	15	20	12	10	---	---	---	---	---	---	---	---	
C09	460-3	1	29	30	10	10	---	---	---	---	---	---	---	---	

① Maximum size of the time delay fuse or HACR type circuit breaker for protection of field wiring conductors.

② Based on 75° C copper wire. All wiring must conform to NEC and all local codes.

③ These "Minimum Circuit Ampacity" values are to be used for sizing the field power conductors. Refer to the National Electric Code (latest revision), article 310 for power conductor sizing.

**CAUTION:** When more than one field power conductor circuit is run through one conduit, the conductors must be derated. Pay special attention to note 8 of table 310 regarding Ampacity Adjustment Factors when more than 3 conductors are in a raceway.

## SHIPPING DAMAGE

Upon receipt of equipment, the carton should be checked for external signs of shipping damage. If damage is found, the receiving party must contact the last carrier immediately, preferably in writing, requesting inspection by the carrier's agent.

## GENERAL

The equipment covered in this manual is to be installed by trained, experienced service and installation technicians.

The refrigerant system is completely assembled and charged. All internal wiring is complete.

The unit is designed for use with or without duct work. Flanges are provided for attaching the supply and return ducts.

These instructions explain the recommended method to install the air cooled self-contained unit and the electrical wiring connections to the unit.

These instructions and any instructions packaged with any separate equipment, required to make up the entire air conditioning system should be carefully read before beginning the installation. Note particularly "Starting Procedure" and any tags and/or labels attached to the equipment.

While these instructions are intended as a general recommended guide, they do not supersede any national and/or local codes in any way. Authorities having jurisdiction should be consulted before the installation is made. See Page 3 for information on codes and standards.

Size of unit for a proposed installation should be based on heat loss calculation made according to methods of Air Conditioning Contractors of America (ACCA). The air duct should be installed in accordance with the Standards of the National Fire Protection Association for the Installation of Air Conditioning and Ventilating Systems of Other Than Residence Type, NFPA No. 90A, and Residence Type Warm Air Heating and Air Conditioning Systems, NFPA No. 90B. Where local regulations are at a variance with instructions, installer should adhere to local codes.

## DUCT WORK

Any heat pump is more critical of proper operating charge and an adequate duct system than a straight air conditioning unit. All duct work, supply and return, must be properly sized for the design airflow requirement of the equipment. Air Conditioning Contractors of America (ACCA) is an excellent guide to proper sizing. All duct work or portions thereof not in the conditioned space should be properly insulated in order to both conserve energy and prevent condensation or moisture damage.

Design the duct work according to methods given by the Air Conditioning Contractors of America (ACCA). When duct runs through unheated spaces, it should be insulated with a minimum of one inch of insulation. Use insulation with a vapor barrier on the outside of the insulation. Flexible joints should be used to connect the duct work to the equipment in order to keep the noise transmission to a minimum.

A 1/4 inch clearance to combustible material for the first three feet of duct attached to the outlet air frame is required. See Wall Mounting Instructions and Figures 4, 5, 6 and 7 for further details.

Ducts through the walls must be insulated and all joints taped or sealed to prevent air or moisture entering the wall cavity.

Some installations may not require any return air duct. A metallic return air grille is required with installations not requiring a return air duct. The spacing between louvers on the grille shall not be larger than 5/8 inch.

*NOTE: If no return air duct is used, applicable installation codes may limit this cabinet to installation only in a single story structure.*

Any grille that meets with 5/8 inch louver criteria may be used. It is recommended that Bard Return Air Grille Kit RG2 through RG5 or RFG2 through RFG5 be installed when no return duct is used. (RFG filter is not included; must order separately.) Contact distributor or factory for ordering information. If using a return air filter grille, filters must be of sufficient size to allow a maximum velocity of 400 fpm.

## FILTERS

A 1-inch throwaway filter is supplied with each unit. The filter slides into position making it easy to service. This filter can be serviced from the outside by removing the service door. A 1-inch washable filter and a 2-inch pleated filter are also available as optional accessories. The internal filter brackets are adjustable to accommodate the 2-inch filter by bending down the two horizontal tabs on each filter bracket.

## FRESH AIR INTAKE

All units are built with fresh air inlet slots punched in the service panel.

If the unit is equipped with a fresh air damper assembly, the assembly is shipped already attached to the unit. The damper blade is locked in the closed position. To allow the damper to operate, the maximum and minimum blade position stops must be installed. See Figure 2.

All capacity, efficiency and cost of operation information as required for Department of Energy "Energyguide" Fact Sheets is based upon the fresh air Blank-off plate in place and is recommended for maximum energy efficiency.

The blank-off plate is available upon request from the factory and is installed in place of the fresh air damper shipped with each unit.

**FIGURE 2  
FRESH AIR DAMPER**

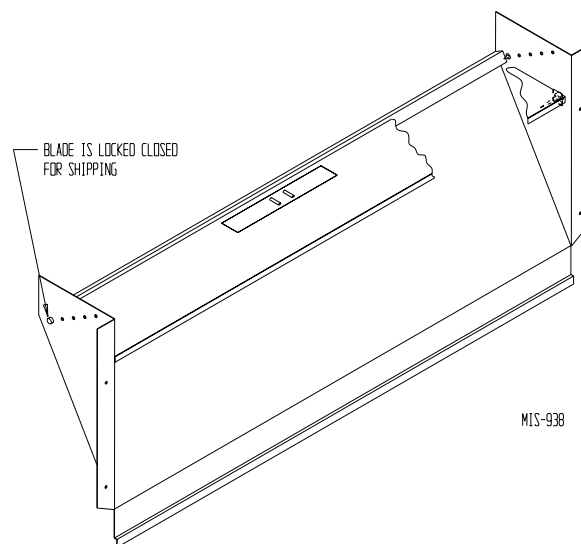

## CONDENSATE DRAIN – EVAPORATOR

A plastic drain hose extends from the drain pan at the top of the unit down to the unit base. There are openings in the unit base for the drain hose to pass through. In the event the drain hose is connected to a drain system of some type, it must be an open or vented type system to assure proper drainage.

## CONDENSATE DRAIN – CONDENSER

A hole is provided in the unit base to accept a Drain Connection Kit 8620-160. This allows connection of the unit base pan to a drain if so desired. (See Figure 3 and instructions provided with the 8620-160 kit.) In the event the drain hose is connected to a drain system of some type, it must be an open or vented type system to assure proper drainage.

**FIGURE 3  
CONDENSATE DRAINS**

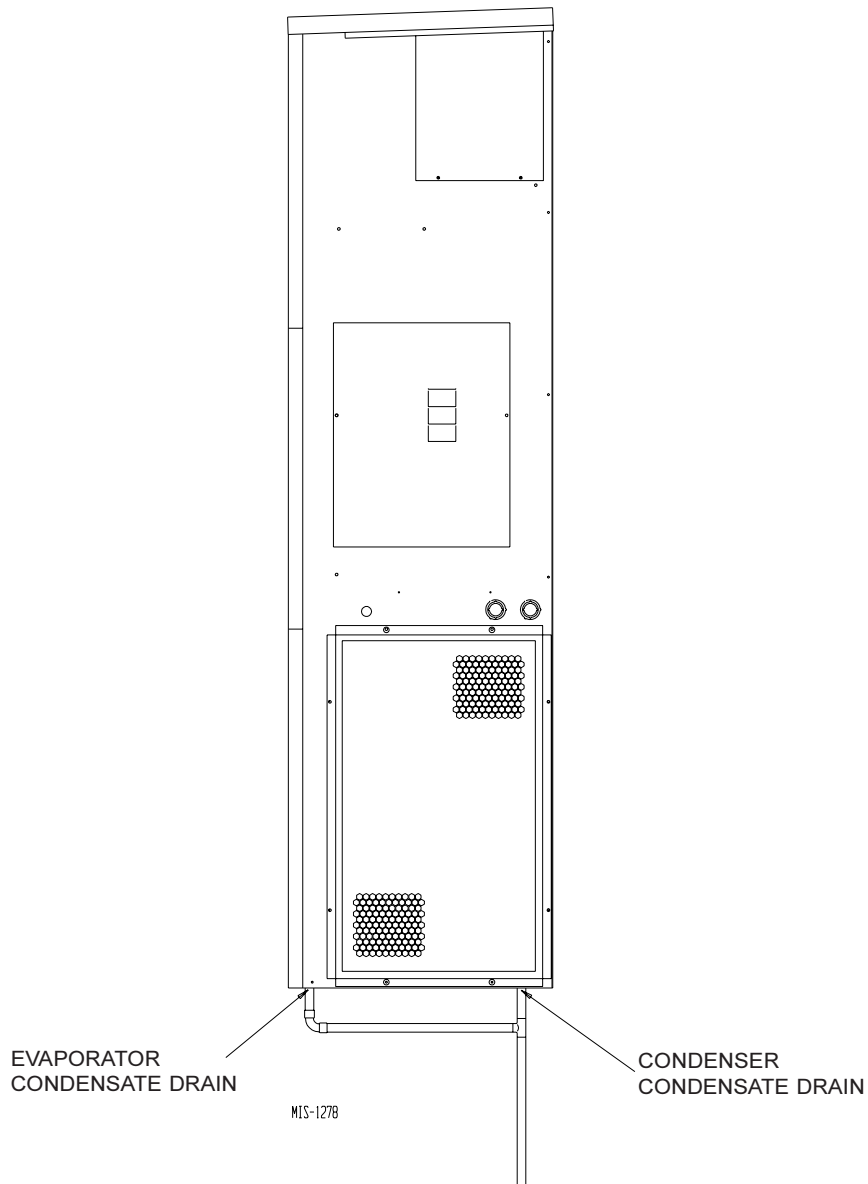



# INSTALLATION INSTRUCTIONS

## WALL MOUNTING INFORMATION

1. Two holes for the supply and return air openings must be cut through the wall as shown in Figure 4.
2. On wood frame walls, the wall construction must be strong and rigid enough to carry the weight of the unit without transmitting any unit vibration.

### **WARNING**

Fire hazard can result if 1/4 inch clearance to combustible materials for supply air duct is not maintained. See Figure 5.

3. Concrete block walls must be thoroughly inspected to insure that they are capable of carrying the weight of the installed unit.

## MOUNTING THE UNIT

1. These units are secured by wall mounting brackets which secure the unit to the outside wall surface at both sides. A bottom mounting bracket is provided for ease of installation, but is not required.
2. The unit itself is suitable for 0 inch clearance, but the supply air duct flange and the first 3 feet of supply air duct require a minimum of 1/4 inch clearance to combustible material. If a combustible wall use a minimum of 30½" x 10½" dimensions for sizing. However, it is generally recommended that a 1-inch clearance is used for ease of installation and maintaining the required clearance to combustible material. The supply air opening would then be 32" x 12". See Figures 4 and 5 for details.

### **WARNING**

Failure to provide the 1/4 inch clearance between the supply duct and a combustible surface for the first 3 feet of duct can result in fire causing property damage, injury or death.

3. Locate and mark lag bolt locations and bottom mounting bracket location. See Figure 4.
4. Mount bottom mounting bracket.
5. Hook top rain flashing under back bend of top. Top rain flashing is shipped with unit attached to back of unit on the right side of the supply and return openings.
6. Position unit in opening and secure with 5/16 lag bolts; use 3/4 inch diameter flat washers on the lag bolts.
7. Secure rain flashing to wall and caulk across entire length of top. See Figure 4.
8. For additional mounting rigidity, the return air and supply air frames or collars can be drilled and screwed or welded to the structural wall itself (depending upon wall construction). Be sure to observe required clearance if combustible wall.
9. On side-by-side installations, maintain a minimum of 20 inches clearance on right side to allow access to control panel and heat strips, and to allow proper airflow to the outdoor coil. Additional clearance may be required to meet local or national codes.

**FIGURE 4**  
**MOUNTING INSTRUCTIONS**

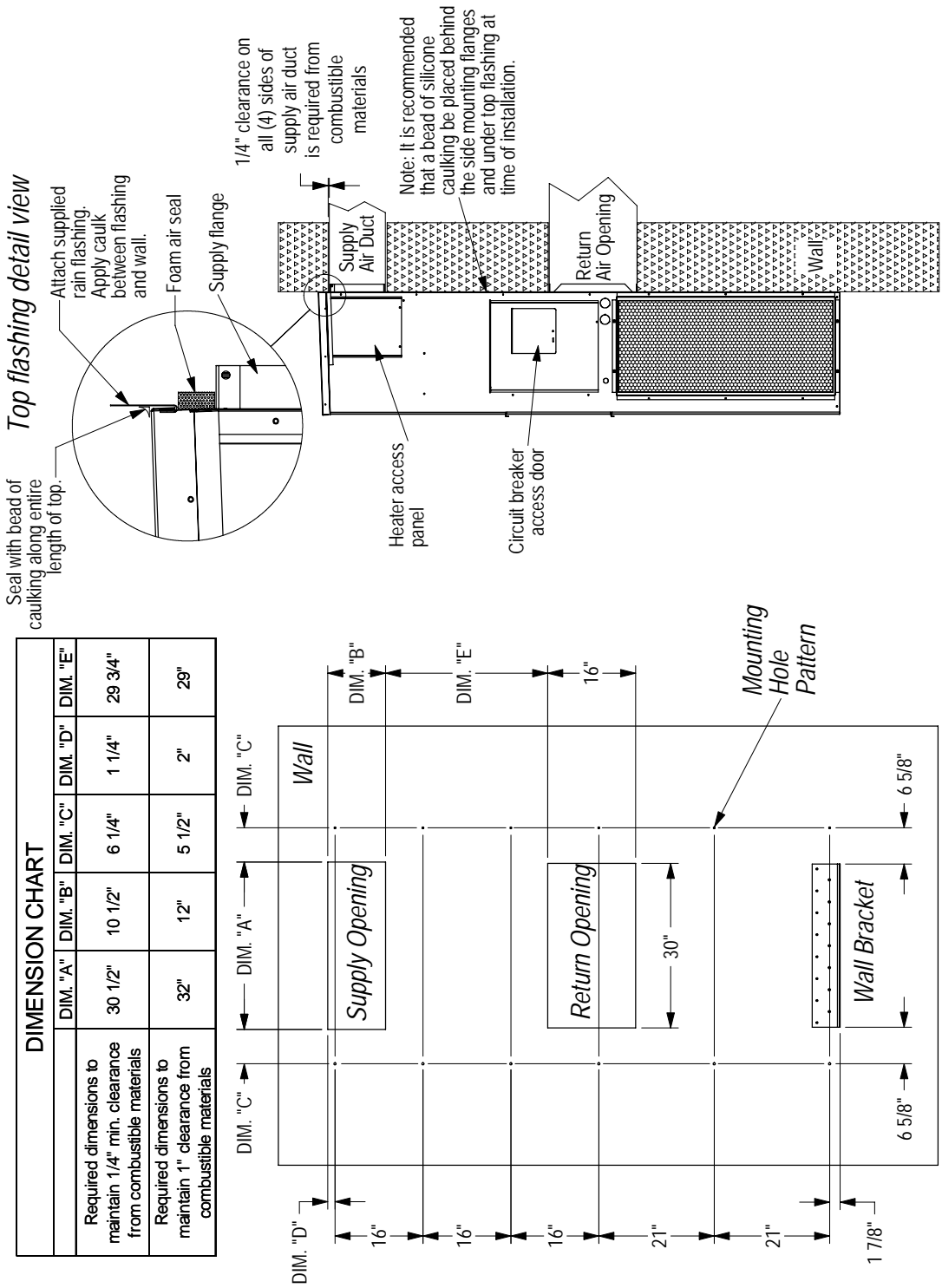

MIS-796-A

Side view of wall with unit installed

Front view of wall with unit removed

**FIGURE 5  
ELECTRIC HEAT CLEARANCE**

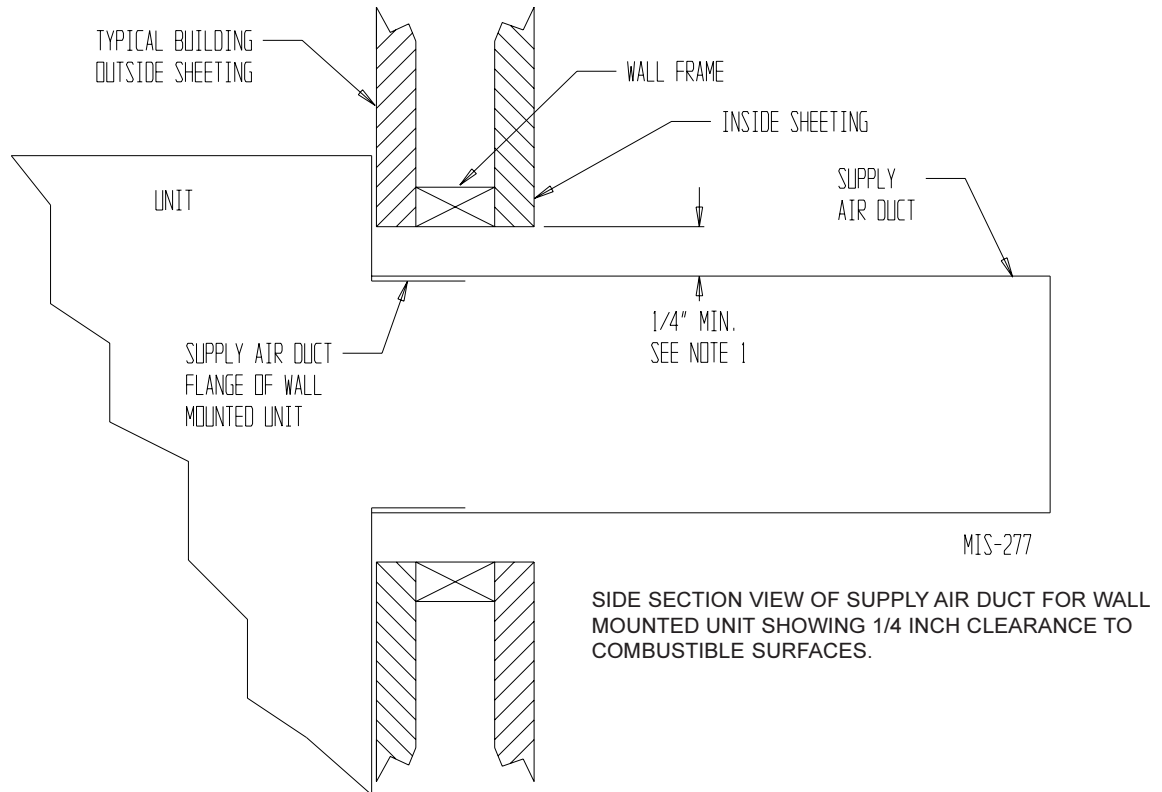

**SIDE SECTION VIEW OF SUPPLY AIR DUCT FOR WALL MOUNTED UNIT SHOWING 1/4 INCH CLEARANCE TO COMBUSTIBLE SURFACES.**



## **WARNING**

A minimum of 1/4 inch clearance must be maintained between the supply air duct and combustible materials. This is required for the first 3 feet of ducting.

It is important to insure that the 1/4 inch minimum spacing is maintained at all points.

Failure to do this could result in overheating the combustible material and may result in a fire causing property damage, injury or death.

## FIGURE 6 WALL MOUNTING INSTRUCTIONS

SEE FIGURE 4 – MOUNTING INSTRUCTIONS

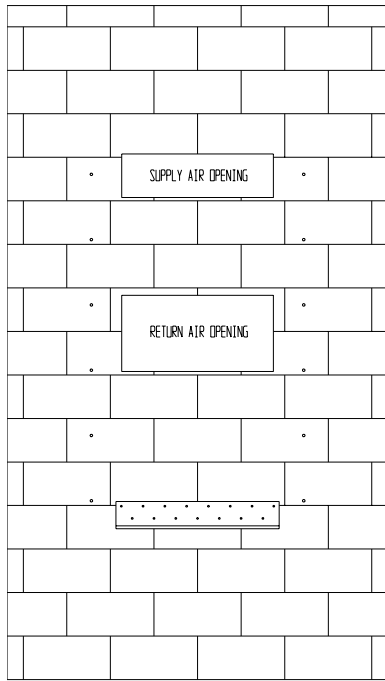

CONCRETE BLOCK WALL INSTALLATION

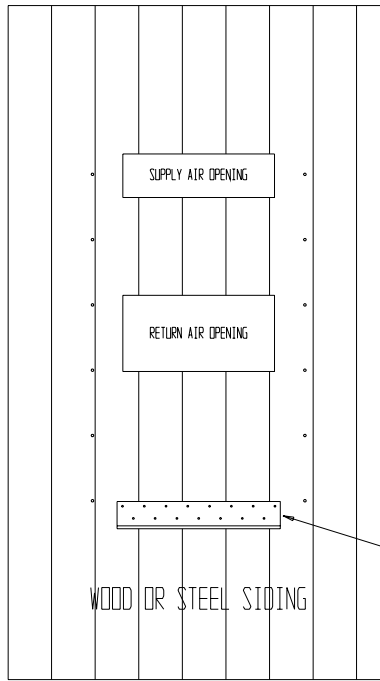

WOOD FRAME WALL INSTALLATION

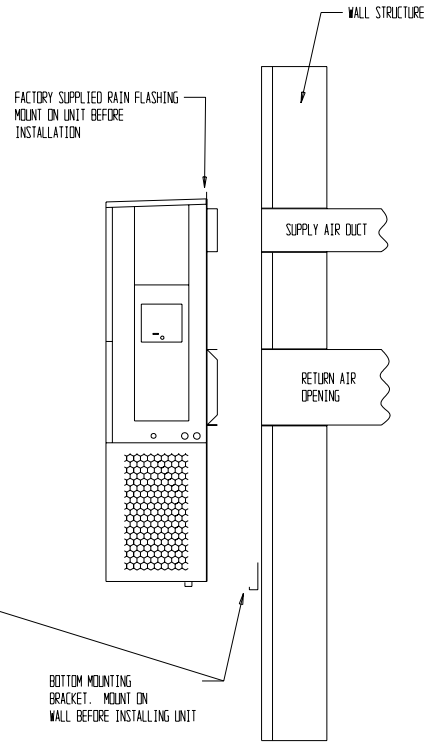

MIS-548

## FIGURE 7 WALL MOUNTING INSTRUCTIONS

SEE UNIT DIMENSIONS, FIGURE 1, FOR ACTUAL DIMENSIONS

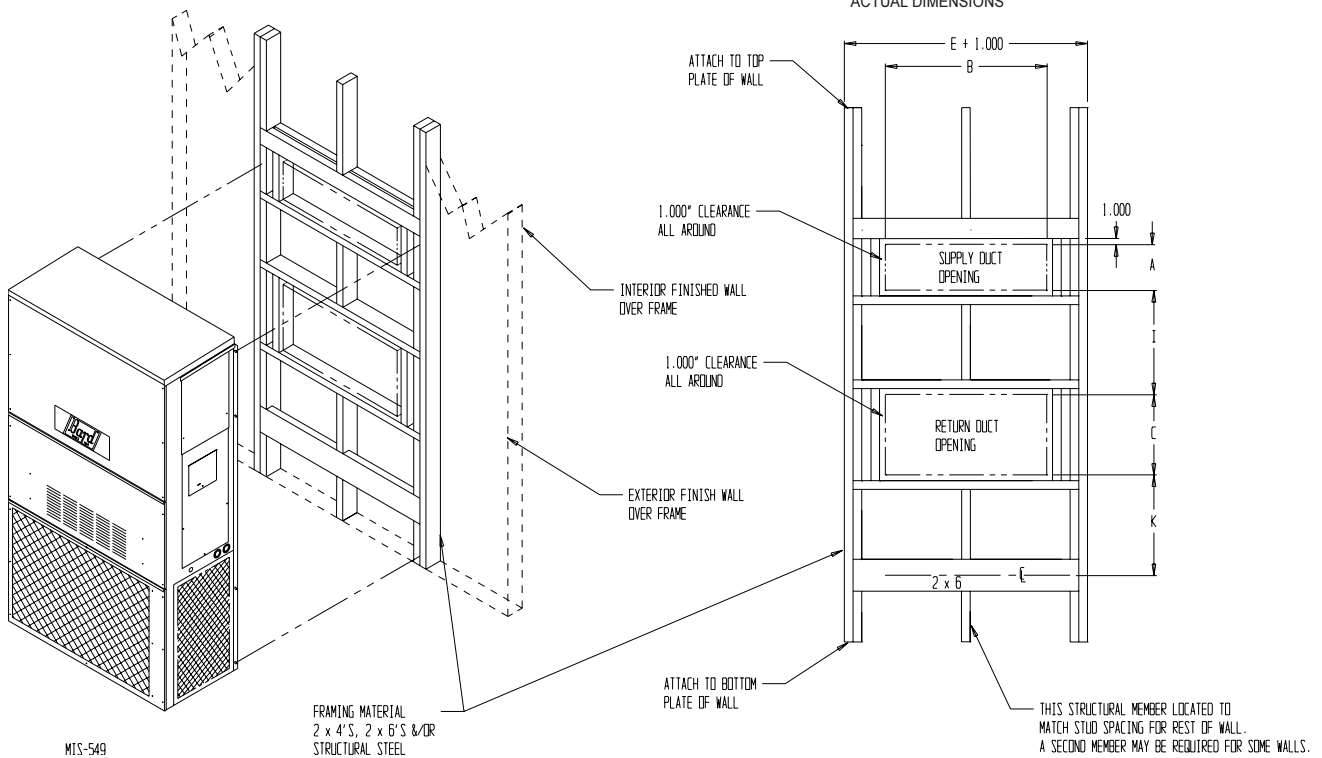

MIS-549

**FIGURE 8  
COMMON WALL MOUNTING INSTALLATIONS**

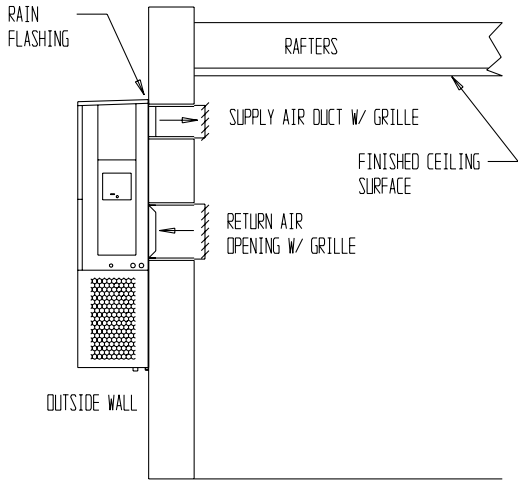

FREE AIR FLOW  
NO DUCT

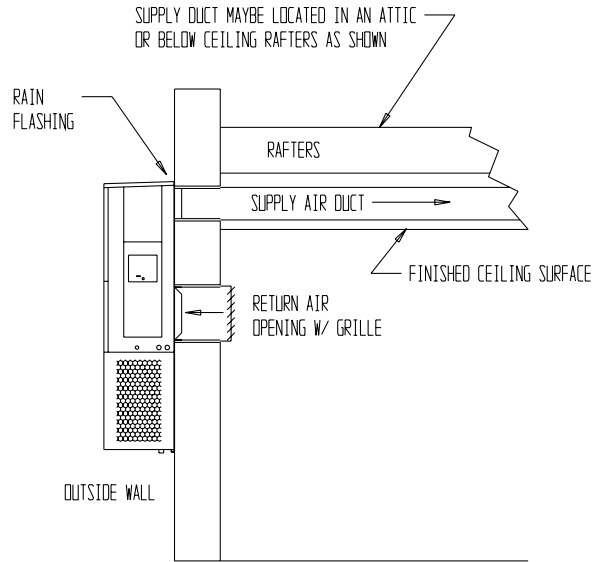

DUCTED SUPPLY  
RETURN AT UNIT

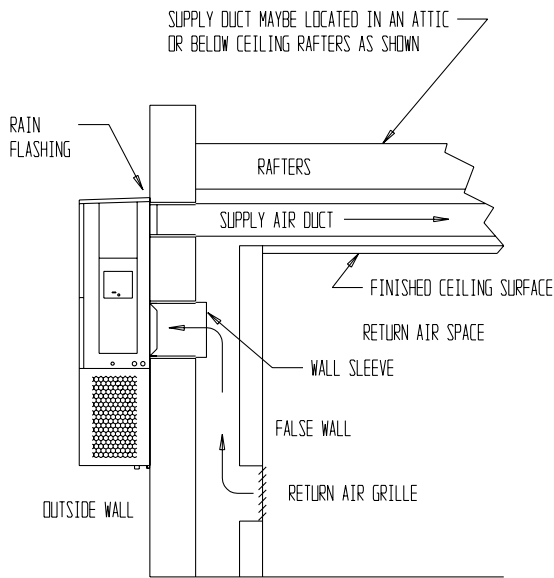

FALSE WALL INSTALLATION

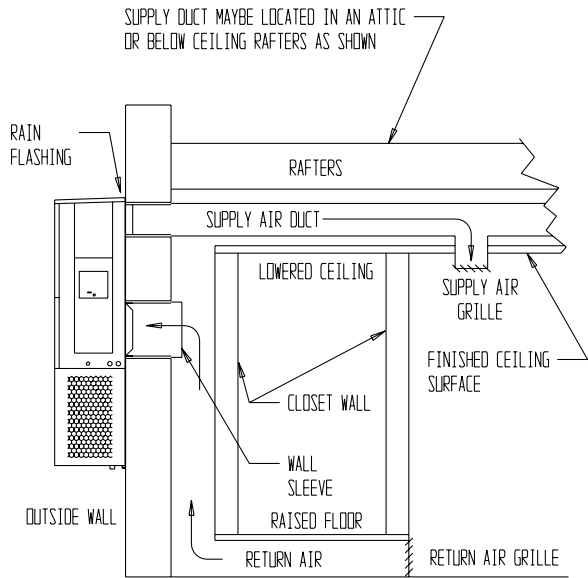

CLOSET INSTALLATION

MIS-550

## WIRING – MAIN POWER

Refer to the unit rating plate for wire sizing information and maximum fuse or “HACR” type circuit breaker size. Each outdoor unit is marked with a “Minimum Circuit Ampacity”. This means that the field wiring used must be sized to carry that amount of current. Depending on the installed KW of electric heat, there may be two field power circuits required. If this is the case, the unit serial plate will so indicate. All models are suitable only for connection with copper wire. Each unit and/or wiring diagram will be marked “Use Copper Conductors Only”. These instructions **must be** adhered to. Refer to the National Electrical Code (NEC) for complete current carrying capacity data on the various insulation grades of wiring material. All wiring must conform to NEC and all local codes.

The electrical data lists fuse and wire sizes (75°C copper) for all models including the most commonly used heater sizes. Also shown are the number of field power circuits required for the various models with heaters.

The unit rating plate lists a “Maximum Time Delay Relay Fuse” or “HACR” type circuit breaker that is to be used with the equipment. The correct size must be used for proper circuit protection and also to assure that there will be no nuisance tripping due to the momentary high starting current of the compressor motor.

The disconnect access door on this unit may be locked to prevent unauthorized access to the disconnect. To convert for the locking capability, bend the tab locate in the bottom left hand corner of the disconnect opening under the disconnect access panel straight out. This tab will now line up with the slot in the door. When shut a padlock may be placed through the hole in the tab preventing entry.

See “Start Up” section for important information on three phase scroll compressor start ups.

**TABLE 3  
THERMOSTAT WIRE SIZE**

Transformer VA	FLA	Wire Gauge	Maximum Distance in Feet
55	2.3	20 gauge	45
		18 gauge	60
		16 gauge	100
		14 gauge	160
		12 gauge	250

## WIRING – LOW VOLTAGE WIRING

230/208V, 1-phase and 3-phase equipment dual primary voltage transformers. All equipment leaves the factory wired on 240V tap. For 208V operation, reconnect from 240V to 208V tap. The acceptable operating voltage range for the 240 and 208V taps are:

TAP	RANGE
240	253 – 216
208	220 – 187

**FIGURE 9  
UNIT 24V TERMINAL BOARD**

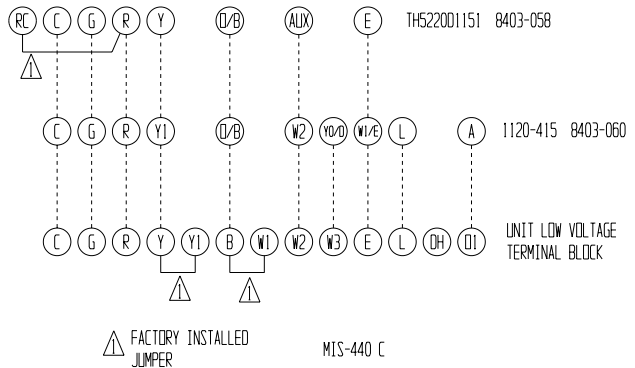

**NOTE:** The voltage should be measured at the field power connection point in the unit and while the unit is operating at full load (maximum amperage operating condition).

If no motorized vent option is used, nine (9) wires should be run from the thermostat subbase to the 24V terminal board in the unit. A nine (9) conductor, 18 gauge copper color-coded thermostat cable is recommended. If a motorized vent option is used, terminal O1 on the unit low voltage terminal block will also be used. This requires a ten (10) conductor thermostat cable to be run. The connection points are shown in Figure 9.

## IMPORTANT

Only the thermostats shown in this Manual have been tested with this equipment for proper operation. Proper unit operation with thermostats not listed in this Manual, cannot be assured.

You assume responsibility for proper operation of the unit when using thermostats other than those listed in this Manual.

**FIGURE 10**  
**COMPRESSOR CUTOFF THERMOSTAT WIRING**  
**4 – 10KW 1 PH – 6 & 9KW 3 PH**

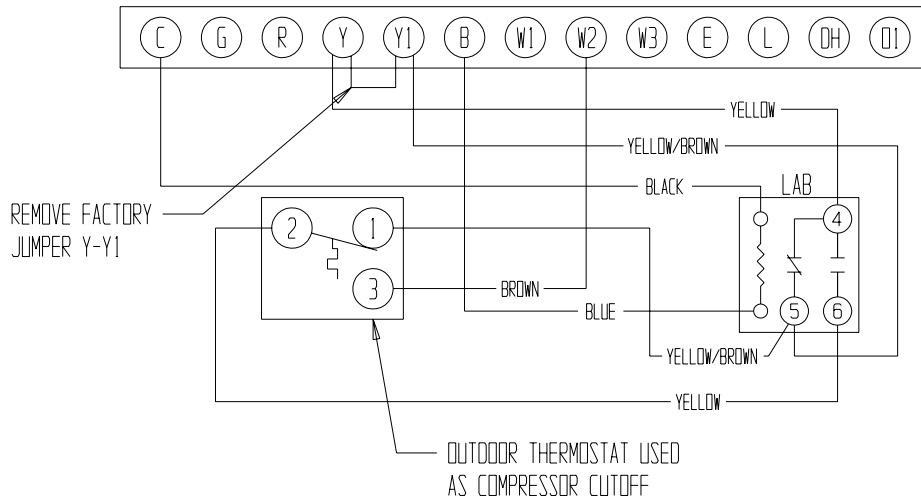

**FIGURE 11**  
**COMPRESSOR CUTOFF THERMOSTAT WIRING**  
**15 – 20KW 1 PH AND 3 PH**

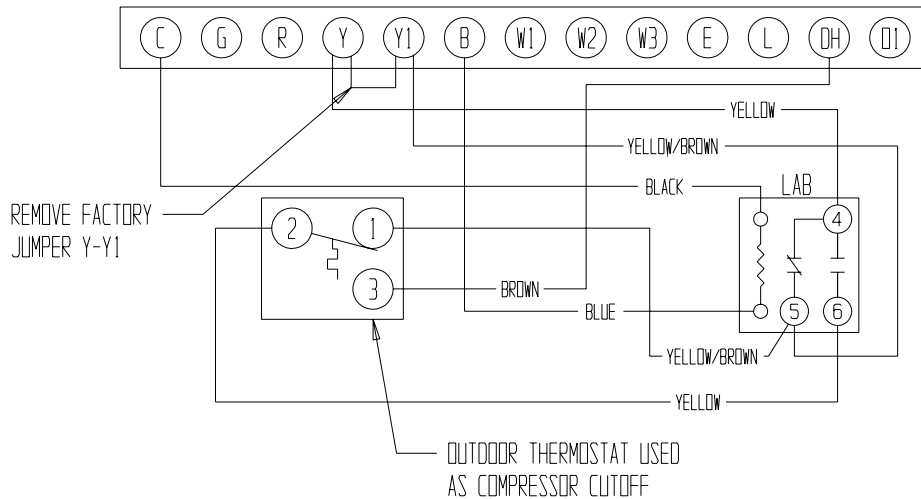

MIS-409 A

**OPTIONAL OUTDOOR THERMOSTAT APPLICATIONS**

Since most equipment at the time of manufacture is not designated for any specific destination of the country and are installed in areas not approaching the lower outdoor temperature range, outdoor thermostats are not factory installed as standard equipment, but are offered as an option. There are also different applications for applying outdoor thermostats. The set point of either type of outdoor thermostat application is variable with geographic region and sizing of the heating equipment to the individual structure. Utilization of the heating Application Data, and the heat loss calculation of the building are useful in determining the correct set points.

Temperature and Humidity Controller #8403-060, along with the Outdoor Sensor option Part #8403-061, can be used to:

- Limit minimum outdoor temperature for cooling option.
- Limit minimum outdoor temperature for heat pump option.
- Inhibit electric heat operation for heat pumps above selected outdoor temperature.

Thus, not requiring the optional compressor cut-off thermostat or the electric heat cut-off thermostat option.

**OPTIONAL COMPRESSOR CUTOFF THERMOSTAT (See Figures 10 and 11)**

Heat pump compressor operation at outdoor temperatures below 0°F are neither desirable nor advantageous in term of efficiency. An outdoor thermostat can be applied to take the mechanical heating (compressor) off line, and send the (compressor) signal to energize electric heat in its place (to make electric heat first stage heating). This can also be applied to bank the quantity of available electric heat. For example: A heat pump operates with 10KW second stage heat – once the outdoor thermostat has switched then operates 15KW without the compressor as first stage heat.

*NOTE: The additional LAB (low ambient bypass) relay is required to prevent heater operation during low temperature cooling operation.*

**ELECTRIC HEAT HOLD-OFF (See Figures 12 and 13)**

In other applications, it is desirable to disable the operation of the electric heat until outdoor temperatures have reached a certain design point. This won't allow the electric heat to come on as second stage heating unless the outdoor temperature is below the set point of the outdoor thermostat. This is done to maximize efficiency by utilizing the heat pump to bring the conditioned space temperature up, rather than cycling on the electric heat due a second stage call for heat from the thermostat on start-up coming off a night set-back condition or someone increasing the thermostat set point. (NOTE: Some programmable thermostats do have a built-in time delay for pulling in second stage heat when coming off set-back conditions.)

**FIGURE 12  
ELECTRIC HEAT HOLD-OFF WIRING  
4 – 10KW 1 PH – 6 & 9KW 3 PH**

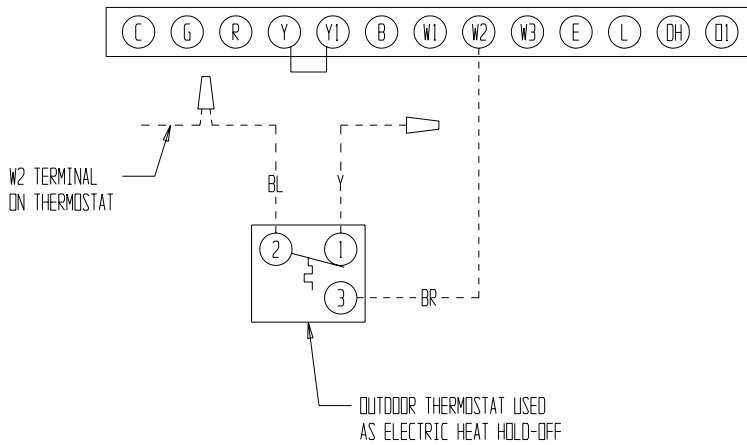

**FIGURE 13  
ELECTRIC HEAT HOLD-OFF WIRING  
15 – 20KW 1 PH AND 3 PH**

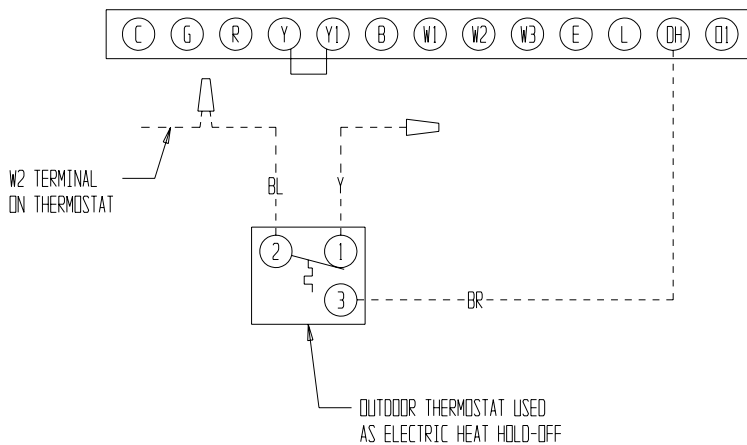



**TABLE 4  
WALL THERMOSTAT**

<b>Thermostat</b>	<b>Predominant Features</b>
8403-058 (TH5220D1151)	2 stage cool; 2 stage heat Electronic Non-Programmable Auto or Manual changeover
8403-060 (1120-445)	3 stage Cool; 3 stage Heat Programmable/Non-Programmable Electronic HP or Conventional Auto or Manual changeover

# START UP

---

## IMPORTANT INSTALLER NOTE

For improved start up performance wash the indoor coil with a dish washing detergent.

## CRANKCASE HEATERS

WH612-B and -C are provided with compressor crankcase heat. All other models are not provided with crankcase heat. They are either single phase or the system refrigerant charge is not of sufficient quantity to require crankcase heat.

The WH612-B and -C models have a wrap around type heater located on the lower section of the compressor housing. This is an on/off heater that is controlled by the compressor contactor.

The label in Figure 14 is affixed to all WH612-B and -C units detailing start up procedure. This is *very* important. *Please read carefully.*

## HIGH PRESSURE SWITCH

All models are supplied with a remote reset high pressure switch. If tripped, this pressure switch may be reset by turning the thermostat off then back on again.

## TWO SPEED OUTDOOR FAN MOTORS

All units have two speed outdoor fan motors.

The two speed outdoor fan motor is controlled with an outdoor thermostat and operates on low speed below 80°F outdoor temperature in cooling mode. In heating mode it operates on high speed only.

## THREE PHASE SCROLL COMPRESSOR START UP INFORMATION

Scroll compressors, like several other types of compressors, will only compress in one rotational direction. Direction of rotation is not an issue with single phase compressors since they will always start and run in the proper direction.

However, three phase compressors will rotate in either direction depending upon phasing of the power. Since there is a 50-50 chance of connecting power in such a way as to cause rotation in the reverse direction, verification of proper rotation must be made. All three phase units incorporate a phase monitor to ensure proper field wiring. See the "Phase Monitor" section later in this manual.

Verification of *proper rotation* must be made any time a compressor is changed or rewired. If improper rotation is corrected at this time there will be no negative impact on the durability of the compressor.

FIGURE 14  
START UP LABEL

### IMPORTANT

These procedures must be followed at initial start up and at any time power has been removed for 12 hours or longer.

To prevent compressor damage which may result from the presence of liquid refrigerant in the compressor crankcase:

1. Make certain the room thermostat is in the "off" position. (The compressor is not to operate.)
2. Apply power by closing the system disconnect switch. This energizes the compressor heater which evaporates the liquid refrigerant in the crankcase.
3. Allow 4 hours or 60 minutes per pound of refrigerant in the system as noted on the unit rating plate, whichever is greater.
4. After proper elapsed time the thermostat may be set to operate the compressor.
5. Except as required for safety while servicing, **do not open system disconnect switch.**

7961-411

However, reverse operation for over one hour may have a negative impact on the bearing due to oil pump out.

*NOTE: If compressor is allowed to run in reverse rotation for several minutes, the compressor's internal protector will trip.*

All three phase ZR3 compressors are wired identically internally. As a result, once the correct phasing is determined for a specific system or installation, connecting properly phased power leads to the same Fusite terminal should maintain proper rotation direction.

Verification of proper rotation direction is made by observing that suction pressure drops and discharge pressure rises when the compressor is energized. Reverse rotation also results in an elevated sound level over that with correct rotations, as well as, substantially reduced current draw compared to tabulate values.

The direction of rotation of the compressor may be changed by reversing any two line connections to the unit.

## PHASE MONITOR

All units with three phase compressors are equipped with a 3 phase line monitor to prevent compressor damage due to phase reversal.

The phase monitor in this unit is equipped with two LEDs. If the Y signal is present at the phase monitor and phases are correct, the green LED will light. If phases are reversed, the red fault LED will be lit and compressor operation is inhibited.

If a fault condition occurs, reverse two of the supply leads to the unit. Do not reverse any of the unit factory wires as damage may occur.

## SERVICE HINTS

1. Caution owner/operator to maintain clean air filters at all times. Also, not to needlessly close off supply and return air registers. This reduces airflow through the system, which shortens equipment service life as well as increasing operating costs.
2. Switching to heating cycle at 75°F or higher outside temperature may cause a nuisance trip of the remote reset high pressure switch. Turn thermostat off then on to reset the high pressure switch.
3. The heat pump wall thermostats perform multiple functions. Be sure that all function switches are correctly set for the desired operating mode before trying to diagnose any reported service problems.
4. Check all power fuses or circuit breakers to be sure they are the correct rating.
5. Periodic cleaning of the outdoor coil to permit full and unrestricted airflow circulation is essential.

## SEQUENCE OF OPERATION

**COOLING** – Circuit R-Y makes at thermostat pulling in compressor contactor, starting the compressor and outdoor motor. The G (indoor motor) circuit is automatically completed on any call for cooling operation or can be energized by manual fan switch on subbase for constant air circulation.

**HEATING** – A 24V solenoid coil on reversing valve controls heating cycle operation. Two thermostat options, one allowing “Auto” changeover from cycle to cycle and the other constantly energizing solenoid coil during heating season and thus eliminating pressure equalization noise except during defrost, are to be used. On “Auto” option a circuit is completed from R-W1 and R-Y on each heating “on” cycle, energizing reversing valve solenoid and pulling in compressor contactor starting compressor and outdoor motor. R-G also make starting indoor blower motor. Heat pump heating cycle now in operation.

The second option has no “Auto” changeover position, but instead energizes the reversing valve solenoid constantly whenever the system switch on subbase is placed in “Heat” position, the “B” terminal being constantly energized from R. A thermostat demand for heat completes R-Y circuit, pulling in compressor contactor starting compressor and outdoor motor. R-G also make starting indoor blower motor.

## PRESSURE SERVICE PORTS

High and Low pressure service ports are installed on all units so that the system operating pressures can be observed. Pressure tables can be found later in the manual covering all models on both cooling and heating cycles. It is imperative to match the correct pressure table to the unit by model number.

## DEFROST CYCLE

The defrost cycle is controlled by temperature and time on the solid state heat pump control. See Figure 15.

When the outdoor temperature is in the lower 40°F temperature range or colder, the outdoor coil temperature is 32°F or below. This coil temperature is sensed by the coil temperature sensor mounted near the bottom of the outdoor coil. Once coil temperature reaches 30°F or below, the coil temperature sensor sends a signal to the control logic of the heat pump control and the defrost timer will start.

After 60 minutes at 30°F or below, the heat pump control will place the system in the defrost mode.

During the defrost mode, the refrigerant cycle switches back to the cooling cycle, the outdoor motor stops, electric heaters are energized, and hot gas passing through the outdoor coil melts any accumulated frost. When the temperature rises to approximately 57°F, the coil temperature sensor will send a signal to the heat pump control which will return the system to heating operations automatically.

If some abnormal or temporary condition such as a high wind causes the heat pump to have a prolonged defrost cycle, the heat pump control will restore the system to heating operation automatically after 10 minutes.

The heat pump defrost control board has an option of 30, 60 or 90-minute setting. All models are shipped from the factory on the 60-minute pin. If special circumstances require a change to another time, remove the wire from the 60-minute terminal and reconnect to the desired terminal. The manufacturer’s recommendation is for 60-minute defrost cycles. Refer to Figure 15.

There is a cycle speed up jumper on the control. This can be used to reduce the time between defrost cycle operation without waiting for time to elapse.

Use a small screwdriver or other metallic object, or another 1/4 inch QC, to short between the *SPEEDUP* terminals to accelerate the HPC timer and initiate defrost.

Be careful not to touch any other terminals with the instrument used to short the *SPEEDUP* terminals. It may take up to 10 seconds with the *SPEEDUP* terminals shorted for the speedup to be completed and the defrost cycle to start.

***As soon as the defrost cycle kicks in remove the shorting instrument from the SPEEDUP terminals.*** Otherwise the timing will remain accelerated and run through the 1-minute minimum defrost length sequence in a matter of seconds and will automatically terminate the defrost sequence.

There is an initiate defrost jumper (sen jump) on the control that can be used at any outdoor ambient during the heating cycle to simulate a 0° coil temperature. This can be used to check defrost operation of the unit without waiting for the outdoor ambient to fall into the defrost region.

By placing a jumper across the *SEN JMP* terminals (a 1/4 inch QC terminal works best) the defrost sensor mounted on the outdoor coil is shunted out and will activate the timing circuit. This permits the defrost cycle to be checked out in warmer weather conditions without the outdoor temperature having to fall into the defrost region.

In order to terminate the defrost test the *SEN JMP* jumper must be removed. If left in place too long the compressor could stop due to the high pressure control opening because of high pressure condition created by operating in the cooling mode with outdoor fan off. Pressure will rise fairly fast as there is likely no actual frost on the outdoor coil in this artificial test condition.

There is also a 5-minute compressor time delay function built into the HPC. This is to protect the compressor from short cycling conditions. In some instances it is helpful to the service technician to override or speed up this timing period, and shorting out the *SPEEDUP* terminals for a few seconds can do this.

**FIGURE 15  
DEFROST CONTROL BOARD**

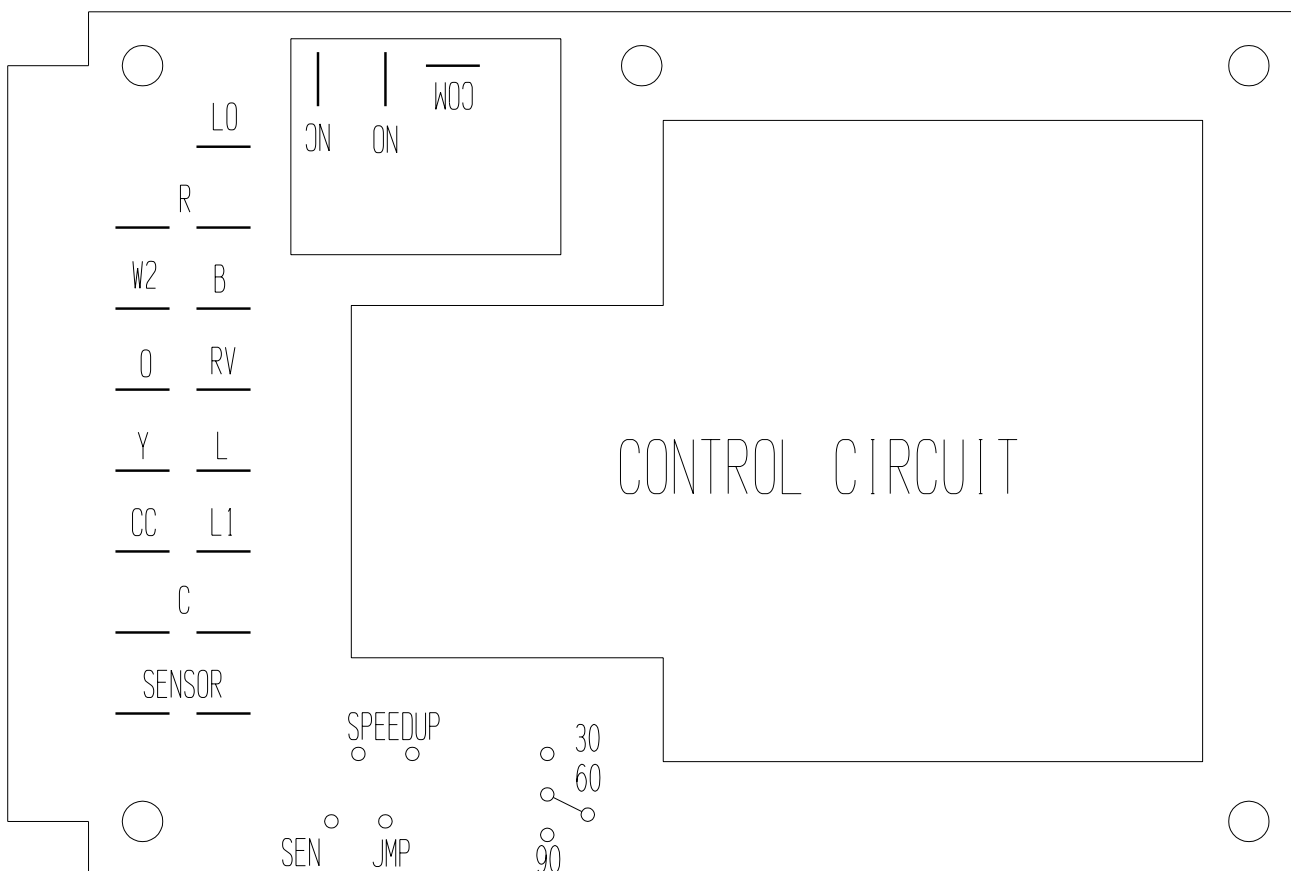

MIS-1174

# TROUBLESHOOTING

## SOLID STATE HEAT PUMP CONTROL TROUBLESHOOTING PROCEDURE

1. **NOTE:** A thorough understanding of the defrost cycle sequence is essential. Review that section earlier in this manual prior to troubleshooting the control. Turn on AC power supply to unit.
2. Turn thermostat blower switch to “fan on” – the indoor blower should start. (If it doesn’t, troubleshoot indoor unit and correct problem.)

3. Turn thermostat blower to “auto” position. Indoor blower should stop. **NOTE:** Many models have a 1-minute blower time delay on “off” command; wait for this to time-out.
4. Set system switch to “heat” or “cool”. Adjust thermostat to call for heat or cool. The indoor blower, compressor and outdoor fan should start.

*NOTE: If there was no power to 24 volt transformer, the compressor and outdoor fan motor will not start for 5 minutes. This is because of the compressor short cycle protection.*

**TABLE 5  
TROUBLESHOOTING**

Symptom	Possible Causes	What & How to Check / Repair
Compressor will not start (heating or cooling)	Check for 24V from R to C on the heat pump control	If 24V is not present at R, check wiring from board to transformer and check transformer input and output voltage. If transformer has no 24V output, determine cause and replace transformer.
	Check for 24V from Y to C on low voltage terminal strip	If 24V is not present, check thermostat and thermostat wiring, outdoor thermostat (if equipped) phase monitor (if equipped, used on some 3-phase models). If 24V is present continue to next step.
	Check for 24V from C to CC on heat pump control	If 24V is present, check and/or replace compressor contactor. If 24V is not present, jump the speed up terminal for 10 seconds. If compressor does not start check for 24V from C to L1 on the heat pump control.
	Compressor lock out	If 24V is not present at L1 of the heat pump control, check the high pressure switch and low pressure bypass relay (if equipped) and all associated wiring and terminals. The safety circuit is a closed circuit. If the high pressure switch or low pressure bypass relay are open, the control will lock out the compressor. Replace defective component. Cycle power off and on to reset lock out. Jump speed up terminals for 10 seconds to override 5-minute time delay.
	Defective heat pump control	If 24V is present from C to Y, and C to L1 on the heat pump control, the time delay has been overridden or expired and no 24V is present at CC, replace the heat pump control.
Fan outdoor motor does not run (cooling or heating except during defrost)	Heat pump control defective	Check across fan relay on heat pump control. (Com-NC) Replace heat pump control.
	Motor defective	Check for open or shorted motor winding. Replace motor.
	Motor capacitor defective	Check capacitor rating. Check for open or shorted capacitor. Replace capacitor.
Reversing valve does not energize (heating only)	Heat pump control defective	Check for 24V between RV-C and B-C. 1. Check control circuit wiring. 2. Replace heat pump control
	Reversing valve solenoid coil defective	Check for open or shorted coil. Replace solenoid coil.
Unit will not go into defrost (heating only)	Temperature sensor or heat pump control defective	Disconnect temperature sensor from board and jumper across "SPEEDUP" terminals and "SEN JMP" terminals. This should cause the unit to go through a defrost cycle within one minute. 1. If unit goes through defrost cycle, replace temperature sensor. 2. If unit does not go through defrost cycle, replace heat pump control.
Unit will not come out of defrost (heating only)	Temperature sensor or heat pump control defective.	Jumper across "SPEEDUP" terminal. This should cause the unit to come out of defrost within one minute. 1. If unit comes out of defrost cycle, replace temperature sensor. 2. If unit does not come out of defrost cycle, replace heat pump control.

## CHECKING TEMPERATURE SENSOR OUTSIDE UNIT CIRCUIT

1. Disconnect temperature sensor from board and from outdoor coil.
2. Use an ohmmeter and measure the resistance of the sensor. Also use ohmmeter to check for short or open.
3. Check resistance reading to chart of resistance use sensor ambient temperature. (Tolerance of part is  $\pm 10\%$ )
4. If sensor resistance reads very low, then sensor is shorted and will not allow proper operation of the heat pump control.
5. If sensor is out of tolerance, shorted, open, or reads very low ohms then it should be replaced.

**TEMPERATURE F VS RESISTANCE R OF TEMPERATURE**

F	R	F	R	F	R
-25.0	196871	25.0	39898	75.0	10501
-24.0	190099	26.0	38757	76.0	10247
-23.0	183585	27.0	37652	77.0	10000
-22.0	177318	28.0	36583	78.0	9760
-21.0	171289	29.0	35548	79.0	9526
-20.0	165487	30.0	34545	80.0	9299
-19.0	159904	31.0	33574	81.0	9077
-18.0	154529	32.0	32634	82.0	8862
-17.0	149355	33.0	31723	83.0	8653
-16.0	144374	34.0	30840	84.0	8449
-15.0	139576	35.0	29986	85.0	8250
-14.0	134956	36.0	29157	86.0	8057
-13.0	130506	37.0	28355	87.0	7869
-12.0	126219	38.0	27577	88.0	7686
-11.0	122089	39.0	26823	89.0	7507
-10.0	118108	40.0	26092	90.0	7334
-9.0	114272	41.0	25383	91.0	7165
-8.0	110575	42.0	24696	92.0	7000
-7.0	107010	43.0	24030	93.0	6840
-6.0	103574	44.0	23384	94.0	6683
-5.0	100260	45.0	22758	95.0	6531
-4.0	97064	46.0	22150	96.0	6383
-3.0	93981	47.0	21561	97.0	6239
-2.0	91008	48.0	20989	98.0	6098
-1.0	88139	49.0	20435	99.0	5961
0.0	85371	50.0	19896	100.0	5827
1.0	82699	51.0	19374	101.0	5697
2.0	80121	52.0	18867	102.0	5570
3.0	77632	53.0	18375	103.0	5446
4.0	75230	54.0	17898	104.0	5326
5.0	72910	55.0	17434	105.0	5208
6.0	70670	56.0	16984	106.0	5094
7.0	68507	57.0	16547	107.0	4982
8.0	66418	58.0	16122	108.0	4873
9.0	64399	59.0	15710	109.0	4767
10.0	62449	60.0	15310	110.0	4663
11.0	60565	61.0	14921	111.0	4562
12.0	58745	62.0	14544	112.0	4464
13.0	56985	63.0	14177	113.0	4367
14.0	55284	64.0	13820	114.0	4274
15.0	53640	65.0	13474	115.0	4182
16.0	52051	66.0	13137	116.0	4093
17.0	50514	67.0	12810	117.0	4006
18.0	49028	68.0	12492	118.0	3921
19.0	47590	69.0	12183	119.0	3838
20.0	46200	70.0	11883	120.0	3757
21.0	44855	71.0	11591	121.0	3678
22.0	43554	72.0	11307	122.0	3601
23.0	42295	73.0	11031	123.0	3526
24.0	41077	74.0	10762	124.0	3452

## FAN BLADE SETTING DIMENSIONS

Shown in Figure 16 are the correct fan blade setting dimensions for proper air delivery across the outdoor coil.

Any service work requiring removal or adjustment in the fan and/or motor area will require that the dimensions below be checked and blade adjusted in or out on the motor shaft accordingly.

**FIGURE 16  
FAN BLADE SETTING**

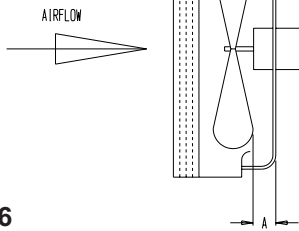

**TABLE 6  
FAN BLADE  
SETTING DIMENSION**

Model	Dimension A
WH612	1.00"

## REMOVAL OF FAN SHROUD

1. Disconnect all power to the unit.
2. Remove the screws holding both grilles, one on each side of unit, and remove grilles.
3. Remove screws holding fan shroud to condenser and bottom. Nine (9) screws.
4. Unwire condenser fan motor.
5. Slide complete motor, fan blade, and shroud assembly out the left side of the unit.
6. Service motor/fan as needed.
7. Reverse steps to reinstall.

## REFRIGERANT CHARGE

The correct system R-22 charge is shown on the unit rating plate. Optimum unit performance will occur with a refrigerant charge shown on the unit serial plate.

If correct charge is in doubt, recover the refrigerant and recharge per the charge on the unit rating plate. See Table 7 for proper subcooling levels for evaluation of proper charge.

**TABLE 7 ①  
REFRIGERANT CHARGE  
SUBCOOLING LEVEL**

Model	Rated Airflow	COOLING		HEATING	
		95 OD Temperature	82 OD Temperature	47 OD Temperature	17 OD Temperature
WH612	1350	18 - 21	16 - 19	9 - 13	10 - 14

- ① Expected subcooling levels during cooling operation. Above subcooling levels are provided to troubleshoot low charge or overcharged conditions. If charge is in doubt, evacuate and recharge the unit to the refrigerant charge listed on the serial plate.

**TABLE 8  
RATED CFM & RATED ESP**

Model	Rated CFM *	Rated ESP *	Recommended Airflow Range
WH612	1350	.20	1475 -- 1100

\* Rated CFM and ESP on high speed tap.

**TABLE 9  
INDOOR BLOWER PERFORMANCE  
CFM @ 230V / 460V**

E.S.P. In H <sub>2</sub> O	WH612			
	High Speed		Low Speed	
	Dry Coil	Wet Coil	Dry Coil	Wet Coil
.0	1800	1550	1600	1350
.1	1700	1450	1500	1250
.2	1600	1350	1400	1150
.3	1500	1250	1325	1075
.4	---	---	---	---

Subtract .08 static for 2" filter

**NOTE: WH612 is shipped with the indoor blower on low speed. Move to high speed for high static applications.**

**TABLE 10  
MAXIMUM ESP OF OPERATION**

	High Speed	Low Speed
A05	.3	.3
A08	.3	.3
A10	.3	.3
A20	.3	.3
B09	.3	.3
C09	.3	.3



**TABLE 11  
PRESSURE TABLE**

**COOLING**

Air Temperature Entering Outdoor Coil °F

Model	Return Air Temperature	Pressure	75	80	85	90	95	100	105	110	115
WH612	75 deg. DB 62 deg. WB	Low Side	67	69	70	72	73	75	76	76	77
		High Side	186	203	219	236	254	272	291	310	330
	80 deg. DB 67 deg. WB	Low Side	72	74	75	77	78	80	81	81	82
		High Side	191	208	225	242	261	279	298	318	338
	85 deg. DB 72 deg. WB	Low Side	75	77	78	80	81	83	84	84	85
		High Side	198	215	233	250	270	289	308	329	350

Low side pressure ± 2 PSIG

High side pressure ± 5 PSIG

Tables are based upon rated CFM (airflow) across the evaporator coil. If there is any doubt as to correct operating charge being in the system, the charge should be removed, system evacuated and recharged to serial plate instruction.

**TABLE 12  
PRESSURE TABLE**

**HEATING**

Air Temperature Entering Outdoor Coil °F

Model	Return Air Temperature	Pressure	0	5	10	15	20	25	30	35	40	45	50	55	60
WH612	70 deg.	Low Side	16	19	21	24	28	32	36	41	46	51	57	64	71
		High Side	187	189	192	197	204	211	221	232	244	258	273	290	308

Low side pressure ± 2 PSIG

High side pressure ± 5 PSIG

Tables are based upon rated CFM (airflow) across the evaporator coil. If there is any doubt as to correct operating charge being in the system, the charge should be removed, system evacuated and recharged to serial plate instruction.