INSTALLATION INSTRUCTIONS

WALL MOUNTED PACKAGE AIR CONDITIONERS

MODELS

WA381

WA423

WA484

WA491

WA605



Climate Control Solutions

Bard Manufacturing Company, Inc.
Bryan, Ohio 43506
Since 1914...Moving ahead just as planned.

Manual : 2100-503
Supersedes: *NEW*
File: Volume III Tab 16
Date: 01-31-08

Contents

Getting Other Information and Publications 3

Wall Mount General Information

Wall Mount Model Nomenclature	4
Shipping Damage	7
General	7
Duct Work	8
Filters	8
Fresh Air Intake	8
Condensate Drain	8

Installation Instructions

Wall Mounting Information	9
Mounting the Unit	9
Wiring – Main Power	14
Wiring – Low Voltage Wiring	14

Figures

Figure 1 Unit Dimensions	5
Figure 2 Fresh Air Damper Assembly	8
Figure 3 Mounting Instructions	10
Figure 4 Electric Heat Clearance	11
Figure 5 Wall Mounting Instructions	12
Figure 6 Wall Mounting Instructions	12
Figure 7 Common Wall Mounting Installations	13
Figure 8 Unit 24V Terminal Board	15
Figure 9 Fan Blade Setting	18

Start Up

Important Installer Note	16
High Pressure Switch	16
Three Phase Scroll Compressor Start Up	16
Phase Monitor	16
Condenser Fan Operation	16
Service Hints	16
Sequence of Operation	17
Compressor Control Module	17
Adjustments	17
Pressure Service Ports	17

Troubleshooting

Fan Blade Setting Dimensions	18
Removal of Fan Shroud	18
Refrigerant Charge	18
Pressure Table – Cooling	20
Optional Accessories	21

Tables

Table 1 Electric Heat Table	4
Table 2 Electrical Specifications	6 and 7
Table 3 Thermostat Wire Size	14
Table 4 Wall Thermostat	14
Table 5 Fan Blade Dimensions	18
Table 6 Refrigerant Charge	18
Table 7 Indoor Blower Performance	18
Table 7A Indoor Blower Performance	19
Table 8 Recommended Airflow	19
Table 9 Maximum ESP Electric Heat Only	19
Table 9A Maximum ESP Electric Heat Only	19
Table 10 Pressure Table	20
Table 11 Optional Accessories	21

GETTING OTHER INFORMATION AND PUBLICATIONS

These publications can help you install the air conditioner or heat pump. You can usually find these at your local library or purchase them directly from the publisher. Be sure to consult current edition of each standard.

National Electrical Code ANSI/NFPA 70

Standard for the Installation ANSI/NFPA 90A
of Air Conditioning and Ventilating Systems

Standard for Warm Air ANSI/NFPA 90B
Heating and Air Conditioning Systems

Load Calculation for ACCA Manual J
Residential Winter and Summer Air Conditioning

Duct Design for Residential ACCA Manual D
Winter and Summer Air Conditioning and Equipment
Selection

FOR MORE INFORMATION, CONTACT THESE PUBLISHERS:

ACCA **Air Conditioning Contractors of America**
1712 New Hampshire Ave. N.W.
Washington, DC 20009
Telephone: (202) 483-9370
Fax: (202) 234-4721

ANSI **American National Standards Institute**
11 West Street, 13th Floor
New York, NY 10036
Telephone: (212) 642-4900
Fax: (212) 302-1286

ASHRAE **American Society of Heating, Refrigeration
and Air Conditioning Engineers, Inc.**
1791 Tullie Circle, N.E.
Atlanta, GA 30329-2305
Telephone: (404) 636-8400
Fax: (404) 321-5478

NFPA **National Fire Protection Association**
Batterymarch Park
P.O. Box 9101
Quincy, MA 02269-9901
Telephone: (800) 344-3555
Fax: (617) 984-7057

WALL MOUNT GENERAL INFORMATION

AIR CONDITIONER WALL MOUNT MODEL NOMENCLATURE

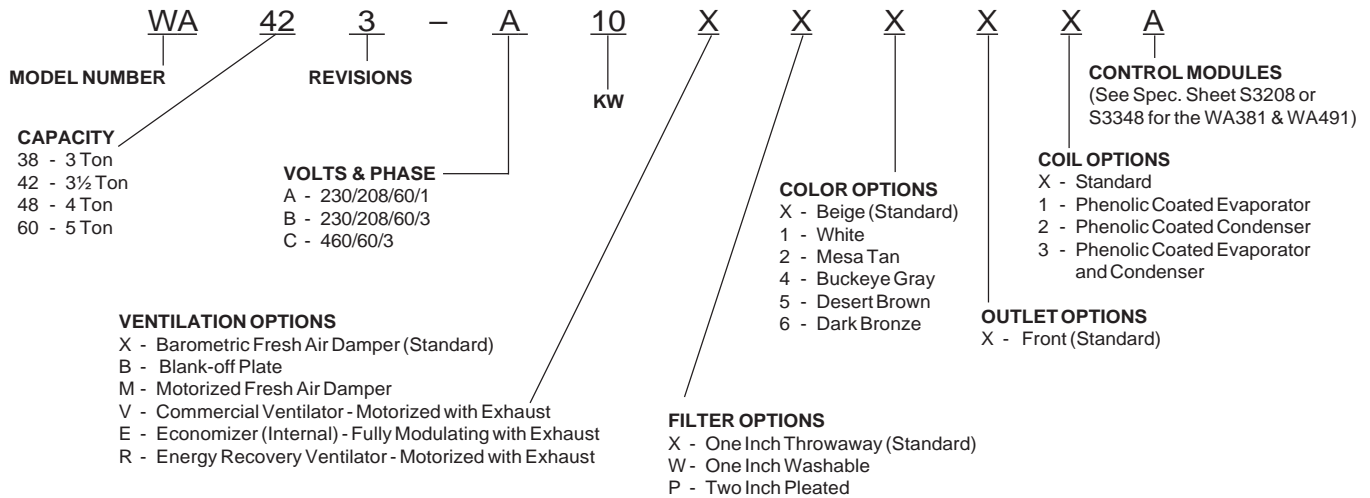

NOTE: All vent options are without exhaust capability. May require separate field supplied barometric relief in building.

**TABLE 1
ELECTRIC HEAT TABLE**

Models	WA381-A WA423-A WA484-A WA491-A WA605-A				WA381-B WA423-B WA484-B WA491-B WA605-B				WA381-C WA423-C WA484-C WA491-C WA605-C	
	230-1		208-1		230-3		208-3		460-3	
	KW	A	BTU	A	BTU	A	BTU	A	BTU	A
5	20.8	17050	18.1	12800	---	---	---	---	---	---
6	---	---	---	---	14.4	20500	12.5	15360	7.2	20480
8	33.3	27280	28.8	20450	---	---	---	---	---	---
9	---	---	---	---	21.7	30600	18.7	23030	10.8	30700
10	41.6	34130	36.2	25600	---	---	---	---	---	---
15	62.5	51200	54.0	38400	36.2	51200	31.2	38400	17.3	47000
18	---	---	---	---	43.3	61430	37.5	46100	---	---
20	83.2	68260	72.1	51200	---	---	---	---	---	---

**FIGURE 1
UNIT DIMENSIONS**

Model	Width (W)	Depth (D)	Height (H)	Supply		Return		E	F	G	I	J	K	L	M	N	O	P	Q	R	S	T	
				A	B	C	B																
WA38																							
WA42																							
WA48	42.075	22.432	84.875	9.88	29.88	15.88	29.88	43.88	19.10	31.66	30.00	32.68	26.94	34.69	32.43	3.37	42.88	23.88	10.00	1.44	16.00	1.88	
WA49																							
WA60																							

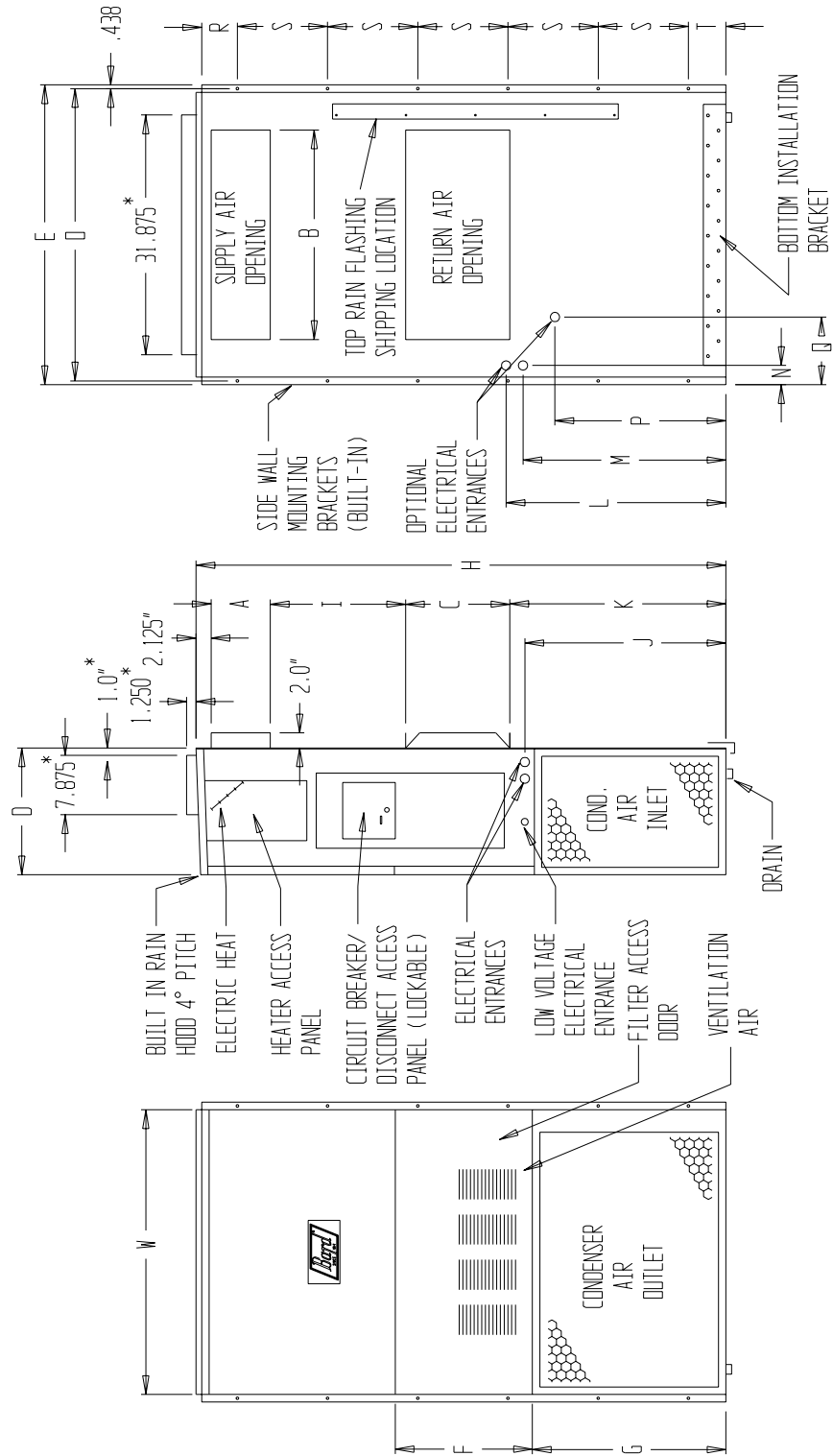

MIS-1262

BACK VIEW

SIDE VIEW

FRONT VIEW

**TABLE 2
ELECTRICAL SPECIFICATIONS**

Model	SINGLE CIRCUIT						DUAL CIRCUIT							
	Rated Volts & Phase	No. Field Power Circuits	③	①	②	②	③		①		②		②	
			Minimum Circuit Ampacity	Maximum External Fuse or Circuit Breaker	Field Power Wire Size	Ground Wire Size	Minimum Circuit Ampacity	Maximum External Fuse or Circuit Breaker	Field Power Wire Size	Ground Wire Size	CKT A	CKT B	CKT A	CKT B
WA381-A00, A0Z A05 A08 A10	230/208-1	1	25	35	8	10	N/A	N/A	N/A	N/A	N/A	N/A	N/A	N/A
		1	32	35	8	10	N/A	N/A	N/A	N/A	N/A	N/A	N/A	N/A
		1	47	50	8	10	N/A	N/A	N/A	N/A	N/A	N/A	N/A	N/A
		1	58	60	6	10	N/A	N/A	N/A	N/A	N/A	N/A	N/A	N/A
WA381-B00, B0Z B06 B09	230/208-3	1	20	30	10	10	N/A	N/A	N/A	N/A	N/A	N/A	N/A	N/A
		1	24	30	10	10	N/A	N/A	N/A	N/A	N/A	N/A	N/A	N/A
		1	33	35	8	10	N/A	N/A	N/A	N/A	N/A	N/A	N/A	N/A
WA381-C00, C0Z C06 C09	460-3	1	11	15	14	14	N/A	N/A	N/A	N/A	N/A	N/A	N/A	N/A
		1	13	15	14	14	N/A	N/A	N/A	N/A	N/A	N/A	N/A	N/A
		1	17	20	12	12	N/A	N/A	N/A	N/A	N/A	N/A	N/A	N/A
WA423-A00, A0Z A05 A10 A15 A20	230/208-1	1	35	50	8	10	N/A	N/A	N/A	N/A	N/A	N/A	N/A	N/A
		1	35	50	8	10	N/A	N/A	N/A	N/A	N/A	N/A	N/A	N/A
		1	59	60	6	10	N/A	N/A	N/A	N/A	N/A	N/A	N/A	N/A
		1 or 2	85	90	4	8	56	26	60	30	6	10	10	10
		1 or 2	110	110	2	6	56	52	60	60	6	6	10	10
WA423-B00, B0Z B09 B15 B18	230/208-3	1	24	35	8	10	N/A	N/A	N/A	N/A	N/A	N/A	N/A	N/A
		1	34	35	8	10	N/A	N/A	N/A	N/A	N/A	N/A	N/A	N/A
		1	52	50	6	10	N/A	N/A	N/A	N/A	N/A	N/A	N/A	N/A
		1	60	60	6	10	N/A	N/A	N/A	N/A	N/A	N/A	N/A	N/A
WA423-C00, C0Z C09 C15	460-3	1	13	15	14	14	N/A	N/A	N/A	N/A	N/A	N/A	N/A	N/A
		1	17	20	12	12	N/A	N/A	N/A	N/A	N/A	N/A	N/A	N/A
		1	26	30	10	10	N/A	N/A	N/A	N/A	N/A	N/A	N/A	N/A
WA484-A00, A0Z A05 A10 A15 A20	230/208-1	1	36	50	8	10	N/A	N/A	N/A	N/A	N/A	N/A	N/A	N/A
		1	36	50	8	10	N/A	N/A	N/A	N/A	N/A	N/A	N/A	N/A
		1	59	60	6	10	N/A	N/A	N/A	N/A	N/A	N/A	N/A	N/A
		1 or 2	85	90	4	8	59	26	60	30	6	10	10	10
		1 or 2	110	110	2	6	59	52	60	60	6	6	10	10
WA484-B00, B0Z B09 B15 B18	230/208-3	1	25	35	8	10	N/A	N/A	N/A	N/A	N/A	N/A	N/A	N/A
		1	34	35	8	10	N/A	N/A	N/A	N/A	N/A	N/A	N/A	N/A
		1	52	60	6	10	N/A	N/A	N/A	N/A	N/A	N/A	N/A	N/A
		1	60	60	6	10	N/A	N/A	N/A	N/A	N/A	N/A	N/A	N/A
WA484-C00, C0Z C09 C15	460-3	1	13	15	14	14	N/A	N/A	N/A	N/A	N/A	N/A	N/A	N/A
		1	17	20	12	12	N/A	N/A	N/A	N/A	N/A	N/A	N/A	N/A
		1	26	30	10	10	N/A	N/A	N/A	N/A	N/A	N/A	N/A	N/A
WA491-A00, A0Z A05 A08 A10	230/208-1	1	33	50	8	10	N/A	N/A	N/A	N/A	N/A	N/A	N/A	N/A
		1	33	50	8	10	N/A	N/A	N/A	N/A	N/A	N/A	N/A	N/A
		1	47	50	8	10	N/A	N/A	N/A	N/A	N/A	N/A	N/A	N/A
		1	58	60	6	10	N/A	N/A	N/A	N/A	N/A	N/A	N/A	N/A
WA491-B00, B0Z B06 B09	230/208-3	1	27	40	8	10	N/A	N/A	N/A	N/A	N/A	N/A	N/A	N/A
		1	27	40	8	10	N/A	N/A	N/A	N/A	N/A	N/A	N/A	N/A
		1	33	40	8	10	N/A	N/A	N/A	N/A	N/A	N/A	N/A	N/A
WA491-C00, C0Z C06 C09	460-3	1	13	15	14	14	N/A	N/A	N/A	N/A	N/A	N/A	N/A	N/A
		1	13	15	14	14	N/A	N/A	N/A	N/A	N/A	N/A	N/A	N/A
		1	17	20	12	12	N/A	N/A	N/A	N/A	N/A	N/A	N/A	N/A

TABLE CONTINUED ON PAGE 7

- ① Maximum size of the time delay fuse or HACR type circuit breaker for protection of field wiring conductors.
- ② Based on 75°C copper wire. All wiring must conform to NEC and all local codes.
- ③ These “Minimum Circuit Ampacity” values are to be used for sizing the field power conductors. Refer to the National Electric Code (latest revision), article 310 for power conductor sizing.

CAUTION: When more than one field power conductor circuit is run through one conduit, the conductors must be derated. Pay special attention to note 8 of table 310 regarding Ampacity Adjustment Factors when more than 3 conductors are in a raceway.

TABLE CONTINUED FROM PAGE 6														
Model	SINGLE CIRCUIT						DUAL CIRCUIT							
	Rated Volts & Phase	No. Field Power Circuits	③	①	②	②	③		①		②		②	
			Minimum Circuit Ampacity	Maximum External Fuse or Circuit Breaker	Field Power Wire Size	Ground Wire Size	Minimum Circuit Ampacity	Maximum External Fuse or Circuit Breaker	Field Power Wire Size	Ground Wire Size	CKT A	CKT B	CKT A	CKT B
WA605-A00, A0Z A05 A10 A15 A20	230/208-1	1 1 1 1 or 2 1 or 2	46 46 55 85 110	60 60 60 90 110	8 8 6 4 2	10 10 10 8 6	N/A N/A N/A 59 59	N/A N/A N/A 26 52	N/A N/A N/A 60 60	N/A N/A N/A 30 60	N/A N/A N/A 6 6	N/A N/A N/A 10 6	N/A N/A N/A 10 10	N/A N/A N/A 10 10
WA605-B00, B0Z B09 B15 B18	230/208-3	1 1 1 1	32 34 52 60	45 45 60 60	8 8 6 6	10 10 10 10	N/A N/A N/A N/A	N/A N/A N/A N/A	N/A N/A N/A N/A	N/A N/A N/A N/A	N/A N/A N/A N/A	N/A N/A N/A N/A	N/A N/A N/A N/A	N/A N/A N/A N/A
WA605-C00, C0Z C09 C15	460-3	1 1 1	16 18 27	20 20 30	12 12 10	12 12 10	N/A N/A N/A	N/A N/A N/A	N/A N/A N/A	N/A N/A N/A	N/A N/A N/A	N/A N/A N/A	N/A N/A N/A	N/A N/A N/A

- ① Maximum size of the time delay fuse or HACR type circuit breaker for protection of field wiring conductors.
- ② Based on 75° C copper wire. All wiring must conform to NEC and all local codes.
- ③ These “Minimum Circuit Ampacity” values are to be used for sizing the field power conductors. Refer to the National Electric Code (latest revision), article 310 for power conductor sizing.

CAUTION: When more than one field power conductor circuit is run through one conduit, the conductors must be derated. Pay special attention to note 8 of table 310 regarding Ampacity Adjustment Factors when more than 3 conductors are in a raceway.

SHIPPING DAMAGE

Upon receipt of equipment, the carton should be checked for external signs of shipping damage. If damage is found, the receiving party must contact the last carrier immediately, preferably in writing, requesting inspection by the carrier’s agent.

GENERAL

The equipment covered in this manual is to be installed by trained, experienced service and installation technicians.

The refrigerant system is completely assembled and charged. All internal wiring is complete.

The unit is designed for use with or without duct work. Flanges are provided for attaching the supply and return ducts.

These instructions explain the recommended method to install the air cooled self-contained unit and the electrical wiring connections to the unit.

These instructions and any instructions packaged with any separate equipment required to make up the entire air conditioning system should be carefully read before beginning the installation. Note particularly “Starting Procedure” and any tags and/or labels attached to the equipment.

While these instructions are intended as a general recommended guide, they do not supersede any national and/or local codes in any way. Authorities having jurisdiction should be consulted before the installation is made. See Page 3 for information on codes and standards.

Size of unit for a proposed installation should be based on heat loss calculation made according to methods of Air Conditioning Contractors of America (ACCA). The air duct should be installed in accordance with the Standards of the National Fire Protection Association for the Installation of Air Conditioning and Ventilating Systems of Other Than Residence Type, NFPA No. 90A, and Residence Type Warm Air Heating and Air Conditioning Systems, NFPA No. 90B. Where local regulations are at a variance with instructions, installer should adhere to local codes.

DUCT WORK

All duct work, supply and return, must be properly sized for the design airflow requirement of the equipment. Air Conditioning Contractors of America (ACCA) is an excellent guide to proper sizing. All duct work or portions thereof not in the conditioned space should be properly insulated in order to both conserve energy and prevent condensation or moisture damage.

Refer to Table 9 & 9A for maximum static pressure available for duct design.

Design the duct work according to methods given by the Air Conditioning Contractors of America (ACCA). When duct runs through unheated spaces, it should be insulated with a minimum of one inch of insulation. Use insulation with a vapor barrier on the outside of the insulation. Flexible joints should be used to connect the duct work to the equipment in order to keep the noise transmission to a minimum.

A 1/4 inch clearance to combustible material for the first three feet of duct attached to the outlet air frame is required. See Wall Mounting Instructions and Figures 3 and 4 for further details.

Ducts through the walls must be insulated and all joints taped or sealed to prevent air or moisture entering the wall cavity.

Some installations may not require any return air duct. A metallic return air grille is required with installations not requiring a return air duct. The spacing between louvers on the grille shall not be larger than 5/8 inch.

Any grille that meets with 5/8 inch louver criteria may be used. It is recommended that Bard Return Air Grille Kit RG2 through RG5 or RFG2 through RFG5 be installed when no return duct is used. Contact distributor or factory for ordering information. If using a return air filter grille, filters must be of sufficient size to allow a maximum velocity of 400 fpm.

NOTE: If no return air duct is used, applicable installation codes may limit this cabinet to installation only in a single story structure.

FILTERS

A 1-inch throwaway filter is supplied with each unit. The filter slides into position making it easy to service. This filter can be serviced from the outside by removing the service door. A 1-inch washable filter and 2-inch pleated filter are also available as optional accessories. The internal filter brackets are adjustable to accommodate the 2-inch filter by loosening two (2) screws on each bracket assembly and sliding the brackets apart to the required width and retightening the four (4) screws.

FRESH AIR INTAKE

All units are built with fresh air inlet slots punched in the service door.

If the unit is equipped with a fresh air damper assembly, the assembly is shipped already attached to the unit. The damper blade is locked in the closed position. To allow the damper to operate, the maximum and minimum blade position stops must be installed. See Figure 2.

All capacity, efficiency and cost of operation information as required for Department of Energy "Energyguide" Fact Sheets is based upon the fresh air blank-off plate in place and is recommended for maximum energy efficiency.

The blank-off plate is available upon request from the factory and is installed in place of the fresh air damper shipped with each unit.

CONDENSATE DRAIN

A plastic drain hose extends from the drain pan at the top of the unit down to the unit base. There are openings in the unit base for the drain hose to pass through. In the event the drain hose is connected to a drain system of some type, it must be an open or vented type system to assure proper drainage.

**FIGURE 2
FRESH AIR DAMPER**

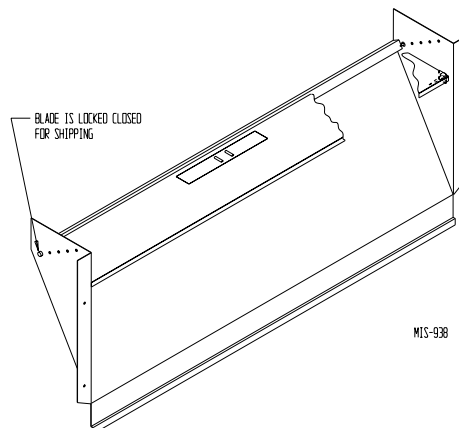

INSTALLATION INSTRUCTIONS

WALL MOUNTING INFORMATION

1. Two holes for the supply and return air openings must be cut through the wall as shown in Figure 3.
2. On wood frame walls, the wall construction must be strong and rigid enough to carry the weight of the unit without transmitting any unit vibration.
3. Concrete block walls must be thoroughly inspected to insure that they are capable of carrying the weight of the installed unit.

MOUNTING THE UNIT

1. These units are secured by wall mounting brackets which secure the unit to the outside wall surface at both sides. A bottom mounting bracket, attached to skid for shipping, is provided for ease of installation, but is not required.
2. The unit itself is suitable for 0 inch clearance, but the supply air duct flange and the first 3 feet of supply air duct require a minimum of 1/4 inch clearance to combustible material. If a combustible wall, use a minimum of 30½" x 10½" dimensions for sizing. However, it is generally recommended that a 1-inch clearance is used for ease of installation and maintaining the required clearance to combustible material. The supply air opening would then be 32" x 12". See Figures 3 and 4 for details.
3. Locate and mark lag bolt locations and bottom mounting bracket location. See Figure 3.

WARNING

Failure to provide the 1/4 inch clearance between the supply duct and a combustible surface for the first 3 feet of duct can result in fire causing damage, injury or death.

4. Mount bottom mounting bracket.
5. Hook top rain flashing, attached to front - right of supply flange for shipping, under back bend of top. Top rain flashing is shipped secured to the right side of the back.
6. Position unit in opening and secure with 5/16 lag bolts; use 7/8 inch diameter flat washers on the lag bolts.
7. Secure rain flashing to wall and caulk across entire length of top. See Figure 3.
8. For additional mounting rigidity, the return air and supply air frames or collars can be drilled and screwed or welded to the structural wall itself (depending upon wall construction). Be sure to observe required clearance if combustible wall.
9. On side-by-side installations, maintain a minimum of 20 inches clearance on right side to allow access to control panel and heat strips, and to allow proper airflow to the outdoor coil. Additional clearance may be required to meet local or national codes.

**FIGURE 3
MOUNTING INSTRUCTIONS**

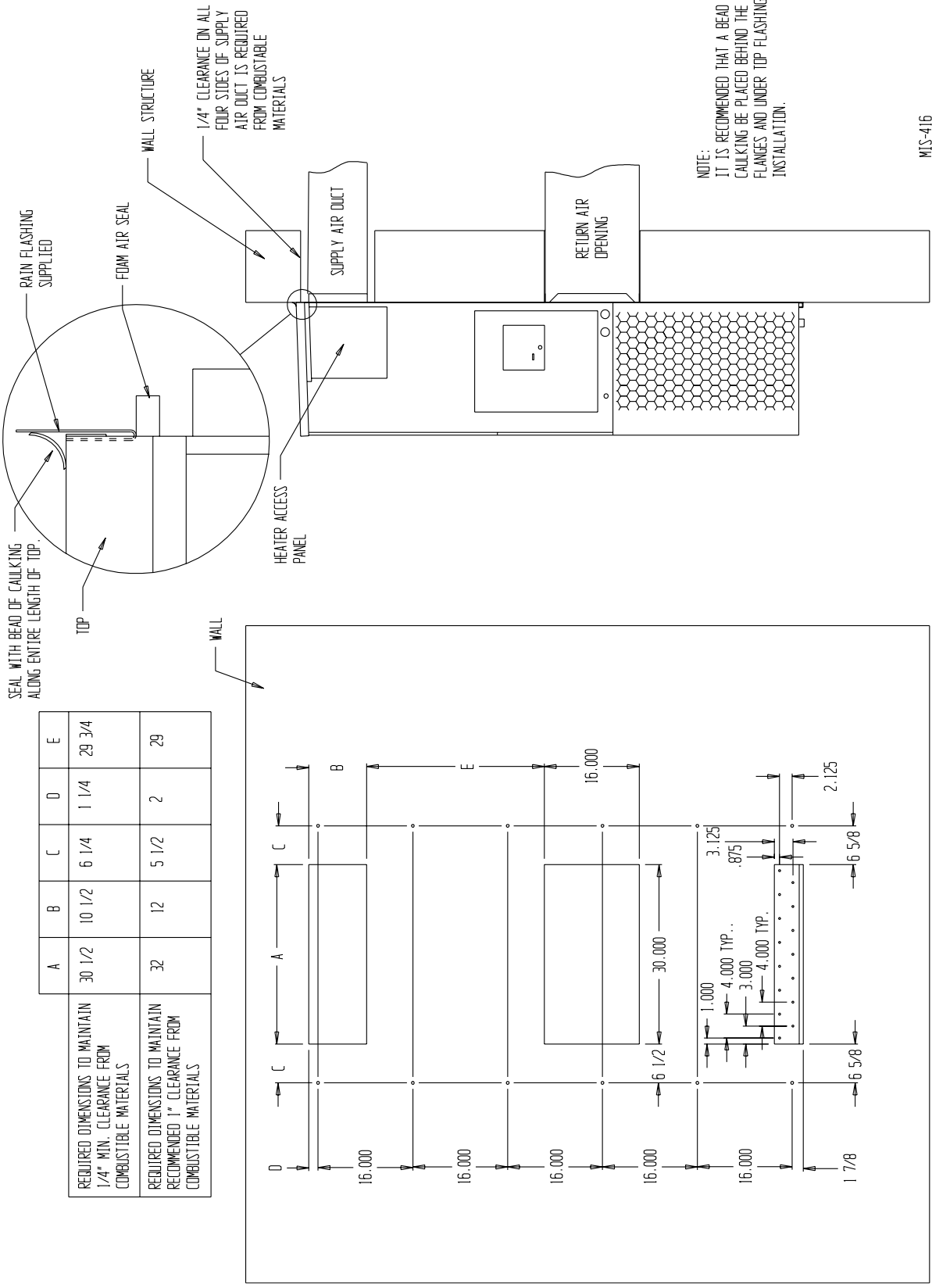

	A	B	C	D	E
REQUIRED DIMENSIONS TO MAINTAIN 1/4" MIN. CLEARANCE FROM COMBUSTIBLE MATERIALS	30 1/2	10 1/2	6 1/4	1 1/4	29 3/4
REQUIRED DIMENSIONS TO MAINTAIN RECOMMENDED 1" CLEARANCE FROM COMBUSTIBLE MATERIALS	32	12	5 1/2	2	29

NOTE:
IT IS RECOMMENDED THAT A BEAD OF SILICONE CAULKING BE PLACED BEHIND THE SIDE MOUNTING FLANGES AND UNDER TOP FLASHING AT TIME OF INSTALLATION.

MIS-416

**FIGURE 4
ELECTRIC HEAT CLEARANCE**

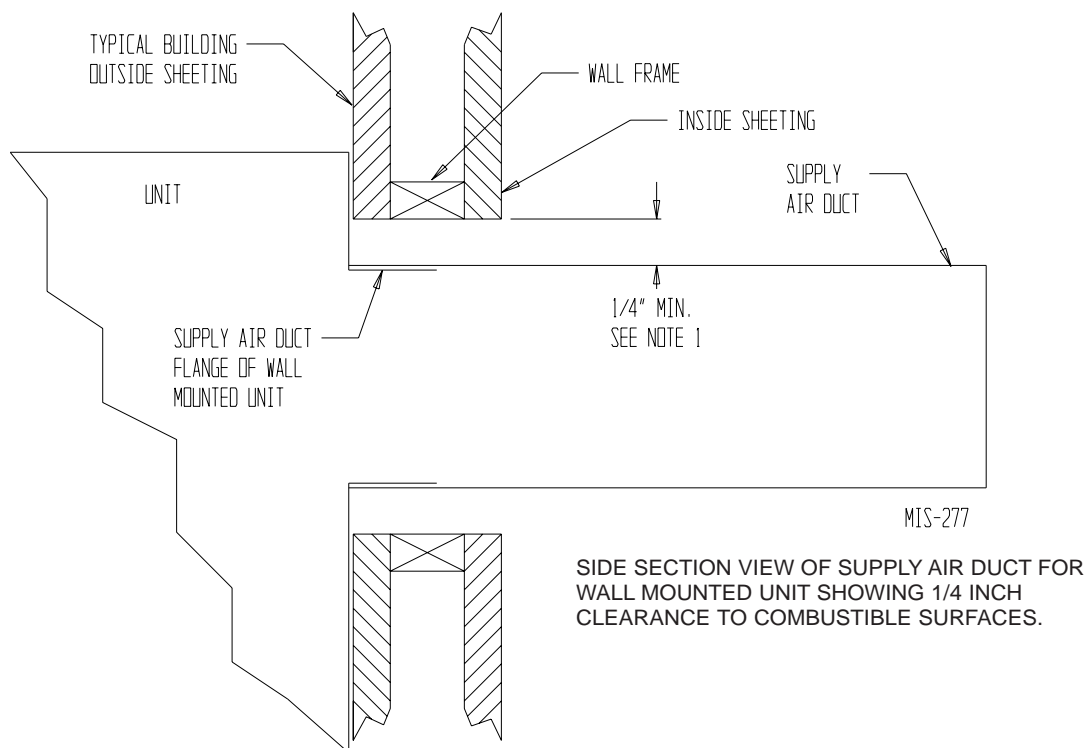

WARNING

A **minimum** of 1/4 inch clearance must be maintained between the supply air duct and combustible materials. This is required for the first 3 feet of ducting.

It is important to insure that the 1/4 inch minimum spacing is maintained at all points.

Failure to do this could result in overheating the combustible material and may result in a fire causing damage, injury or death.

FIGURE 5 WALL MOUNTING INSTRUCTIONS

SEE FIGURE 3 – MOUNTING INSTRUCTIONS

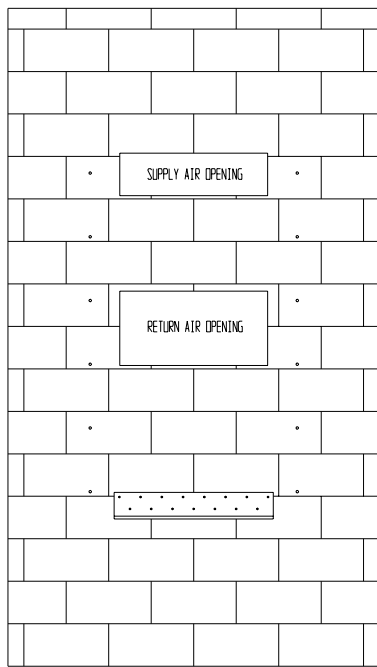

CONCRETE BLOCK WALL INSTALLATION

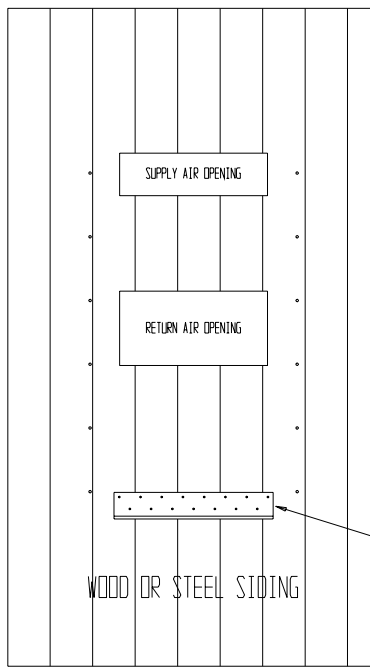

WOOD FRAME WALL INSTALLATION

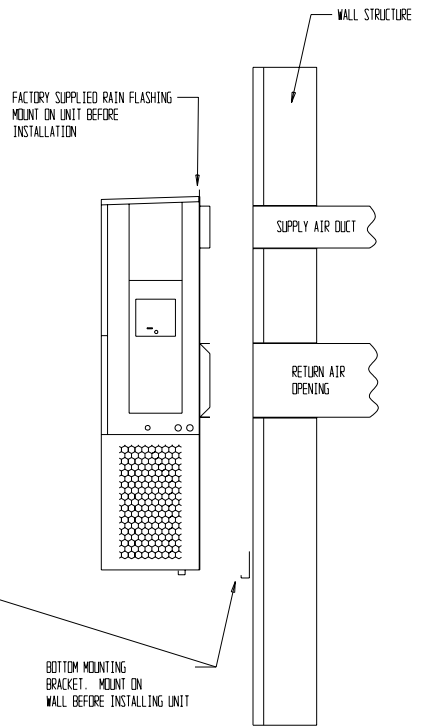

MIS-548

FIGURE 6 WALL MOUNTING INSTRUCTIONS

SEE UNIT DIMENSIONS, FIGURE 1, FOR ACTUAL DIMENSIONS

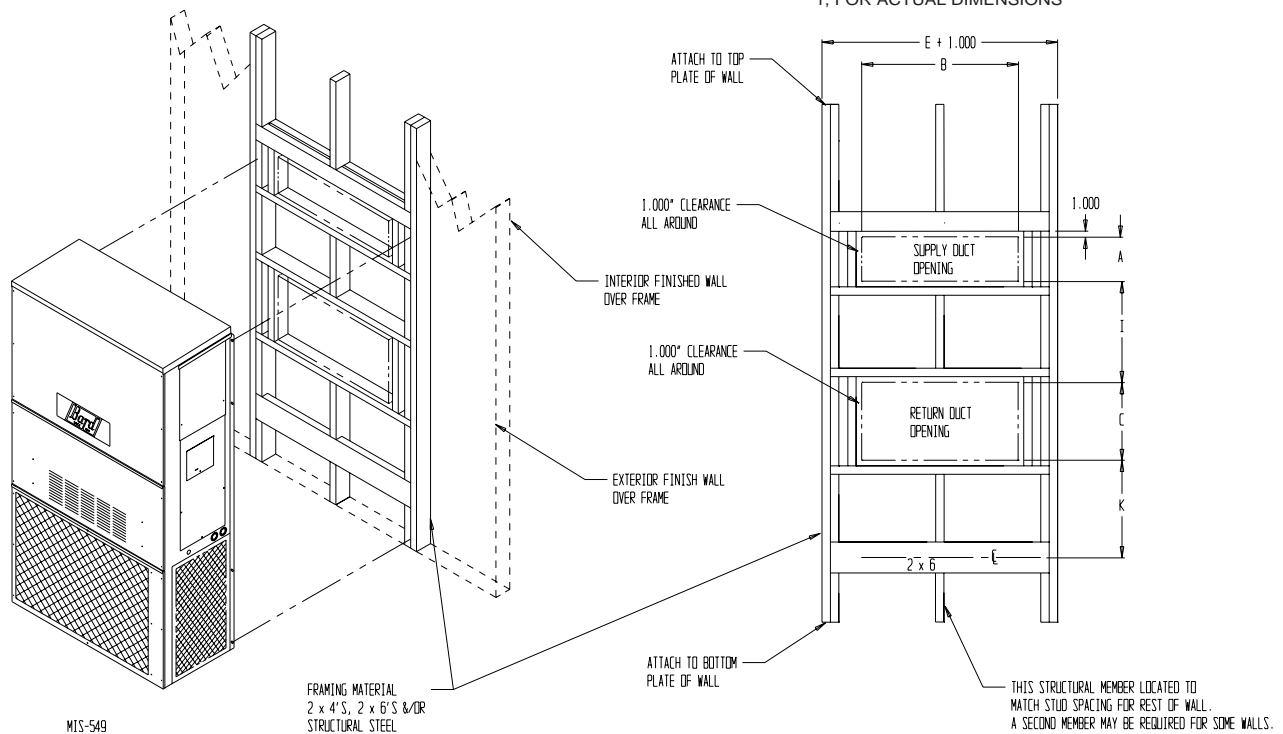

MIS-549

**FIGURE 7
COMMON WALL MOUNTING INSTALLATIONS**

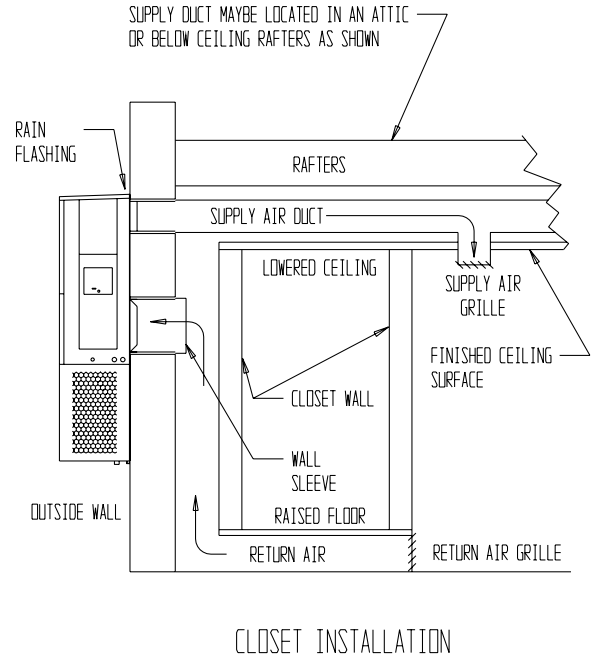
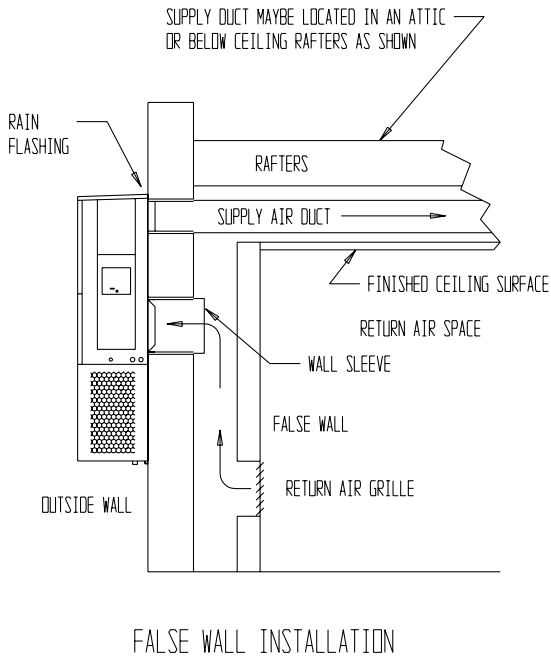
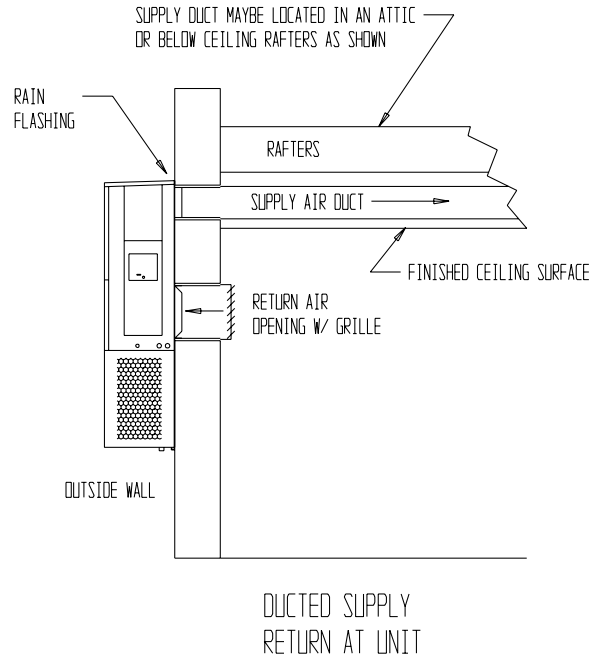
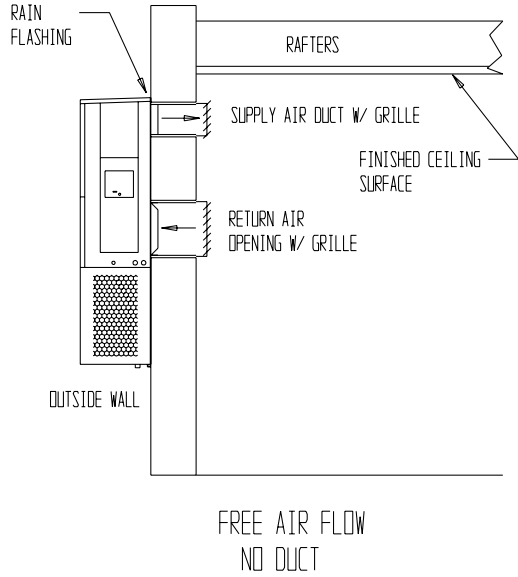

MIS-550

WIRING – MAIN POWER

Refer to the unit rating plate for wire sizing information and maximum fuse or “HACR” type circuit breaker size. Each outdoor unit is marked with a “Minimum Circuit Ampacity”. This means that the field wiring used must be sized to carry that amount of current. Depending on the installed KW of electric heat, there may be two field power circuits required. If this is the case, the unit serial plate will so indicate. All models are suitable only for connection with copper wire. Each unit and/or wiring diagram will be marked “Use Copper Conductors Only”. These instructions **must be** adhered to. Refer to the National Electrical Code (NEC) for complete current carrying capacity data on the various insulation grades of wiring material. All wiring must conform to NEC and all local codes.

The electrical data lists fuse and wire sizes (75° C copper) for all models including the most commonly used heater sizes. Also shown are the number of field power circuits required for the various models with heaters.

The unit rating plate lists a “Maximum Time Delay Relay Fuse” or “HACR” type circuit breaker that is to be used with the equipment. The correct size must be used for proper circuit protection and also to assure that there will be no nuisance tripping due to the momentary high starting current of the compressor motor.

The disconnect access door on this unit may be locked to prevent unauthorized access to the disconnect. To convert for the locking capability, bend the tab located in the bottom left-hand corner of the disconnect opening under the disconnect access panel straight out. This tab will now line up with the slot in the door. When shut, a padlock may be placed through the hole in the tab preventing entry.

See “Start Up” section for important information on three phase scroll compressor start ups.

WIRING – LOW VOLTAGE WIRING

230/208V, 1 phase and 3 phase equipment dual primary voltage transformers. All equipment leaves the factory wired on 240V tap. For 208V operation, reconnect from 240V to 208V tap. The acceptable operating voltage range for the 240 and 208V taps are:

TAP	RANGE
240	253 – 216
208	220 – 187

NOTE: The voltage should be measured at the field power connection point in the unit and while the unit is operating at full load (maximum amperage operating condition).

Five (5) to eight (8) wires should be run from thermostat subbase to the 24V terminal board in the unit, depending on the thermostat and/or controls and accessories shipped with the unit. A five or eight conductor, 18 gauge copper, color-coded thermostat cable is recommended. The connection points are shown in Figure 8.

**TABLE 3
THERMOSTAT WIRE SIZE**

Transformer VA	FLA	Wire Gauge	Maximum Distance In Feet
55	2.3	20 gauge	45
		18 gauge	60
		16 gauge	100
		14 gauge	160
		12 gauge	250

**TABLE 4
WALL THERMOSTAT**

Thermostat	Predominate Features
8403-057 TH5220D1153	1 stage Cool, 1 stage Heat Electronic Non-Programmable Auto or Manual changeover
8403-058 TH5220D1151	2 stage Cool, 2 stage Heat Electronic Non-Programmable Auto or Manual changeover
8403-060 (1120-445)	3 stage Cool; 3 stage Heat Programmable/Non-Programmable Electronic HP or Conventional Auto or Manual changeover

**FIGURE 8
UNIT 24V TERMINAL BOARD**

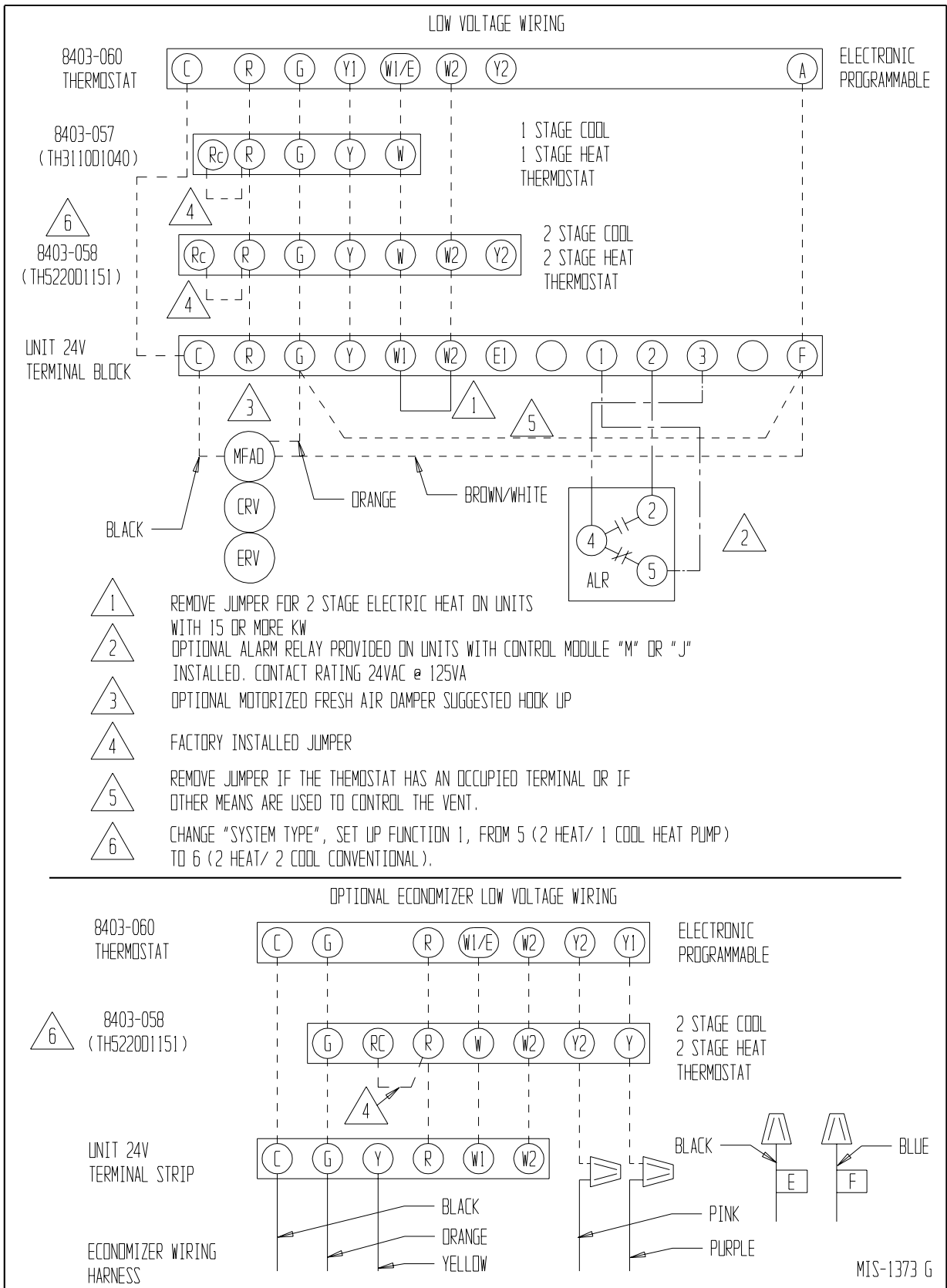

START UP

IMPORTANT INSTALLER NOTE

For improved start up performance wash the indoor coil with a dish washing detergent.

HIGH PRESSURE SWITCH

The WA381, WA484, WA491 and WA605 models are supplied with a remote reset high pressure switch. If tripped, this pressure switch may be reset by turning the thermostat off then back on again.

THREE PHASE SCROLL COMPRESSOR START UP INFORMATION

Scroll compressors, like several other types of compressors, will only compress in one rotational direction. Direction of rotation is not an issue with single phase compressors since they will always start and run in the proper direction.

However, three phase compressors will rotate in either direction depending upon phasing of the power. Since there is a 50-50 chance of connecting power in such a way as to cause rotation in the reverse direction, verification of proper rotation must be made. Verification of proper rotation direction is made by observing that suction pressure drops and discharge pressure rises when the compressor is energized. Reverse rotation also results in an elevated sound level over that with correct rotation, as well as, substantially reduced current draw compared to tabulated values.

Verification of *proper rotation* must be made at the time the equipment is put into service. If improper rotation is corrected at this time, there will be no negative impact on the durability of the compressor. However, reverse operation for over one hour may have a negative impact on the bearing due to oil pump out.

NOTE: If compressor is allowed to run in reverse rotation for several minutes, the compressor's internal protector will trip.

All three phase ZR compressors are wired identically internally. As a result, once the correct phasing is determined for a specific system or installation, connecting properly phased power leads to the same Fusite terminal should maintain proper rotation direction.

The direction of rotation of the compressor may be changed by reversing any two line connections to the unit.

PHASE MONITOR

All units with three phase scroll compressors are equipped with a 3 phase line monitor to prevent compressor damage due to phase reversal.

The phase monitor in this unit is equipped with two LEDs. If the Y signal is present at the phase monitor and phases are correct the green LED will light.

If phases are reversed, the red fault LED will be lit and compressor operation is inhibited.

If a fault condition occurs, reverse two of the supply leads to the unit. Do not reverse any of the unit factory wires as damage may occur.

CONDENSER FAN OPERATION

The condenser fan motor on 230/208 volt, one and three phase, 60 HZ units is a two-speed motor that comes factory wired on high speed for peak performance. If ambient conditions permit, it can be reconnected to low speed (red wire) for lower sound level. See wiring diagram.

50 HZ models must have fan wired on low speed. These models are factory wired on low speed.

SERVICE HINTS

1. Caution owner/operator to maintain clean air filters at all times. Also, not to needlessly close off supply and return air registers. This reduces airflow through the system, which shortens equipment service life as well as increasing operating costs.
2. Switching to heating cycle at 75°F or higher outside temperature may cause a nuisance trip of the remote reset high pressure switch. Turn thermostat off then on to reset the high pressure switch.
3. Check all power fuses or circuit breakers to be sure they are the correct rating.
4. Periodic cleaning of the outdoor coil to permit full and unrestricted airflow circulation is essential.

SEQUENCE OF OPERATION

COOLING – Circuit R-Y makes at thermostat pulling in compressor contactor, starting the compressor and outdoor motor. The G (indoor motor) circuit is automatically completed on any call for cooling operation or can be energized by manual fan switch on subbase of constant air circulation. On all 230 volt units there is a one-minute off delay on the blower motor. 460 volt models do not have an off delay. On a call for heating, circuit R-W1 make at the thermostat pulling in heat contact for the strip heat and blower operation. On a call for second stage heat, R-W2 makes bringing on second heat contactor, if so equipped.

COMPRESSOR CONTROL MODULE

The compressor control module is standard on the WA381, WA484, WA491 and WA605 models covered by this manual and is optional on the WA423 model. The compressor control is an anti-short cycle/lockout timer with high and low pressure switch monitoring and alarm relay output.

Adjustable Delay On Make And Break Timer

On initial power up or anytime power is interrupted to the unit, the *delay on make* period begins, which will be 2 minutes plus 10% of the *delay on break* setting. When the delay on make is complete and the high pressure switch (and low pressure switch if employed) is closed, the compressor contactor is energized. Upon shutdown, the delay or break timer starts and prevents restart until the delay on break and delay on make periods have expired.

During routine operation of the unit with no power interruptions, the compressor will operate on demand with no delay.

High Pressure Switch and Lockout Sequence

If the high pressure switch opens, the compressor contactor will de-energize immediately. The lockout timer will go into a *soft lockout* and stay in soft lockout until the high pressure switch closes and the delay on break time has expired. If the high pressure switch opens again in this same operating cycle, the unit will go into *manual lockout* condition and the alarm relay circuit will energize. Recycling the wall thermostat resets the manual lockout.

Low Pressure Switch, Bypass, and Lockout Sequence

If the low pressure switch opens for more than 120 seconds, the compressor contactor will de-energize and go into a soft lockout. Regardless the state of the low

pressure switch, the contactor will reenergize after the delay on make time delay has expired. If the low pressure switch remains open, or opens again for longer than 120 seconds, the unit will go into manual lockout condition and the alarm relay circuit will energize. Recycling the wall thermostat resets the manual lockout.

Alarm Relay Output

Alarm terminal is output connection for applications where alarm relay is employed. This terminal is powered whenever compressor is locked out due to HPC or LPC sequences as described.

NOTE: Both high and low pressure switch controls are inherently automatic reset devices. The high pressure switch and low pressure switch cut out and cut in settings are fixed by specific air conditioner or heat pump unit model. The lockout features, both soft and manual, are a function of the Compressor Control Module.

ADJUSTMENTS

Adjustable Delay on Make and Delay on Break Timer

The potentiometer is used to select Delay on Break time from 30 seconds to 5 minutes. Delay on Make (DOM) timing on power-up and after power interruptions is equal to 2 minutes plus 10% of Delay on Break (DOB) setting:

0.5 minute (30 seconds)	DOB = 123 second	DOM
1.0 minute (60 seconds)	DOB = 126 second	DOM
2.0 minute (120 seconds)	DOB = 132 second	DOM
3.0 minute (180 seconds)	DOB = 138 second	DOM
4.0 minute (240 seconds)	DOB = 144 second	DOM
5.0 minute (300 seconds)	DOB = 150 second	DOM

During routine operation of the unit with no power interruptions the compressor will operate on demand with no delay.

Typical Settings for Dual Unit Installation:

Unit 1: DOB set at 2 minutes, and DOM is 132 seconds

Unit 2: DOB set at 4 minutes, and DOM is 144 seconds

PRESSURE SERVICE PORTS

High and low pressure service ports are installed on all units so that the system operating pressures can be observed. A pressure table can be found later in the manual covering all models. It is imperative to match the correct pressure table to the unit by model number.

TROUBLESHOOTING

FAN BLADE SETTING DIMENSIONS

Shown in Figure 9 is the correct fan blade setting dimension for proper air delivery across the outdoor coil.

Any service work requiring removal or adjustment in the fan and/or motor area will require that the dimensions below be checked and blade adjusted in or out on the motor shaft accordingly.

**FIGURE 9
FAN BLADE SETTING**

**TABLE 5
FAN BLADE DIMENSION**

Model	Dimension A
WA381 WA423 WA484 WA491 WA605	1.75"

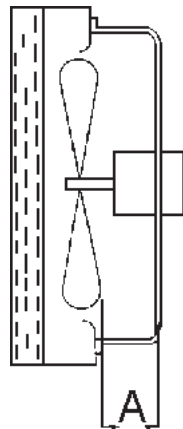

MIS-1724

REMOVAL OF FAN SHROUD

1. Disconnect all power to the unit.
2. Remove the screws holding both grilles, one on each side of unit, and remove grilles.
3. Remove screws holding fan shroud to condenser and bottom. Nine (9) screws.

4. Unwire condenser fan motor.
5. Slide complete motor, fan blade, and shroud assembly out the left side of the unit.
6. Service motor/fan as needed.
7. Reverse steps to reinstall.

REFRIGERANT CHARGE

The correct system R-22 charge is shown on the unit rating plate. Optimum unit performance will occur with a refrigerant charge resulting in a suction line temperature (6" from compressor) as shown in Table 6.

**TABLE 6
REFRIGERANT CHARGE**

Model	Rated Airflow	95 OD Temperature	82 OD Temperature
WA381	1100	50 - 48	48 - 46
WA423	1400	52 - 54	64 - 66
WA484	1550	54 - 56	65 - 67
WA491	1250	48 - 46	47 - 45
WA605	1700	53 - 55	60 - 62

The suction line temperatures in table above are based upon 80°F dry bulb / 67°F wet bulb (50% R.H.) temperature and rated airflow across the evaporator during cooling cycle.

**TABLE 7
INDOOR BLOWER PERFORMANCE
CFM @ 230V**

E.S.P. In H ₂ O	WA423, WA484				WA605			
	Low 230V		High 230V		Low 230V		High 230V	
	Dry Coil	Wet Coil	Dry Coil	Wet Coil	Dry Coil	Wet Coil	Dry Coil	Wet Coil
.0	1650	1600	1885	1800	1600	1450	2200	2000
.1	1550	1500	1770	1665	1525	1375	2100	1900
.2	1450	1400	1635	1540	---	---	2000	1800
.3	1350	1300	1500	1400	---	---	1875	1700
.4	1300	1175	1370	1285	---	---	1775	1600
.5	---	---	1250	1150	---	---	1650	1475

Table 7A on Page 19 for models WA381 and WA491

**TABLE 7A
INDOOR BLOWER PERFORMANCE
CFM @ 230V / 460V**

E.S.P. In H ₂ O	WA381						WA491			
	High Speed		Medium Speed		Low Speed		High Speed		Medium Speed	
	Dry Coil	Wet Coil	Dry Coil	Wet Coil	Dry Coil	Wet Coil	Dry Coil	Wet Coil	Dry Coil	Wet Coil
.0	1625	1475	1425	1325	1125	1100	1700	1550	1475	1375
.1	1475	1350	1325	1200	1100	1000	1550	1400	1375	1250
.2	1350	1150	1200	125	1000	850	1400	1250	1250	1100
.3	1150	825	---	875	---	---	1250	1100	1100	---

**TABLE 8
RECOMMENDED AIRFLOW**

Model	Rated CFM *	Rated ESP *	Recommended Airflow Range	Factory Speed Connection
WA381	1100	.15	1250 - 850	Medium
WA423	1400	.30	1600 - 1150	High
WA484	1550	.20	1750 - 1285	High
WA491	1250	.20	1475 - 1100	High
WA605	1700	.30	1950 - 1375	High

**TABLE 9
MAXIMUM ESP OF OPERATION
ELECTRIC HEAT ONLY**

Model KW	WA423		WA484		WA605	
	High Speed	Low Speed	High Speed	Low Speed	High Speed	Low Speed
-A05	.50	.50	.50	.50	.50	.50
-A10	.50	.50	.50	.50	.50	.50
-A15	.50	.50	.50	.50	.50	.50
-A20	.50	.45	.50	.45	.50	.40
-B09	.50	.50	.50	.50	.50	.50
-B15	.50	.50	.50	.50	.50	.50
-B18	.50	.50	.50	.50	.50	.50
-C09	.50	.50	.50	.50	.50	.50
-C15	.50	.50	.50	.50	.50	.50

Values shown are for units equipped with standard 1-inch throwaway filter or 1-inch washable filter. Derate ESP by .15 for 2-inch pleated filters.

**TABLE 9A
MAXIMUM ESP OF OPERATION
ELECTRIC HEAT ONLY**

Model KW	WA381			WA491	
	High Speed	Med Speed	Low Speed	High Speed	Med Speed
-A05	.30	.30	.30	.30	.30
-A08	.30	.30	.30	.40	.40
-A10	.30	.30	.20	.30	.30
-B06	.40	.30	.30	.30	.30
-B09	.40	.30	.30	.30	.30
-C06	.30	.30	.30	.30	.30
-C09	.30	.30	.30	.30	.30

Values shown are for units equipped with standard 1 inch throwaway filter or 1 inch washable filter. Derate ESP by .15 for 2 inch pleated filters.

**TABLE 10
PRESSURE TABLE**

COOLING

Air Temperature Entering Outdoor Coil °F

Model	Return Air Temperature	Pressure	75	80	85	90	95	100	105	110	115
WA381	75 deg. DB 62 deg. WB	Low Side High Side	74 175	74 187	75 202	76 216	78 232	79 249	79 265	80 284	81 302
	80 deg. DB 67 deg. WB	Low Side High Side	79 179	79 192	80 207	81 222	83 238	84 255	85 272	86 291	87 310
	85 deg. DB 72 deg. WB	Low Side High Side	82 185	82 199	83 214	84 230	86 246	87 264	88 282	89 301	90 321
WA423	75 deg. DB 62 deg. WB	Low Side High Side	70 207	72 220	73 235	75 251	76 266	77 283	78 300	79 318	79 337
	80 deg. DB 67 deg. WB	Low Side High Side	75 212	77 226	78 241	80 257	81 273	82 290	83 308	84 326	85 346
	85 deg. DB 72 deg. WB	Low Side High Side	78 219	80 234	81 249	83 266	84 283	85 300	86 319	87 337	88 358
WA484	75 deg. DB 62 deg. WB	Low Side High Side	73 204	74 217	76 232	78 248	79 265	80 284	82 304	83 325	84 348
	80 deg. DB 67 deg. WB	Low Side High Side	78 210	79 223	81 238	82 254	84 272	86 291	87 312	89 334	90 357
	85 deg. DB 72 deg. WB	Low Side High Side	84 217	85 231	87 247	88 264	90 282	92 302	93 323	95 345	97 369
WA491	75 deg. DB 62 deg. WB	Low Side High Side	70 199	71 213	71 227	72 244	73 260	75 279	76 298	77 320	79 341
	80 deg. DB 67 deg. WB	Low Side High Side	75 204	76 218	76 233	77 250	78 267	80 286	81 306	82 328	84 350
	85 deg. DB 72 deg. WB	Low Side High Side	78 211	79 226	79 241	80 259	81 276	83 296	84 317	85 339	87 362
WA605	75 deg. DB 62 deg. WB	Low Side High Side	71 215	72 228	73 242	74 256	75 273	76 290	77 307	79 326	79 345
	80 deg. DB 67 deg. WB	Low Side High Side	76 221	77 234	78 248	79 263	80 280	81 297	82 315	84 334	85 354
	85 deg. DB 72 deg. WB	Low Side High Side	79 229	80 242	81 257	82 272	83 290	84 307	85 326	87 346	88 366

Low side pressure ± 2 PSIG
High side pressure ± 5 PSIG

Tables are based upon rated CFM (airflow) across the evaporator coil. If there is any doubt as to correct operating charge being in the system, the charge should be removed, system evacuated and recharged to serial plate instructions.

NOTE: Pressure table based on high speed condenser fan operation. If condensing pressures appear elevated check condenser fan wiring. See "Condenser Fan Operation" on Page 16.

**TABLE 11
OPTIONAL ACCESSORIES**

Part Number	Description	WA381-A	WA381-B	WA381-C	WA423-A	WA423-B	WA423-C	WA484-A	WA484-B	WA484-C	WA491-A	WA491-B	WA491-C	WA605-A	WA605-B	WA605-C
EHWA05-A05	Heater Packages				X			X						X		
EHWA05-A08	Heater Packages				X			X						X		
EHWA05-A10	Heater Packages				X			X						X		
EHWA05-A15	Heater Packages				X			X						X		
EHWA38-A05	Heater Packages	X								X						
EHWA38-A08	Heater Packages	X								X						
EHWA38-A10	Heater Packages	X														
EHWA49-A05	Heater Packages										X					
EHWA05-B09	Heater Packages					X			X						X	
EHWA05-B15	Heater Packages					X			X						X	
EHWA05-B18	Heater Packages					X			X						X	
EHWA38-B06	Heater Packages		X													
EHWA38-B09	Heater Packages		X										X			
EHWA49-B06	Heater Packages											X				
EHWA05-C09A	Heater Packages			X			X			X			X			X
EHWA05-C15	Heater Packages						X			X						X
EHWA38-C06	Heater Packages		X													X
BOP-5	Blank Off Plate	X	X	X	X	X	X	X	X	X	X	X	X	X	X	X
BFAD-5	Barometric Fresh Air Damper	X	X	X	X	X	X	X	X	X	X	X	X	X	X	X
MFAD-5	Motorized Fresh Air Damper	X	X	X	X	X	X	X	X	X	X	X	X	X	X	X
CRV-5	Commercial Ventilator with Exhaust	X	X	X	X	X	X	X	X	X	X	X	X	X	X	X
EIFM-5	Economizer with Exhaust	X	X	X	X	X	X	X	X	X	X	X	X	X	X	X
WERV-A5B	Energy Recovery Ventilator	X	X	X	X	X	X	X	X	X	X	X	X	X	X	X
WERV-C5B	Energy Recovery Ventilator			X		X				X			X			X
CMA-6	Low Ambient Control (LAC)	X	X	X	X	X	X	X	X		X	X	X	X	X	X
CMA-10	LPC + HPC + TDR				X	X	X									
CMA-13	LPC + HPC + TDR + LAC				X	X										
CMC-15	Start Kit	X			X			X			X			X		
CMA-16	Low Pressue Control	X	X	X				X	X	X	X	X	X	X	X	X
CMA-18	LPC + LAC	X	X	X				X	X	X	X	X	X	X	X	
WMCB-05B	Circuit Breaker Kit					X			X							
WMCD-01C	Pull Disconnect Kit			X			X			X			X			X
WMCB-08A	Circuit Breaker				X			X			X					
WMCB-09A	Circuit Breaker													X		
WMCB-07B	Circuit Breaker														X	
WMCB-05A	Circuit Breaker	X														
WMCB-04B	Circuit Breaker		X													
WMCB-06B	Circuit Breaker											X				