INSTALLATION INSTRUCTIONS

LOW VOLTAGE CONTROL CIRCUIT WIRING

Models:

W**A2 W**A2D W**L2

NOTE: For 10 EER models W**AA and W**LA, see low voltage control wiring schematics in unit installation instructions.



Bard Manufacturing Company, Inc.
Bryan, Ohio 43506
www.bardhvac.com

Manual No.: 2100-582E
Supersedes: 2100-582D
Date: 7-26-17

CONTENTS

Installation

Wiring – Low Voltage Wiring.....	3
Operating Voltage Range	3
Low Voltage Connections.....	3

Tables

Table 1	Diagram to Use w/Unit and Vents.....	3
Table 2	Operating Voltage Range.....	3
Table 3	Wall Thermostat.....	4
Table 4	Humidity Controls	4
Table 5	CO ₂ Controller.....	4
Table 6	Thermostat Wire Size.....	4

Figures

Figure 1	Basic A/C with Optional Electric Heat No Economizer or Vent Packages	5
Figure 2	Opt. MFAD, CRV or ERV Vent. Pkg. w/Programmable T-Stat.....	6
Figure 3	Opt. MFAD, CRV or ERV Vent. Pkg. w/Non-Programmable T-Stat.....	7
Figure 4	A/C with Economizer	8
Figure 5	A/C w/Dehumidification Sequence & No Vent Pkg.	9
Figure 6	A/C w/Dehumidification Sequence & No Vent Pkg. Using Sep. Controls	10
Figure 7	A/C w/Dehumidification Sequence w/Vent Pkg. Using Combination Controller.....	11
Figure 8	A/C w/Dehumidification Sequence w/Vent Pkg. Using Non-Prog. T-Stat & Separate Humidity Controller	12
Figure 9	A/C w/Dehumidification Sequence & Economizer	13
Figure 10	A/C w/Dehumidification Sequence & Economizer w/Combination Temperature & Humidity Control	14
Figure 11	A/C w/CS2000 Wiring Diagram	15
Figure 12	1-Stage A/C w/Opt. Elec. Heat w/ ECONWM* Style Economizer	16
Figure 13	A/C w/Dehumidification Sequence & ECONWM* Style Economizer with 8403-060 Combination Temperature & Humidity Control	17

TABLE 1 – Diagram to Use with Unit and Vents

System Type	Model	Vent		None		CRV, ERV, MFAD	CRVMP	EIFM		ECONWM*	CS2000A*
		Vent Code		X		R,M,V,P	C	E		T,W	
		Thermostat		Programmable		Programmable	ALL	Programmable		ALL	ALL
		No	Yes	No	Yes	All	No	Yes	All	All	
Air Conditioner	W**A, W**L	1	1	3	2	N/A	4	4	12	11	
Air Conditioner w/Dehumidification Sequence	W**A*D W**L*D	6	5	8	7	N/A	9	10	13	11	

WIRING – LOW VOLTAGE WIRING

All 230/208V, 1 phase and 3 phase units are equipped with dual primary voltage transformers. All equipment leaves the factory wired on 240V tap. For 208V operation, reconnect from 240V to 208V tap. The acceptable operating voltage range for the 240V and 208V taps are:

An 18 gauge copper, color-coded thermostat cable is recommended. The connection points are shown in this Manual. See table below.

TABLE 2 – Operating Voltage Range

TAP	RANGE
240V	253 – 216
208V	220 – 187

NOTE: The voltage should be measured at the field power connection point in the unit and while the unit is operating at full load (maximum amperage operating condition).

Low Voltage Connections

These units use a 24-volt AC low voltage circuit. The “RT” terminal is the 24V transformer output, and the “R” terminal is the 24VAC hot terminal for the operation of the equipment. “RT” and “R” are connected with brass jumper bar which can be removed and “RT” and “R” connected to external NC (normally closed) contact such as a fire/smoke detector that will cause immediate shutdown of the equipment upon activation.

“C” terminal is grounded.

“G” terminal is the fan input.

“Y” terminal is the compressor input for cooling units without economizer

“Y1” terminal is the 1st Stage input for cooling (if equipped with economizer)

“Y2” terminal is the 2nd Stage input for cooling (if equipped with economizer)

“W1” terminal is the 1st stage electric heat.

“W2” terminal is the 2nd stage heat (if equipped).

“A” terminal is the ventilation input. This terminal energizes any factory installed ventilation option.

“D” terminal is the dehumidification input. If installed, this terminal energizes any factory installed dehumidification option.

Low Voltage Connections for DDC Control	
1-Stage Units	
Fan Only	Energize G
1st Stage Cooling Mode	Energize Y, G
1st Stage Heating	Energize W1
2nd Stage Heating (if employed)	Energize W1, W2
Ventilation	Energize G, A
Dehumidification (if employed)	Energize D

TABLE 3
Wall Thermostat

Part Number	Predominate Features
8403-057 (TH3110D1040)	1 stage Cool, 1 stage Heat Electronic Non-Programmable Auto or Manual changeover
8403-058 (TH5220D1151)	2 stage Cool, 2 stage Heat Electronic Non-Programmable HP or Conventional (Default: HP) Auto or Manual changeover
8403-059 (TH5220D1219/U)	2 stage Cool, 2 stage Heat Electronic Non-Programmable HP or Conventional (Default: AC) Auto or Manual changeover
8403-060 (1120-445)	3 stage Cool; 3 stage Heat Programmable/Non-Programmable Electronic HP or Conventional Auto or Manual changeover Dehumidification Output

TABLE 4
Humidity Controls

Part Number	Predominate Features
8403-038 (H600A1014)	SPDT switching, pilot duty 50VA @ 24V Humidity range 20-80% RH
8403-047 (H200-10-21-10)	Electronic dehumidstat SPST closes-on-rise Humidity range 10-90% with adjustable stops

TABLE 5
CO₂ Controller





Part Number	Predominate Features
8403-067	Normally Open SPST relay closes-on-rise 24V dual wave length sensor. Default setting 950ppm, adjustable to 0-2000ppm Default off setting 1000ppm, adjustable to 0-200 ppm can be calibrated

TABLE 6
Thermostat Wire Size

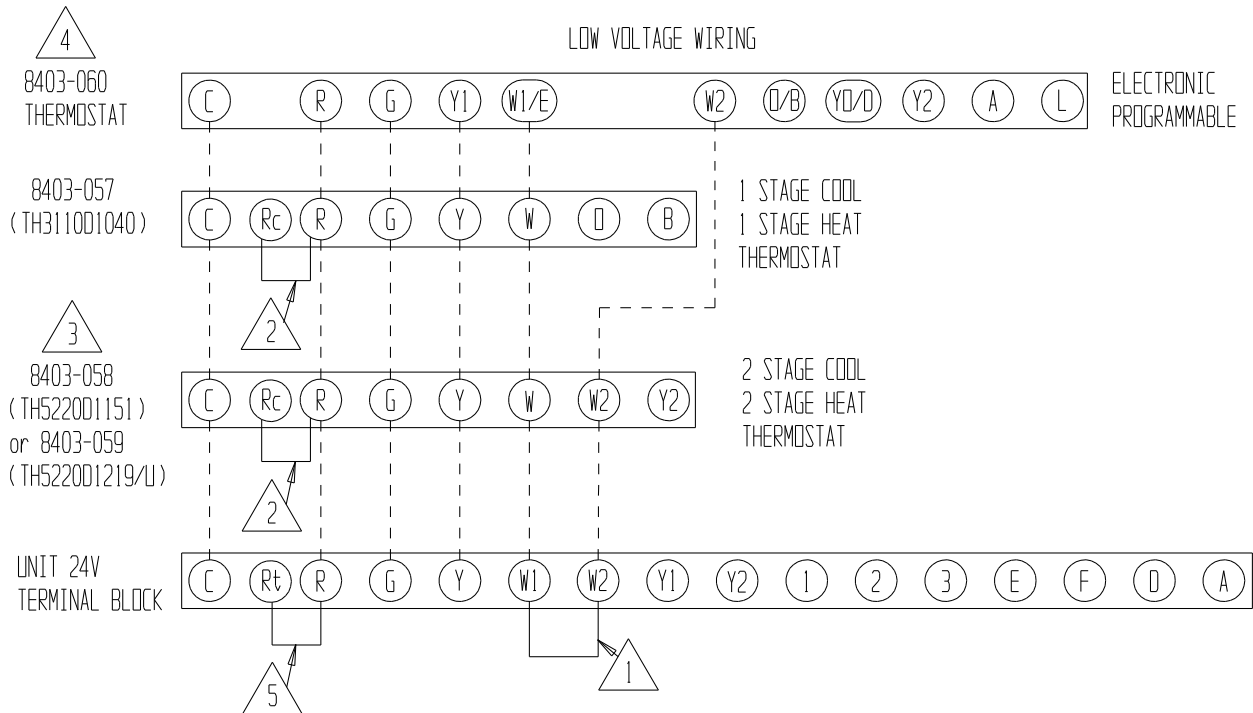
Transformer VA	FLA	Wire Gauge	Maximum Distance In Feet
55	2.3	20 gauge	45
		18 gauge	60
		16 gauge	100
		14 gauge	160
		12 gauge	250

FIGURE 1
Basic A/C with Optional Electric Heat
No Economizer or Ventilation Packages



-  REMOVE JUMPER FOR 2 STAGE ELECTRIC HEAT ON UNITS WITH 15 OR MORE KW
-  FACTORY INSTALLED JUMPER
-  FOR 8403-058, CHANGE "SYSTEM TYPE", SET UP FUNCTION 1, FROM 5 (2 HEAT/ 1 COOL HEAT PUMP) TO 6 (2 HEAT/ 2 COOL CONVENTIONAL). FOR 8403-059, NO CHANGE REQUIRED
-  CHANGE MODEL CONFIGURATION FROM HEAT PUMP TO HEAT/COOL.
-  FACTORY INSTALLED JUMPER. FOR IMMEDIATE EMERGENCY SHUTDOWN OF ALL HVAC OPERATION, REMOVE JUMPER AND CONNECT NORMALLY CLOSED (NC) CONTACT TO R AND Rt TERMINALS.

MIS-3138 A

FIGURE 2
Optional MFAD, CRV or ERV Ventilation Packages
with Programmable Thermostat (Recommended)

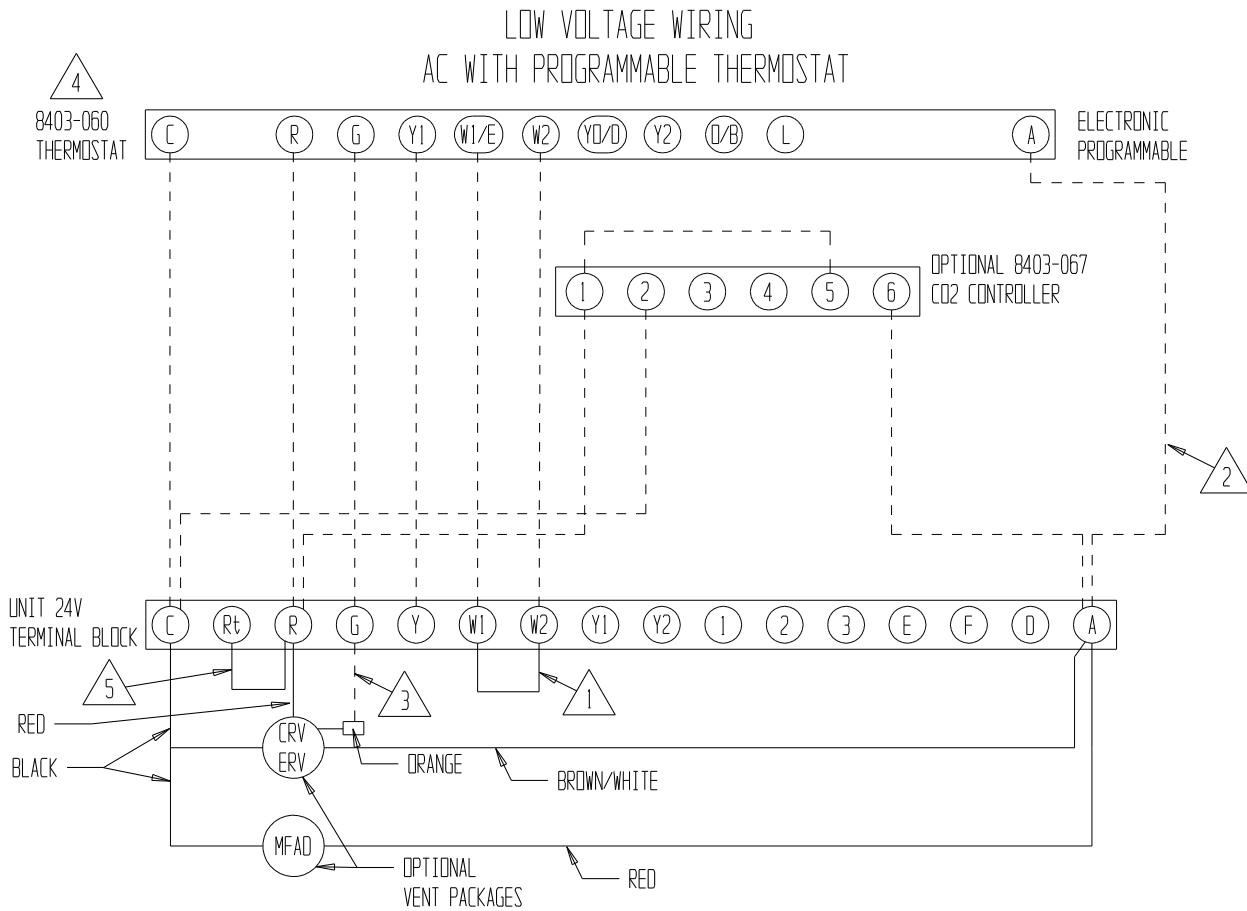

MIS-3139 A





-  REMOVE JUMPER FOR 2 STAGE ELECTRIC HEAT ON UNITS WITH 15 OR MORE KW
-  DO NOT CONNECT "A" FROM 8403-060 IF OPTIONAL CO₂ CONTROLLER IS USED
-  CONNECT ORANGE WIRE TO "G" ONLY IF OPTIONAL CO₂ CONTROLLER IS USED
-  CHANGE MODEL CONFIGURATION FROM HEAT PUMP TO HEAT/COOL. MUST BE CONFIGURED TO PROGRAMMABLE AND FAN SET TO PROGRAMMED FAN FOR THE "A" OUTPUT TO FUNCTION DURING SCHEDULED OCCUPIED PERIODS.
-  FACTORY INSTALLED JUMPER. FOR IMMEDIATE EMERGENCY SHUTDOWN OF ALL HVAC OPERATION, REMOVE JUMPER AND CONNECT NORMALLY CLOSED (NC) CONTACT TO R AND R_t TERMINALS.

FIGURE 3
Optional MFAD, CRV or ERV Ventilation Packages
with Non-Programmable Thermostat



- 1 REMOVE JUMPER FOR 2 STAGE ELECTRIC HEAT ON UNITS WITH 15 OR MORE KW
- 2 OPTIONAL VENT OPTION SUGGESTED HOOK UP
- 3 FACTORY INSTALLED JUMPER
- 4 ADD JUMPER IF OPTIONAL CO2 CONTROLLER IS NOT USED, VENT WILL RUN WHILE BLOWER IS ENERGIZED. DO NOT INSTALL JUMPER IF OPTIONAL CO2 CONTROLLER INSTALLED, AND SEE NOTE 6.
- 5 FOR 8403-058 CHANGE "SYSTEM TYPE", SET UP FUNCTION 1, FROM 5 (2 HEAT/ 1 COOL HEAT PUMP) TO 6 (2 HEAT/ 2 COOL CONVENTIONAL). FOR 8403-059, NO CHANGE
- 6 CONNECT ORANGE WIRE TO "G" ONLY IF OPTIONAL CO2 CONTROLLER IS INSTALLED.
- 7 FACTORY INSTALLED JUMPER. FOR IMMEDIATE EMERGENCY SHUTDOWN OF ALL HVAC OPERATION, REMOVE JUMPER AND CONNECT NORMALLY CLOSED (NC) CONTACT TO R AND Rt TERMINALS.

**FIGURE 4
A/C with EIFM**

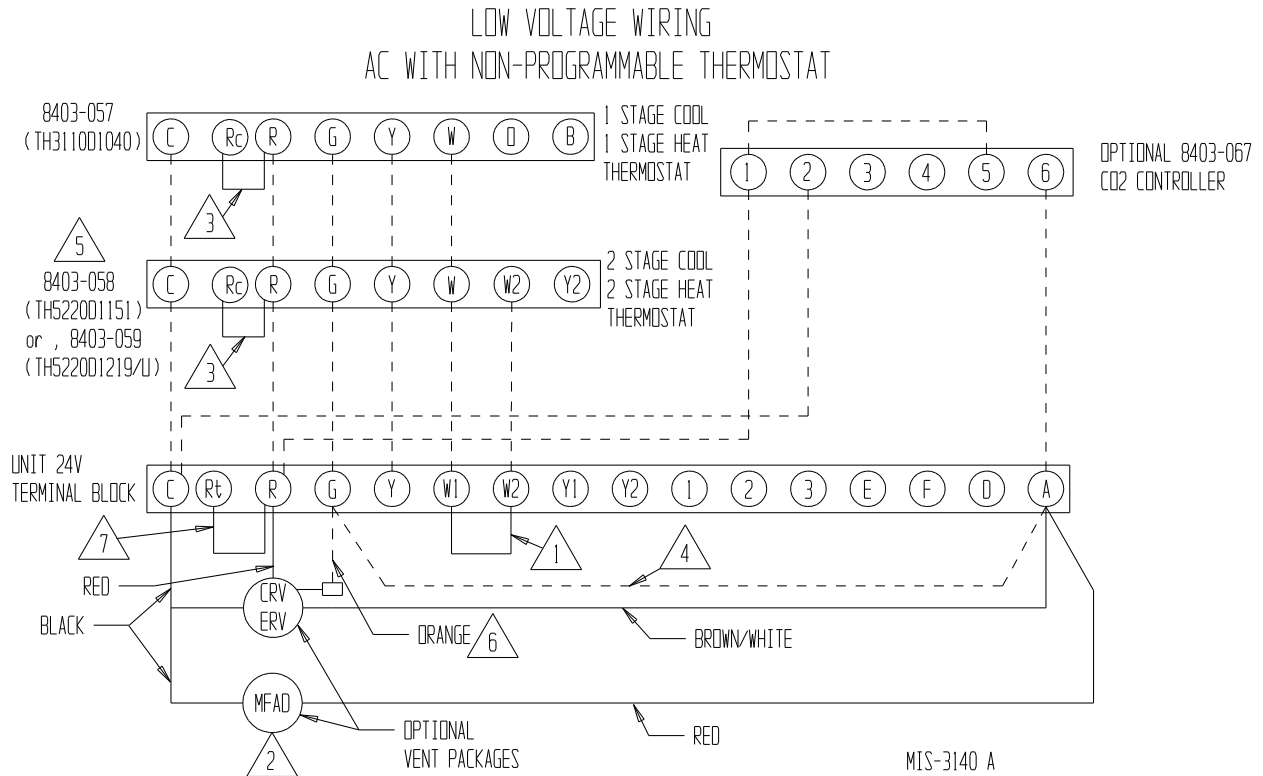
OPTIONAL ECONOMIZER LOW VOLTAGE WIRING

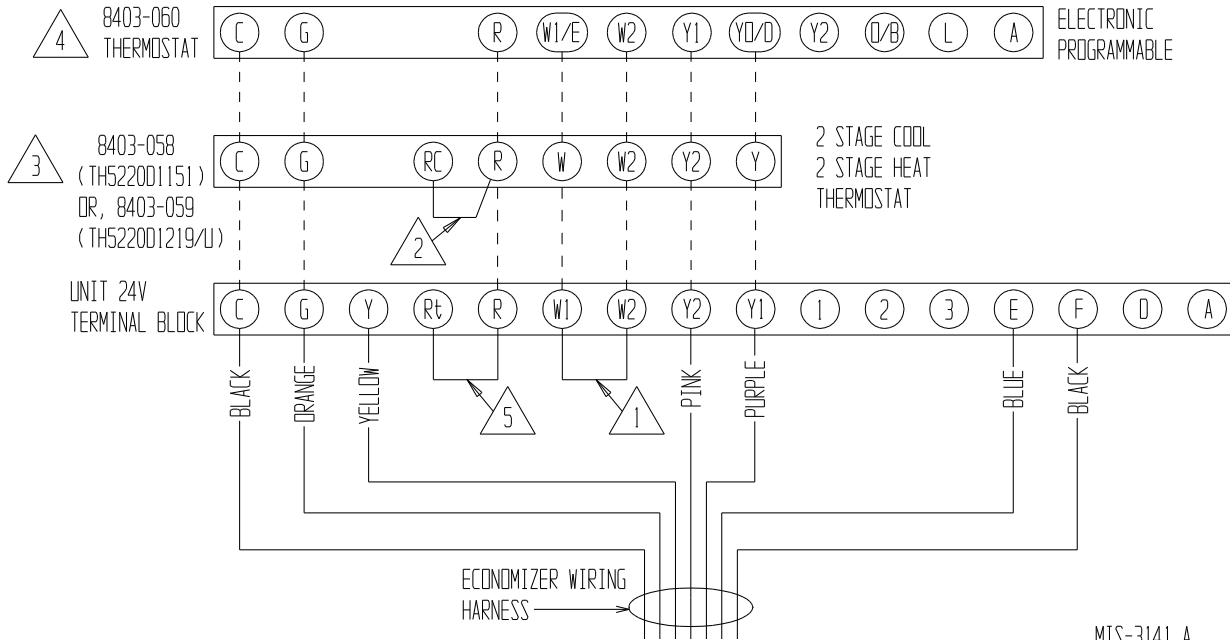

MIS-3141 A





-  REMOVE JUMPER FOR 2 STAGE ELECTRIC HEAT ON UNITS WITH 15 OR MORE KW
-  FACTORY INSTALLED JUMPER
-  FOR 8403-058, CHANGE "SYSTEM TYPE", SET UP FUNCTION 1, FROM 5 (2 HEAT/ 1 COOL HEAT PUMP) TO 6 (2 HEAT/ 2 COOL CONVENTIONAL). FOR 8403-059, NO CHANGE
-  CHANGE MODEL CONFIGURATION FROM HEAT PUMP TO HEAT/COOL, AND MUST BE CONFIGURED FOR ECONOMIZER FOR YD/D OUTPUT TO BE ACTIVE AS FIRST STAGE COOLING.
-  FACTORY INSTALLED JUMPER. FOR IMMEDIATE EMERGENCY SHUTDOWN OF ALL HVAC OPERATION, REMOVE JUMPER AND CONNECT NORMALLY CLOSED (NC) CONTACT TO R AND Rt TERMINALS.

FIGURE 5
A/C with Dehumidification Sequence
& No Ventilation Package Using
8403-060 Combination Temperature and Humidity Controller

LOW VOLTAGE WIRING

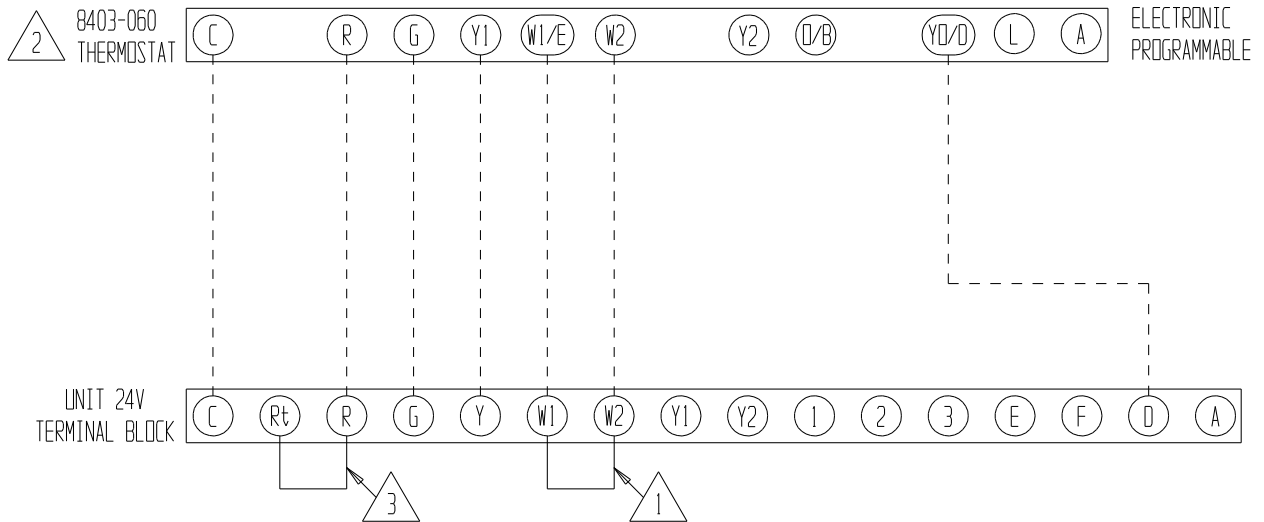

REMOVE JUMPER FOR 2 STAGE ELECTRIC HEAT ON UNITS WITH 15 OR MORE KW

MIS-3142



CHANGE MODEL CONFIGURATION FROM HEAT PUMP TO HEAT/COOL, AND MUST BE CONFIGURED FOR "NO ECONOMIZER" TO MAKE YO/D OUTPUT ACTIVE FOR HUMIDITY CONTROL



FACTORY INSTALLED JUMPER. FOR IMMEDIATE EMERGENCY SHUTDOWN OF ALL HVAC OPERATION, REMOVE JUMPER AND CONNECT NORMALLY CLOSED (NC) CONTACT TO R AND Rt TERMINALS.

FIGURE 6
A/C with Dehumidification Sequence
& No Ventilation Package Using Separate
Temperature and Humidity Controls

LOW VOLTAGE WIRING

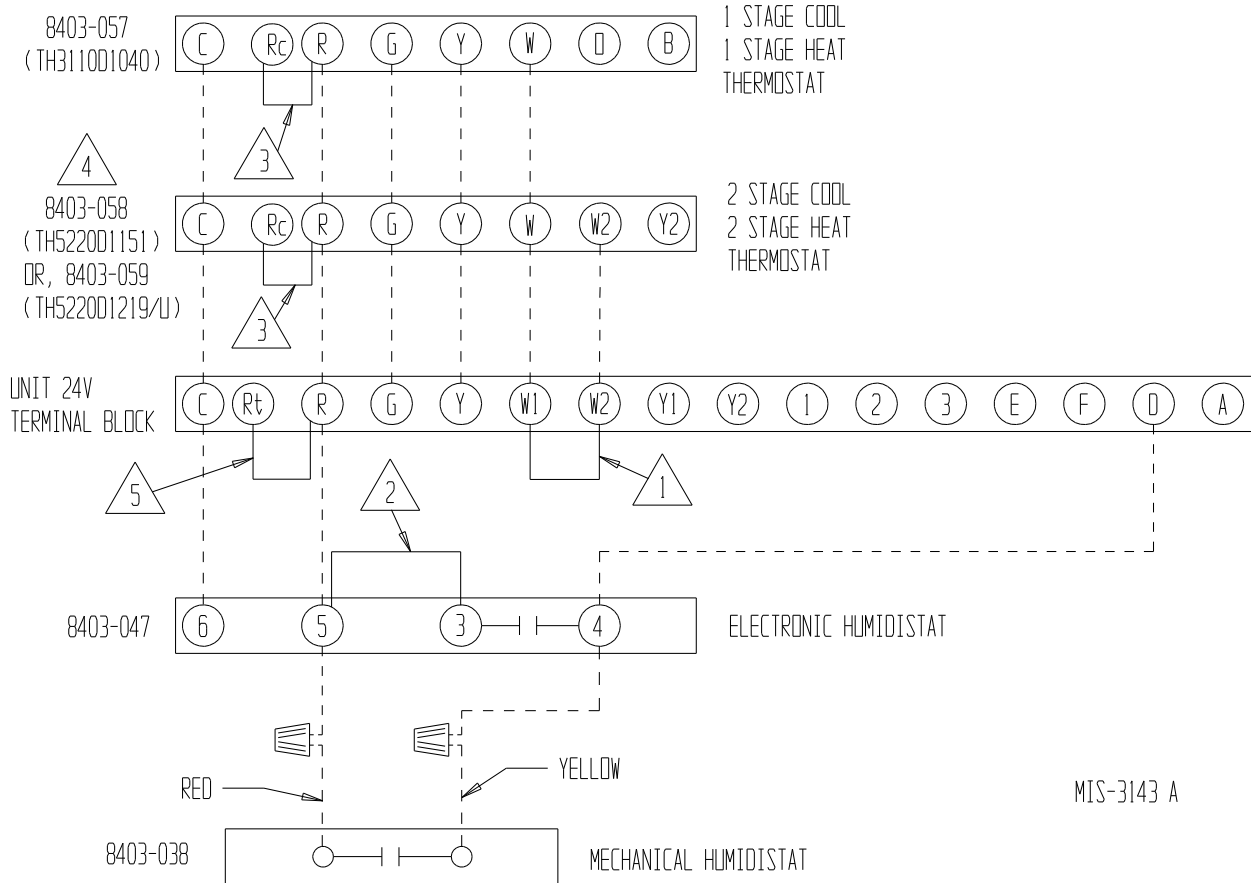

MIS-3143 A





-  REMOVE JUMPER FOR 2 STAGE ELECTRIC HEAT ON UNITS WITH 15 OR MORE KW
-  JUMPER NEEDS TO BE ADDED
-  FACTORY INSTALLED JUMPER
-  FOR 8403-058, CHANGE "SYSTEM TYPE", SET UP FUNCTION 1, FROM 5 (2 HEAT/ 1 COOL HEAT PUMP) TO 6 (2 HEAT/ 2 COOL CONVENTIONAL). FOR 8403-059, NO CHANGE
-  FACTORY INSTALLED JUMPER. FOR IMMEDIATE EMERGENCY SHUTDOWN OF ALL HVAC OPERATION, REMOVE JUMPER AND CONNECT NORMALLY CLOSED (NC) CONTACT TO R AND Rt TERMINALS.

FIGURE 7
A/C with Dehumidification Sequence
with Ventilation Package Using
8403-060 Combination Temperature & Humidity Controller
and 8403-067 CO₂ Controller



1 REMOVE JUMPER FOR 2 STAGE ELECTRIC HEAT ON UNITS WITH 15 OR MORE KW

MIS-3144

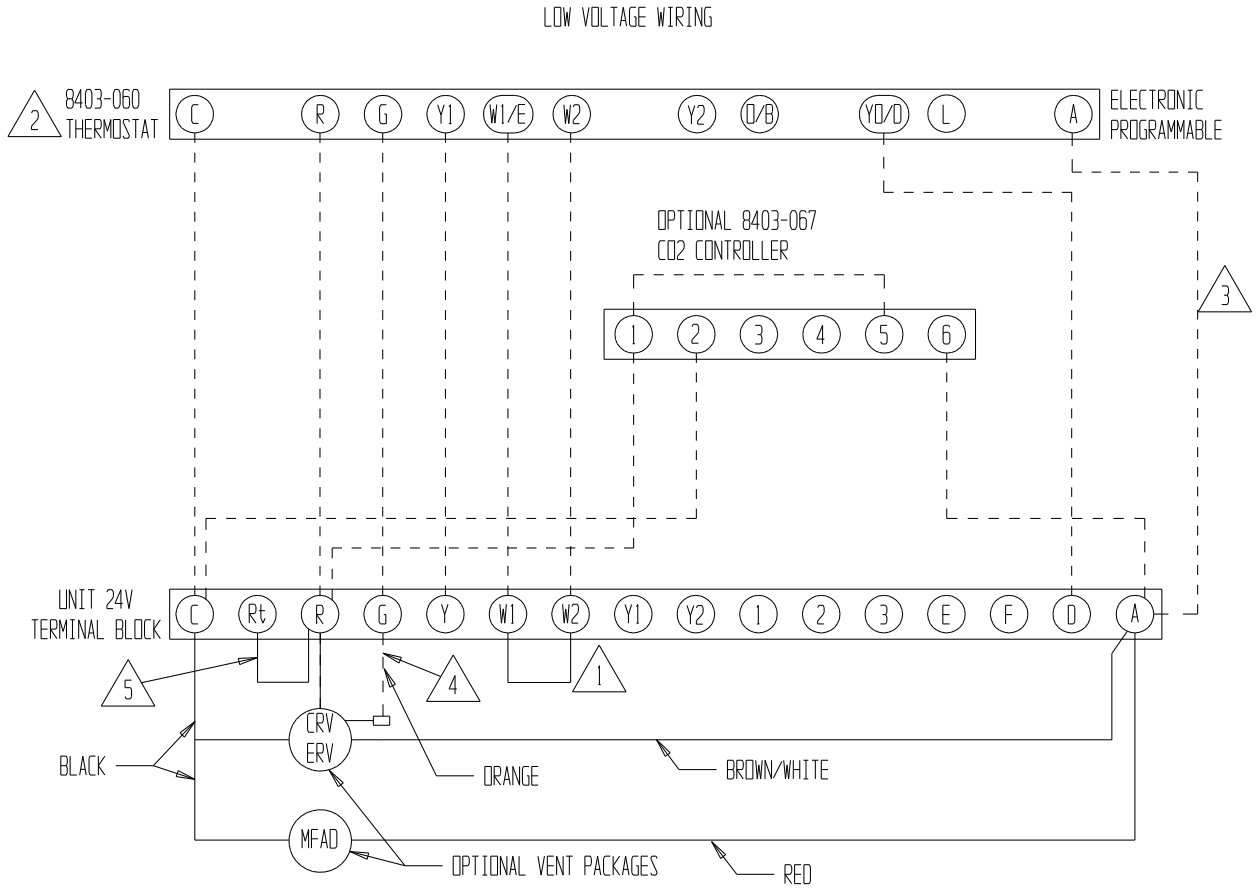
2 CHANGE MODEL CONFIGURATION FROM HEAT PUMP TO HEAT/COOL, AND MUST BE CONFIGURED FOR "NO ECONOMIZER" TO MAKE YD/D OUTPUT ACTIVE FOR HUMIDITY CONTROL

3 DO NOT CONNECT "A" FROM 8403-060 IF OPTIONAL CO₂ CONTROLLER IS USED

4 CONNECT ORANGE WIRE TO "G" ONLY IF OPTIONAL CO₂ CONTROLLER IS USED.

5 FACTORY INSTALLED JUMPER. FOR IMMEDIATE EMERGENCY SHUTDOWN OF ALL HVAC OPERATION, REMOVE JUMPER AND CONNECT NORMALLY CLOSED (NC) CONTACT TO R AND Rt TERMINALS.

FIGURE 8
A/C with Dehumidification Sequence
with Ventilation Package Using
Non-Programmable Thermostat
and Separate Humidity Controller

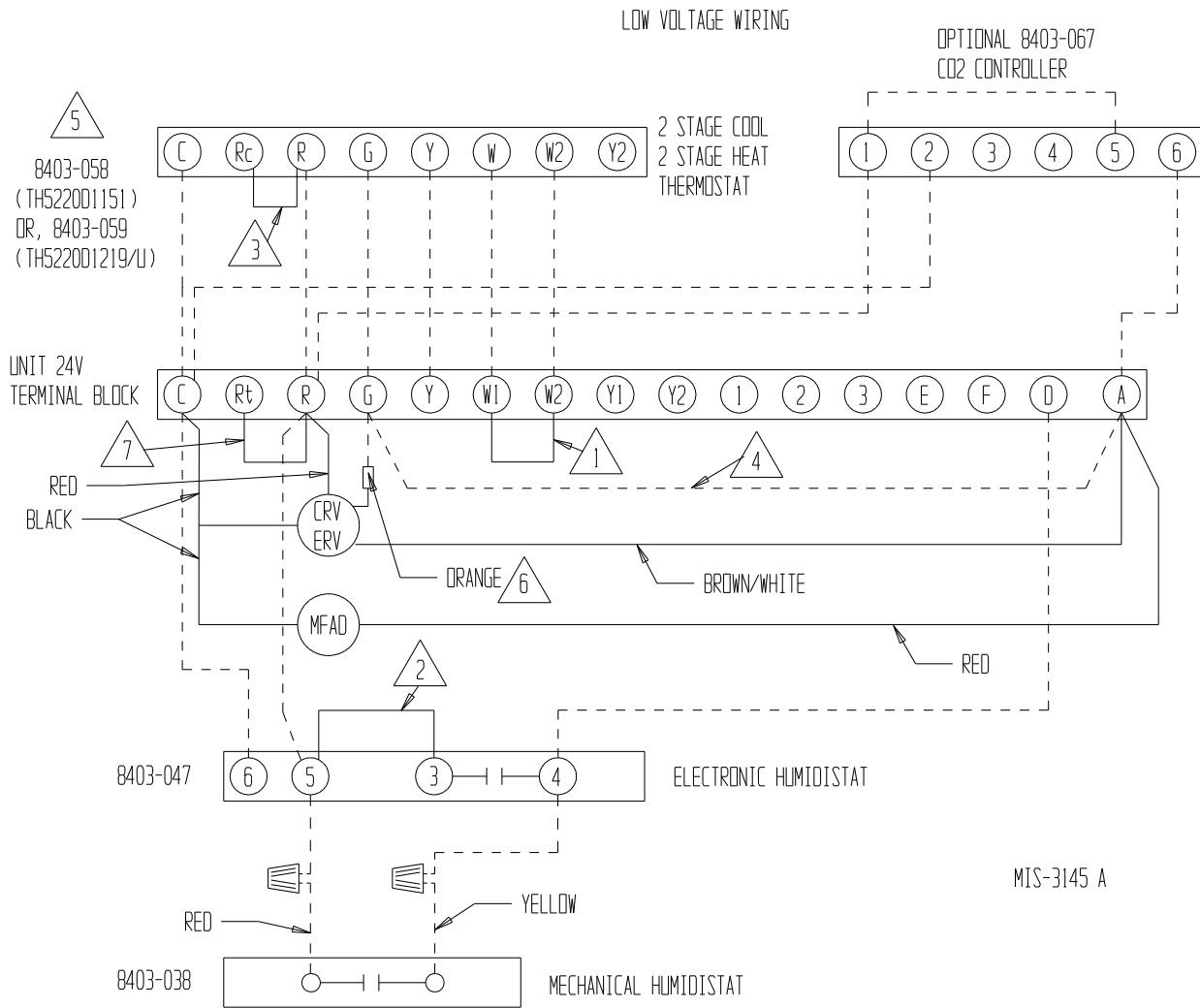

- 1 REMOVE JUMPER FOR 2 STAGE ELECTRIC HEAT ON UNITS WITH 15 OR MORE KW
- 2 JUMPER NEEDS TO BE ADDED
- 3 FACTORY INSTALLED JUMPER
- 4 ADD JUMPER IF OPTIONAL CO2 CONTROLLER IS NOT USED. VENT WILL RUN WHILE BLOWER IS ENERGIZED, IF CO2 CONTROLLER IS INSTALLED, DO NOT ADD JUMPER AND SEE NOTE 6.
- 5 FOR 8403-058, CHANGE "SYSTEM TYPE", SET UP FUNCTION 1, FROM 5 (2 HEAT/ 1 COOL HEAT PUMP) TO 6 (2 HEAT/ 2 COOL CONVENTIONAL). FOR 8403-059, NO CHANGE
- 6 CONNECT ORANGE WIRE TO "G" ONLY IF OPTIONAL CO2 CONTROLLER IS INSTALLED.
- 7 FACTORY INSTALLED JUMPER. FOR IMMEDIATE EMERGENCY SHUTDOWN OF ALL HVAC OPERATION, REMOVE JUMPER AND CONNECT NORMALLY CLOSED (NC) CONTACT TO R AND Rt TERMINALS.

FIGURE 9
A/C with Dehumidification Sequence
& EIFM with 8403-058 Thermostat
and 8403-038 or 8403-047 Humidistat

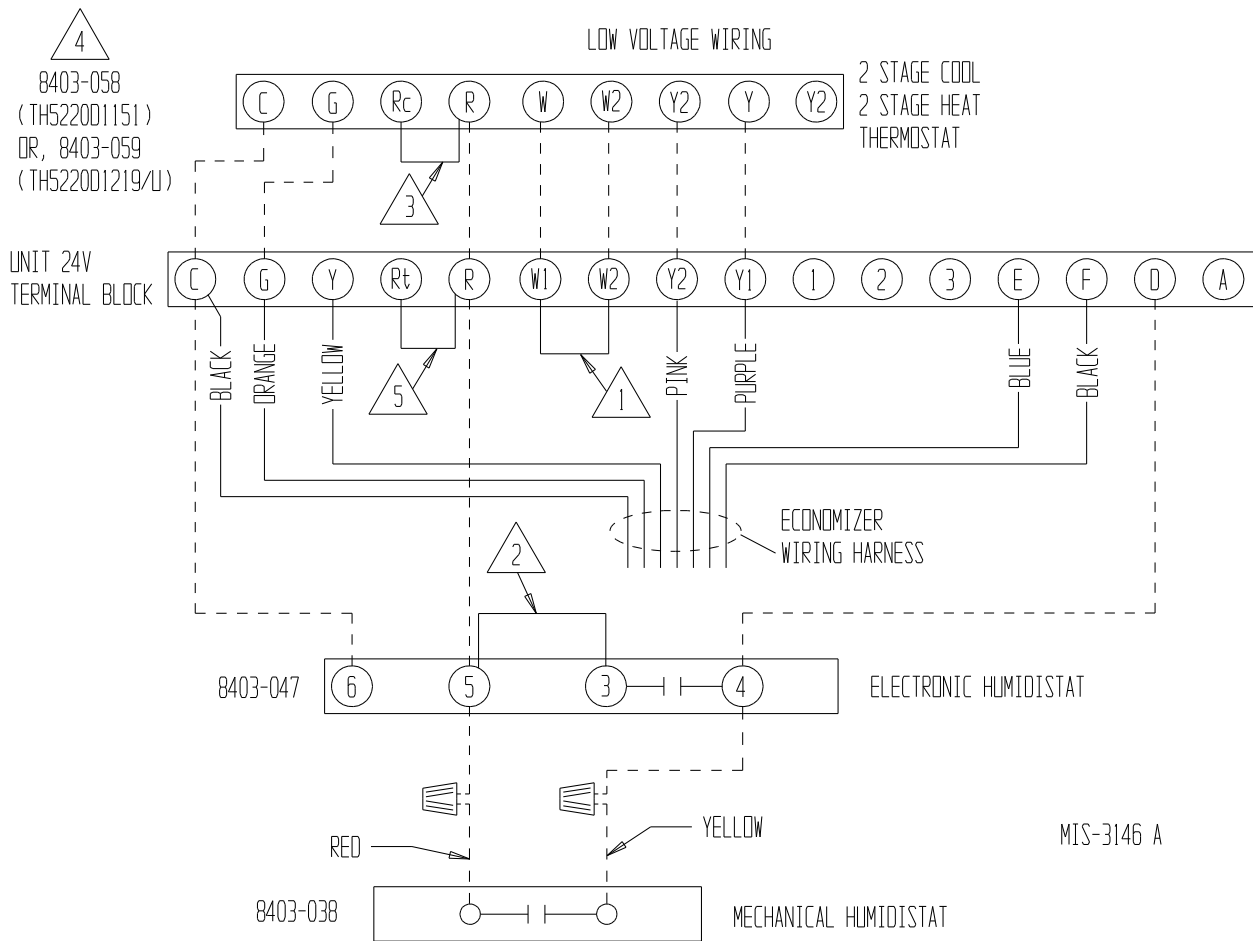

MIS-3146 A





- 
REMOVE JUMPER FOR 2 STAGE ELECTRIC HEAT ON UNITS WITH 15 OR MORE KW
- 
JUMPER NEEDS TO BE ADDED
- 
FACTORY INSTALLED JUMPER
- 
FOR 8403-058, CHANGE "SYSTEM TYPE", SET UP FUNCTION 1, FROM 5 (2 HEAT/ 1 COOL HEAT PUMP) TO 6 (2 HEAT/ 2 COOL CONVENTIONAL). FOR 8403-059, NO CHANGE
- 
FACTORY INSTALLED JUMPER. FOR IMMEDIATE EMERGENCY SHUTDOWN OF ALL HVAC OPERATION, REMOVE JUMPER AND CONNECT NORMALLY CLOSED (NC) CONTACT TO R AND Rt TERMINALS.

FIGURE 10
A/C with Dehumidification Sequence
& EIFM with 8403-060
Combination Temperature and Humidity Control

LOW VOLTAGE WIRING

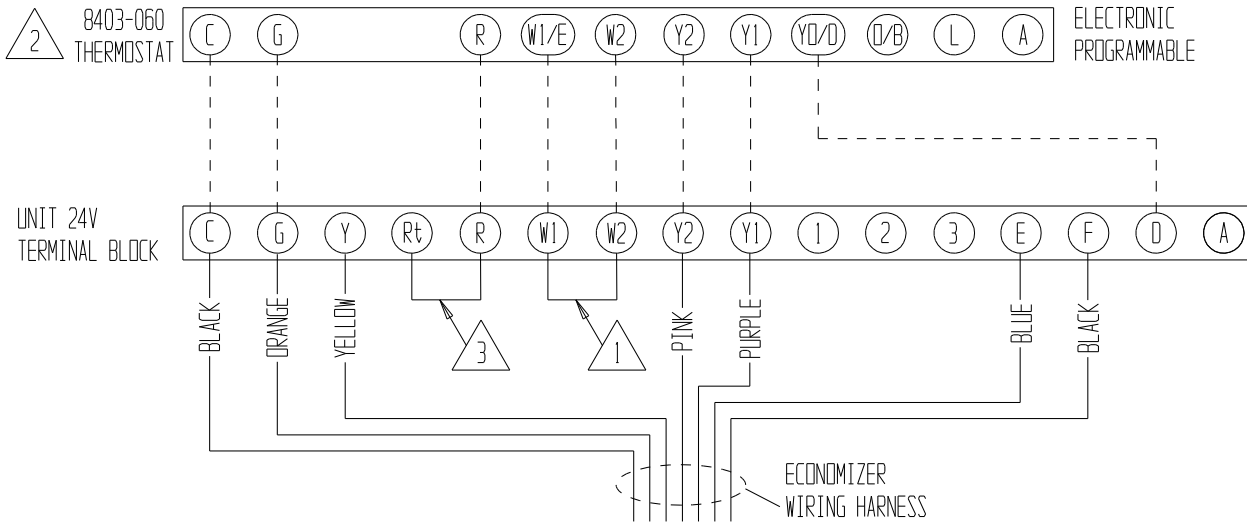

MIS-3147

- 1** REMOVE JUMPER FOR 2 STAGE ELECTRIC HEAT ON UNITS WITH 15 OR MORE KW
- 2** CHANGE MODEL CONFIGURATION FROM HEAT PUMP TO HEAT/COOL, AND MUST BE CONFIGURED FOR NO ECONOMIZER AND MULTI-STAGE FOR Y1 OUTPUT TO BE ACTIVE AS FIRST STAGE COOLING AND YD/D TO BE ACTIVE FOR HUMIDITY CONTROL
- 3** FACTORY INSTALLED JUMPER. FOR IMMEDIATE EMERGENCY SHUTDOWN OF ALL HVAC OPERATION, REMOVE JUMPER AND CONNECT NORMALLY CLOSED (NC) CONTACT TO R AND Rt TERMINALS.

FIGURE 11
A/C with CS2000

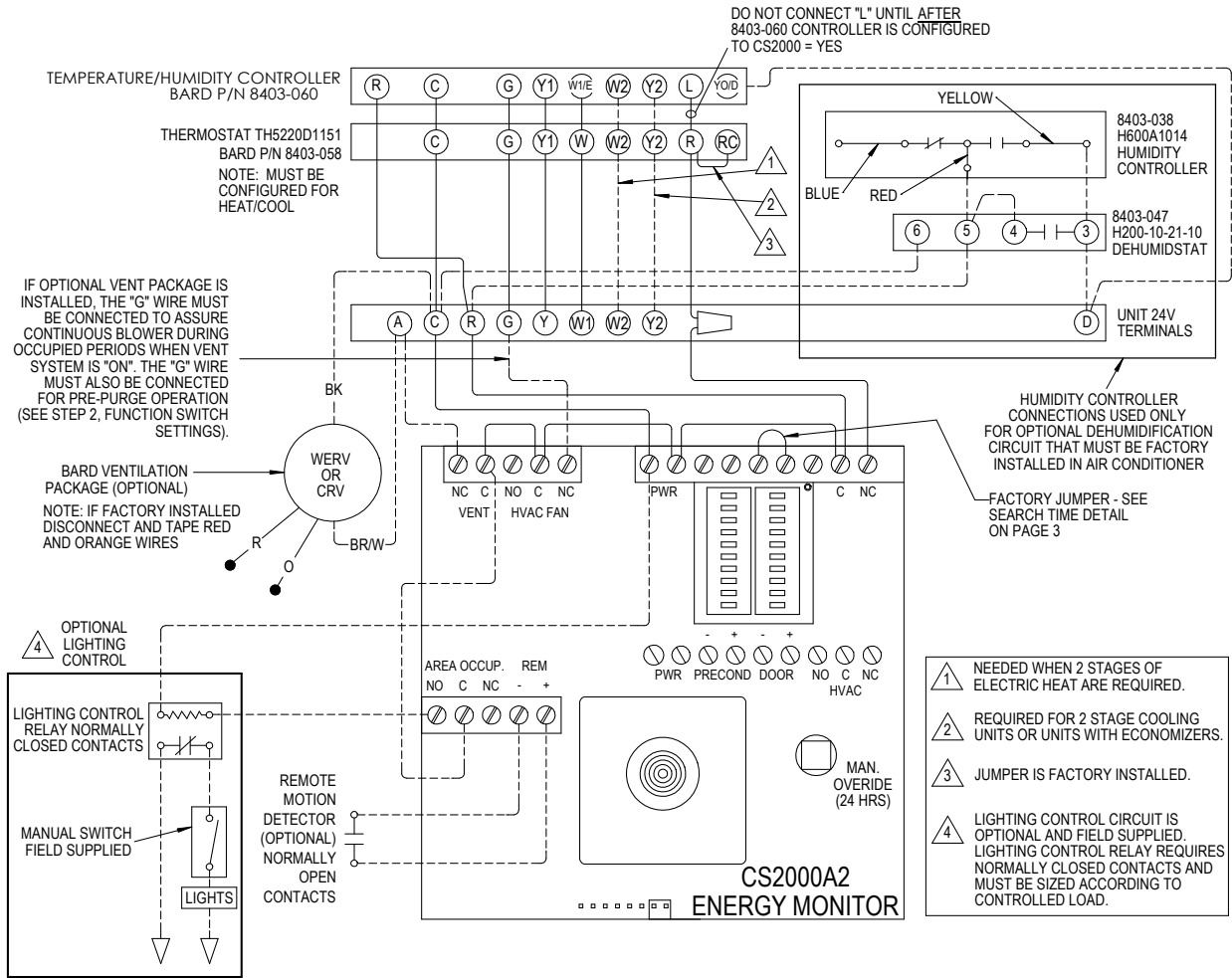

RECOMMENDED SWITCH SETTINGS SHOWN BELOW

FUNCTION SWITCHES		TEMPERATURE SWITCHES	
LEARN			90
PRE P			84
MODE			81
RATE			78
SEARCH-TIME			68
N/C			65
STAGE			62
AUX			58
DEMAND 2			54
DEMAND 1			48

4093-157

FIGURE 12
1-Stage A/C with Optional Electric Heat
with ECONWM* Style Economizer

Low Voltage Wiring Diagram

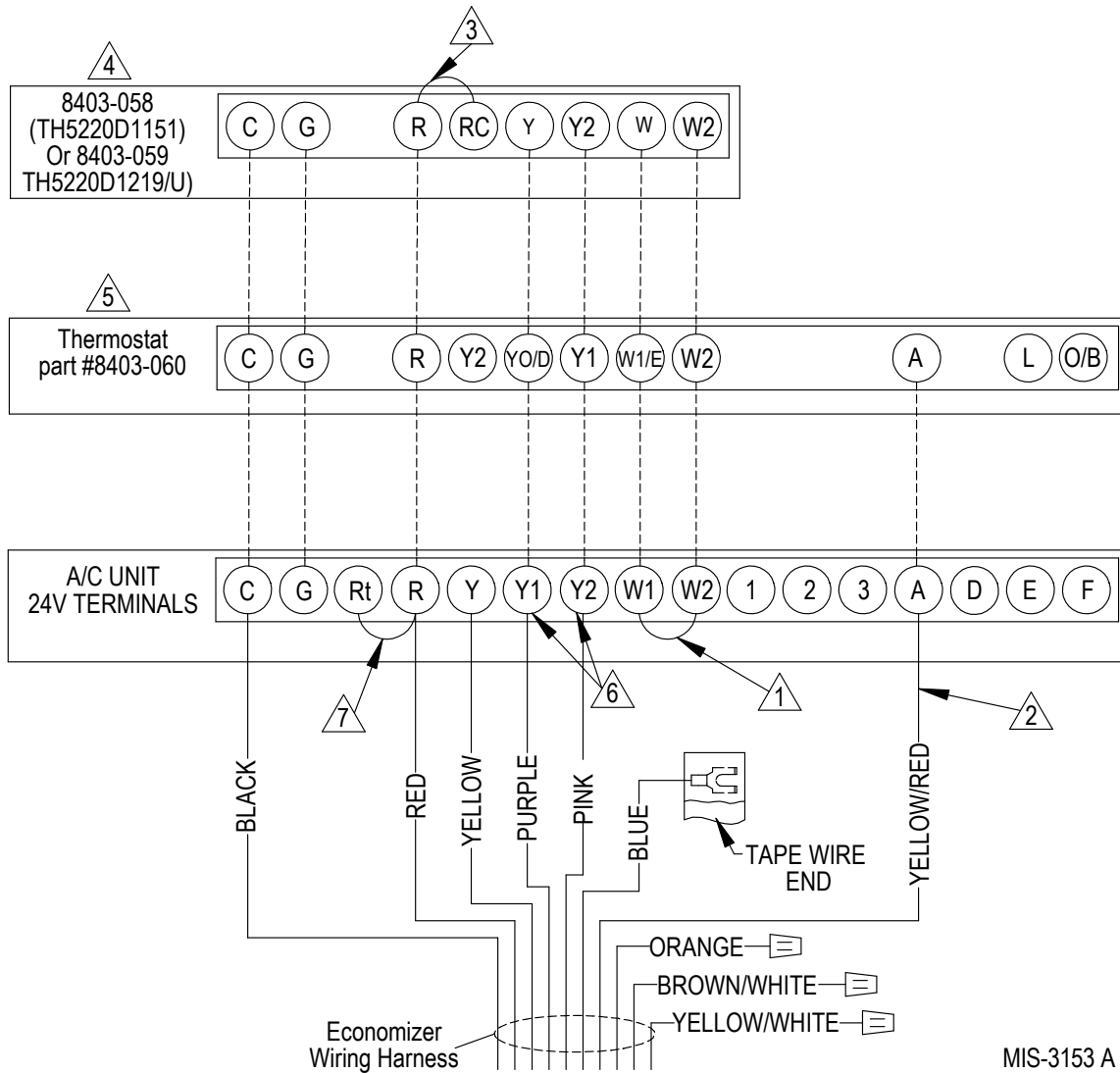

MIS-3153 A

- ① Factory installed jumper. Remove for 2-stage operation on units with 15 or more kw.
- ② Must be energized to enable minimum position. NOTE: Economizer Control Default Setting is 10V (100%). Depending upon application may require setting to lower value.
- ③ Factory Jumper Installed.
- ④ For 8403-058, Change "system type", set up function 1, from 5 (2 heat/ 1 cool heat pump) to 6 (2 heat/ 2 cool conventional). For 8403-059, No change.
- ⑤ Change model configuration from heat pump to heat/cool, and must be configured for economizer for YO/D output to be active as first stage cooling.
- ⑥ Older units may not have Y1 and Y2 connections on 24v terminal block. If not present wire nuts must be used.
- ⑦ Factory installed jumper. For immediate emergency shutdown of all HVAC operation, remove jumper and connect normally closed (NC) contact to R and Rt terminals.

FIGURE 13
A/C with Dehumidification Sequence
and ECONWM* Style Economizer with 8403-060
Combination Temperature and Humidity Control

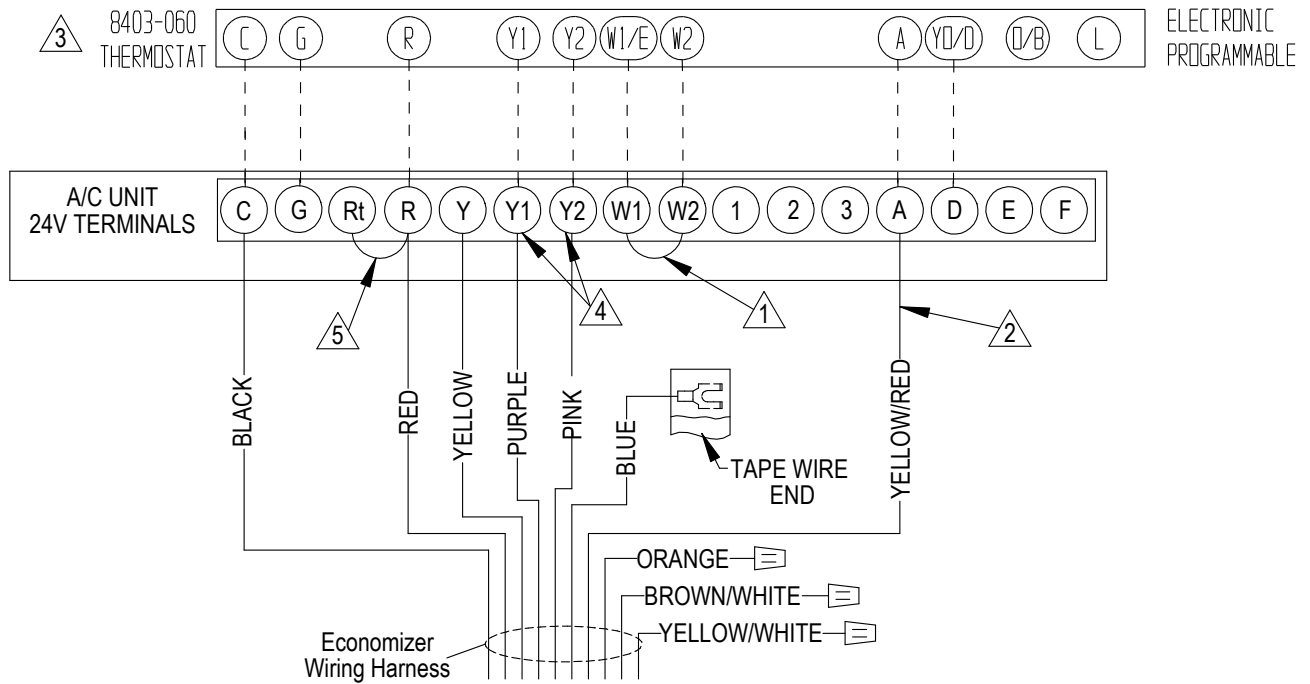

- 1** Factory installed jumper. Remove for 2-stage operation on units with 15 or more kw.
- 2** Must be energized to enable minimum position. NOTE: Economizer Control Default Setting is 10V (100%). Depending upon application may require setting to lower value.
- 3** Change model configuration from heat pump to Heat/Cool, and must be configured from no economizer and multi-stage for Y1 output to be active as first stage cooling and YO/D to be active for humidity control
- 4** Older units may not have Y1 and Y2 connections on 24v terminal block. If not present wire nuts must be used.
- 5** Factory installed jumper. For immediate emergency shutdown of all HVAC operation, remove jumper and connect normally closed (NC) contact to R and Rt terminals.