

---

# INSTALLATION INSTRUCTIONS

---

## ECONOMIZER WITH EXHAUST

### Models:

WGJIFM-3    WGJIFM-5    WGSJIFM-5

For Use with  
Bard 3 – 5 Ton Step Capacity  
and  
2 – 5 Ton Single Stage  
Wall Mount Air Conditioners with Gas Heat



Bard Manufacturing Company, Inc.  
Bryan, Ohio 43506  
[www.bardhvac.com](http://www.bardhvac.com)

Manual: 2100-589C  
Supersedes: 2100-589B  
Date: 8-29-18

Climate Control Solutions

# CONTENTS

---

## General

General Information.....	3
Unpacking.....	3
Description.....	3
Models .....	3

## Installation

Basic Installation .....	4
JADE™ Economizer Controller.....	6
Start-Up/Checkout Procedures.....	6
Enthalpy Settings.....	11
Economizer Features .....	11
Economizer Sequence of Operation	
Cool/Dry Outdoor Ambient Conditions .....	12
Warm/Humid Outdoor Ambient Conditions.....	12
Economizer Operation for Single Stage.....	13
Economizer Operation for Two Stage.....	14
Economizer Sequence of Operation	
Condition A – Cool Outdoors .....	20
Economizer Sequence of Operation	
Condition B – Warm Outdoors .....	21

## Figures

Figure 1	Removal of Exterior Panels.....	4
Figure 2	Installation of Economizer.....	5
Figure 3	Install Loose Piece Wire Harness .....	6
Figure 4	JADE™ Economizer Controller.....	7
Figure 5	100% Outside Airflow Path.....	12
Figure 6	100% Closed Loop Airflow Path .....	12
Figure 7	Call for Blower Operation .....	20
Figure 8	Call for Cooling Operation .....	21
Figure 9	Wiring Diagram (All Models).....	22
Figure 10	Low Voltage Wiring Diagram – 1-Stage A/C w/Gas Heat w/WGJIFM-★Style Economizer .....	23
Figure 11	Low Voltage Wiring Diagram – 2-Stage A/C w/Gas Heat w/WGSJIFM★5 Style Economizer .....	24
Figure 12	Low Voltage Wiring Diagram – 1-Stage A/C w/Dehumidification Gas Heat w/ WGJIFM-★Style Economizer .....	25

## Tables

Table 1	Used w/Models .....	3
Table 2	System Setup .....	7
Table 3	Advanced Setup.....	8
Table 4	Setpoints .....	8
Table 5	Checkout.....	9
Table 6	Status.....	9
Table 7	Alarms .....	10

## Graphs

Graph 1	WG3S Ventilation Airflow .....	15
Graph 2	WG4S Ventilation Airflow .....	15
Graph 3	WG5S Ventilation Airflow .....	16
Graph 4	W24G JIFM Ventilation Airflow .....	17
Graph 5	W30G-W36G JIFM Ventilation Airflow ...	18
Graph 6	W42G-W60G JIFM Ventilation Airflow ...	19

**BARD MANUFACTURING COMPANY, INC.**  
**BRYAN, OHIO USA 43506**

## GENERAL INFORMATION

The ventilator should only be installed by a trained heating and air conditioning technician. These instructions serve as a guide to the technician installing the ventilator package. They are not intended as a step by step procedure with which the mechanically inclined owner can install the package.

The ventilator housing is shipped in one carton which contains the electrical harness, miscellaneous hardware and installation instructions.

The economizer installation will function normally with the 2-stage thermostats already specified for usage with this 2-stage cooling unit.

If the "free cooling" of the economizer cannot keep up with the cooling demand, the compressor will then operate on 2nd stage mechanical cooling call.

**Because of this, all units equipped with an economizer need to be equipped with the low ambient control.** For field installed applications, install Bard Low Ambient Control Kit:

W24G - W60G	CMA-6
WG3S - WG5S	CMA-28
W24G*D - W60G*D	CMA-28

If using a Bard Master Controller, the Bard MC4000 controller is designed to control two (2) redundant Bard Wall Mount units equipped with economizers. Refer to the MC4000 Installation Manual (or consult Bard Technical Service) for the required connections and sequence of operation.

## UNPACKING

Upon receipt of the equipment be sure to compare the model number found on the shipping label with the accessory identification information on the ordering and shipping document to verify that the correct accessory has been shipped.

Inspect the carton housing of each ventilator as it is received, and before signing the freight bill, verify that all items have been received and that there is no visible damage. Note any shortages or damage on all copies of the freight bill. The receiving party must contact the last carrier immediately, preferably in writing, requesting inspection by the carrier's agent. Concealed damage not discovered until after loading must be reported to the carrier within 15 days of its receipt.

## DESCRIPTION

The WGJIFM-3 economizer is designed to be used with Bard W24G to W36G 1-stage cooling, 1-stage heating gas electric model wall mounts that are equipped with fan cycling controls; the WGJIFM-5 economizer is designed to be used with Bard W48G to W60G 1-stage cooling, 1-stage heating gas electric model wall mounts that are equipped with fan cycling controls and the WGSJIFM-5 economizer is designed to be used with Bard WG\*S 2-stage cooling wall mounts that are equipped with fan cycling controls.

These are electromechanical economizer systems designed to provide "free" cooling where the outdoor air temperature is cool enough to provide the needed cooling without running the compressor. When cooling is needed, the system automatically takes advantage of the cold outdoor air when available, and uses it for first stage cooling. This operation reduces the need to run the air conditioning compressor, providing lower operating costs and increasing the service life of the equipment. If the outdoor air gets too warm or humid to be helpful, the enthalpy control detects the condition and automatically operates the internal damper and switches on the mechanical cooling. This is all accomplished automatically without attention from the user to achieve maximum savings.

Reference pages 13 and 14 for block diagrams of the economizer operation logic flow. These units are equipped with full modulating type damper motors, which control the damper position to a factory set minimum supply air temperature.

## MODELS

When installed in model series (see Table 1), all JIFM models provide built in exhaust provisions. When the damper blade opens to bring fresh air in, the damper also opens an exhaust relief. The exhaust air will flow into the condenser section of the unit. The condenser fan will help draw exhaust air out.

TABLE 1

WGSJIFM-5	WG3S WG4S WG5S
WGJIFM-3	W24G W30G W36G
WGJIFM-5	W42G W48G W60G

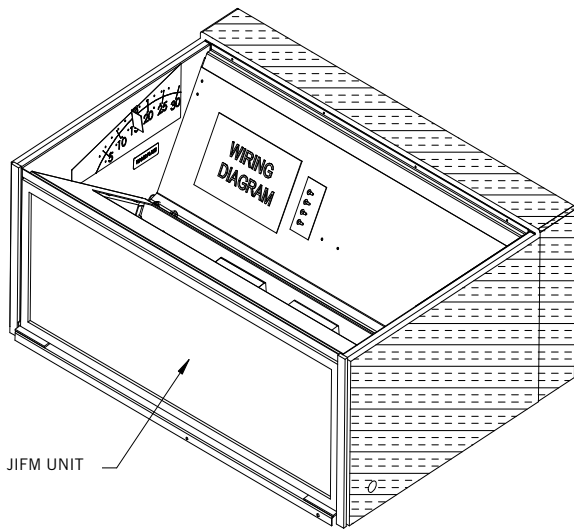
# INSTALLATION

## **WARNING**

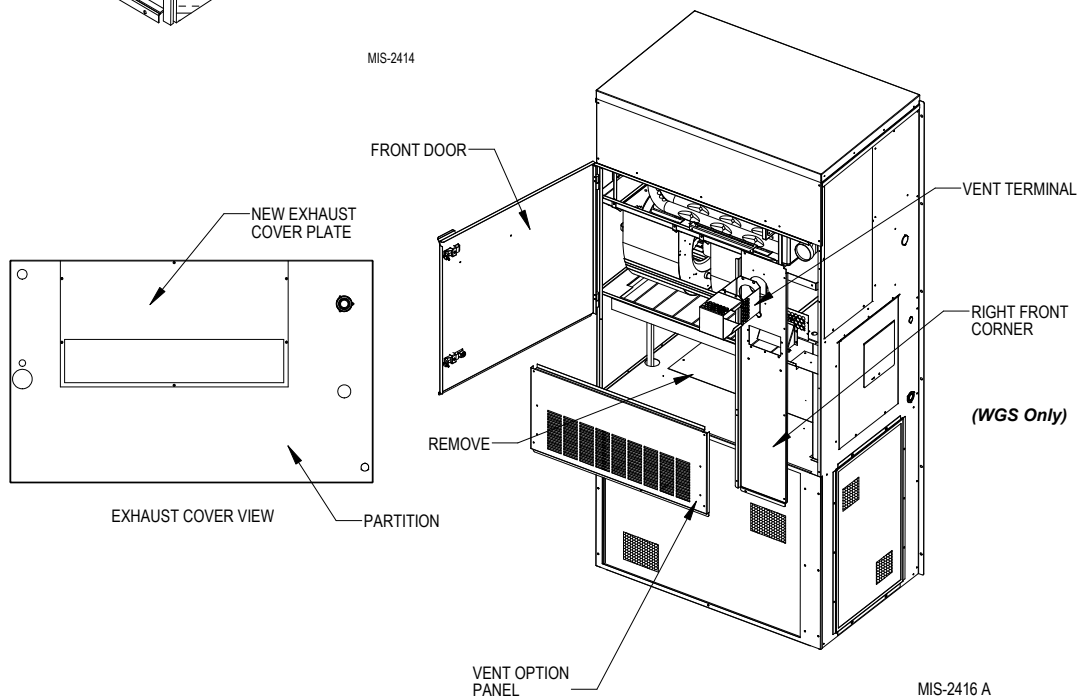
*Open and lock unit disconnect switch before installing this accessory to prevent injury or death due to electrical shock or contact with moving parts. Turn the thermostat to off.*

### **BASIC INSTALLATION**

1. Unpack the ventilator assembly which includes the integral ventilator with attached electrical harness, exhaust opening adapter plate and miscellaneous hardware.
2. Remove and save the existing exterior blower access and service access panels (see Figure 1). For the WGSJIFM model only, remove the right front cover.
3. Remove and discard exhaust cover plate.
4. In rear of opening towards duct connection, install exhaust opening adaptor plate (included).



**FIGURE 1**  
**Removal of Exterior Panels**

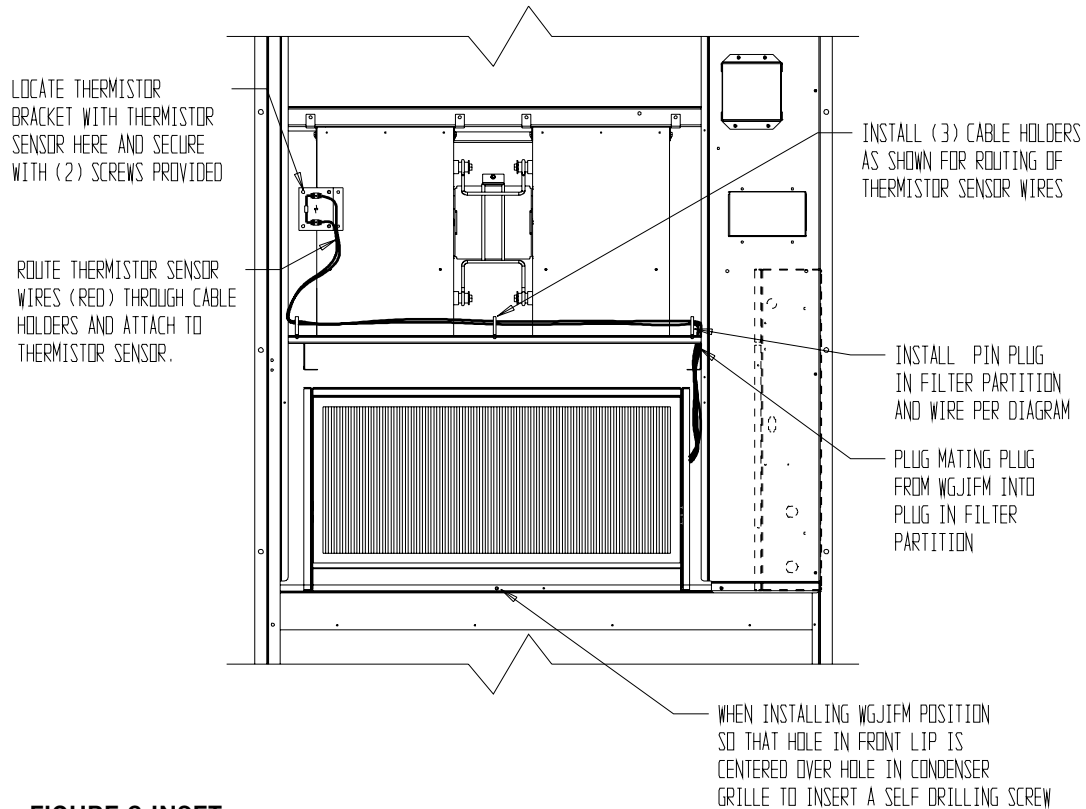


5. Install ventilator sheet metal assembly by inserting the ventilator into the unit, centering between the tubing on the left and the control panel on the right. Once the ventilator is fully inserted, slide the ventilator to align screw hole through the front of the condenser grille. (See Figure 2.)

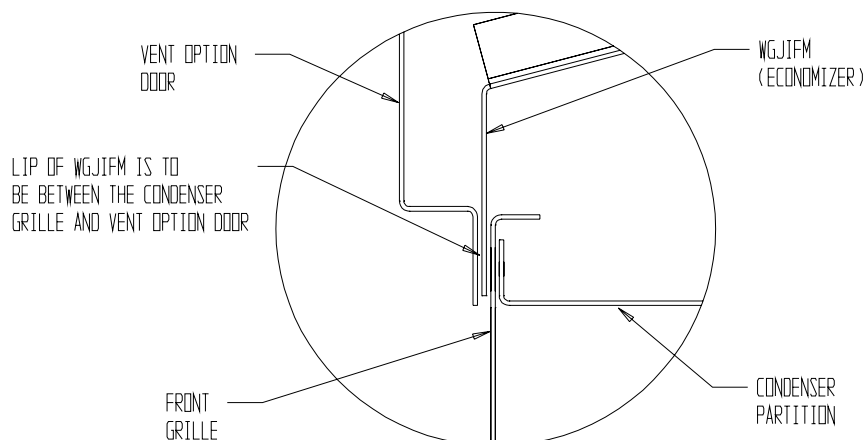
**IMPORTANT:** Position front lip of ventilator on top of front grille and condenser partition. (See Figure 2 inset.) This is important to ensure proper drainage of any water entering damper assembly.

6. Open control panel to gain access to unit low voltage terminal block.
7. Install loose piece wire harness plug into filter tray and route wires into low volt box. (See Figure 3 on page 6.) Save back two (2) long red wires with push-on terminals.)
8. Plug wire plug from vent package installed in Steps #1 through #6 into plug installed in Step #7.

**FIGURE 2**  
**Installation of Economizer**

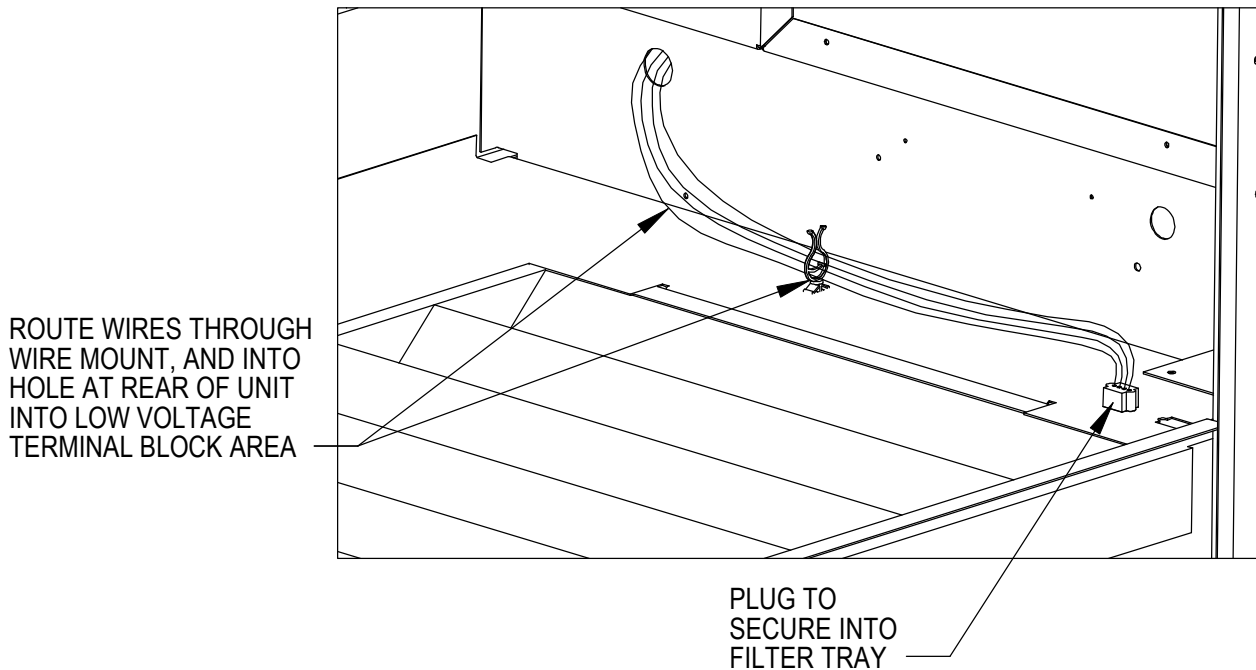


**FIGURE 2 INSET**  
**SIDE SECTION**



MIS-1625 B

**FIGURE 3**  
**Install Loose Piece Wire Harness Plug**



MIS-2415

9. Mount mixed air thermistor sensor to blower as shown with screws provided as shown in Figure 2 on page 4. Route two (2) red wires from wire harness installed in Step #7 through cable holders and connect to thermistor sensor.
10. Connect the wires (with fork connectors) routed into the low voltage box in Step #7 to the low voltage terminal strip per the appropriate wiring diagram (refer to pages 23-25).
11. Replace right front unit corner and vent terminal.
12. Close upper unit door to seal blower discharge air.
13. See Start-Up/Checkout Procedures on next page to activate and verify economizer functions.

### **JADE™ ECONOMIZER CONTROLLER**

W7220 controller offers unparalleled flexibility and expansion in a dependable and solid electronic platform.

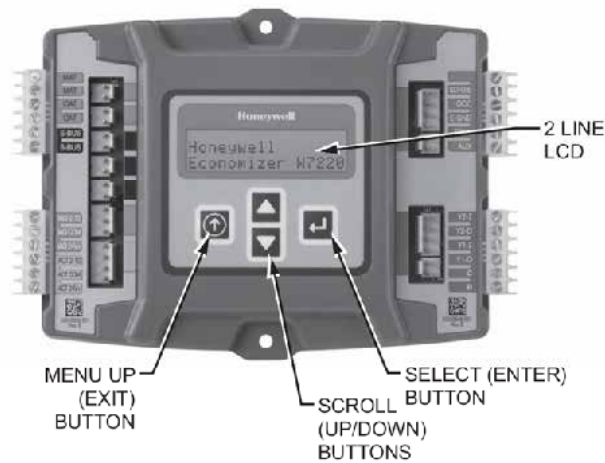
- Multiple economizer applications from one controller.
- Nearly limitless customization of setpoints.
- Internal checkout menu provides fast performance assessment.
- Alarms menu provides assistance in troubleshooting.

**Memory:** User defined setpoints remain in non-volatile flash memory regardless of electrical outage duration. Control voltage below 18V may cause erratic performance.

### **START-UP/CHECKOUT PROCEDURES**

The **JADE™** economizer controller is preset with “default” values that were pre-determined as optimum for school buildings, and these are shown in Tables 2-4 on the following pages. It is important to review and/or customize these operational values per owner specifications in order to guarantee satisfactory performance. The installing contractor can easily access the **JADE™** programming by the integral keypad and LCD display.

**FIGURE 4**  
**JADE™ Economizer Controller**



There are six (6) basic MENU categories to navigate:

1. **STATUS** – provides real-time access to sensor input, damper and equipment operation.
2. **SETPOINTS** – customizable operational parameters.
3. **SYSTEM SETUP** – customizable application programming.
4. **ADVANCED SETUP** – further application and operational options.
5. **CHECKOUT** – instantly activate and verify economizer functions.
6. **ALARMS** – displays alarms and pinpoints problem areas.

Before being placed in service, the **JADE™** economizer controller programming should be reviewed/customized through the following steps:

1. **SYSTEM SETUP:** from the main screen, press the **SCROLL (UP/DOWN) BUTTONS** to navigate through the six (6) basic menu items to the **SYSTEM SETUP** menu.
  - Push the **SELECT (ENTER) BUTTON** to choose the **SYSTEM SETUP** menu.
  - Navigate through the multiple levels of **SYSTEM SETUP** by pushing the **SCROLL (UP/DOWN) BUTTONS**.
  - To change a specific parameter in the **SYSTEM SETUP** menu, press the **SELECT (ENTER) BUTTON** to display its current value. Press the **SCROLL (UP/DOWN) BUTTONS** to change or increase/decrease value. Press the **SELECT (ENTER) BUTTON** to save the new customized value—“CHANGE STORED” will be displayed. Press the **SELECT (ENTER) BUTTON** again to return to current menu parameter.

- For specific **SYSTEM SETUP** level information, refer to **Table 2**.

**NOTE:** During an extended level of inactivity, the display of the **JADE™** economizer controller will begin to automatically scroll through the various levels of the **STATUS** menu as a screensaver. Each level will stay for approximately 5 seconds before changing to the next level.

**TABLE 2**  
**System Setup (Menu Levels)**

Menu Level	Default Value	Range	Notes
INSTALL	01/01/10		Display Order = MM/DD/YY Setting Order = DD/MM/YY
UNITS DEG	°F	°F / °C	Sets controller to read in either measurements
EQUIPMENT	HP(B)	HP	Heat Pump HP * CONV = A/C
AUX IN	HP(B)	HP (O) HP (B)	Energize on Cool * Energize on Heat
FAN SPEED	1 Speed	1 Speed 2 Speed	
FAN CFM	5000	100 to 15,000	Not applicable
AUX OUT	EXH2	NONE ERV EXH2 SYS	Product can be used to signal other devices
OCC	INPUT	INPUT or ALWAYS	INPUT is for dedicated OCC signal, ALWAYS is for all other situations
FACTORY DEFAULT	NO	YES or NO	Resets to factory defaults if changed to YES

- \* **In SYS SETUP the correct equipment setting is HP and for the AUX2 IN is HP (B) in all applications.** This is correct for both air conditioner and heat pump equipment in order to have correct operating sequences for the economizers. DO NOT change to CONV = A/C setting just because the equipment is an air conditioner and not a heat pump.
- 2. **ADVANCED SETUP:** from the main screen, press the **SCROLL (UP/DOWN) BUTTONS** to navigate through the six (6) basic menu items to the **ADVANCED SETUP** menu.
  - Push the **SELECT (ENTER) BUTTON** to choose the **ADVANCED SETUP** menu.
  - Navigate through the multiple levels of **ADVANCED SETUP** by pushing the **SCROLL (UP/DOWN) BUTTONS**.
  - To change a specific parameter in the **ADVANCED SETUP** menu, press the **SELECT (ENTER) BUTTON** to display its current value. Press the **SCROLL (UP/DOWN) BUTTONS** to change or increase/decrease value. Press the **SELECT (ENTER) BUTTON** to save the new

customized value—“CHANGE STORED” will be displayed. Press the **SELECT (ENTER) BUTTON** again to return to current menu parameter.

- For specific **ADVANCED SETUP** level information, refer to **Table 3**.

**TABLE 3**  
**Advanced Setup (Menu Levels)**

Menu Level	Default Value	Range	Notes
MA LOW SET	45°F	35-55°	Temp to activate freeze protection — Close Damper
FREEZE POS	CLO	CLO or MIN	Damper position upon freeze protection
STG3 DLY	15 Min.	0 to 4.0h or OFF	Delay for 3 <sup>rd</sup> Stage Cooling – allows for 3 stages of cooling, one stage for econ & two stages for compressor
DMPR POS	CLO	CLO or OPN	Where damper goes upon shutdown signal
MA T CAL	0.0°F	+/-2.5°F from actual reading	Mixed Air Sensor temperature calibration
OA T CAL	0.0°F	+/-2.5°F from actual reading	Outdoor Air Sensor temperature calibration
OAS H CAL	0%	+/-10% from actual reading	Outdoor Air Humidity Sensor calibration for economizers using temp/humidity sensor

3. **SETPOINTS:** from the main screen, press the **SCROLL (UP/DOWN) BUTTONS** to navigate through the six (6) basic menu items to the **SETPOINTS** menu.
  - Push the **SELECT (ENTER) BUTTON** to choose the **SETPOINTS** menu.
  - Navigate through the multiple levels of **SETPOINTS** by pushing the **SCROLL (UP/DOWN) BUTTONS**.
  - To change a specific parameter in the **SETPOINTS** menu, press the **SELECT (ENTER) BUTTON** to display its current value. Press the **SCROLL (UP/DOWN) BUTTONS** to change or increase/decrease value. Press the **SELECT (ENTER) BUTTON** to save the new customized value—“CHANGE STORED” will be displayed. Press the **SELECT (ENTER) BUTTON** again to return to current menu parameter.
  - For specific **SETPOINTS** level information, refer to **Table 4**.

**NOTE:** At this point, the economizer assembly should be fully functional and ready for preliminary testing.

**TABLE 4**  
**Setpoints (Menu Levels)**

Menu Level	Default Value	Range	Notes
MA T SET	53°F	38°F to 65°F	Mixed Air Temperature setpoint at which the economizer damper will begin to modulate to maintain setting
LOW T LOCK	0°F	-45°F to 80°F	Low outdoor ambient temperature for compressor lockout
DRYBLB SET	60°F	48°F to 80°F	Maximum outdoor temperature setting for "free" economizer cooling
ENTH CURVE	ES3	ES1, ES2, ES3, ES4 or ES5	Enthalpy boundary "curves" for economizers using temp/humidity sensor, see "Enthalpy Settings" explanation
MIN POS	2.0V	2 to 10 VDC	Actuator voltage for Minimum Position
EXH1	50%	0 to 100%	Setpoint for damper if exhaust fan is powered by economizer
EXH2	6%	0 to 100%	Setpoint for AUX output signal

4. **CHECKOUT:** from the main screen, press the **SCROLL (UP/DOWN) BUTTONS** to navigate through the six (6) basic menu items to the **CHECKOUT** menu.
  - Push the **SELECT (ENTER) BUTTON** to choose the **CHECKOUT** menu.
  - Navigate through the multiple levels of **CHECKOUT** by pushing the **SCROLL (UP/DOWN) BUTTONS**.
  - To perform a specific test in the **CHECKOUT** menu, press the **SELECT (ENTER) BUTTON** to choose a particular exercise, “RUN?” will appear. Press the **SELECT (ENTER) BUTTON** again to activate this exercise. After a short pause, “IN PROGRESS” will appear as the test activates. “DONE” will display after the test is complete. Press the **MENU UP (EXIT) BUTTON** to end the test and/or turn off the activated relay.
  - For specific **CHECKOUT** level information, refer to **Table 5**.

**NOTE: CHECKOUT** functions bypass the normal 5-minute delay for compressor protection. Be sure to allow for enough time to pass between tests so the compressor is not damaged from extreme short-cycling

**NOTE:** Economizer assembly should be ready to put into service. At any point during operation, in economizer mode or idle, real-time information from sensors and integral components can be accessed from the **STATUS** menu.



**TABLE 5**  
**Checkout (Menu Levels)**

Menu Level	Notes
DAMPER VMIN-HS	Positions damper to the minimum amount of opening allowed by actuator
DAMPER VMAX-HS	Opens damper to the MIN POS level indicated in the <b>SETPOINTS</b> menu. See Minimum Position Ventilation Setup Procedure (Pg. 16)
DAMPER OPEN	Forces damper to full open position, energizes exhaust contacts
DAMPER CLOSE	Positions damper to completely closed position
CONNECT Y1-O	Forces Y1-OUTPUT to compressor
CONNECT Y2-O	Forces Y2-OUTPUT to compressor
CONNECT AUX	Depending upon AUX OUT setting from <b>SETUP</b> menu: NONE – no action ERV – 24VAC out for ERV & NOT Economizer SYS – 24VAC out for alarm

5. **STATUS:** from the main screen, press the **SCROLL (UP/DOWN) BUTTONS** to navigate through the six (6) basic menu items to the **STATUS** menu.
- Push the **SELECT (ENTER) BUTTON** to choose the **STATUS** menu.
  - Navigate through the multiple levels of **STATUS** by pushing the **SCROLL (UP/DOWN) BUTTONS**.
  - As the **STATUS** menu simply gives input/output information in real-time, there is no way to change or otherwise alter the displayed criteria. It is simply a window into the operation of the economizer controller.
  - For specific **STATUS** level information, refer to **Table 6**.

**NOTE:** Upon power-up (or after power failure or low voltage condition), the controller will begin a 5-minute time delay before enabling mechanical cooling.

**TABLE 6**  
**Status (Menu Levels)**

Menu Level	Range	Notes
ECON AVAIL	YES/NO	Indicates if conditions are favorable for economizing
ECONOMIZING	YES/NO	Indicates if economizer is actively economizing
OCCUPIED	YES/NO	Indicates if dedicated 24V occupied signal is being received on terminal OCC
HEAT PUMP	COOL/HEAT	Displays actual compressor use if in HEAT PUMP mode
COOL Y1-IN	ON/OFF	Indicates if 24V signal is being received on terminal Y1-I
COOL Y1-OUT	ON/OFF	Displays if controller is actively calling for mechanical compressor cooling (24V on Y1-O)
COOL Y2-IN	ON/OFF	Indicates if 24V signal is being received on terminal Y2-I
COOL Y2-OUT	ON/OFF	Displays if controller is actively calling for Stg. 2 cooling (24V on Y2-O)
MA TEMP	0° to 140°F	Current mixed air temp
OA TEMP	-40° to 140°F	Current outdoor air temp
OA HUM	0% to 100%	Current outdoor air humidity for economizers using temp/humidity sensor
DAMPER OUT	2.0 to 10.0	Displays voltage to actuator
ACT POS	0 to 100%	Current % of opening
ACT COUNT	N/A	Current count of actuator cycles from installation
ACTUATOR OK	YES/NO	Indicates potential fault
EXH1 OUT	ON/OFF	Output of EXH1 Terminal
MECH COOL ON	0, 1, or 2	Stages of mechanical cooling currently active

6. **ALARM(S)**: from the main screen, press the **SCROLL (UP/DOWN) BUTTONS** to navigate through the six (6) basic menu items to the **ALARM(S)** menu.
- Push the **SELECT (ENTER) BUTTON** to choose the **ALARM(S)** menu.
  - Navigate through the current alarms in **ALARM(S)** by pushing the **SCROLL (UP/DOWN) BUTTONS**.
  - Once the alarm has been identified, and the cause has been removed (e.g., replaced faulty sensor), the alarm may erase itself. If a manual alarm-erasing is required, it can be cleared from the display by navigating to the desired alarm and pressing the **SELECT (ENTER) BUTTON** to choose that specific alarm. “ERASE?” will display. Press the **SELECT (ENTER) BUTTON** again. “ALARM ERASED” will appear. Press the **MENU UP (EXIT) BUTTON** to complete the action and return to the previous menu.
  - For specific **ALARM(S)** information, refer to **Table 7**.

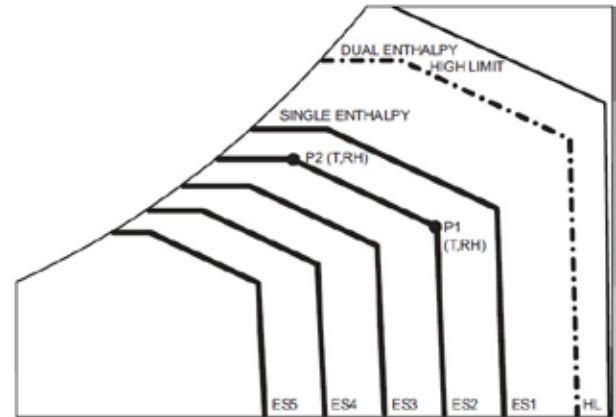
**NOTE:** If there are any potential problems recognized by the economizer controller, it may be registered in the form of an alarm in the **ALARM(S)** menu. If there is a period of inactivity AND there is an alarm registering, the controller will randomly scroll through the **ALARM(S)** menu items as a screensaver.

**TABLE 7**  
**Alarms (Examples)**

<b>Alarm(s)</b>	<b>Notes</b>
MA T SENS ERR	Malfunctioning mixed air sensor
OA T SENS ERR	Malfunctioning outdoor air sensor
ACT STALLED	Actuator cannot reach desired percentage of opening
SYS ALARM	If AUX is set to SYS in SETPOINTS menu, SYS will display upon any registered alarm
NOTE: This is not a complete list of alarms. Additional alarms will display depending upon the parameter settings and configuration and attached equipment.	

## ENTHALPY SETTINGS

If economizer is enthalpy-based, and was shipped with the temp/humidity sensor, the economizer must be programmed for the specific enthalpy curve boundary desired for “free” outdoor cooling. The available enthalpy boundaries are all subject to specific outdoor ambient (OA) temperature, OA humidity and OA dew points. If all of the OA conditions are below the specific points outlined in each boundary, the conditions are good to economize and economizer mode is set to “YES”. If some or all the OA conditions are above the specific points outlined in each boundary, the conditions are not good to economize and the economizer mode is set to “NO”.



Enthalpy Curve	Temp. Dry Bulb (°F)	Temp. Dewpoint (°F)	Enthalpy (btu/lb/da)	Point P1		Point P1	
				Temp. °F	Humidity % RH	Temp. °F	Humidity % RH
ES1	80.0	60.0	28.0	80.0	36.8	66.3	80.1
ES2	75.0	57.0	26.0	75.0	39.6	63.3	80.0
ES3	70.0	54.0	24.0	70.0	42.3	59.7	81.4
ES4	65.0	51.0	22.0	65.0	44.8	55.7	84.2
ES5	60.0	48.0	20.0	60.0	46.9	51.3	88.5
HL	86.0	66.0	32.4	86.0	38.9	72.4	80.3

## ECONOMIZER FEATURES

- One piece construction—easy to install. Direct-drive actuator eliminates linkage.
- Exhaust air damper built in with positive closed position. Provides exhaust air capability to prevent pressurization of tight buildings.
- **JADE™** controller provides nearly limitless customization on a solid, intuitive electronic platform.
- Actuator Motor: 24 volt, power-open, spring-return, direct-coupled with stall protection. Self-centering shaft clamp and access cover facilitate ease of replacement/maintenance.
- Proportioning-type control for maximum “free” cooling economy and comfort with up to 75% outdoor air.
- Enthalpy sensor to monitor outdoor air temperature.
- Minimum Ventilation Position available for required ventilation of occupants or dilution of pollutants.
- Mixed air sensor to monitor outdoor and return air to automatically modulate damper position.

## ECONOMIZER SEQUENCE OF OPERATION

### Condition – Cool/Dry Outdoor Ambient Conditions

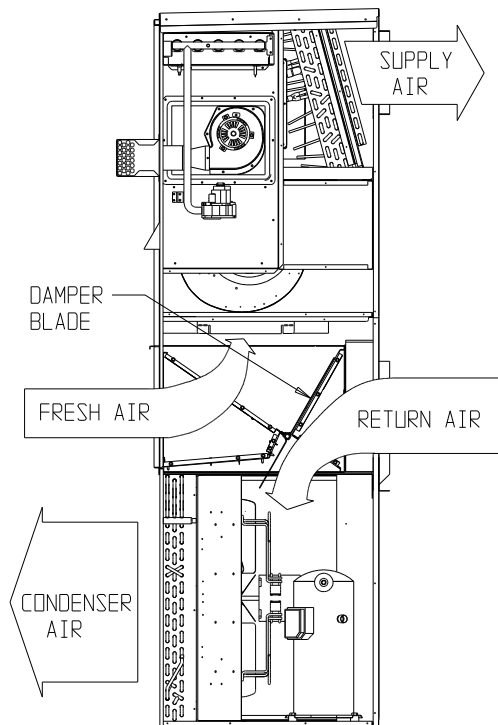
- 1<sup>st</sup> Stage Cooling closes and sends signal to **JADE™** control. Since the air temperature outside is cooler than the preset **DRYBULB SET** setting, or is below the **ENTH CURVE** boundary in the **SETPOINTS** menu, the actuator will power the economizer damper to “economizer” mode as the indoor blower motor starts. The mixed air sensor senses a mixture of return air and cool outdoor air and modulates opening to achieve preset **MAT SET** setting in **SETPOINTS** menu. Compressor operation is inhibited. (See Figure 5.)
- 2<sup>nd</sup> Stage Cooling closes and sends a signal to **JADE™** control, which closes the Y1-O relay to begin mechanical cooling. **The economizer damper REMAINS OPEN in tandem operation with the compressor** as long as the OA conditions do not drop below the preset **DRYBULB SET/ENTH CURVE** settings in the **SETPOINTS** menu.
- 3<sup>rd</sup> Stage Cooling (if available) closes and sends a signal to **JADE™** control, which closes the Y2-O relay to begin 2<sup>nd</sup> stage mechanical cooling. **The economizer damper REMAINS OPEN in tandem operation with the compressor** as long as

the temperature outside does not drop below the preset **DRYBULB SET** setting in the **SETPOINTS** menu.

### Condition – Warm/Humid Outdoor Ambient Conditions

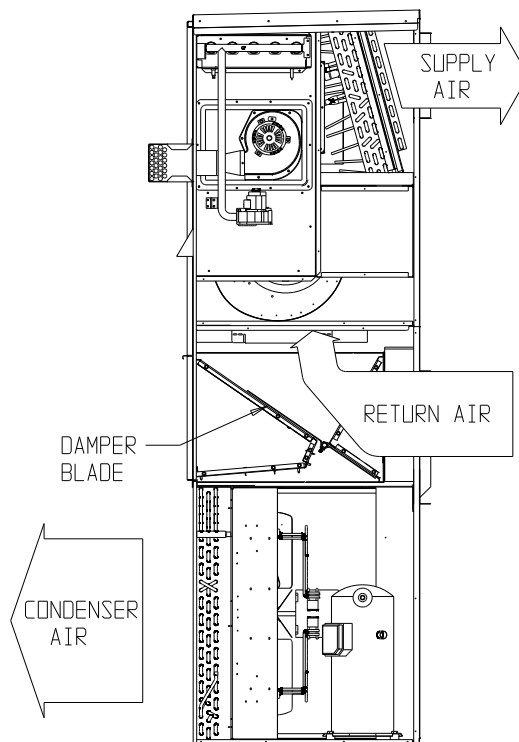
- 1<sup>st</sup> Stage Cooling closes and sends signal to **JADE™** control. Since the outdoor air conditions are above the preset **DRYBULB SET/ENTH CURVE** setting in the **SETPOINTS** menu, the control will simply close the Y1-O relay to initiate mechanical cooling. **The economizer damper will remain closed or in a minimum ventilation setting depending upon occupied status.** (See Figure 6.)
- 2<sup>nd</sup> Stage Cooling (if available) closes and sends a signal to **JADE™** control. Since the outdoor air conditions are still above than the preset **DRYBULB SET/ENTH CURVE** setting in the **SETPOINTS** menu, the control will simply close the Y2-O relay to initiate 2<sup>nd</sup> stage mechanical cooling. **The economizer damper will remain closed or in a minimum ventilation setting depending upon occupied status.**

**FIGURE 5**  
100% Outside Airflow Path



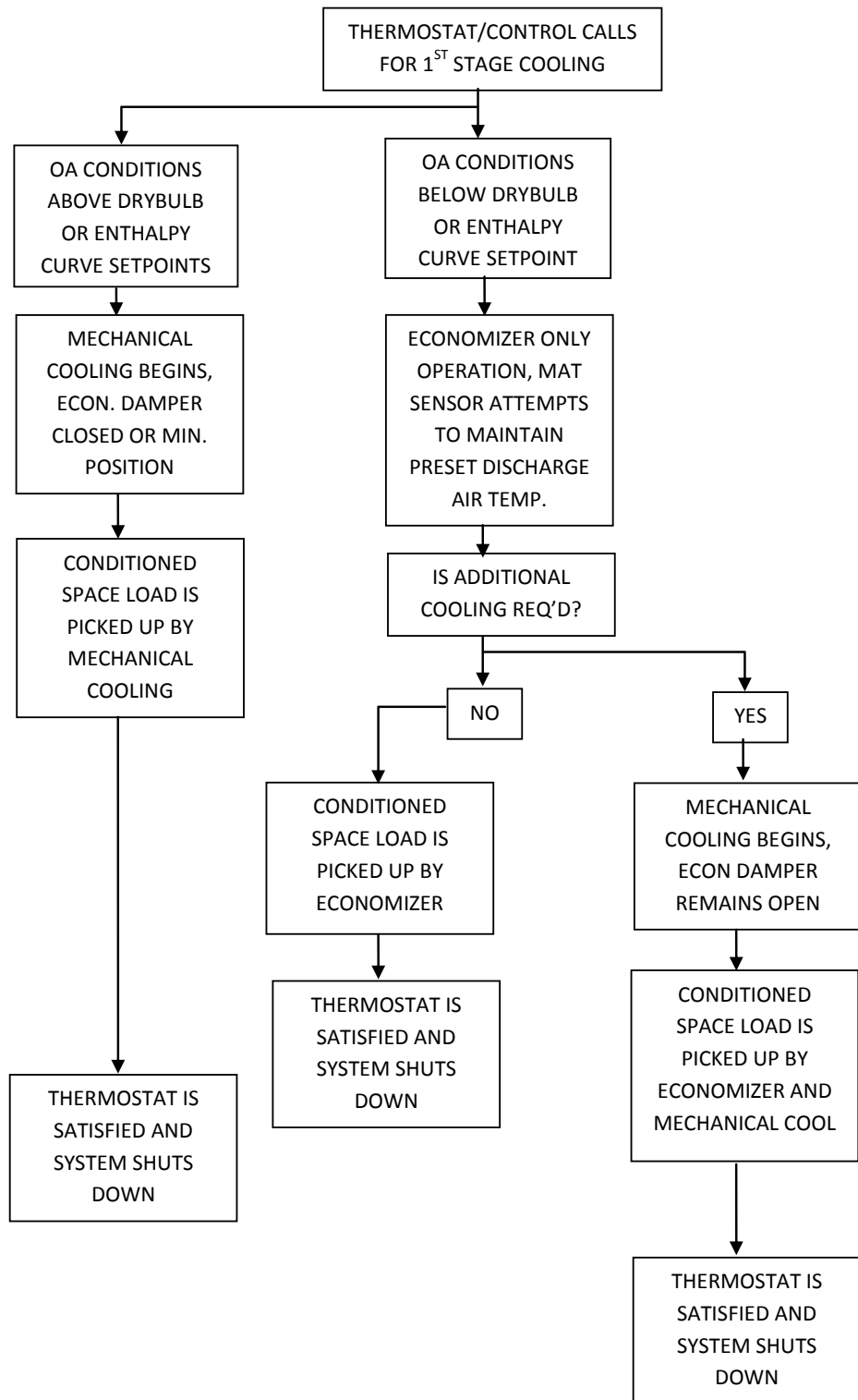
MIS-2413

**FIGURE 6**  
100% Closed Loop Airflow Path

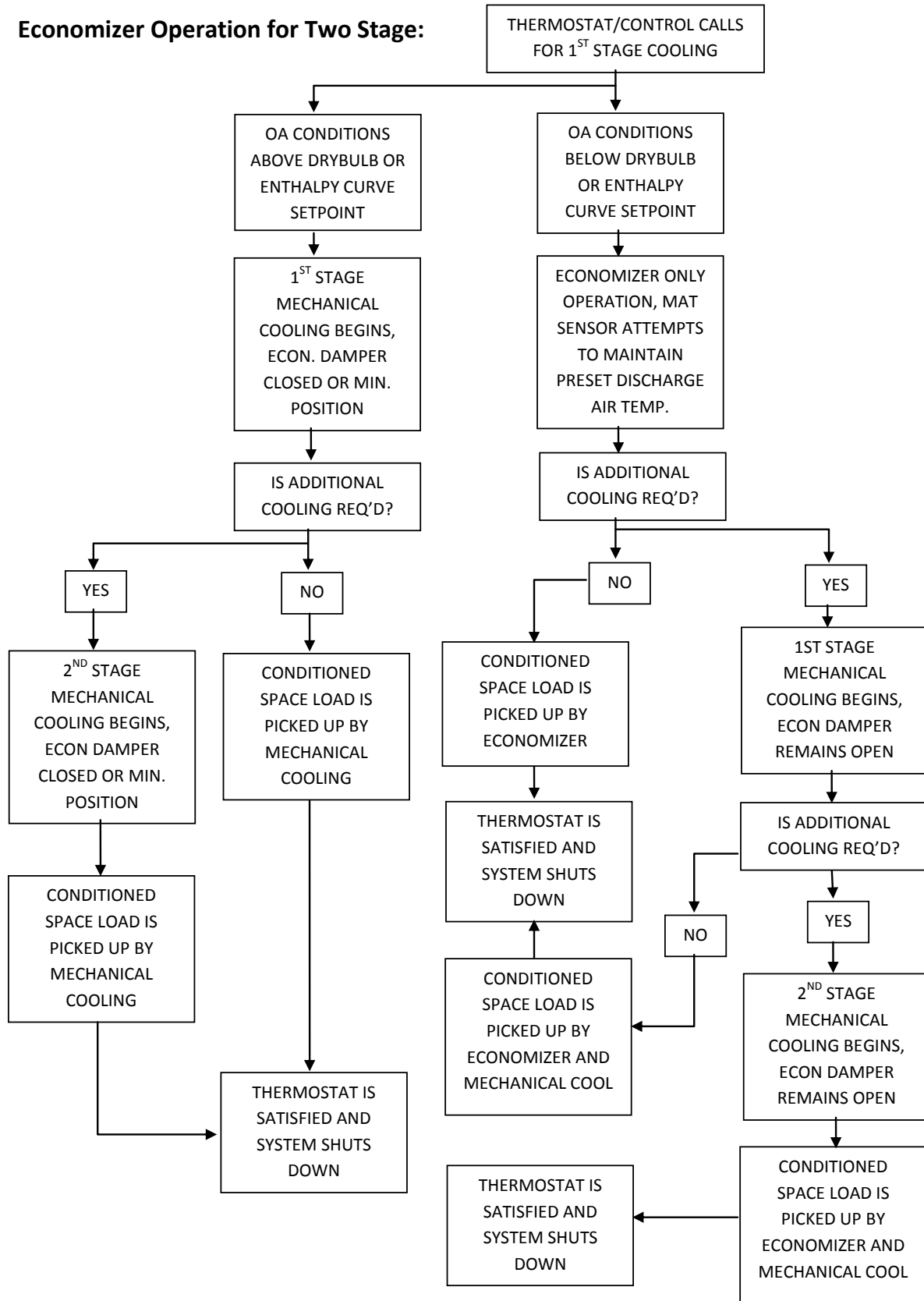


MIS-2412 A

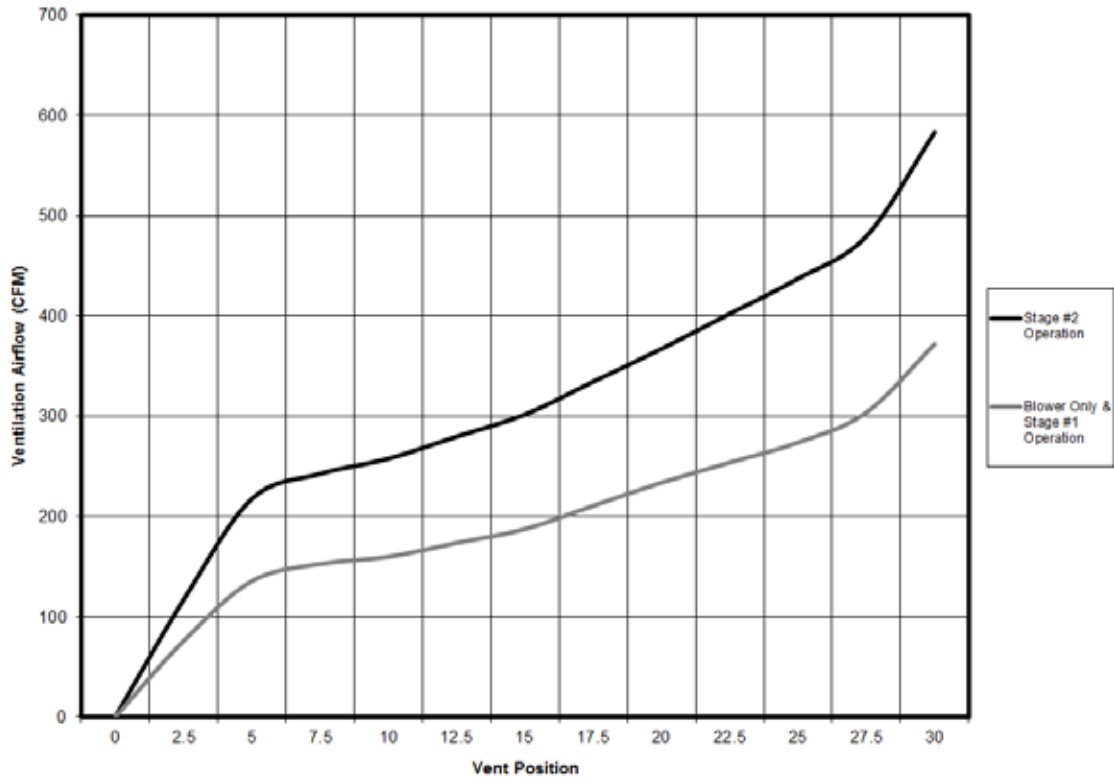
## Economizer Operation for Single Stage:



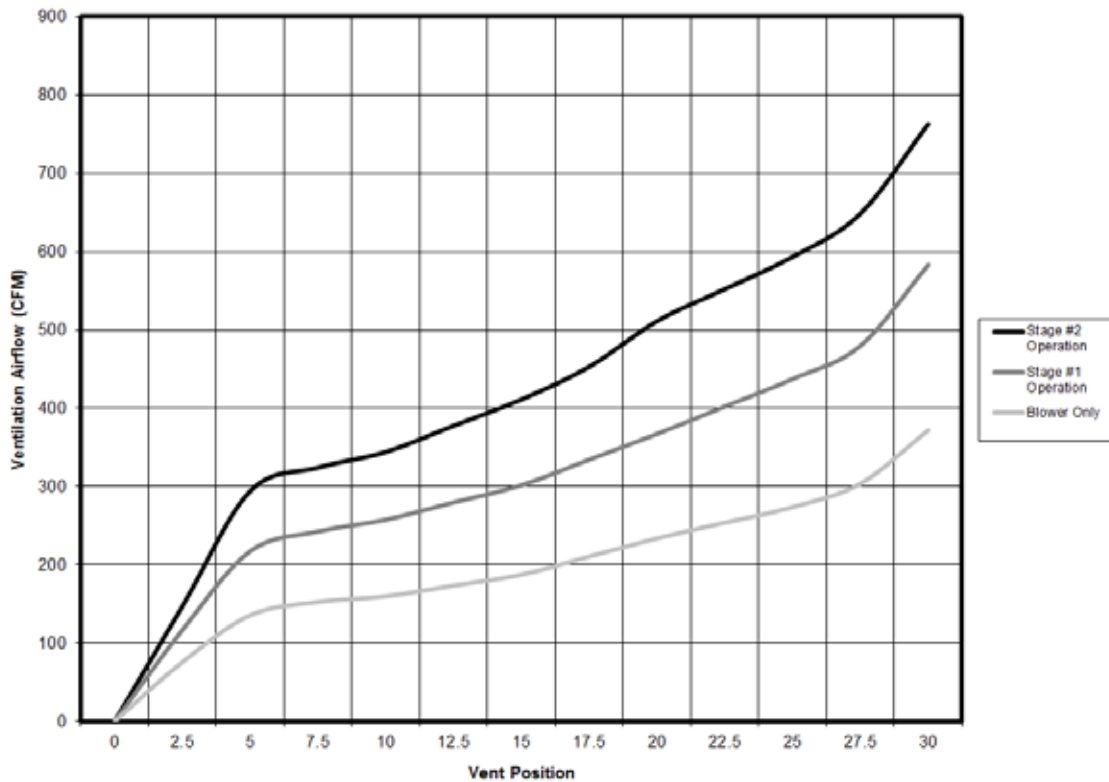
## Economizer Operation for Two Stage:



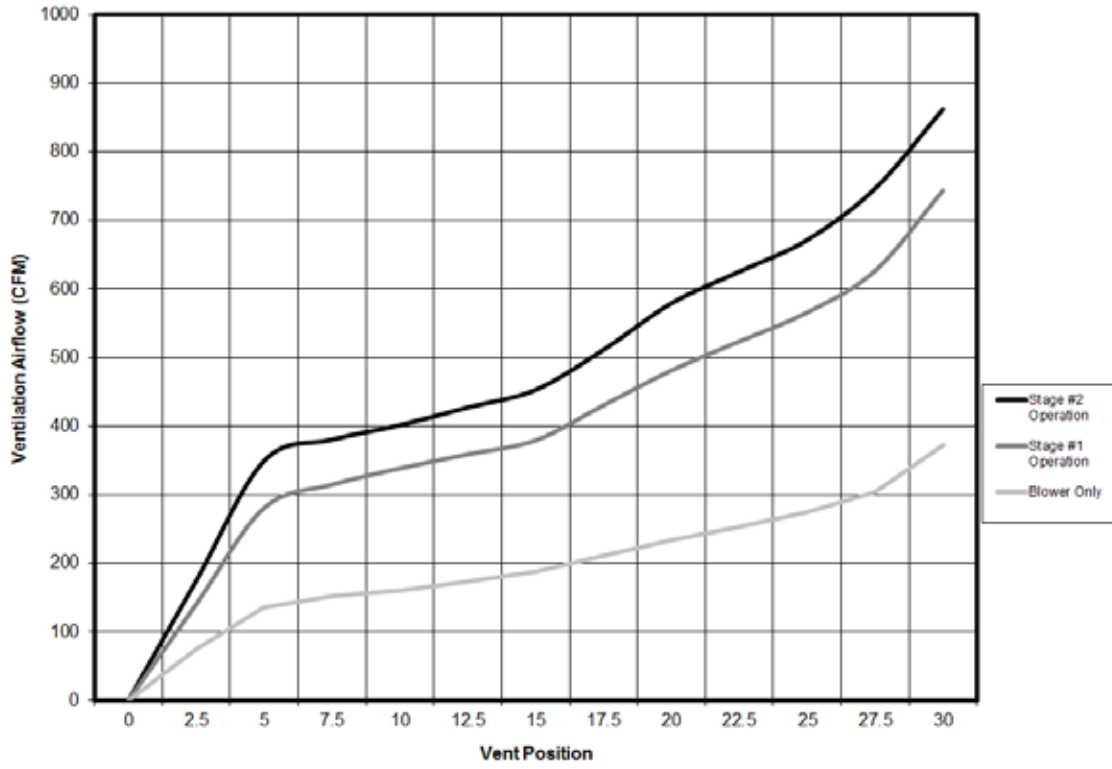
**GRAPH 1  
WG3S VENTILATION AIRFLOW**



**GRAPH 2  
WG4S VENTILATION AIRFLOW**

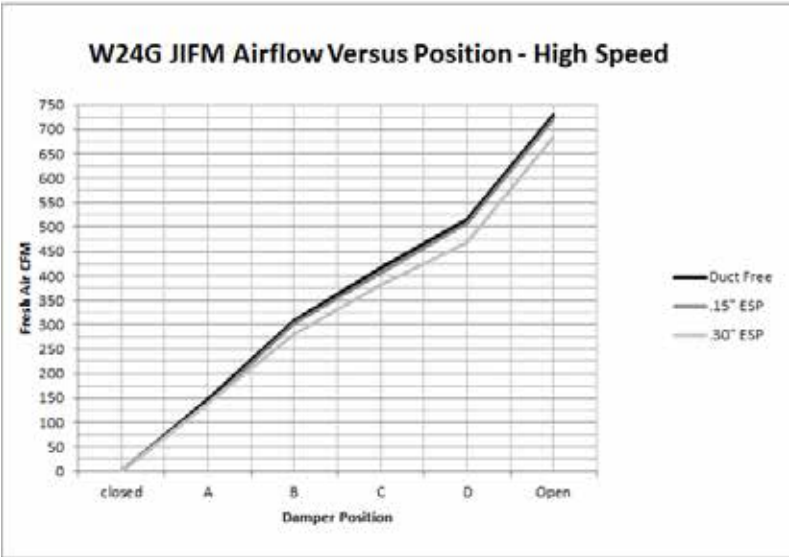
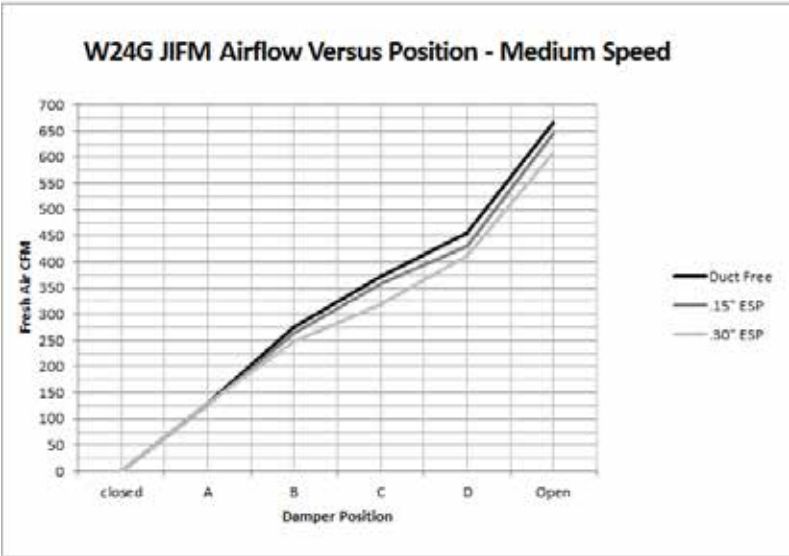
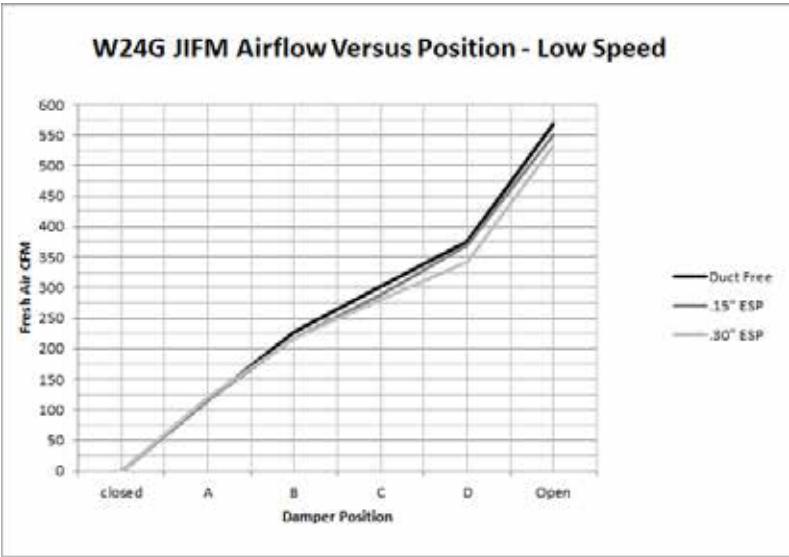


GRAPH 3  
WG5S VENTILATION AIRFLOW

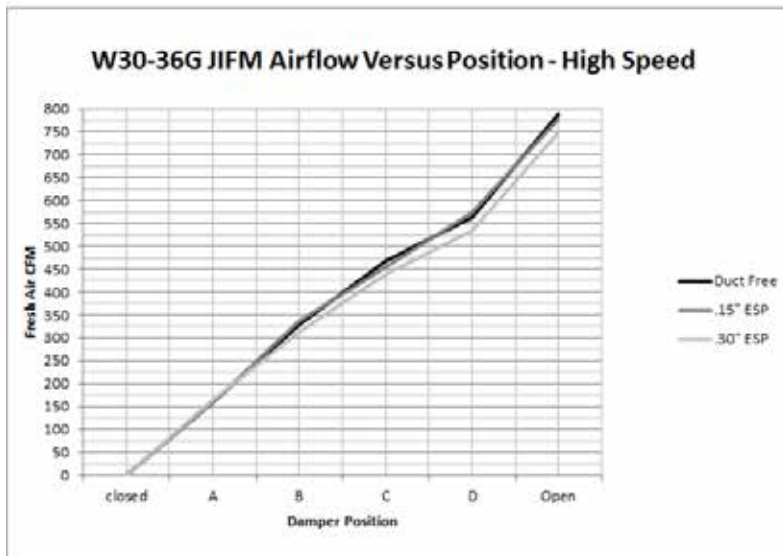
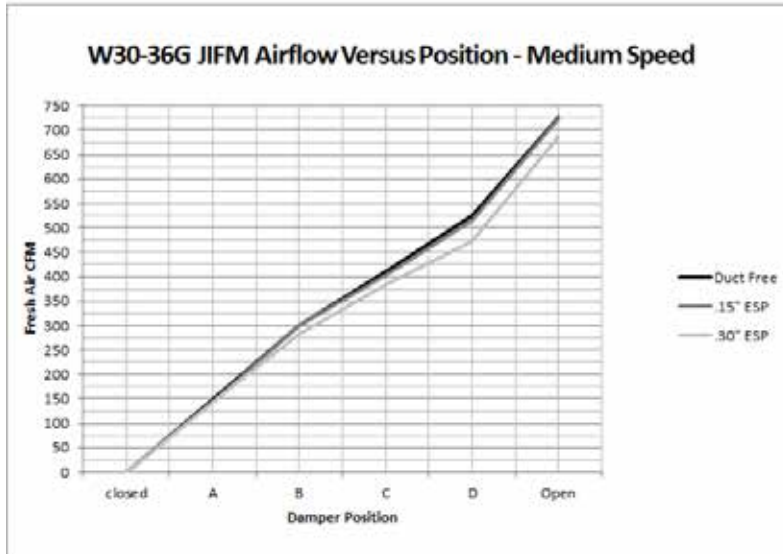
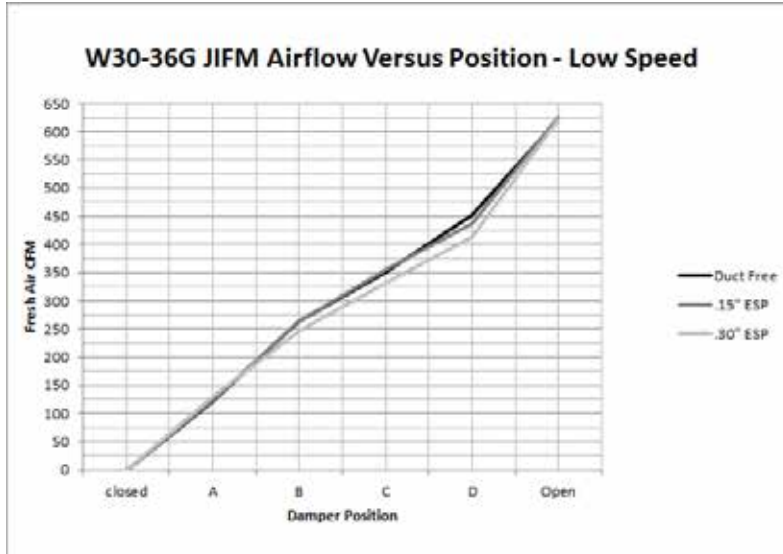




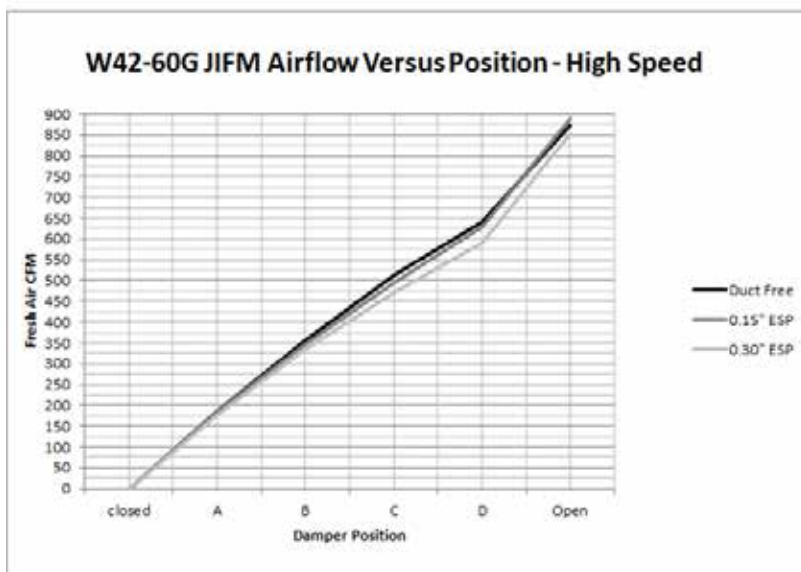
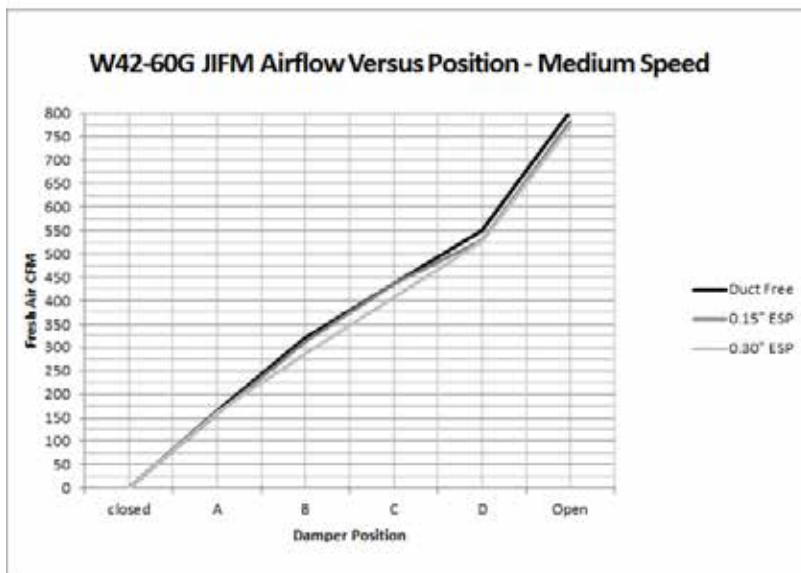
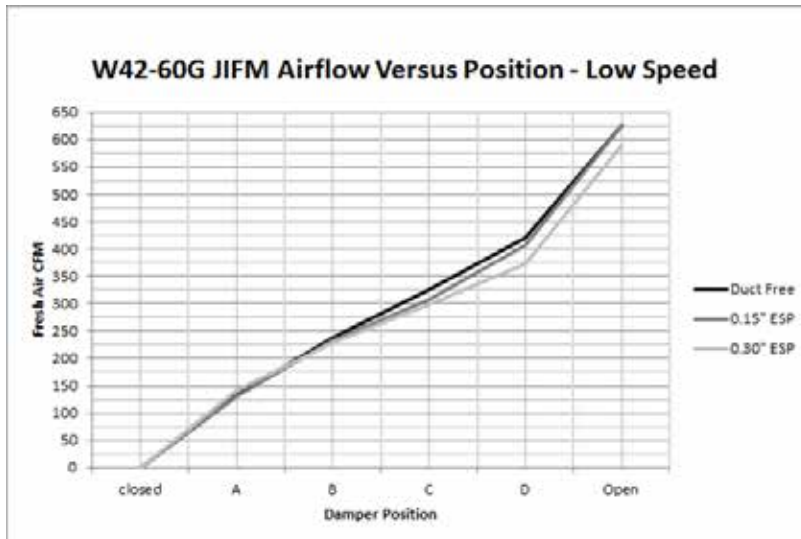
**GRAPH 4**  
**W24G JIFM Ventilation Airflow**



**GRAPH 5**  
**W30G-W36G JIFM Ventilation Airflow**



**GRAPH 6**  
**W42G-W60G JIFM Ventilation Airflow**



## ECONOMIZER SEQUENCE OF OPERATION

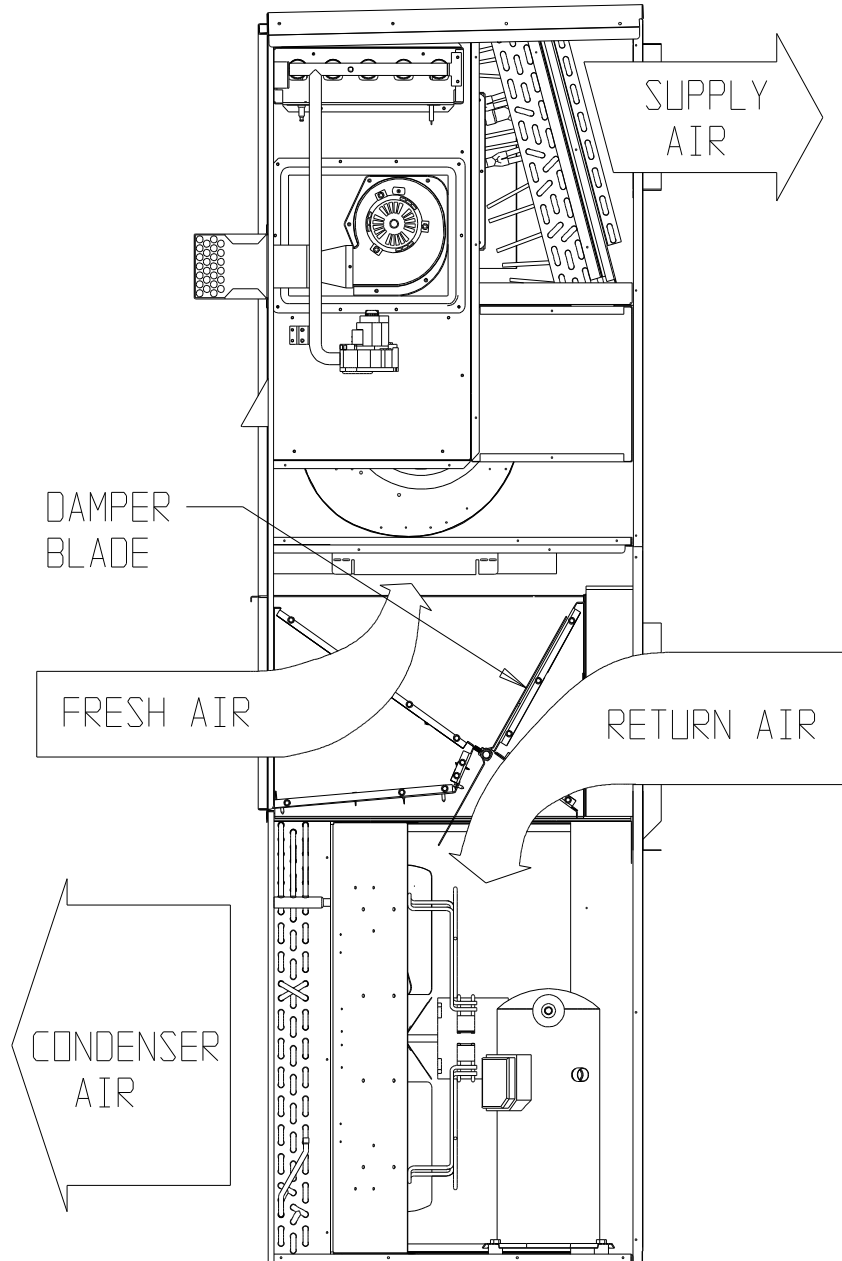
### CONDITION A – COOL OUTDOORS

First stage cooling closes and powers the economizer dampers to economizer mode and the indoor blower starts. Mixed air sensor senses a mixture of return air and outdoor air and modulates the dampers

accordingly. Compressor operation is inhibited. (See Figure 7.)

If second stage closes on the thermostat, the compressor starts for mechanical cooling.

**FIGURE 7**  
**Call for Blower Operation**

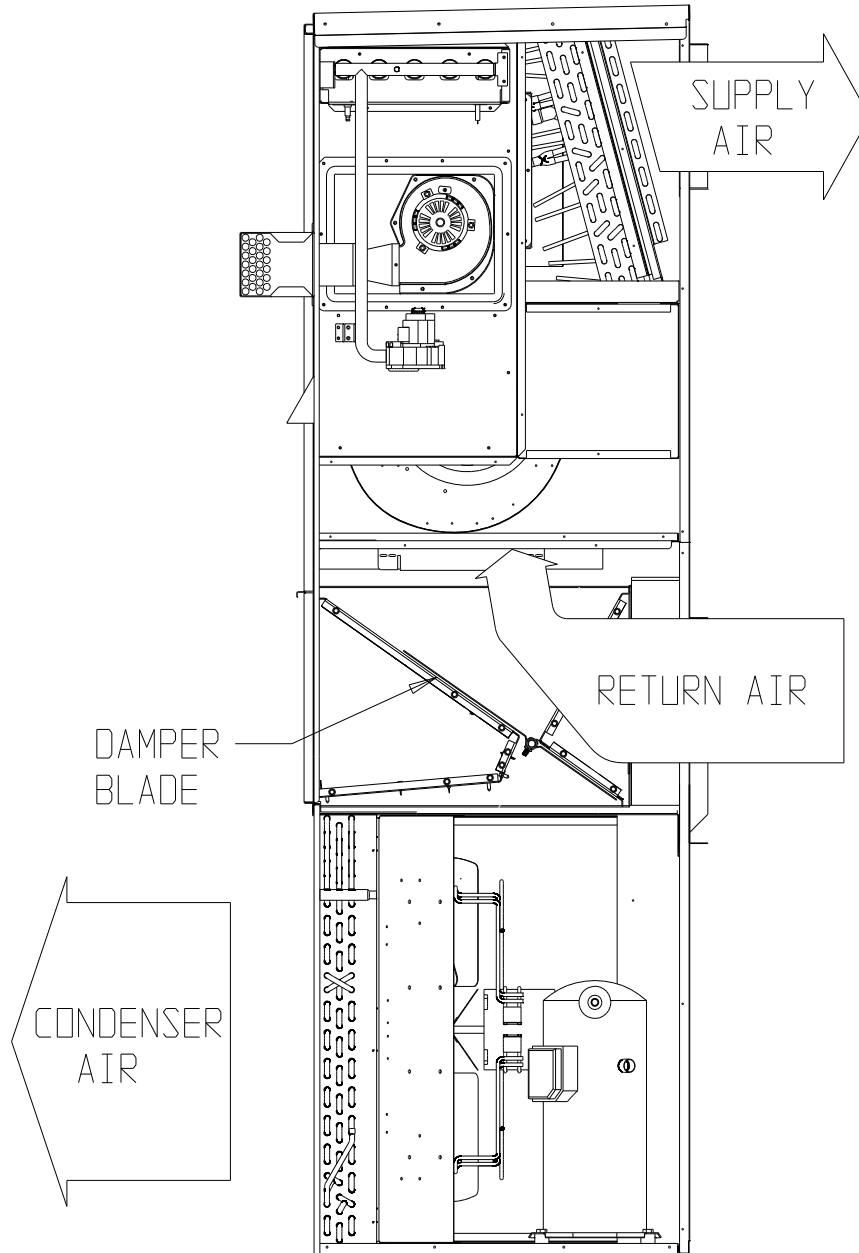


MIS-2413

**CONDITION B – WARM OUTDOORS**

First stage cooling cycles the compressor and dampers remain in minimum position.

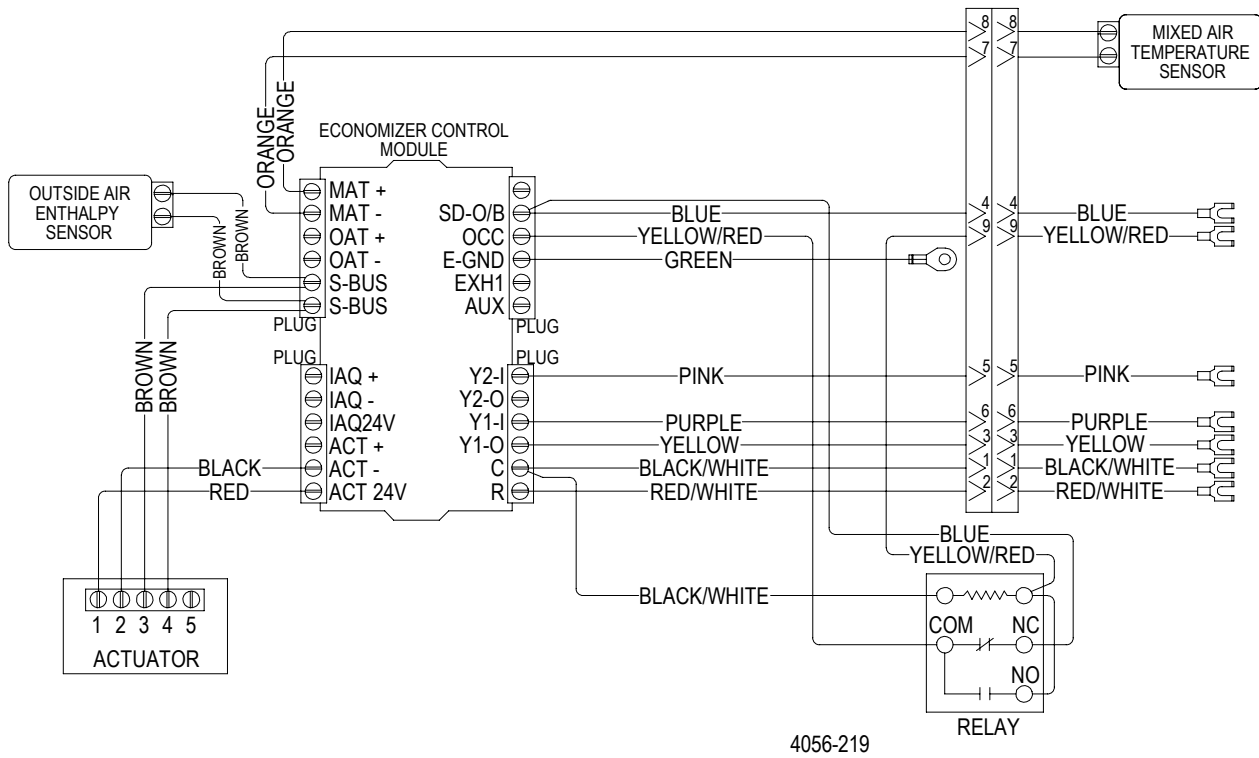
**FIGURE 8**  
**Call for Cooling Operation**



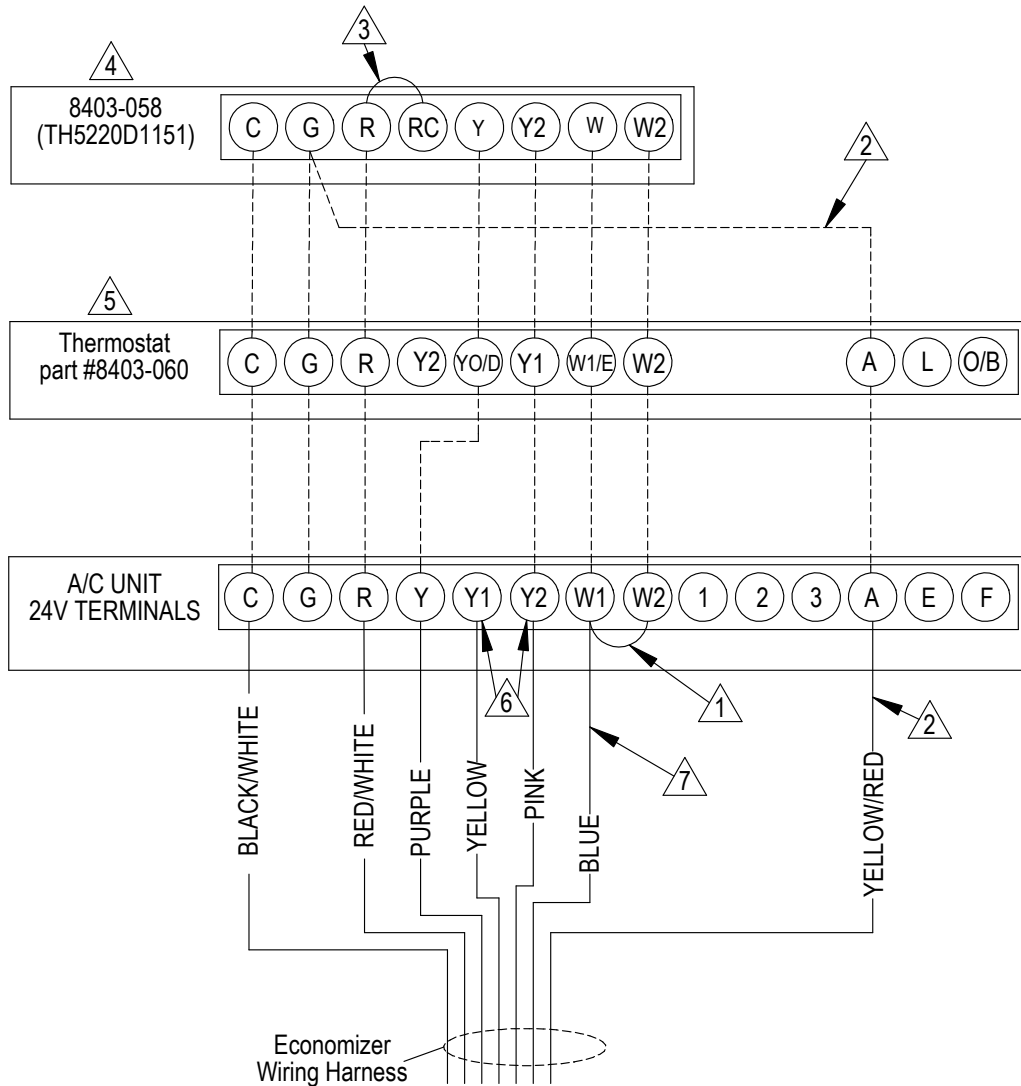
MIS-2412 A

**FIGURE 9**  
**Wiring Diagram (All Models)**

*Economizer Wiring Diagram*



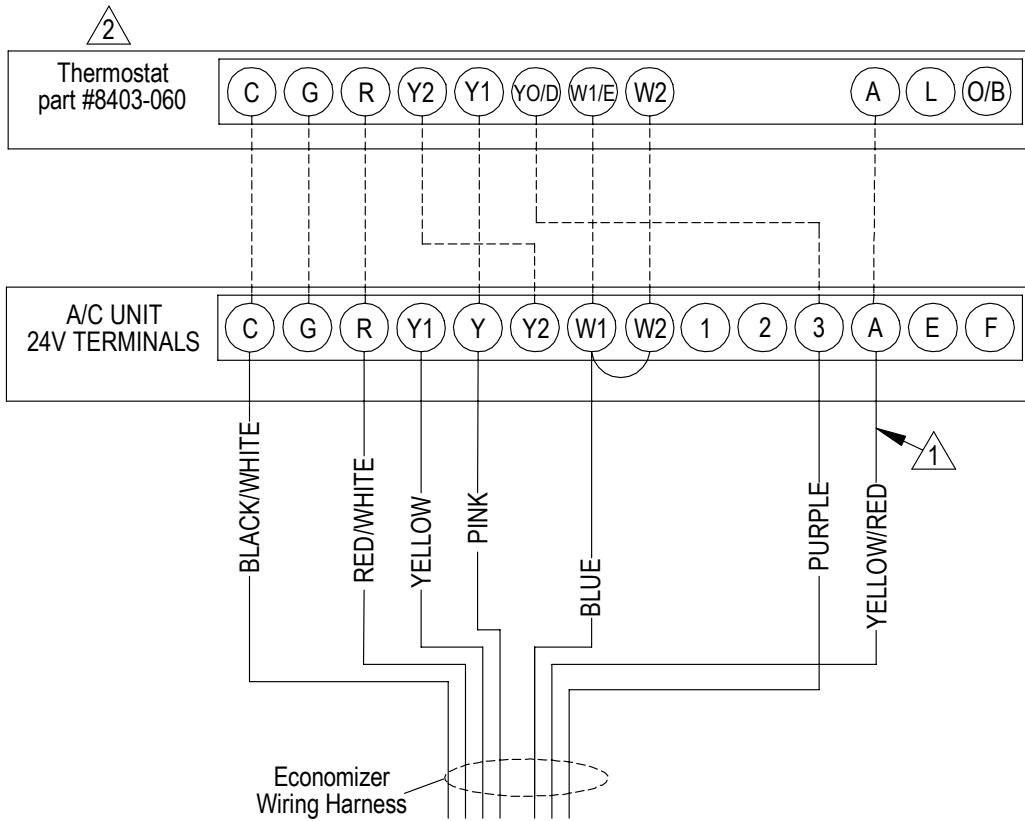
**FIGURE 10**  
**Low Voltage Wiring Diagram**  
**1-Stage A/C with Gas Heat with WGJIFM-✱ Style Economizer**



- ① Factory installed jumper.
- ② Must be energized to enable minimum position. NOTE: Economizer Control Default Setting is 10V (100%). Depending upon application may require setting to lower value.
- ③ Factory installed jumper.
- ④ Change "system type", set up function 1, from 5 (2 heat/ 1 cool heat pump) to 6 (2 heat/ 2 cool conventional).
- ⑤ Change model configuration from heat pump to heat/cool, and must be configured for economizer for YO/D output to be active as first stage cooling.
- ⑥ Older units may not have Y1 and Y2 connections on 24v terminal block. If not present wire nuts must be used.
- ⑦ For demand ventilation and/or to disable ventilation on call for heat, move blue wire to "A" terminal.

MIS-3349 A

**FIGURE 11**  
**Low Voltage Wiring Diagram**  
**2-Stage A/C with Gas Heat with WGSJIFM\*5 Style Economizer**

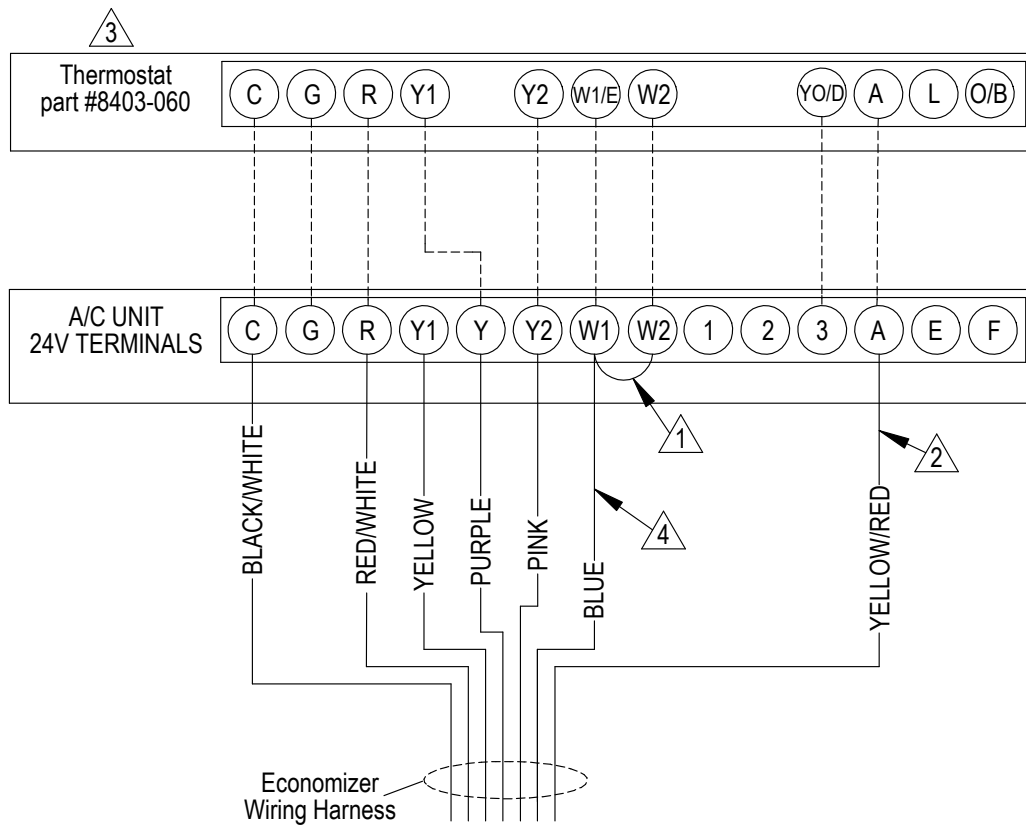


- 1 Must be energized to enable minimum position. NOTE: Economizer Control Default Setting is 10V (100%). Depending upon application may require setting to lower value. If using this feature, move blue wire from "W1" to "A" terminal.
- 2 Change model configuration from heat pump to heat/cool, and must be configured for economizer for YO/D output to be active as first stage cooling.

MIS-3350 C



**FIGURE 12**  
**Low Voltage Wiring Diagram**  
**1-Stage A/C with Dehumidification Gas Heat with WGJFM-\* Style Economizer**



- ⚠️ 1 Factory installed jumper.
- ⚠️ 2 Must be energized to enable minimum position. NOTE: Economizer Control Default Setting is 10V (100%). Depending upon application may require setting to lower value.
- ⚠️ 3 Change model configuration from heat pump to heat/cool. Do not configure for economizer.
- ⚠️ 4 For demand ventilation and/or to disable ventilation on a call for heat, move blue wire to "A" terminal.

MIS-3351 B