INSTALLATION INSTRUCTIONS

WALL MOUNTED PACKAGED AIR CONDITIONER

Models:

W18AA-A	W36AA-B	W48AA-C	W18LA-A	W42LA-C	W30AADA
W24AA-A	W36AA-C	W48AA-E	W24LA-A	W42LA-F	W30AADB
W24AA-B	W36AA-D	W48AA-F	W24LA-B	W48LA-A	W30AADC
W24AA-C	W36AA-E	W60AA-A	W24LA-F	W48LA-B	W36AADA
W24AA-D	W36AA-F	W60AA-B	W30LA-A	W48LA-C	W36AADB
W24AA-F	W42AA-A	W60AA-C	W30LA-B	W48LA-F	W36AADC
W30AA-A	W42AA-B	W60AA-E	W30LA-C	W60LA-A	W42AADA
W30AA-B	W42AA-C	W60AA-F	W30LA-F	W60LA-B	W42AADB
W30AA-C	W42AA-E	W72AA-A	W36LA-A	W60LA-C	W42AADC
W30AA-D	W42AA-F	W72AA-B	W36LA-B	W60LA-F	W48AADA
W30AA-F	W48AA-A	W72AA-C	W36LA-C	W72LA-A	W48AADB
W36AA-A	W48AA-B	W72AA-F	W36LA-F	W72LA-B	W48AADC
			W42LA-A	W72LA-C	W60AADA
			W42LA-B	W72LA-F	W60AADB
					W60AADC



Bard Manufacturing Company, Inc.
Bryan, Ohio 43506
www.bardhvac.com

Manual: 2100-640C
Supersedes: 2100-640B
Date: 7-26-17

CONTENTS

Getting Other Information and Publications 3

Wall Mount General Information 4

Air Conditioner Wall Mount Model Nomenclature	4
Shipping Damage	4
General	4
Duct Work	5
Filters	5
Fresh Air Intake	5
Condensate Drain	5

Installation 6

Wall Mounting Information	6
Mounting the Unit	6
Clearances Required	6
Minimum Clearances	6
Wiring – Main Power	15
Wiring – Low Voltage Wiring	15

Figures

Figure 1 Fresh Air Damper	5
Figure 2 Unit Dimensions	7
Figure 3A Mounting Instructions – W18, 24	8
Figure 3B Mounting Instructions – W30, 36	9
Figure 3C Mounting Instructions – W42, 48	10
Figure 3D Mounting Instructions – W60, 72	11
Figure 4 Electric Heat Clearance	12
Figure 5 Wall Mounting Instructions	13
Figure 6 Wall Mounting Instructions	13
Figure 7 Common Wall Mounting Installations	14
Figure 8 Programmable Thermostat Connections	17
Figure 9 Non-Programmable Thermostat Connections	18
Figure 10 Motor Connections	22
Figure 11 Motor Connections	23
Figure 12 Fan Blade Setting	24

Start Up 19

General	19
Topping Off System Charge	19
Safety Practices	19
Important Installer Note	19
High Pressure Switch	20
Three Phase Scroll Compressor	20
Phase Monitor	20
Condenser Fan Operation	20
Service Hints	20
Sequence of Operation	20
Vent Connection Plug	20
Compressor Control Module	21
Pressure Service Ports	21

Service 22

Troubleshooting Nidec SelecTech Series ECM Motors	22
Fan Blade Setting Dimensions	24
R-410A Refrigerant Charge	24
Removal of Fan Shroud	24

Tables

Table 1 Wall Thermostats	16
Table 2 Humidity Controls	16
Table 3 CO2 Controller	16
Table 4 Thermostat Wire Size	16
Table 5 Fan Blade Dimensions	24
Table 6 Cooling Pressure	25
Table 7 Electrical Specifications W**A	26
Table 8 Electrical Specifications W**L	27
Table 9 Recommended Airflow	28
Table 10 Indoor Blower Performance	28
Table 11 Maximum ESP Electric Heat Only	28
Table 12 Electric Heat	29
Table 13 Vent and Control Options	30
Table 14A Optional Accessories – Right Hand	31
Table 14B Optional Accessories – Left Hand	32

GETTING OTHER INFORMATION AND PUBLICATIONS

These publications can help when installing the furnace. They can usually be found at the local library or purchased directly from the publisher. Be sure to consult the current edition of each standard.

National Electrical Code.....ANSI/NFPA 70

Standard for the InstallationANSI/NFPA 90A
of Air Conditioning and Ventilating Systems

Standard for Warm Air.....ANSI/NFPA 90B
Heating and Air Conditioning Systems

Load Calculation for ACCA Manual J
Residential Winter and Summer Air Conditioning

Duct Design for Residential ACCA Manual D
Winter and Summer Air Conditioning and Equipment
Selection

For more information, contact these publishers:

ACCA **Air Conditioning Contractors of America**
1712 New Hampshire Ave. N.W.
Washington, DC 20009
Telephone: (202) 483-9370
Fax: (202) 234-4721

ANSI **American National Standards Institute**
11 West Street, 13th Floor
New York, NY 10036
Telephone: (212) 642-4900
Fax: (212) 302-1286

ASHRAE **American Society of Heating, Refrigeration
and Air Conditioning Engineers, Inc.**
1791 Tullie Circle, N.E.
Atlanta, GA 30329-2305
Telephone: (404) 636-8400
Fax: (404) 321-5478

NFPA **National Fire Protection Association**
Batterymarch Park
P.O. Box 9101
Quincy, MA 02269-9901
Telephone: (800) 344-3555
Fax: (617) 984-7057

WALL MOUNT GENERAL INFORMATION

AIR CONDITIONER WALL MOUNT MODEL NOMENCLATURE

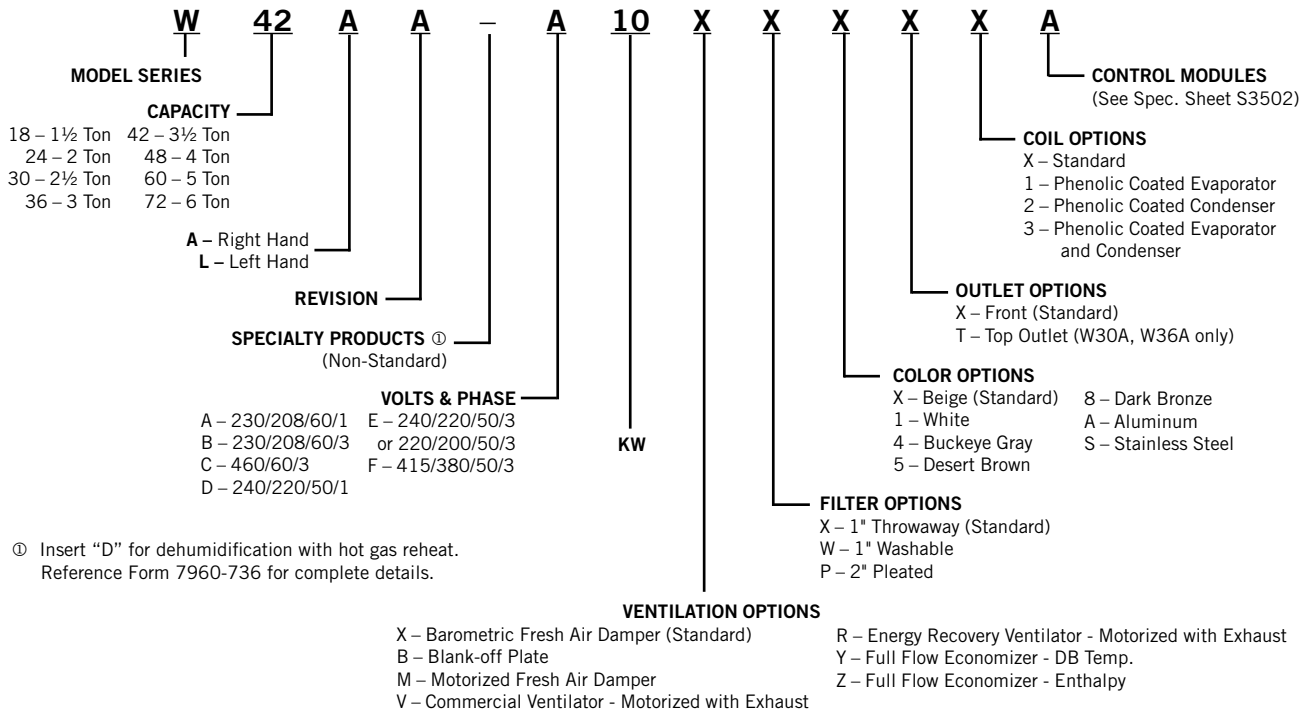

NOTE: Vent options X, B and M are without exhaust capability. May require separate field-supplied barometric relief in building.

SHIPPING DAMAGE

Upon receipt of equipment, the carton should be checked for external signs of shipping damage. If damage is found, the receiving party must contact the last carrier immediately, preferably in writing, requesting inspection by the carrier's agent.

GENERAL

The equipment covered in this manual is to be installed by trained, experienced service and installation technicians.

This appliance is not intended for use by persons (including children) with reduced physical, sensory or mental capabilities, or lack of experience and knowledge, unless they have been given supervision or instruction concerning use of the appliance by a person responsible for their safety.

Children should be supervised to ensure that they do not play with the appliance.

The refrigerant system is completely assembled and charged. All internal wiring is complete.

The unit is designed for use with or without duct work. Flanges are provided for attaching the supply and return ducts.

These instructions explain the recommended method to install the air cooled self-contained unit and the electrical wiring connections to the unit.

These instructions and any instructions packaged with any separate equipment required to make up the entire air conditioning system should be carefully read before beginning the installation. Note particularly "Starting Procedure" and any tags and/or labels attached to the equipment.

While these instructions are intended as a general recommended guide, they do not supersede any national and/or local codes in any way. Authorities having jurisdiction should be consulted before the installation is made. See page 3 for information on codes and standards.

Size of unit for a proposed installation should be based on heat loss calculation made according to methods of Air Conditioning Contractors of America (ACCA). The air duct should be installed in accordance with the Standards of the National Fire Protection Association for the Installation of Air Conditioning and Ventilating Systems of Other Than Residence Type, NFPA No. 90A, and Residence Type Warm Air Heating and Air Conditioning Systems, NFPA No. 90B. Where local regulations are at a variance with instructions, installer should adhere to local codes.

DUCT WORK

All duct work, supply and return, must be properly sized for the design airflow requirement of the equipment. Air Conditioning Contractors of America (ACCA) is an excellent guide to proper sizing. All duct work or portions thereof not in the conditioned space should be properly insulated in order to both conserve energy and prevent condensation or moisture damage.

Refer to Maximum ESP of operation Electric Heat Table 11 on page 28.

Design the duct work according to methods given by the Air Conditioning Contractors of America (ACCA). When duct runs through unheated spaces, it should be insulated with a minimum of one inch of insulation. Use insulation with a vapor barrier on the outside of the insulation. Flexible joints should be used to connect the duct work to the equipment in order to keep the noise transmission to a minimum.

Models W18 – W24 are approved for 0" clearance to the supply duct. For model series W30, W36, W42, W48, W60 and W72, a 1/4" clearance to combustible material for the first 3' of duct attached to the outlet air frame is required. See wall mounting instructions on page 6 and Figures 3 and 4 (pages 8 – 12) for further details.

Ducts through the walls must be insulated and all joints taped or sealed to prevent air or moisture entering the wall cavity.

Some installations may not require any return air duct. A metallic return air grille is required with installations not requiring a return air duct. The spacing between louvers on the grille shall not be larger than 5/8".

Any grille that meets with 5/8" louver criteria may be used. It is recommended that Bard Return Air Grille Kit RG2 through RG5 or RFG2 through RFG5 be installed when no return duct is used. Contact distributor or factory for ordering information. If using a return air filter grille, filters must be of sufficient size to allow a maximum velocity of 400 fpm.

NOTE: *If no return air duct is used, applicable installation codes may limit this cabinet to installation only in a single story structure.*

FILTERS

A 1" throwaway filter is standard with each unit. The filter slides into position making it easy to service. This filter can be serviced from the outside by removing the filter access panel. A 1" washable filter and 2" pleated filter are also available as optional accessories. The internal filter brackets are adjustable to accommodate the 2" filter by bending two tabs down on each side of the filter support bracket.

FRESH AIR INTAKE

All units are built with fresh air inlet slots punched in the service door.

If the unit is equipped with a fresh air damper assembly, the assembly is shipped already attached to the unit. The damper blade is locked in the closed position. To allow the damper to operate, the maximum and minimum blade position stops must be installed (see Figure 1).

All capacity, efficiency and cost of operation information is based upon the fresh air blank-off plate in place and is recommended for maximum energy efficiency.

The blank-off plate is available upon request from the factory and is installed in place of the fresh air damper shipped with each unit.

CONDENSATE DRAIN

A plastic drain hose extends from the drain pan at the top of the unit down to the unit base. There are openings in the unit base for the drain hose to pass through. In the event the drain hose is connected to a drain system of some type, it must be an open or vented type system to assure proper drainage.

FIGURE 1
Fresh Air Damper

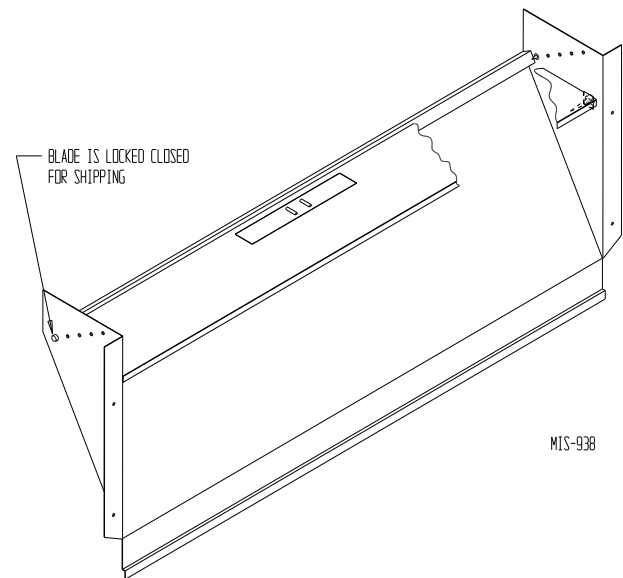

INSTALLATION

WALL MOUNTING INFORMATION

1. Two holes for the supply and return air openings must be cut through the wall as shown in Figures 3A – D (pages 8 – 11).
2. On wood frame walls, the wall construction must be strong and rigid enough to carry the weight of the unit without transmitting any unit vibration.
3. Concrete block and brick walls must be thoroughly inspected to insure that they are capable of carrying the weight of the installed unit.

MOUNTING THE UNIT

1. These units are secured by wall mounting brackets which secure the unit to the outside wall surface at both sides. A bottom mounting bracket, attached to skid for shipping, is provided for ease of installation, but is not required.
2. The supply air duct flange and the first 3' of supply air duct require a minimum of 1/4" clearance to combustible material for model series W30, W36, W42, W48, W60 and W72. However, it is generally recommended that a 1" clearance is used for ease of installation and maintaining the required clearance to combustible material. See Figures 3A – D for details on opening sizes.
3. Locate and mark lag bolt locations and bottom mounting bracket location (see Figures 3A – D).
4. Mount bottom mounting bracket.
5. Hook top rain flashing, attached to front-right of supply flange for shipping, under back bend of top.

WARNING

Failure to provide the 1/4" clearance between the supply duct and a combustible surface for the first 3' of duct can result in fire causing damage, injury or death.

6. Position unit in opening and secure with 5/16 lag bolts; use 7/8" diameter flat washers on the lag bolts.
7. Secure rain flashing to wall and caulk across entire length of top (see Figures 3A – D).
8. For additional mounting rigidity, the return air and supply air frames or collars can be drilled and screwed or welded to the structural wall itself (depending upon wall construction). Be sure to observe required clearance if combustible wall.
9. On side-by-side installations, maintain a minimum of 20" clearance on right side to allow access to control panel and heat strips and proper airflow to the outdoor coil. Additional clearance may be required to meet local or national codes.

Clearances Required for Service Access and Adequate Condenser Airflow

MODELS	LEFT SIDE	RIGHT SIDE	DISCHARGE SIDE
W18A, W24A, W30A, W36A	15"	20"	10'
W18L, W24L, W30L, W36L	20"	15"	10'
W42A, W48A, W60A, W72A	20"	20"	10'
W42L, W48L, W60L, W72L	20"	20"	10'

NOTE: For side-by-side installation of two W**A models there must be 20" between units. This can be reduced to 15" by using a W**L model (left side compressor and controls) for the left unit and W**A (right side compressor and controls) for right unit.

See Specifications Sheet S3502.

Minimum Clearances Required to Combustible Materials

MODELS	SUPPLY AIR DUCT FIRST 3'	CABINET
W18A, L W24A, L	0"	0"
W30A, L W36A, L	1/4"	0"
W42A, L W48A, L W60A, L W72A, L	1/4"	0"

FIGURE 2

Dimensions of Basic Unit for Architectural and Installation Requirements (Nominal)

MODEL	WIDTH (W)	DEPTH (D)	HEIGHT (H)	SUPPLY		RETURN																
				A	B	C	B	E	F	G	I	J	K	L	M	N	O	P	Q	R	S	T
W18AA W24AA	33.300	17.125	74.563	7.88	19.88	11.88	19.88	35.00	10.88	29.75	20.56	30.75	32.06	33.25	31.00	2.63	34.13	26.06	10.55	4.19	12.00	9.00
W30AA W36AA	38.200	17.125	74.563	7.88	27.88	13.88	27.88	40.00	10.88	29.75	17.93	30.75	32.75	33.25	31.00	2.75	39.13	26.75	9.14	4.19	12.00	9.00
W42AA W48AA	42.075	22.432	84.875	9.88	29.88	15.88	29.88	43.88	13.56	31.66	30.00	32.68	26.94	34.69	32.43	3.37	43.00	23.88	10.00	1.44	16.00	1.88
W60AA W72AA	42.075	22.432	93.000	9.88	29.88	15.88	29.88	43.88	13.56	37.00	30.00	40.81	35.06	42.81	40.56	3.37	43.00	31.00	10.00	1.44	16.00	10.00

All dimensions are in inches. Dimensional drawings are not to scale.

WA
RIGHT
UNIT**

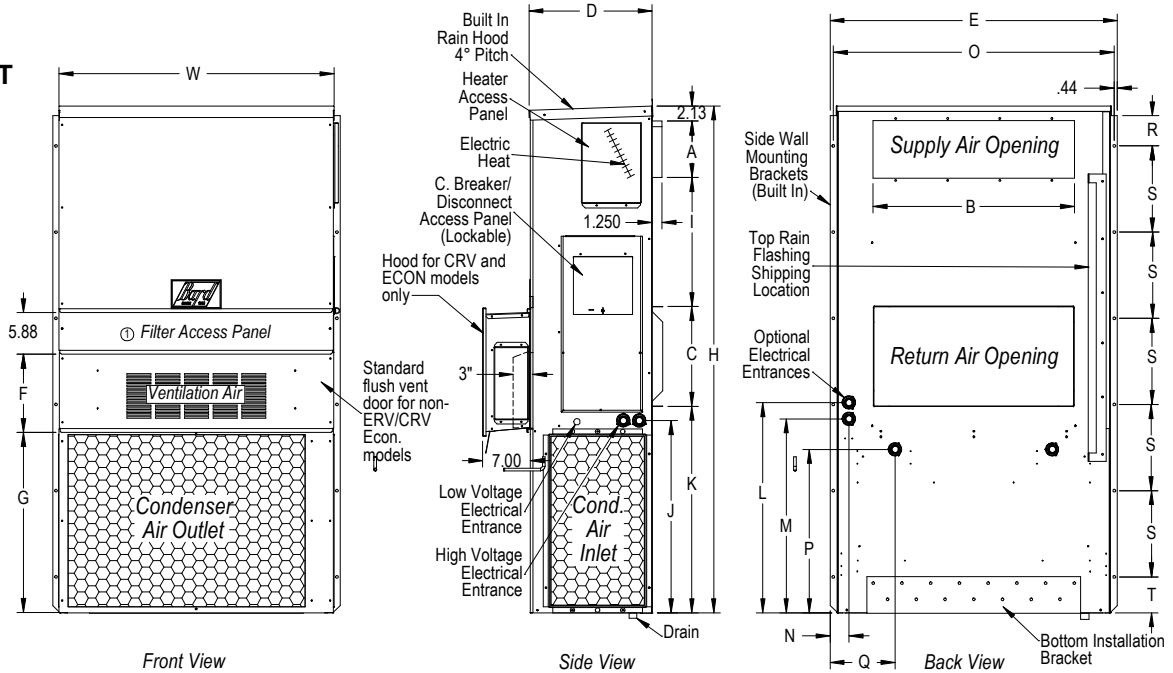

MIS-3736

WL
LEFT
UNIT**

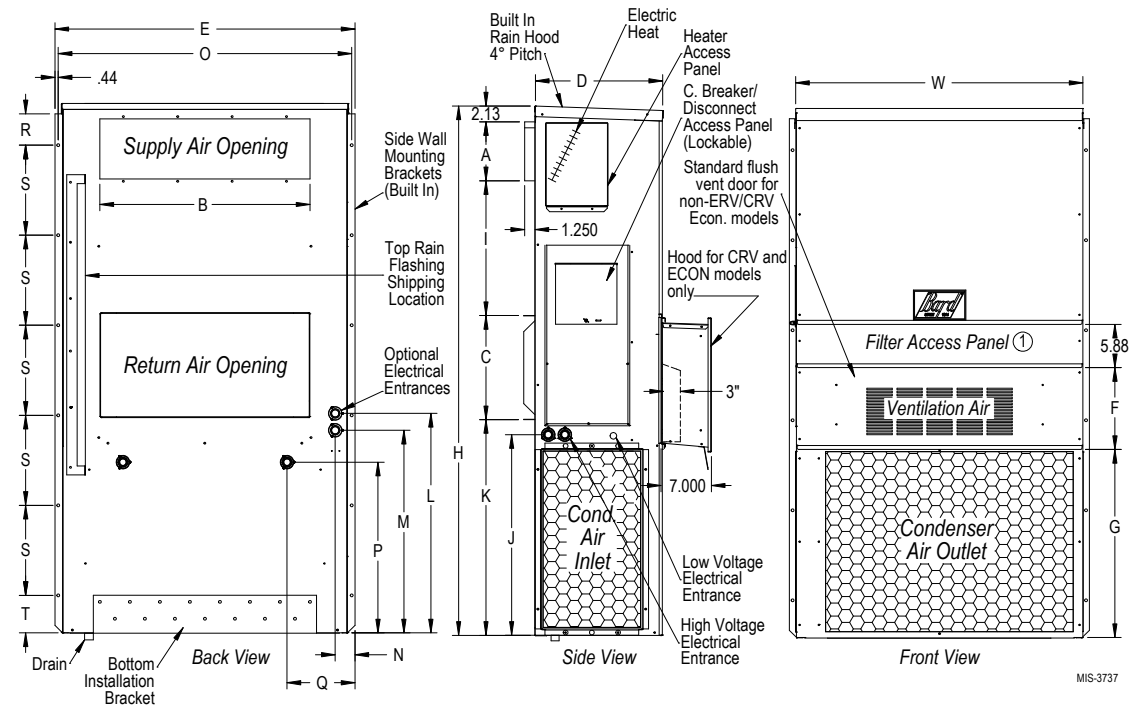

MIS-3737

FIGURE 3A
W18A, W18L, W24A, W24L
Mounting Instructions

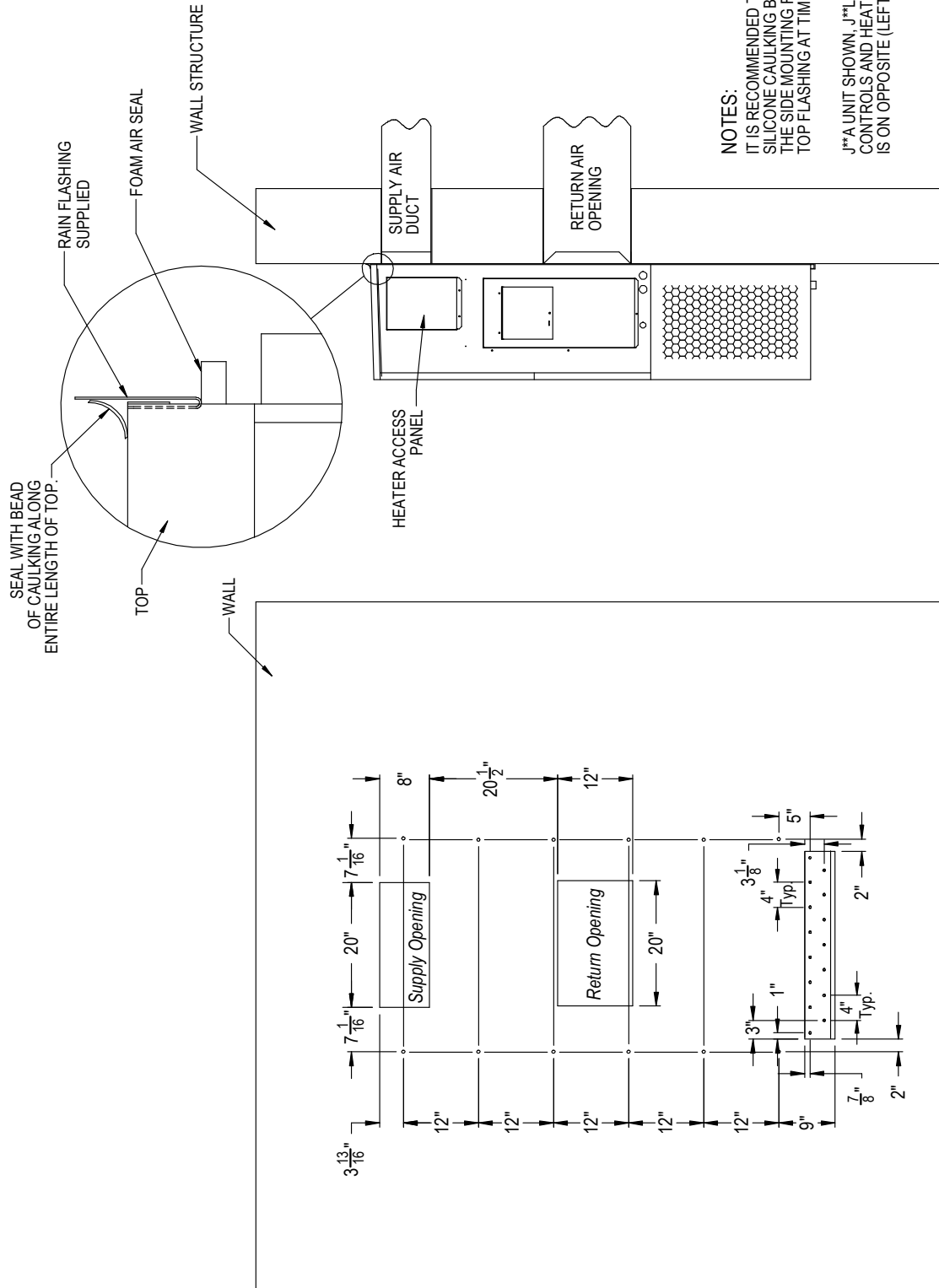

MIS-3157 A

FIGURE 3B
W30A, W30L, W36A, W36L
Mounting Instructions

	A	B	C	D	E
REQUIRED DIMENSIONS TO MAINTAIN 1/4" MIN. CLEARANCE FROM COMBUSTIBLE MATERIALS	28 3/8	8 3/8	5 3/8	3 11/16	17 5/8
REQUIRED DIMENSIONS TO MAINTAIN RECOMMENDED 1" CLEARANCE FROM COMBUSTIBLE MATERIALS	29 7/8	9 7/8	4 5/8	4 7/16	16 7/8

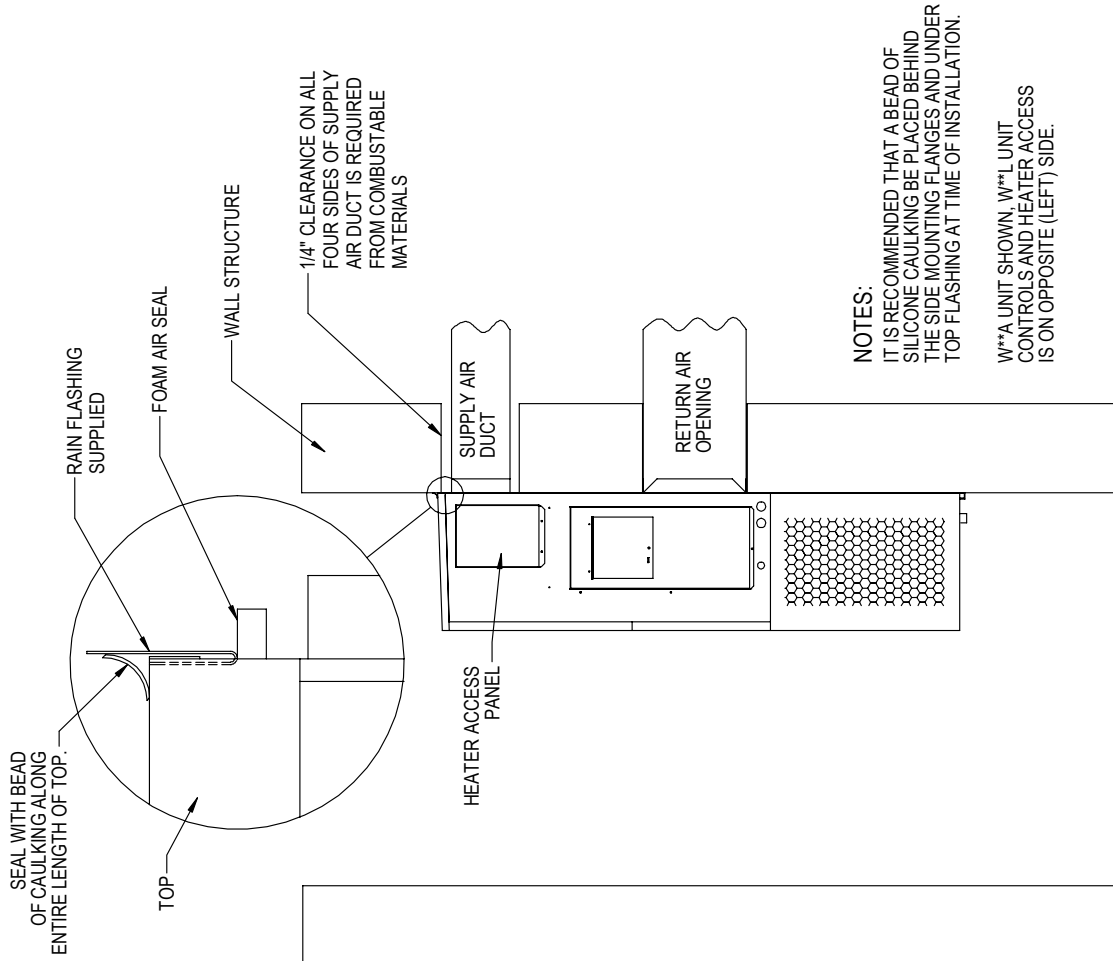

NOTES:
 IT IS RECOMMENDED THAT A BEAD OF SILICONE CAULKING BE PLACED BEHIND THE SIDE MOUNTING FLANGES AND UNDER TOP FLASHING AT TIME OF INSTALLATION.
 W**A UNIT SHOWN, W**L UNIT CONTROLS AND HEATER ACCESS IS ON OPPOSITE (LEFT) SIDE.

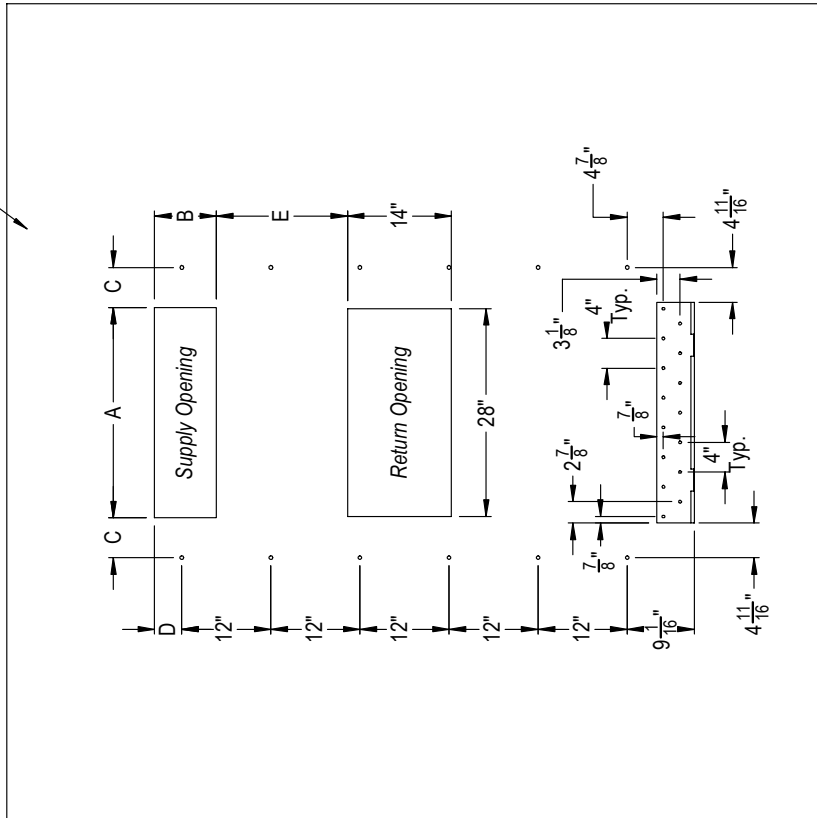

Right Side View

Wall Opening and Hole Location View

FIGURE 3C
W42A, W42L, W48A, W48L
Mounting Instructions

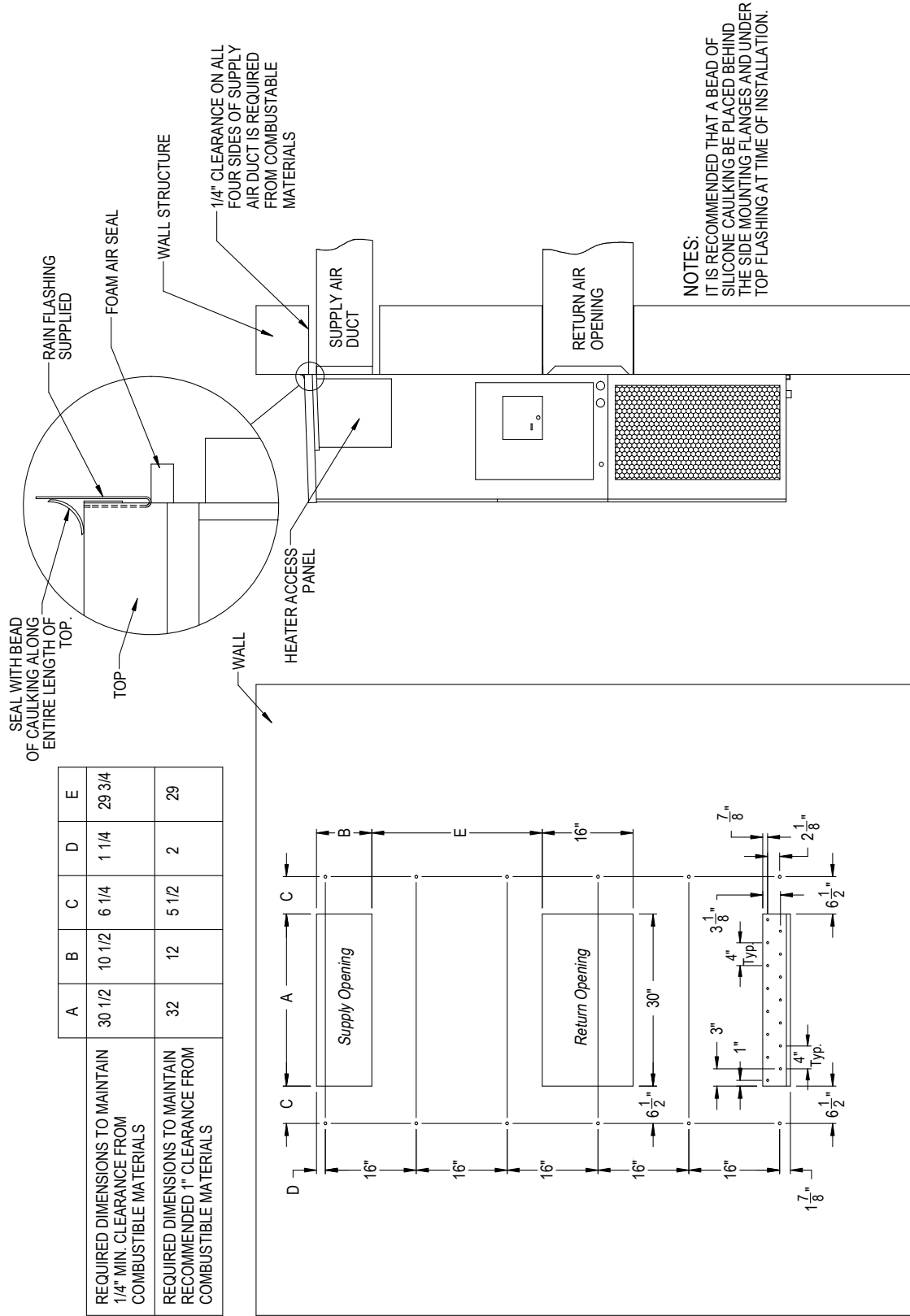

	A	B	C	D	E
REQUIRED DIMENSIONS TO MAINTAIN 1/4" MIN. CLEARANCE FROM COMBUSTIBLE MATERIALS	30 1/2	10 1/2	6 1/4	1 1/4	29 3/4
REQUIRED DIMENSIONS TO MAINTAIN RECOMMENDED 1" CLEARANCE FROM COMBUSTIBLE MATERIALS	32	12	5 1/2	2	29

NOTES:
 IT IS RECOMMENDED THAT A BEAD OF SILICONE CAULKING BE PLACED BEHIND THE SIDE MOUNTING FLANGES AND UNDER TOP FLASHING AT TIME OF INSTALLATION.

MIS-416 E

FIGURE 3D
W60A, W60L, W72A, W72L
Mounting Instructions

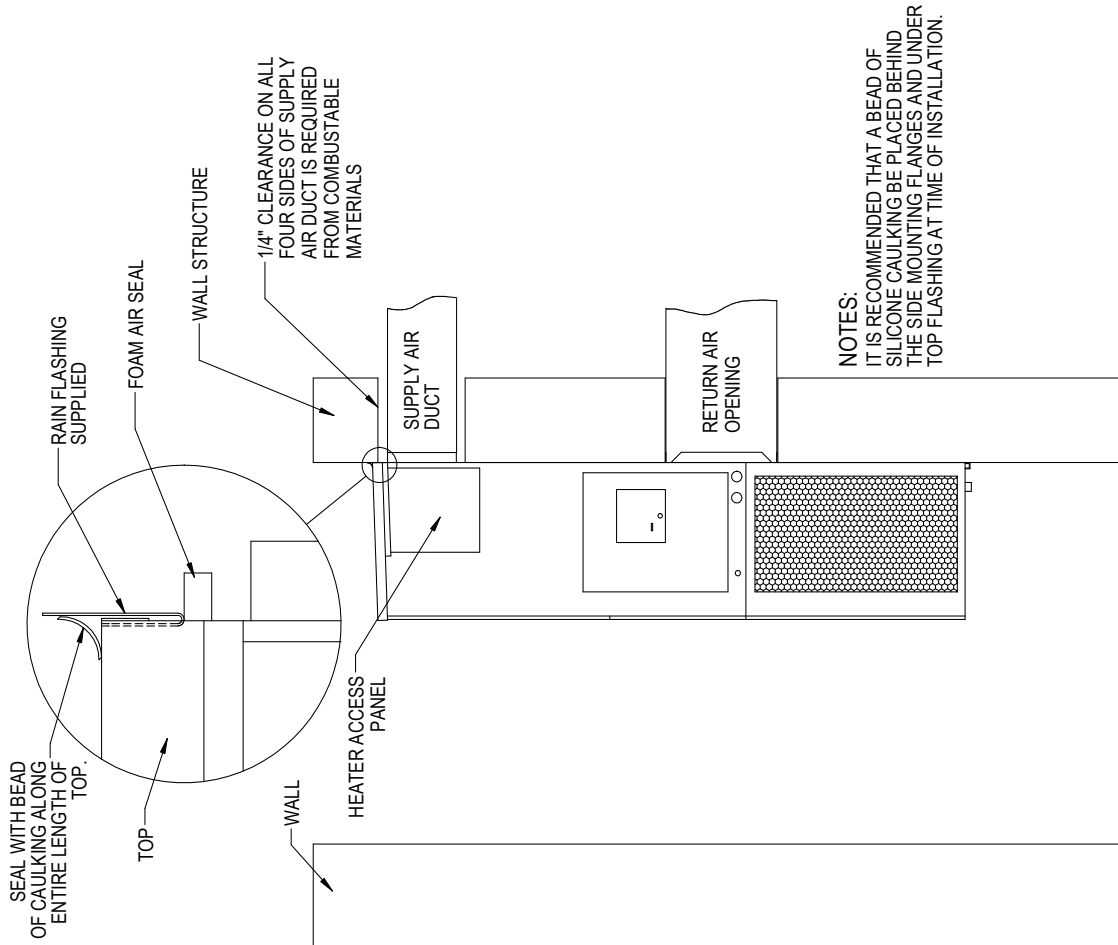

NOTES:
 IT IS RECOMMENDED THAT A BEAD OF SILICONE CAULKING BE PLACED BEHIND THE SIDE MOUNTING FLANGES AND UNDER TOP FLASHING AT TIME OF INSTALLATION.

Right Side View

	A	B	C	D	E
REQUIRED DIMENSIONS TO MAINTAIN 1/4" MIN. CLEARANCE FROM COMBUSTIBLE MATERIALS	30 1/2	10 1/2	6 1/4	1 1/4	29 3/4
REQUIRED DIMENSIONS TO MAINTAIN RECOMMENDED 1" CLEARANCE FROM COMBUSTIBLE MATERIALS	32	12	5 1/2	2	29

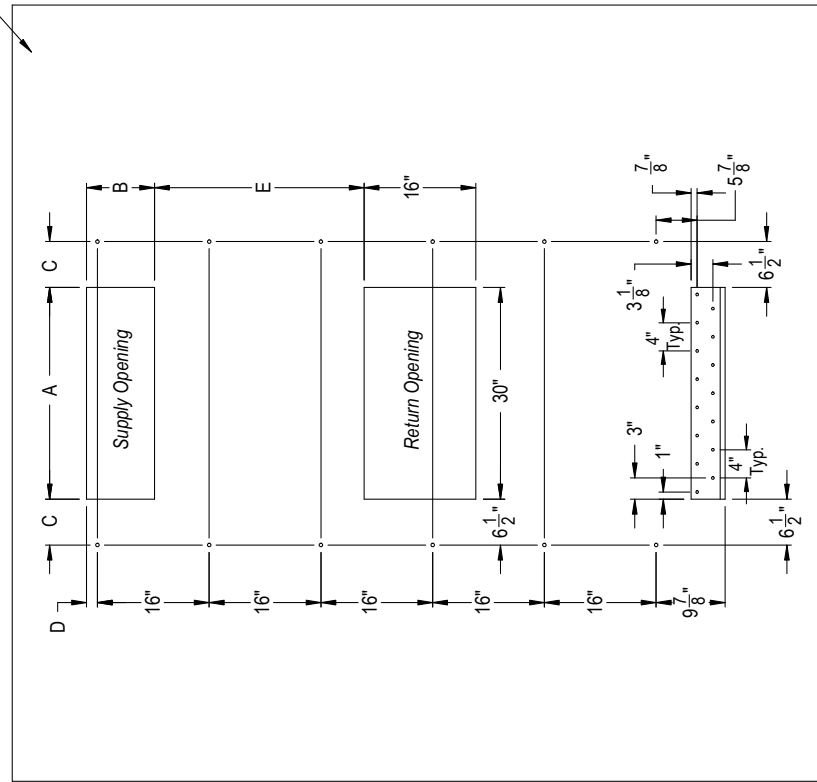

Wall Opening and Hole Location View

FIGURE 4
Electric Heat Clearance
W30A, W30L, W36A, W36L, W42A, W42L, W48A, W48L, W60A, W60L, W72A, W72L

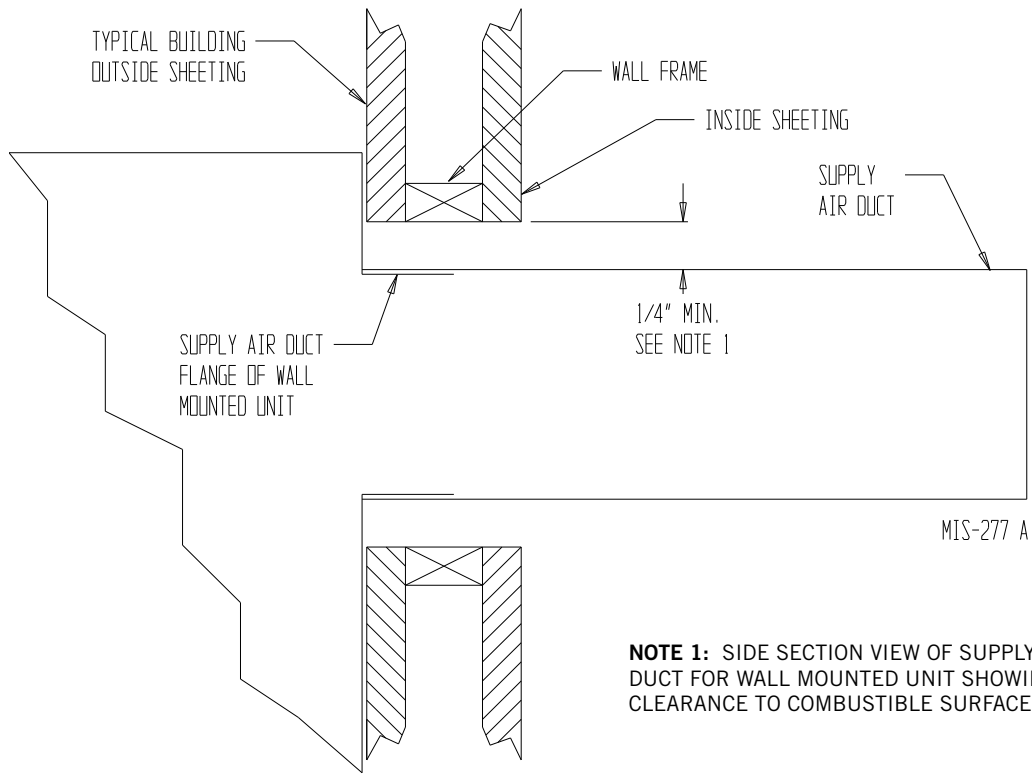

 <h1 style="margin: 0;">WARNING</h1>
<p>A <i>minimum</i> of 1/4" clearance must be maintained between the supply air duct and combustible materials. This is required for the first 3' of ducting.</p> <p>It is important to insure that the 1/4" minimum spacing is maintained at all points.</p> <p>Failure to do this could result in overheating the combustible material and may result in a fire causing damage, injury or death.</p>

FIGURE 5
Wall Mounting Instructions

SEE FIGURES 3A THROUGH 3D – MOUNTING INSTRUCTIONS



CONCRETE BLOCK WALL INSTALLATION

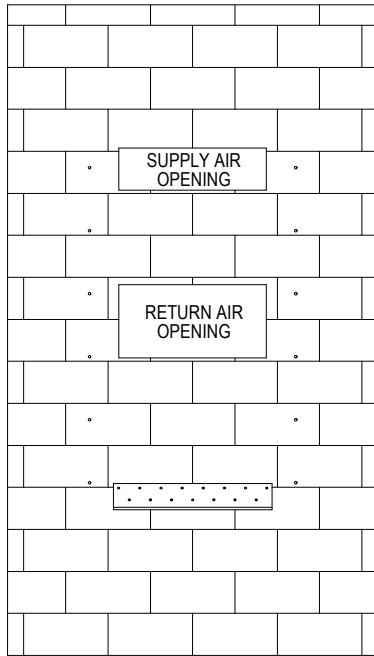
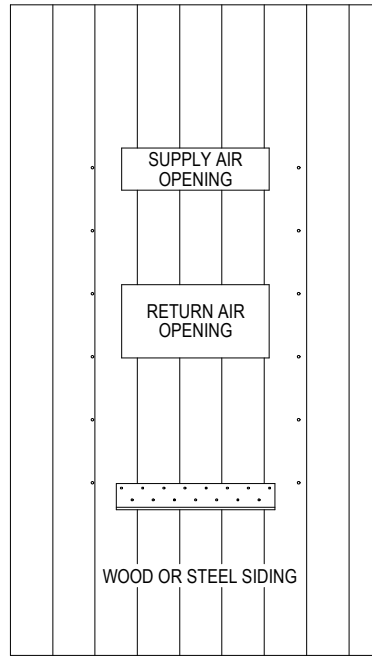

WOOD FRAME WALL INSTALLATION

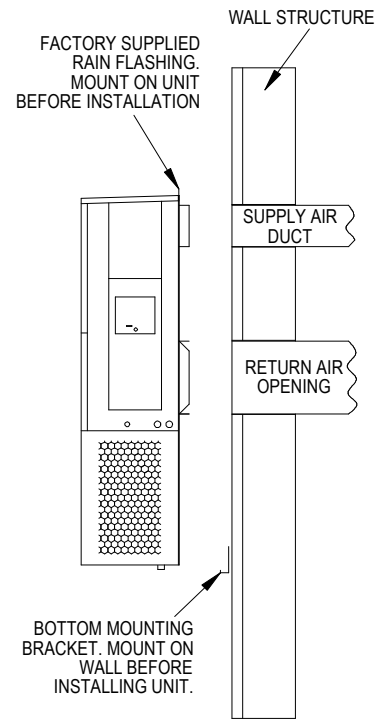

SIDE VIEW

MIS-548 A

FIGURE 6
Wall Mounting Instructions

SEE UNIT DIMENSIONS, FIGURE 2,
FOR ACTUAL DIMENSIONS.

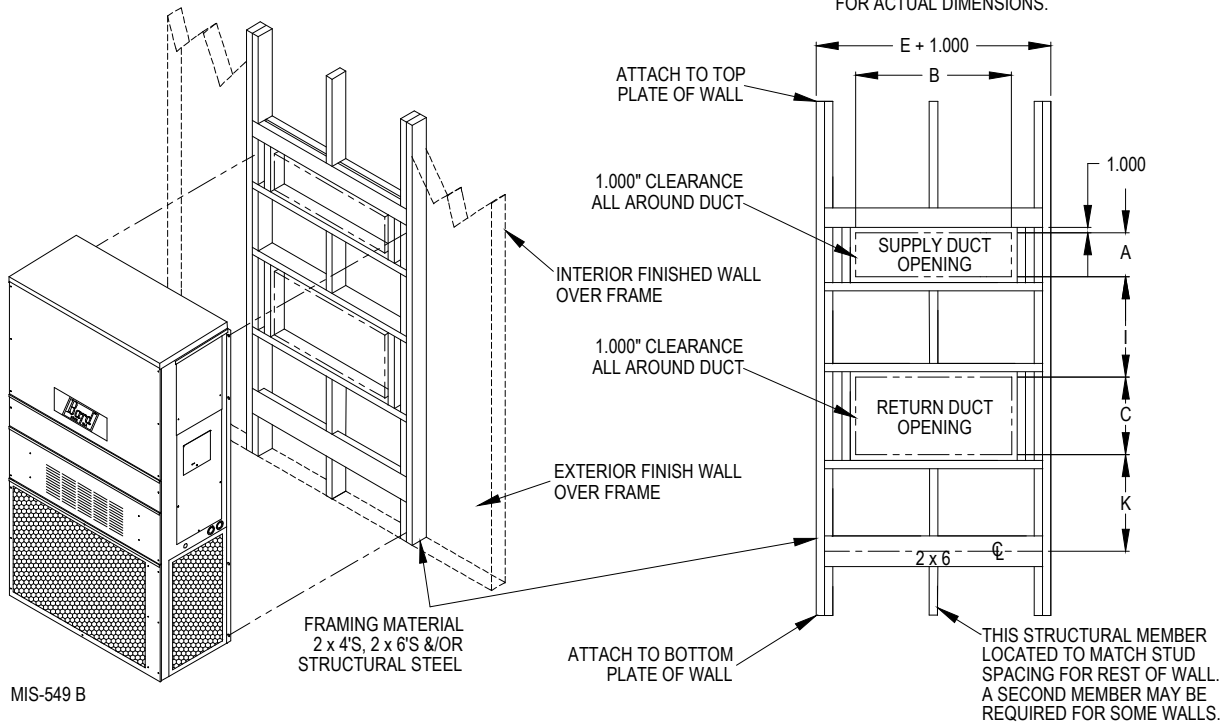

MIS-549 B

FIGURE 7
Common Wall Mounting Installations

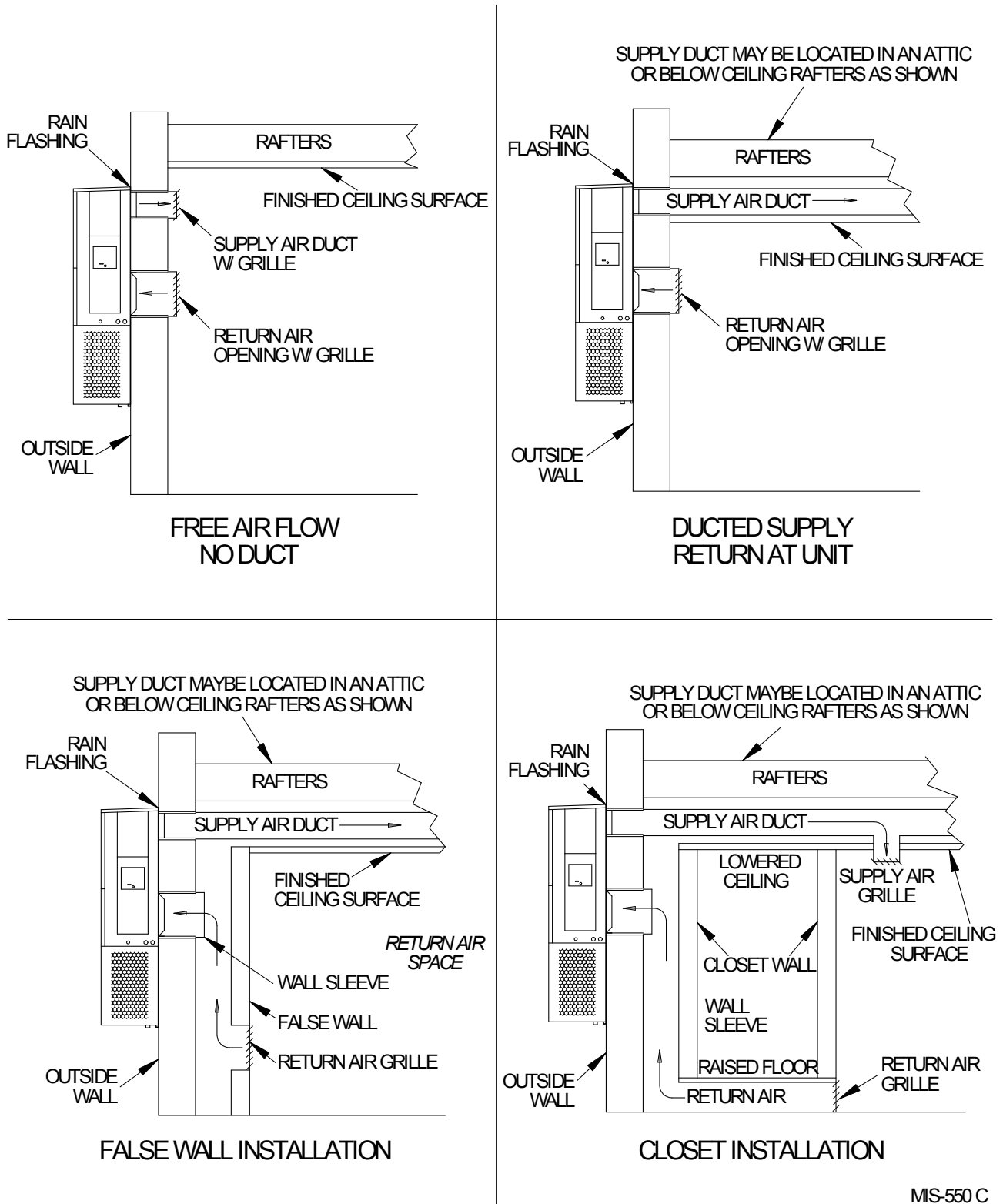

MS-550 C

WIRING – MAIN POWER

Refer to the unit rating plate for wire sizing information and maximum fuse or circuit breaker size. Each outdoor unit is marked with a “Minimum Circuit Ampacity”. This means that the field wiring used must be sized to carry that amount of current. Depending on the installed KW of electric heat, there may be two field power circuits required. If this is the case, the unit serial plate will so indicate. All models are suitable only for connection with copper wire. Each unit and/or wiring diagram will be marked “Use Copper Conductors Only”. These instructions **must be** adhered to. Refer to the National Electrical Code (NEC) for complete current carrying capacity data on the various insulation grades of wiring material. All wiring must conform to NEC and all local codes.

The electrical data lists fuse and wire sizes (75° C copper) for all models including the most commonly used heater sizes. Also shown are the number of field power circuits required for the various models with heaters.

The unit rating plate lists a “Maximum Time Delay Relay Fuse” or circuit breaker that is to be used with the equipment. The correct size must be used for proper circuit protection and also to assure that there will be no nuisance tripping due to the momentary high starting current of the compressor motor.

The disconnect access door on this unit may be locked to prevent unauthorized access to the disconnect. To convert for the locking capability, bend the tab located in the bottom left-hand corner of the disconnect opening under the disconnect access panel straight out. This tab will now line up with the slot in the door. When shut, a padlock may be placed through the hole in the tab preventing entry.

See “Start Up” section for important information on three phase scroll compressor start ups.

See Tables 7 and 8 on pages 26 and 27 for electrical specifications.

WIRING – LOW VOLTAGE WIRING

All 230/208V 1 phase and 3 phase equipment have dual primary voltage transformers. All equipment leaves the factory wired on 240V tap. For 208V operation, reconnect from 240V to 208V tap. The acceptable operating voltage range for the 240 and 208V taps are:

TAP	RANGE
240	253 – 216
208	220 – 187

NOTE: *The voltage should be measured at the field power connection point in the unit and while the unit is operating at full load (maximum amperage operating condition).*

For low voltage wiring, an 18 gauge copper, color-coded cable is recommended. See Table 4 on page 16 for more information.

Low Voltage Connections

These units use a 24-volt AC low voltage circuit. The “RT” terminal is the 24V transformer output, and the “R” terminal is the 24VAC *hot* terminal for the operation of the equipment. “RT” and “R” are connected with brass jumper bar which can be removed and “RT” and “R” connected to external NC (normally closed) contact such as a fire/smoke detector that will cause immediate shutdown of the equipment upon activation.

“C” terminal is *grounded*.

“G” terminal is the *fan input*.

“Y1” terminal is the *1st Stage input for cooling*.

“Y2” terminal is the *2nd Stage compressor input for cooling (if equipped with an economizer)*.

“B/W1” terminal is the *1st stage electric heat*.

“W2” terminal is the *2nd stage heat (if equipped)*.

“A” terminal is the *ventilation input*. This terminal energizes any factory-installed ventilation option and indoor blower.

“D” terminal is the *dehumidification input*. If installed, this terminal energizes any factory installed dehumidification option.

For units equipped with an alarm relay:

“L/1” terminal is the *normally closed contact on the relay*.

“2” terminal is the *normally open contact on the relay*.

“3” terminal is the *common contact on the relay*.

LOW VOLTAGE CONNECTIONS FOR DDC CONTROL		
	Standard Units	Units w/ Economizers
Fan Only	Energize G	Energize G
1st Stage Cooling Mode	Energize Y1, G	Energize Y1, G
2nd Stage Cooling Mode		Energize Y1, Y2, G
1st Stage Heating	Energize B/W1	Energize B/W1
2nd Stage Heating (if employed)	Energize B/W1, W2	Energize B/W1, W2
Ventilation	Energize A	Energize A
Dehumidification (if employed)	Energize D	Energize D

**TABLE 1
Wall Thermostats**

Part Number	Predominate Features
8403-057 (TH3110D1040)	1 stage Cool, 1 stage Heat; Electronic Non-Programmable; Auto or Manual changeover
8403-058 (TH5220D1151)	2 stage Cool, 2 stage Heat; Electronic Non-Programmable; HP or Conventional (Default: HP); Auto or Manual changeover
8403-059 (TH5220D1219/U)	2 stage Cool, 2 stage Heat; Electronic Non-Programmable; HP or Conventional (Default: AC); Auto or Manual changeover
8403-060 (1120-445)	3 stage Cool; 3 stage Heat; Electronic Programmable/Non-Programmable; HP or Conventional; Auto or Manual changeover; Dehumidification Output
CS9B-THO	3 Stage Heat, 3 Stage Cool; Programmable/Non-Programmable; HP or Conventional; Auto or Manual Changeover; Humidity Sensor w/ dehumidification; Motion Sensor w/ Intelligent Learning Control; BACnet-compatible
CS9B-THOC	3 Stage Heat, 3 Stage Cool, Programmable/Non-Programmable; HP or Conventional; Auto or Manual Changeover; Humidity Sensor w/ dehumidification; CO ₂ Sensor; Motion Sensor w/Intelligent Learning Control; BACnet-compatible
CS9BE-THO	3 Stage Heat, 3 Stage Cool, Programmable/Non-Programmable; HP or Conventional; Auto or Manual Changeover; Humidity Sensor w/ dehumidification; Motion Sensor w/ Intelligent Learning Control; BACnet-compatible; Ethernet-compatible
CS9BE-THOC	3 Stage Heat, 3 Stage Cool, Programmable/Non-Programmable; HP or Conventional; Auto or Manual Changeover; Humidity Sensor w/dehumidification; CO ₂ Sensor; Motion Sensor w/Intelligent Learning Control; BACnet-compatible; Ethernet-compatible

**TABLE 2
Humidity Controls**

Part Number	Predominate Features
8403-038 (H600A1014)	SPDT switching, pilot duty 50VA @ 24V Humidity range 20-80% RH
8403-047 (H200-10-21-10)	Electronic dehumidstat SPST closes-on-rise Humidity range 10-90% with adjustable stops

**TABLE 3
CO₂ Controller**

Part Number	Predominate Features
8403-067	Normally Open SPST relay closes-on-rise 24V dual wave length sensor. Default setting 950ppm, adjustable to 0-2000ppm Default off setting 1000ppm, adjustable to 0-200 ppm can be calibrated

**TABLE 4
Thermostat Wire Size**

Transformer VA	FLA	Wire Gauge	Maximum Distance In Feet
55	2.3	20 gauge	45
		18 gauge	60
		16 gauge	100
		14 gauge	160
		12 gauge	250

FIGURE 8
Programmable Thermostat Connections

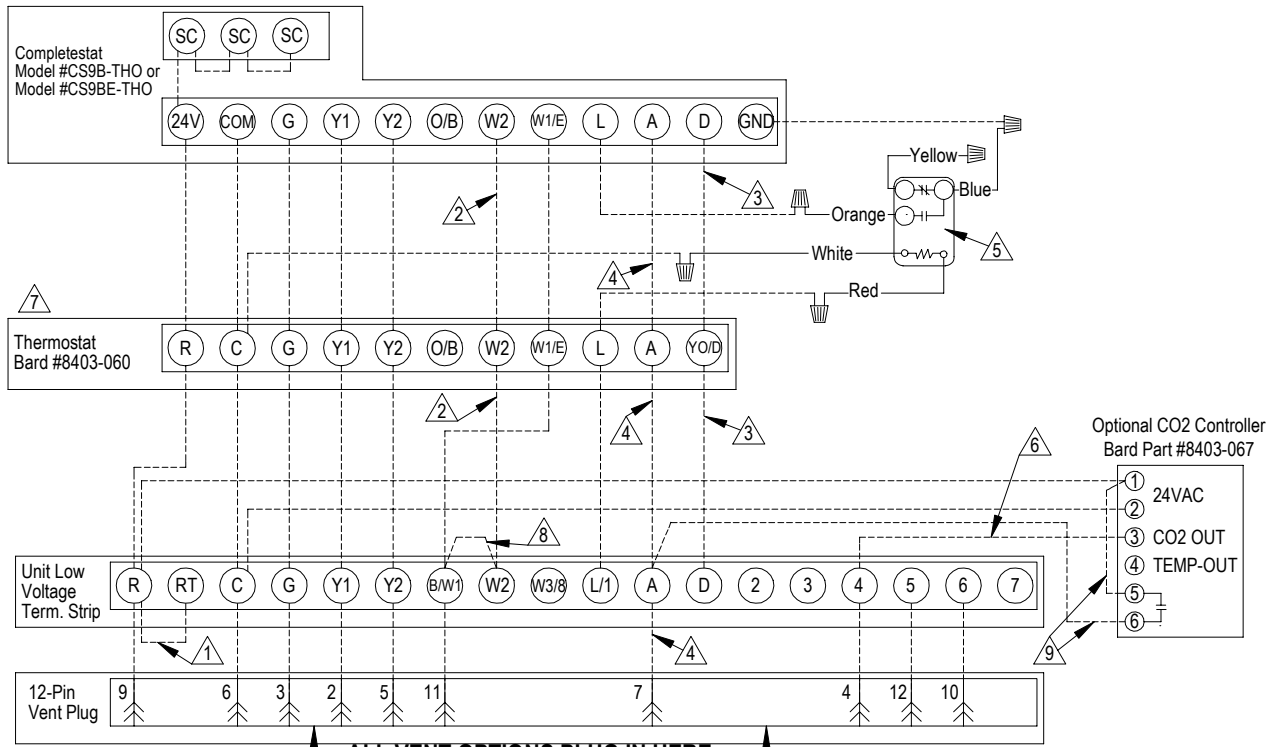

ALL VENT OPTIONS PLUG IN HERE

If not equipped with a ventilation option to plug in, a jumper plug must be installed.

- 1 Factory installed jumper. Remove jumper and connect to N.C fire alarm circuit if emergency shutdown required.
- 2 Wire not needed below 15KW.
- 3 Wire required for dehumidification models only.
- 4 Do not connect "A" from thermostat if optional CO2 controller is used
- 5 Relay Provided with Completestat
- 6 0-10 VDC modulating CO2 control signal for modulating ventilation control (optional for ECON only - see vent instruction manuals)
- 7 Change model configuration from heat pump to heat/cool. Must be configured to programmable and fan set to be programmed fan for the "A" output to function during scheduled occupied periods. Must be configured for multi-stage for Y1 output to be active 1st stage cooling. For dehumidification, must be configured for "No Economizer" for Y/O/D to be active for humidity control.
- 8 Install jumper for 1 stage electric heat on units with less than 15KW
- 9 Do not add these wires if setting up for modulating control. See note 7.

MIS-3738 A

FIGURE 9
Non-Programmable Thermostat Connections

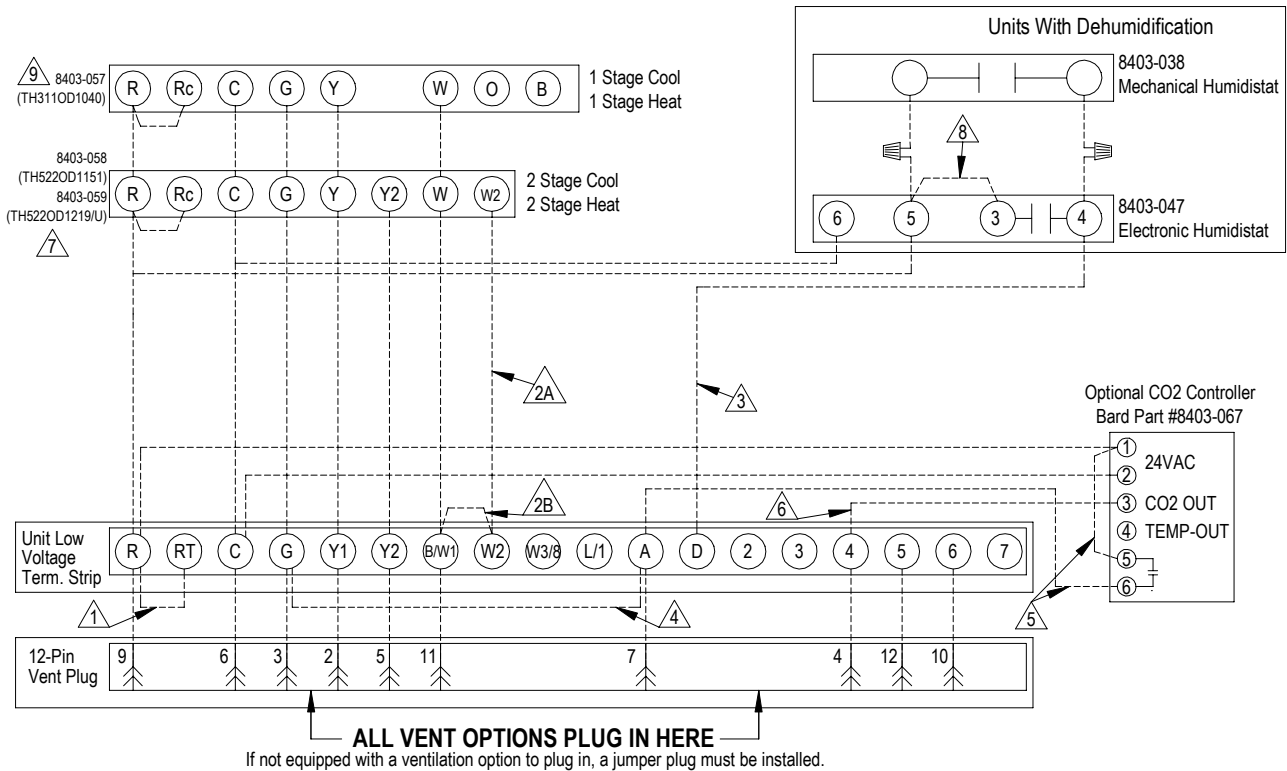

- ⚠ 1 Factory installed jumper. Remove jumper and connect to N.C fire alarm circuit if emergency shutdown required.
- ⚠ 2A Wire not needed below 15KW.
- ⚠ 2B Install Jumper for 1 stage electric heat on units with more than 10KW.
- ⚠ 3 Wire required for dehumidification models only.
- ⚠ 4 For vent operation, add jumper if optional CO2 controller is not used. Vent will run while blower is energized.
- ⚠ 5 Do not add these wires if setting up for modulating control. See note 7.
- ⚠ 6 0-10 VDC Modulating CO2 control signal for modulating ventilation control (Optional for ECON Only) - See vent installation manual.
- ⚠ 7 For 8403-058, change "system type", set up Function 1, From 5 (2 Heat/ 1 Cool heat Pump) to 6 (2 Heat / 2 Cool Conventional). For 8403-059, No change required.
- ⚠ 8 Jumper needs added.
- ⚠ 9 Thermostat will not work with units equipped with economizers.

MIS-3739 B

THESE UNITS REQUIRE R-410A REFRIGERANT AND POLYOL ESTER OIL.

GENERAL

1. Use separate service equipment to avoid cross contamination of oil and refrigerants.
2. Use recovery equipment rated for R-410A refrigerant.
3. Use manifold gauges rated for R-410A (800 psi/250 psi low).
4. R-410A is a binary blend of HFC-32 and HFC-125.
5. R-410A is nearly azeotropic—similar to R-22 and R-12. Although nearly azeotropic, charge with liquid refrigerant.
6. R-410A operates at 40-70% higher pressure than R-22 and systems designed for R-22 cannot withstand this higher pressure.
7. R-410A has an ozone depletion potential of zero, but must be reclaimed due to its global warming potential.
8. R-410A compressors use Polyol Ester oil.
9. Polyol Ester oil is hygroscopic; it will rapidly absorb moisture and strongly hold this moisture in the oil.
10. A liquid line dryer must be used—even a deep vacuum will not separate moisture from the oil.
11. Limit atmospheric exposure to 15 minutes.
12. If compressor removal is necessary, always plug compressor immediately after removal. Purge with small amount of nitrogen when inserting plugs.

TOPPING OFF SYSTEM CHARGE

If a leak has occurred in the system, Bard Manufacturing recommends reclaiming, evacuating (see criteria above) and charging to the nameplate charge. If done correctly, topping off the system charge can be done without problems.

With R-410A, there are no significant changes in the refrigerant composition during multiple leaks and recharges. R-410A refrigerant is close to being an azeotropic blend (it behaves like a pure compound or single component refrigerant). The remaining refrigerant charge, in the system, may be used after leaks have occurred and then “top-off” the charge by utilizing the pressure charts on the inner control panel cover as a guideline.

REMEMBER: When adding R-410A refrigerant, it must come out of the charging cylinder/tank as a liquid to avoid any fractionation, and to ensure optimal system performance. Refer to instructions for the cylinder that is being utilized for proper method of liquid extraction.



WARNING

Failure to conform to these practices could lead to damage, injury or death.

SAFETY PRACTICES

1. Never mix R-410A with other refrigerants.
2. Use gloves and safety glasses. Polyol Ester oils can be irritating to the skin, and liquid refrigerant will freeze the skin.
3. Never use air and R-410A to leak check; the mixture may become flammable.
4. Do not inhale R-410A—the vapor attacks the nervous system, creating dizziness, loss of coordination and slurred speech. Cardiac irregularities, unconsciousness and ultimate death can result from breathing this concentration.
5. Do not burn R-410A. This decomposition produces hazardous vapors. Evacuate the area if exposed.
6. Use only cylinders rated DOT4BA/4BW 400.
7. Never fill cylinders over 80% of total capacity.
8. Store cylinders in a cool area, out of direct sunlight.
9. Never heat cylinders above 125°F.
10. Never trap liquid R-410A in manifold sets, gauge lines or cylinders. R-410A expands significantly at warmer temperatures. Once a cylinder or line is full of liquid, any further rise in temperature will cause it to burst.

IMPORTANT INSTALLER NOTE

For improved start up performance, wash the indoor coil with a dishwashing detergent.

HIGH PRESSURE SWITCH

All W**A/W**L wall mounted air conditioner series models are supplied with a remote reset for the high and low pressure switch. If tripped, this pressure switch may be reset by turning the thermostat off then back on again.

THREE PHASE SCROLL COMPRESSOR START UP INFORMATION

Scroll compressors, like several other types of compressors, will only compress in one rotational direction. Direction of rotation is not an issue with single phase compressors since they will always start and run in the proper direction.

However, three phase compressors will rotate in either direction depending upon phasing of the power. Since there is a 50-50 chance of connecting power in such a way as to cause rotation in the reverse direction, verification of proper rotation must be made. Verification of proper rotation direction is made by observing that suction pressure drops and discharge pressure rises when the compressor is energized. Reverse rotation also results in an elevated sound level over that with correct rotation, as well as substantially reduced current draw compared to tabulated values.

Verification of **proper rotation** must be made at the time the equipment is put into service. If improper rotation is corrected at this time, there will be no negative impact on the durability of the compressor. However, reverse operation for over 1 hour may have a negative impact on the bearing due to oil pump out.

NOTE: *If compressor is allowed to run in reverse rotation for an extended period of time, the compressor's internal protector will trip.*

All three phase compressors are wired identically internally. As a result, once the correct phasing is determined for a specific system or installation, connecting properly phased power leads to the same Fusite terminal should maintain proper rotation direction.

The direction of rotation of the compressor may be changed by reversing any two line connections to the unit.

PHASE MONITOR

All units with three phase scroll compressors are equipped with a three phase line monitor to prevent compressor damage due to phase reversal.

The phase monitor in this unit is equipped with two LEDs. If the Y signal is present at the phase monitor and phases are correct, the green LED will light.

If phases are reversed, the red fault LED will be lit and compressor operation is inhibited.

If a fault condition occurs, reverse two of the supply leads to the unit. **Do not reverse any of the unit factory wires as damage may occur.**

CONDENSER FAN OPERATION

NOTE: *Certain models may be equipped with a low ambient control (LAC), and if so, the condenser fan motor will have a delayed start until system refrigerant operating pressure builds up. After starting, the fan motor may or may not cycle depending upon ambient conditions. This is normal operation.*

The condenser fan motor on 230/208 volt, one and three phase, 60 HZ units is a two-speed motor that comes factory wired on high speed for peak performance. If ambient conditions permit, it can be reconnected to low speed (red wire) for lower sound level. See wiring diagram. (*This applies to W42, W48, W60 and W72 models only.*)

50 HZ models must have fan wired on low speed. These models are factory wired on low speed.

SERVICE HINTS

1. Caution owner/operator to maintain clean air filters at all times and also not to needlessly close off supply and return air registers. This reduces airflow through the system, which shortens equipment service life as well as increasing operating costs.
2. Check all power fuses or circuit breakers to be sure they are the correct rating.
3. Periodic cleaning of the outdoor coil to permit full and unrestricted airflow circulation is essential.

SEQUENCE OF OPERATION

COOLING – Circuit R-Y1 makes at thermostat pulling in compressor contactor, starting the compressor and outdoor motor. (See **NOTE** above under Condenser Fan Operation concerning models equipped with low ambient control.) The G (indoor motor) circuit is automatically completed by the thermostat on any call for cooling operation or can be energized by manual fan switch on subbase for constant air circulation. On a call for heating, circuit R-W1 makes at the thermostat pulling in heat contactor for the strip heat and blower operation. On a call for second stage heat, R-W2 makes bringing on second heat contactor, if so equipped.

VENT CONNECTION PLUG

All units are equipped with a vent connection plug in the side of the control panel for the different ventilation packages to plug in to. If the compressor will not start and there is no "Y1" at the compressor control module,

first check to make sure that either the optional vent is plugged into the vent connection plug or the supplied jumper plug is in place. **The unit will not operate without anything plugged in.** This plug is located on the side of the control panel behind the front vent door (behind the filter access door). If the unit is supplied with a factory-installed vent package, it will be plugged in but the jumper plug will also be tethered next to the connection for troubleshooting purposes, if necessary.

COMPRESSOR CONTROL MODULE

The compressor control module is standard on all models covered by this manual. The compressor control module is an anti-short cycle/lockout timer with high and low pressure switch monitoring and alarm relay output.

Adjustable Delay-on-Make and Delay-on-Break Timer

On initial power up or anytime power is interrupted to the unit, the *delay-on-make* period begins, which will be 2 minutes plus 10% of the *delay-on-break* setting. When the delay-on-make is complete and the high pressure switch and low pressure switch are closed, the compressor contactor is energized. Upon shutdown, the delay-on-break timer starts and prevents restart until the delay-on-break and delay-on-make periods have expired.

During routine operation of the unit with no power interruptions, the compressor will operate on demand with no delay.

High Pressure Switch and Lockout Sequence

If the high pressure switch opens, the compressor contactor will de-energize immediately. The lockout timer will go into a *soft lockout* and stay in soft lockout until the high pressure switch closes and the delay-on-break time has expired. If the high pressure switch opens again in this same operating cycle, the unit will go into *manual lockout* condition and the alarm relay circuit will energize. Recycling the wall thermostat resets the manual lockout.

Low Pressure Switch, Bypass and Lockout Sequence

If the low pressure switch opens for more than 120 seconds, the compressor contactor will de-energize and go into a soft lockout. Regardless the state of the low pressure switch, the contactor will re-energize after the delay-on-make time delay has expired. If the low pressure switch remains open, or opens again for longer than 120 seconds, the unit will go into manual lockout condition and the alarm relay circuit will energize. Recycling the wall thermostat resets the manual lockout.

Alarm Relay Output

Alarm terminal is output connection for applications where alarm relay is employed. This terminal is powered whenever the compressor is locked out due to HPC or LPC sequences as described.

NOTE: *Both high and low pressure switch controls are inherently automatic reset devices. The high pressure switch and low pressure switch cut out and cut in settings are fixed by specific air conditioner unit model. The lockout features, both soft and manual, are a function of the compressor control module.*

Adjustments

Adjustable Delay-on-Make and Delay-on-Break Timer

The potentiometer is used to select delay-on-break time from 30 seconds to 5 minutes. Delay-on-make (DOM) timing on power up and after power interruptions is equal to 2 minutes plus 10% of delay-on-break (DOB) setting:

0.5 minute (30 seconds) DOB = 123 second DOM
1.0 minute (60 seconds) DOB = 126 second DOM
2.0 minute (120 seconds) DOB = 132 second DOM
3.0 minute (180 seconds) DOB = 138 second DOM
4.0 minute (240 seconds) DOB = 144 second DOM
5.0 minute (300 seconds) DOB = 150 second DOM

During routine operation of the unit with no power interruptions, the compressor will operate on demand with no delay.

Typical Settings for Dual Unit Installation:

Unit 1: DOB set at 2 minutes and DOM is 132 seconds

Unit 2: DOB set at 4 minutes and DOM is 144 seconds

PRESSURE SERVICE PORTS

High and low pressure service ports are installed on all units so that the system operating pressures can be observed. A pressure table covering all models can be found on page 25. It is imperative to match the correct pressure table to the unit by model number.

This unit employs high-flow Coremax valves instead of the typical Shrader type valves.

WARNING! Do NOT use a Schrader valve core removal tool with these valves. Use of such a tool could result in eye injuries or refrigerant burns!

To change a Coremax valve without first removing the refrigerant, a special tool is required which can be obtained at www.fastestinc.com/en/SCCA07H. See the replacement parts manual for replacement core part numbers.

SERVICE

TROUBLESHOOTING NIDEC SELECTECH SERIES ECM MOTORS

If the Motor Is Running

1. It is normal for the motor to rock back and forth on start up. Do not replace the motor if this is the only problem identified.
2. If the system is excessively noisy, does not appear to change speeds in response to a demand (Heat, Cool, Other) or is having symptoms during the cycle such as tripping limit or freezing coil, check the following:
 - A. Wait for programmed delays to time out.
 - B. Ensure that the motors control inputs are wired as shown in the factory-supplied wiring diagram to ensure motor is getting proper control signals and sequencing.
 - C. Remove the filter and check that all dampers, registers and grilles are open and free flowing. If removing the filters corrects the problem, clean or replace with a less restrictive filter. Also check and clean the blower wheel or coil as necessary.

- D. Check the external static pressure (total of both supply and return) to ensure it is within the range as listed on the unit serial plate. If higher than allowed, additional duct work is needed.
- E. If the motor does not shut off at the end of the cycle, wait for any programmed delays to time out (no more than 90 seconds). Also make sure that there is no call for "Continuous Fan" on the "G" terminal.
- F. If the above diagnostics do not solve the problem, confirm the voltage checks in the next section below, then continue with the "Model SelecTech Communication Diagnostics".

If the Motor Is Not Running

1. Check for proper high voltage and ground at the (L/L1) (G) (N/L2) connections at the motor (see Figure 10). Correct any voltage issues before proceeding to the next step. The SelecTech motor is voltage specific. Only the correct voltage should be applied to the proper motor. Input voltage within plus or minus 10% of the nominal Line Power VAC is acceptable.

FIGURE 10
Motor Connections

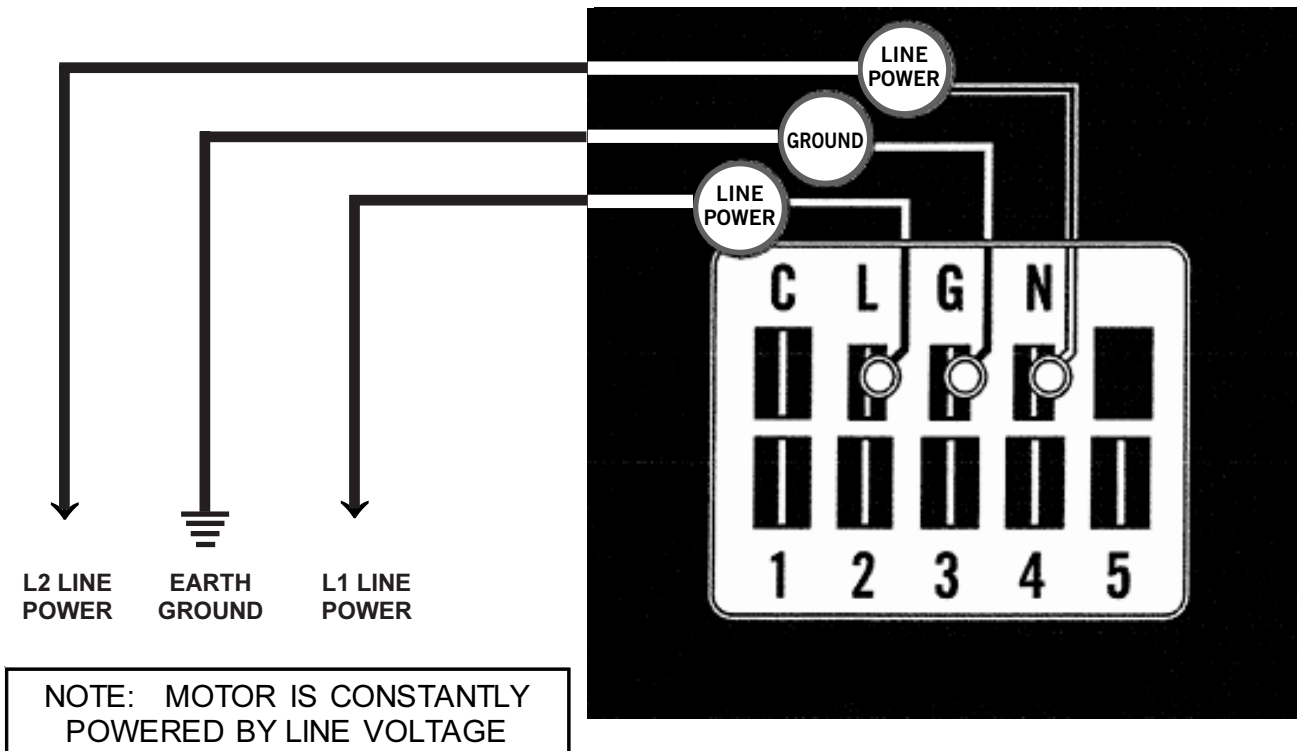

2. If the motor has proper high voltage and ground at the (L/L1) (G) (N/L2) connections, then continue with the "Model SelecTech Communication Diagnostics".

Model SelecTech Communication Diagnostics

The SelecTech motor is communicated through 24 VAC low voltage (Thermostat Control Circuit Wiring).

1. Start with unit wiring diagram to confirm proper connections and voltage (see Figure 11).
2. Initiate a demand from the thermostat and check the voltage between the common and the appropriate motor terminal (1-5). ("G" input is typically on terminal #1, but always refer to wiring diagram.)

- A. If the low voltage communication is not present, check the demand from the thermostat. Also check the output terminal and wire(s) from the terminal strip or control relay(s) to the motor.
- B. If the motor has proper high voltage as identified above (Motor not Running #1), proper low voltage to a programmed terminal and is not operating, the motor is failed and will require replacement.

**FIGURE 11
Motor Connections**

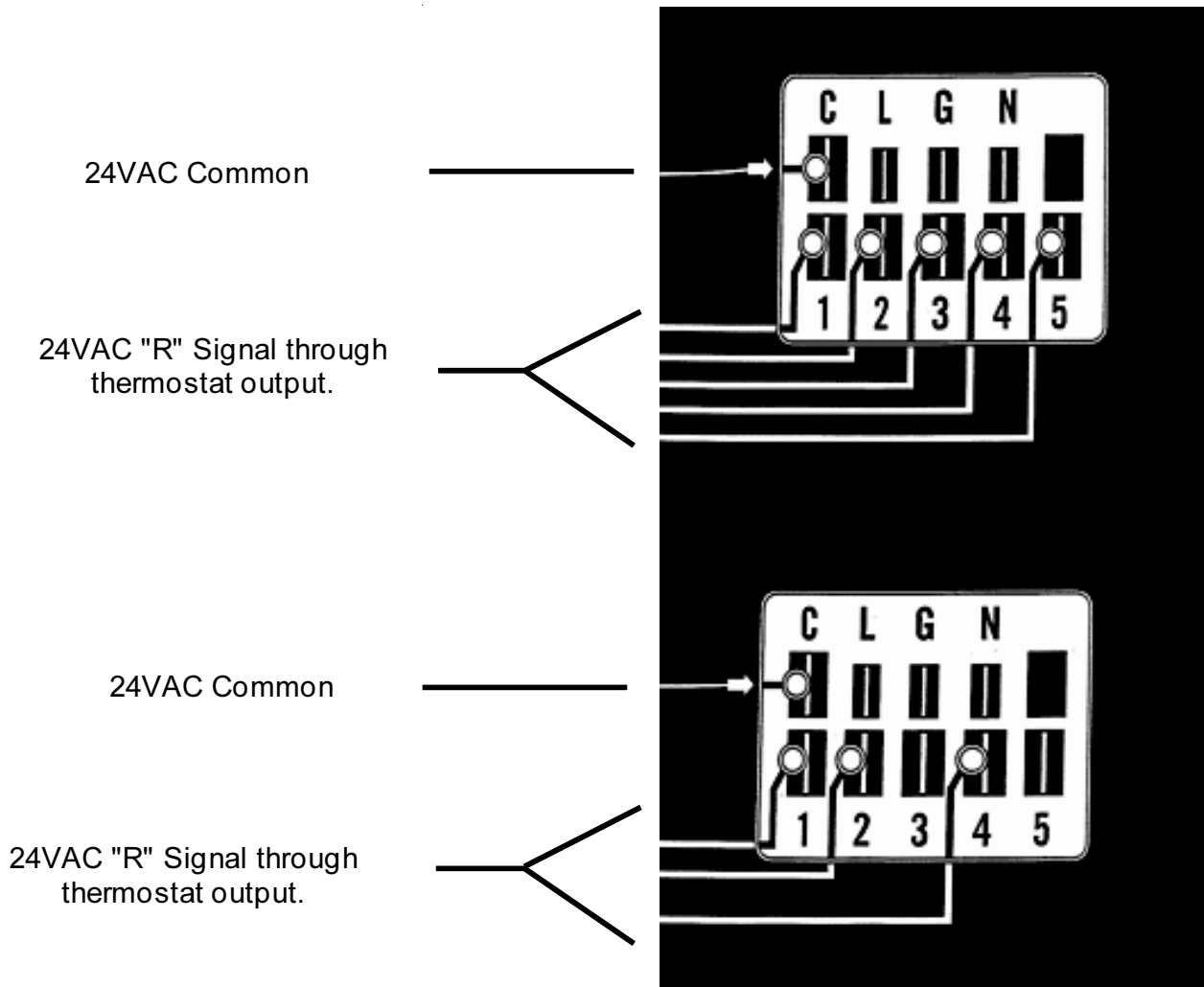

FAN BLADE SETTING DIMENSIONS

Shown in Figure 12 is the correct fan blade setting for proper air delivery across the outdoor coil. Refer to Table 5 for unit specific dimension.

Any service work requiring removal or adjustment in the fan and/or motor area will require that the dimensions below be checked and blade adjusted in or out on the motor shaft accordingly.

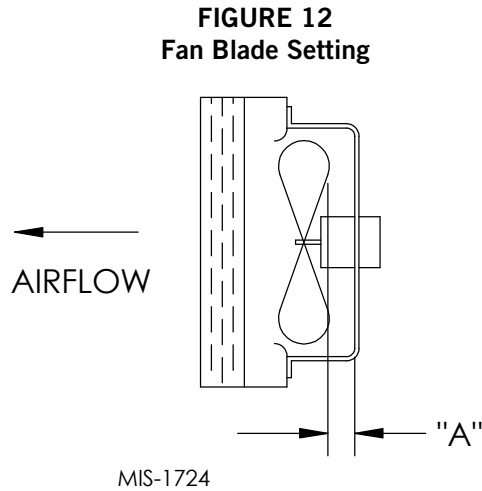

TABLE 5
Fan Blade Dimension

Model	Dimension A
W18AA/W18LA W24AA/W24LA	1.00"
W30AA/W30LA W36AA/W36LA	1.25"
W42AA/W42LA W48AA/W48LA W60AA/W60LA W72AA/W72LA	1.75"

R-410A REFRIGERANT CHARGE

This unit was charged at the factory with the quantity of refrigerant listed on the serial plate. AHRI capacity and efficiency ratings were determined by testing with this refrigerant charge quantity.

The following pressure table shows nominal pressures for the units. Since many installation specific situations can affect the pressure readings, this information should only be used by certified technicians as a guide for evaluating proper system performance. They shall not be used to adjust charge. If charge is in doubt, reclaim, evacuate and recharge the unit to the serial plate charge.

REMOVAL OF FAN SHROUD

1. Disconnect all power to the unit.
2. Remove the screws holding both grilles, one on each side of unit, and remove grilles.
3. Remove nine screws holding fan shroud to condenser and bottom.
4. Unwire condenser fan motor.
5. Slide complete motor, fan blade and shroud assembly out the left side of the unit.
6. Service motor/fan as needed.
7. Reverse steps to reinstall.

TABLE 6
Cooling Pressure

Air Temperature Entering Outdoor Coil °F

Model	Return Air Temp (DB/WB)	Pressure	75	80	85	90	95	100	105	110	115	120	125
W18A/L	75/62	Low Side High Side	121 293	123 312	126 332	128 353	131 376	134 400	136 425	137 452	140 480	142 510	144 540
	80/67	Low Side High Side	129 300	132 320	135 340	137 362	140 386	143 410	145 436	147 464	150 492	152 523	154 554
	85/72	Low Side High Side	134 311	137 331	140 352	142 375	145 400	148 424	150 451	152 480	155 509	157 541	159 573
W24A/L	75/62	Low Side High Side	123 314	124 334	126 355	128 377	129 401	131 425	133 451	135 479	137 507	139 536	141 567
	80/67	Low Side High Side	132 322	133 343	135 364	137 387	138 411	140 436	142 463	144 491	146 520	149 550	151 582
	85/72	Low Side High Side	137 333	138 355	140 377	142 401	143 425	145 451	147 479	149 508	151 538	154 569	156 602
W30A/L	75/62	Low Side High Side	118 312	120 333	122 355	124 378	126 403	128 428	131 454	133 483	135 511	137 540	138 570
	80/67	Low Side High Side	126 320	128 342	131 364	133 388	135 413	137 439	140 466	142 495	144 524	146 554	148 585
	85/72	Low Side High Side	130 331	132 354	136 377	138 402	140 427	142 454	145 482	147 512	149 542	151 573	153 605
W36A/L	75/62	Low Side High Side	117 323	120 346	122 370	124 394	127 419	129 446	131 473	134 500	136 528	137 558	138 587
	80/67	Low Side High Side	125 331	128 355	130 379	133 404	136 430	138 457	140 485	143 513	145 542	147 572	148 602
	85/72	Low Side High Side	129 343	132 367	135 392	138 418	141 445	143 473	145 502	148 531	150 561	152 592	153 623
W42A/L	75/62	Low Side High Side	123 323	125 346	128 371	130 395	132 421	135 447	137 474	138 501	140 528	142 558	144 587
	80/67	Low Side High Side	132 331	134 355	137 380	139 405	141 432	144 458	146 486	148 514	150 542	152 572	154 602
	85/72	Low Side High Side	137 343	139 367	142 393	144 419	146 447	149 474	151 503	153 532	155 561	157 592	159 623
W48A/L	75/62	Low Side High Side	120 330	122 353	125 377	127 402	130 428	132 454	134 482	136 510	137 540	139 570	141 601
	80/67	Low Side High Side	128 338	131 362	134 387	136 412	139 439	141 466	143 494	145 523	147 554	149 585	151 616
	85/72	Low Side High Side	132 350	136 375	139 401	141 426	144 454	146 482	148 511	150 541	152 573	154 605	156 638
W60A/L	75/62	Low Side High Side	127 344	129 362	131 380	134 401	136 421	137 444	140 467	142 492	145 518	148 545	151 573
	80/67	Low Side High Side	136 353	138 371	140 390	143 411	145 432	147 455	150 479	152 505	155 531	158 559	161 588
	85/72	Low Side High Side	141 365	143 384	145 404	148 425	150 447	152 471	155 496	157 523	160 550	164 579	167 609
W72A/L	75/62	Low Side High Side	117 332	119 353	121 376	122 402	124 427	126 454	128 483	130 512	132 542	134 574	136 607
	80/67	Low Side High Side	125 340	127 362	129 386	131 412	133 438	135 466	137 495	139 525	141 556	143 589	145 623
	85/72	Low Side High Side	129 352	131 375	134 400	136 426	138 453	140 482	142 512	144 543	146 575	148 610	150 645

Low side pressure ± 4 PSIG
High side pressure ± 10 PSIG

Tables are based upon rated CFM (airflow) across the evaporator coil. If there is any doubt as to correct operating charge being in the system, the charge should be removed and system evacuated and recharged to serial plate charge weight.

NOTE: Pressure table based on high speed condenser fan operation. If condensing pressures appear elevated check condenser fan wiring. See "Condenser Fan Operation".

TABLE 8

Electrical Specifications – W*L Series														
MODEL	Rated Volts & Phase	No. Field Power Circuits	Single Circuit				Dual Circuit							
			③ Minimum Circuit Ampacity	① Maximum External Fuse or Ckt. Brkr.	② Field Power Wire Size	② Ground Wire	③ Minimum Circuit Ampacity		① Maximum External Fuse or Ckt. Breaker		② Field Power Wire Size		② Ground Wire Size	
							Ckt. A	Ckt. B	Ckt. A	Ckt. B	Ckt. A	Ckt. B	Ckt. A	Ckt. B
W18LA-A00, A0Z A05 A08 A10	230/208-1	1	16	20	12	12								
		1	30	30	10	10								
		1	46	50	8	10								
		1	56	60	6	10								
W24LA-A00, A0Z A05 A08 A10	230/208-1	1	21	30	10	10								
		1	30	30	10	10								
		1	46	50	8	10								
		1	56	60	6	10								
W24LA-B00, B0Z B06	230/208-3	1	15	20	12	12								
		1	22	25	10	10								
W24LA-C00, C0Z C06	460-3	1	9	15	14	14								
		1	11	15	14	14								
W30LA-A00, A0Z A05 A08 A10 A15	230/208-1	1	26	35	8	10								
		1	32	35	8	10								
		1	47	50	8	10								
		1	58	60	6	10								
		1 or 2	84	90	4	8	58	26	60	30	6	10	10	10
W30LA-B00, B0Z B09 B15	230/208-3	1	19	20	12	12								
		1	33	35	8	10								
		1	51	60	6	10								
W30LA-C00, C0Z C09 C15	460-3	1	9	15	14	14								
		1	17	20	12	12								
		1	26	30	10	10								
W36LA-A00, A0Z A05 A10 A15	230/208-1	1	29	35	8	10								
		1	32	35	8	10								
		1	58	60	6	10								
		1 or 2	84	90	4	8	58	26	60	30	6	10	10	10
W36LA-B00, B0Z B09 B15	230/208-3	1	23	30	10	10								
		1	33	35	8	10								
		1	51	60	6	10								
W36LA-C00, C0Z C09 C15	460-3	1	11	15	14	14								
		1	17	20	12	12								
		1	26	30	10	10								
W42LA-A00, A0Z A05 A10 A15	230/208-1	1	32	50	8	10								
		1	32	50	8	10								
		1	58	60	6	10								
		1 or 2	84	90	4	8	58	26	60	30	6	10	10	10
W42LA-B00, B0Z B06 B09 B15	230/208-3	1	25	35	8	10								
		1	25	35	8	10								
		1	33	35	8	10								
		1	51	60	6	10								
W42LA-C00, C0Z C09 C15	460-3	1	12	15	14	14								
		1	17	20	12	12								
		1	26	30	10	10								
W48LA-A00, A0Z A05 A10 A15	230/208-1	1	34	50	8	10								
		1	34	50	8	10								
		1	58	60	6	10								
		1 or 2	84	90	4	8	58	26	60	30	6	10	10	10
W48LA-B00, B0Z B06 B09 B15	230/208-3	1	26	35	8	10								
		1	26	35	8	10								
		1	33	35	8	10								
		1	51	60	6	10								
W48LA-C00, C0Z C09 C15	460-3	1	12	15	14	14								
		1	17	20	12	12								
		1	26	30	10	10								
W60LA-A00, A0Z A05 A10 A15	230/208-1	1	38	60	8	10								
		1	38	60	8	10								
		1	60	60	6	10								
		1 or 2	86	90	3	8	60	26	60	30	6	10	10	10
W60LA-B00, B0Z B06 B09 B15	230/208-3	1	27	40	8	10								
		1	27	40	8	10								
		1	35	40	8	10								
		1	53	60	6	10								
W60LA-C00, C0Z C09 C15	460-3	1	14	20	12	12								
		1	18	20	12	12								
		1	27	30	10	10								
W72LA-A00, A0Z A05 A10 A15	230/208-1	1	58	60	6	10								
		1	58	60	6	10								
		1	62	70	6	8	58	26	60	30	6	10	10	10
		1 or 2	88	90	3	8	58	52	60	60	6	6	10	10
W72LA-B00, B0Z B06 B09 B15	230/208-3	1	40	60	8	10								
		1	40	60	8	10								
		1	40	60	8	10								
		1	55	60	6	10								
W72LA-C00, C0Z C09 C15	460-3	1	18	25	10	10								
		1	18	25	10	10								
		1	27	30	10	10								

- ① Maximum size of the time delay fuse or circuit breaker for protection of field wiring conductors.
- ② Based on 75°C copper wire. All wiring must conform to the National Electrical Code and all local codes.
- ③ These “Minimum Circuit Ampacity” values are to be used for sizing the field power conductors. Refer to the National Electrical code (latest version), Article 310 for power conductor sizing.

CAUTION: When more than one field power circuit is run through one conduit, the conductors must be derated. Pay special attention to Note 8 of Table 310 regarding Ampacity Adjustment Factors when more than three current carrying conductors are in a raceway.

IMPORTANT: While this electrical data is presented as a guide, it is important to electrically connect properly sized fuses and conductor wires in accordance with the National Electrical Code and all local codes.

TABLE 9
Recommended Airflow

Model	Nominal Rated CFM *	Nominal Rated ESP *	Recommended Airflow Range	Factory Speed Connection
W18A, W18L	600	.35	550 - 725	Low
W24A, W24L	800	.30	700 - 950	Single
W30A, W30L	1000	.45	900 - 1200	High
W36A, W36L	1100	.30	1000 - 1300	High
W42A, W42L	1350	.40	1250 - 1600	Low
W48A, W48L	1550	.35	1450 - 1750	High
W60A, W60L	1800	.30	1700 - 2000	High
W72A, W72L	1900	.25	1800 - 2100	Medium

* Rated CFM and ESP on factory speed connection.

TABLE 10
Indoor Blower Performance

Speed	W18				W24		W30				W36				W42				W48				W60						W72					
	High		Low		Single		High		Low		High		Low		High		Low		High		Low		High		Low		High		Medium		Low			
ESP (Inch H2O)	Dry Coil	Wet Coil	Dry Coil	Wet Coil	Dry Coil	Wet Coil	Dry Coil	Wet Coil	Dry Coil	Wet Coil	Dry Coil	Wet Coil	Dry Coil	Wet Coil	Dry Coil	Wet Coil	Dry Coil	Wet Coil	Dry Coil	Wet Coil	Dry Coil	Wet Coil	Dry Coil	Wet Coil	Dry Coil	Wet Coil	Dry Coil	Wet Coil	Dry Coil	Wet Coil				
0.0	1000	985	720	720	1010	975	1445	1380	940	930	1400	1310	965	955	1980	1940	1800	1705	2000	1940	1750	1700	2105	2010	1540	1460	2255	2155	2075	2015	1995	1930		
0.1	965	950	700	690	960	925	1385	1320	930	920	1340	1260	940	930	1905	1880	1700	1640	1910	1865	1675	1615	2045	1960	1480	1395	2185	2095	2010	1965	1950	1870		
0.2	935	900	665	660	905	870	1305	1240	920	910	1265	1185	905	890	1820	1760	1615	1565	1820	1770	1600	1540	1970	1885	1400	1315	2115	2035	1960	1915	1885	1825		
0.3	880	845	635	625	835	800	1220	1150	985	880	1180	1100	860	850	1735	1665	1530	1450	1720	1605	1500	1425	1895	1800	1300	1220	2050	1970	1915	1865	1835	1785		
0.4	795	760	590	575	750	720	1125	1055	850	830	1080	1010	800	785	1615	1565	1425	1350	1575	1500	1375	1320	1800	1700	1220	1150	1985	1920	1860	1815	1780	1720		
0.5	680	645	520	510	640	610	1020	950	785	750	970	895	705	680	1510	1380	1100	1000	1420	1190	1075	1030	1705	1605	1110	1070	1925	1855	1810	1765	1725	1615		

TABLE 11
Maximum ESP of Operation
Electric Heat Only

Model	W18A/L, W24A/L	W30A/L, W36A/L		W42A/L, W48A/L		W60A/L, W72A/L	
Outlet	FRONT	FRONT		FRONT		FRONT	
Speed	Single	High	Low	High	Low	High	Low
-A0Z	.50	.50	.50	.50	.50	.50	.50
-A04	.50						
-A05	.50	.50	.50	.50	.50	.50	.50
-A08	.50	.50	.50	.50	.50	.50	.50
-A10	.30	.40	.35	.50	.50	.50	.50
-A15		.40	.35	.50	.50	.50	.50
-A20				.50	.45	.50	.40
-B0Z	.50	.50	.50	.50	.50	.50	.50
-B06	.40	.50	.40	.50	.50	.50	.50
-B09		.50	.50	.50	.50	.50	.50
-B15		.35	.30	.50	.50	.50	.50
-B18				.50	.50	.50	.50
-C0Z	.50	.50	.50	.50	.50	.50	.50
-C06	.50	.50	.50				
-C09		.50	.40	.50	.50	.50	.50
-C15		.45	.35	.50	.50	.50	.50

Values shown are for units equipped with standard 1" throwaway filter or 1" washable filter. Derate ESP by .15 for 2" pleated filters.

**TABLE 12
Electric Heat**

Models	240V-1		208V-1		240V-3		208V-3		460V-3		
	KW	Amps	BTUH	Amps	BTUH	Amps	BTUH	Amps	BTUH	Amps	BTUH
4	16.7	13650	14.4	10240							
5	20.8	17065	18.1	12800							
6					14.4	20500	12.5	15360	7.2	20500	
8	33.3	27300	28.8	20475							
9					21.7	30600	18.7	23030	10.8	30700	
10	41.6	34130	36.2	25600							
12									14.4	40950	
15	62.5	51250	54.0	38400	36.2	51200	31.2	38400	18.0	51200	
18					43.3	61430	37.5	46100			
20	83.2	68260	72.1	51200							

TABLE 13
Vent and Control Options

Part Number	Description	W18, W24	W30, W36	W42, W48, W60, W72
CMA-14	ODT	X	X	X
CMC-15	Start Kit (230V 1-Phase)	X	X	X
CMA-31	DDC	X	X	
CMA-30	DDC			X
CMA-28	LAC	X	X	X
BFAD-2	Barometric Fresh Air Damper - Standard	X		
BOP-2	Blank Off Plate	X		
WMFADP2	Motorized Fresh Air Damper	X		
WCRVPS2	Commercial Ventilator - Spring Return	X		
WECOPE2	Economizer - Bldg. Equipment, Enthalpy	X		
WECOPT2	Economizer - Bldg. Equipment, DB Temp.	X		
WERVPA2	Energy Recovery Ventilator - 230 Volt	X		
WERVPC2	Energy Recovery Ventilator - 460 Volt	X		
BFAD-3	Barometric Fresh Air Damper - Standard		X	
BOP-3	Blank Off Plate		X	
WMFADP3	Motorized Fresh Air Damper		X	
WCRVPS3	Commercial Ventilator - Spring Return		X	
WECOPE3	Economizer - Bldg. Equipment, Enthalpy		X	
WECOPT3	Economizer - Bldg. Equipment, DB Temp.		X	
WERVPA3	Energy Recovery Ventilator - 230 Volt		X	
WERVPC3	Energy Recovery Ventilator - 460 Volt		X	
BFAD-5	Barometric Fresh Air Damper - Standard			X
BOP-5	Blank Off Plate			X
WMFADP5	Motorized Fresh Air Damper			X
WCRVPS5	Commercial Ventilator - Spring Return			X
WECOPE5	Economizer - Bldg. Equipment, Enthalpy			X
WECOPT5	Economizer - Bldg. Equipment, DB Temp.			X
WERVPA5	Energy Recovery Ventilator - 230 Volt			X
WERVPC5	Energy Recovery Ventilator - 460 Volt			X

TABLE 14A
Optional Accessories – Right Hand

	W18AA-A	W24AA-A	W24AA-B	W24AA-C	W30AA-A	W30AA-B	W30AA-C	W36AA-A	W36AA-B	W36AA-C	W42AA-A	W42AA-B	W42AA-C	W48AA-A	W48AA-B	W48AA-C	W60AA-A	W60AA-B	W60AA-C	W72AA-A	W72AA-B	W72AA-C	
Heater Kits	EHW2TA-A05	X	X																				
	EHW2TA-A08	X	X																				
	EHW2TA-A10	X	X																				
	EHWA24-A04B		X																				
	EHW2TA-B06			X																			
	EHWH24B-C06				X																		
	EHW3TA-A05					X			X														
	EHW3TA-A08					X			X														
	EHW3TA-A10					X			X														
	EHW3TA-A15					X			X														
	EHW30A-B06						X																
	EHW3TA-B06									X													
	EHW3TA-B09						X			X													
	EHW3TA-B15						X			X													
	EHW3TA-C06							X			X												
	EHW3TA-C09							X			X												
	EHW3TA-C12							X			X												
	EHW3TA-C15							X			X												
	EHW4TA-A05											X			X								
	EHWA05-A10B										X				X			X					
	EHWA05-A15B										X				X			X					
	EHWA05-A20B										X				X			X					
	EHW4TA-B06											X				X			X				
	EHWA05-B09B											X				X							
	EHW6TA-B06																						X
	EHWA05-B15B											X				X			X				X
	EHW5TA-B18																		X				
	EHW4TA-B18											X				X							
	EHW4TA-C09												X				X			X			X
	EHW4TA-C15												X				X			X			X
	EHW5TA-A05																	X			X		
	EHW60A-B09B																		X				
	EHW70A-B09B																						X
EHW6TA-B18																						X	
EHW72A-A10B																					X		
EHW72A-A15B																					X		
EHW72A-A20B																					X		
Circuit Breaker (WMCB) and Pull Disconnect (WMPD)	WMCB-01B			X																			
	WMCB-02A	X																					
	WMCB-02B					X																	
	WMCB-03A		X																				
	WMCB-04B							X															
	WMCB-05A					X			X														
	WMCB-05B										X					X							
	WMCB-06B																	X					
	WMCB-08A										X				X								
	WMCB-09A																	X			X		
	WMPD-01C				X			X			X			X			X			X			X
	WMCB-08B																					X	

TABLE 14B
Optional Accessories – Left Hand

	W18LA-A	W24LA-A	W24LA-B	W30LA-A	W30LA-B	W30LA-C	W36LA-A	W36LA-B	W36LA-C	W42LA-A	W42LA-B	W42LA-C	W48LA-A	W48LA-B	W48LA-C	W60LA-A	W60LA-B	W60LA-C	W72LA-A	W72LA-B	W72LA-C	
Heater Kits	EHW2TA-A05L	X	X																			
	EHW2TA-A08L	X	X																			
	EHW2TA-A10L	X	X																			
	EHW2TA-B06L			X																		
	EHW3TA-A05L				X		X															
	EHW3TA-A08L				X																	
	EHW3TA-A10L				X		X															
	EHW3TA-A15L				X		X															
	EHW3TA-B09L					X		X														
	EHW3TA-B15L					X		X														
	EHW3TA-C09L						X		X													
	EHW3TA-C15L						X		X													
	EHW4TA-A05L									X				X			X					
	EHWA05-A10LB									X				X			X					
	EHWA05-A15LB									X				X			X					
	EHW4TA-B06L										X				X			X				
	EHWA05-B09LB										X				X							
	EHW6TA-B06L																					X
	EHWA05-B15LB										X				X			X				X
	EHW4TA-C09L											X				X			X			X
	EHW4TA-C15L											X				X			X			X
	EHW6TA-A05L																				X	
	EHWA60-B09LB																	X				
EHW70A-B09LB																					X	
EHW72A-A10LB																				X		
EHW72A-A15LB																				X		
Circuit Breaker (WMCB) and Pull Disconnect (WMPD)	WMCB-01B			X																		
	WMCB-02A	X																				
	WMCB-02B				X																	
	WMCB-03A		X																			
	WMCB-04B						X															
	WMCB-05A				X		X															
	WMCB-05B									X			X									
	WMCB-06B																X					
	WMCB-08A								X		X											
	WMCB-09A															X			X			
WMPD-01C					X		X			X			X			X		X			X	
WMCB-09B																				X		