

---

# SERVICE INSTRUCTIONS

---

## MULTI-TEC® WALL-MOUNT AIR CONDITIONER *Part of the Bard Free Cooling System*

Models:

W18AAPA	W42AAEA	W60AAEA	W72ABEA	W18LAPA	W60LAPA
W24AAPA	W42AAEB	W60AAEB	W72ABEB	W24LAPA	W60LAPB
W24AAPB	W42AAEC	W60AAEC	W72ABEC	W24LAPB	W60LAPC
W24AAPC	W42AAPA	W60AAEQ	W72ABEQ	W30LAPA	W60LAPQ
W30AAPA	W42AAPB	W60AAMA	W72ABMA	W30LAPB	W72LBPA
W30AAPB	W42AAPC	W60AAMB	W72ABMB	W30LAPC	W72LBPB
W30AAPC	W48AAEA	W60AAMC	W72ABMC	W36LAPA	W72LBPC
W36AAEA	W48AAEB	W60AAPA	W72ABPA	W36LAPB	W72LBPQ
W36AAEB	W48AAEC	W60AAPB	W72ABPB	W36LAPC	
W36AAEC	W48AAEQ	W60AAPC	W72ABPC	W42LAPA	
W36AAMA	W48AAMA	W60AAPQ	W72ABPQ	W42LAPB	
W36AAMB	W48AAMB			W42LAPC	
W36AAMC	W48AAMC			W48LAPA	
W36AAPA	W48AAPA			W48LAPB	
W36AAPB	W48AAPB			W48LAPC	
W36AAPC	W48AAPC			W48LAPQ	
	W48AAPQ				

***NOTE: LC6000 controller is required for operation when multiple MULTI-TEC wall-mount air conditioners are used.***



Climate Control Solutions

Bard Manufacturing Company, Inc.  
Bryan, Ohio 43506  
[www.bardhvac.com](http://www.bardhvac.com)

Manual : 2100-665G  
Supersedes: 2100-665F  
Date: 10-11-18

# CONTENTS

<b>General Information .....</b>	<b>3</b>
Free Cooling Unit System.....	3
Wall-Mount Air Conditioner Units.....	3
General .....	3
Shipping Damage.....	4
Additional Publications.....	4
<b>Using the TEC-EYE™ .....</b>	<b>6</b>
TEC-EYE Hand-Held Diagnostic Tool .....	6
TEC-EYE Menu Structure.....	7
TEC-EYE Acronyms .....	7
Status Screen.....	7
Quick Menu.....	8
Setpoints .....	8
Information .....	8
Data (Alarm) Log.....	8
Menu Screens and Password Levels.....	9
Addressing Wall-Mount Units .....	9
Setting Unit Zone .....	9
Additional Features .....	9
Model/Serial Number Retain Feature ..	9
Time/Date/Timezone Sync .....	9
Executing a Run Test.....	9
Parameter Description .....	10
Changing Free Cooling Type .....	10
<b>Alarms.....</b>	<b>11</b>
Acknowledging/Clearing Alarms.....	11
Clearing Alarms .....	11
Clearing Alarm Logs .....	12
Alarm Adjustment.....	12
Mixed Air Alarm.....	12
Refrigerant Low Pressure .....	12
Refrigerant High Pressure .....	13
Economizer Damper .....	13
Freezestat .....	13
<b>Control Operation .....</b>	<b>14</b>
On/Off Control .....	14
Fan Control .....	14

## FIGURES AND TABLES

Figure 1	MULTI-TEC Wall-Mount Unit Model Nomenclature .....	3
Figure 2	TEC-EYE Display and Interface .....	6
Figure 3	TEC-EYE Connection to Unit Control .....	6
Figure 4	Quick Menu Icons.....	7
Figure 5	Cooling and Heating Setpoints.....	8
Figure 6	Last 24 Hour Tracking.....	8
Figure 7	Last 24 Hour Tracking.....	8
Figure 8	Software Version Information .....	8
Figure 9	Alarm Log Screen Breakdown .....	8
Figure 10	Unit Configuration .....	9
Figure 11	Executing Run Test.....	9
Figure 12	Alarm Screen Breakdown.....	11
Figure 13	Clearing Alarms.....	11
Figure 14	Clearing Alarm Logs.....	12
Figure 15	Adjusting Mixed Air Alarm Values.....	12
Figure 16	Adjusting Damper Alarm Values .....	13
Figure 17	Adjusting Freeze Alarm Values .....	13

Temperature Control.....	14	
Cooling Sequence – Economizer Available ..	14	
Cooling Sequence – Economizer Not Available .....	14	
Heating Sequence.....	15	
Free Cooling.....	16	
Economizer Disable.....	16	
Economizer Enable .....	16	
None .....	16	
Drybulb Only .....	16	
Temperature and Humidity (Default) ..	16	
Enthalpy .....	16	
Economizer Modulation .....	16	
Compressor .....	17	
Enable.....	17	
Delays and Run Time.....	17	
Electric Reheat Dehumidification .....	17	
Mechanical Dehumidification .....	18	
<b>General Refrigerant Information.....</b>	<b>19</b>	
General .....	19	
Topping Off System Charge.....	19	
Safety Practices.....	19	
R410A Refrigerant Charge.....	19	
<b>Componentry .....</b>	<b>21</b>	
High Pressure Switch .....	21	
Three Phase Scroll Compressor Start Up Information .....	21	
Phase Monitor .....	21	
Condenser Fan Operation.....	21	
Low Ambient Control.....	21	
Compressor Control Module .....	22	
Pressure Service Ports.....	23	
Outdoor Fan Motor .....	23	
<b>Maintenance and Troubleshooting .....</b>	<b>26</b>	
Standard Maintenance Procedures .....	26	
Removal of Fan Shroud .....	26	
Troubleshooting Nidec SelecTech ECM Motors ..	27	
Figure 18	Wall-Mount Unit Cooling Staging.....	14
Figure 19	Adjusting Cooling Differential Values .....	15
Figure 20	Adjusting Heating Differential Values.....	15
Figure 21	Wall-Mount Unit Heating Staging .....	15
Figure 22	Economizer A4 Screen .....	16
Figure 23	Economizer A5 Screen .....	16
Figure 24	Adjusting Damper Modulation Value .....	17
Figure 25	Dehumidification Control.....	17
Figure 26	Wall-Mount Unit Control Board .....	18
Figure 27	8201-164 Compressor Control Module...22	
Figure 28	Fan Blade Setting.....	23
Figure 29	Motor Connections.....	27
Figure 30	Motor Connections.....	28
Table 1	Wall-Mount Unit Status Messages .....	7
Table 2	LC1000/TEC-EYE Passwords (Defaults) ....	9
Table 3	Wall-Mount Unit Alarm Index.....	11
Table 4	Cooling Pressures .....	20
Table 5A	Optional Accessories – Right Hand.....	24
Table 5B	Optional Accessories – Left Hand.....	25

# GENERAL INFORMATION

## Free Cooling System

The Bard free cooling unit system is composed of MULTI-TEC wall-mounted air conditioners matched with an LC6000 supervisory controller or Bard th-Tune stand-alone controller. If only one wall-mounted air conditioner is being used, it can be matched with either the LC6000 supervisory controller or a th-Tune stand-alone controller. If more than one wall-mount unit is installed, the LC6000 controller must be matched with the air conditioning units. The wall mounts are specifically engineered for telecom/motor control center rooms.

**NOTE:** *The LC6000 supervisory controller and MULTI-TEC wall-mount units are designed specifically to work together. The controller cannot run other brands of systems, nor can other controllers run the MULTI-TEC wall-mount units. They are a complete system, and must be used together.*

## Wall-Mount Air Conditioner Units

The MULTI-TEC units are designed to supply full rated cooling airflow in free cooling mode with ability to exhaust the same amount through the unit itself without any additional relief openings in the shelter. In the event that free cooling operation cannot satisfy the load requirements, mechanical cooling will be utilized to assist in cooling the shelter.

MULTI-TEC units are available with electric heat and dehumidification options.

## General

The equipment covered in this manual is to be installed by trained, experienced service and installation technicians.

The refrigerant system is completely assembled and charged. All internal wiring is complete.

The unit is designed for use with or without duct work. Flanges are provided for attaching the supply and return ducts.

These instructions explain the recommended method to install the air cooled self-contained unit and the electrical wiring connections to the unit.

These instructions and any instructions packaged with any separate equipment required to make up the entire air conditioning system should be carefully read before beginning the installation. Note particularly any tags and/or labels attached to the equipment.

While these instructions are intended as a general recommended guide, they do not supersede any national and/or local codes in any way. Authorities having jurisdiction should be consulted before the installation is made. See **ADDITIONAL PUBLICATIONS** on page 4 for information on codes and standards.

**FIGURE 1**  
**MULTI-TEC Wall-Mount Unit Model Nomenclature**

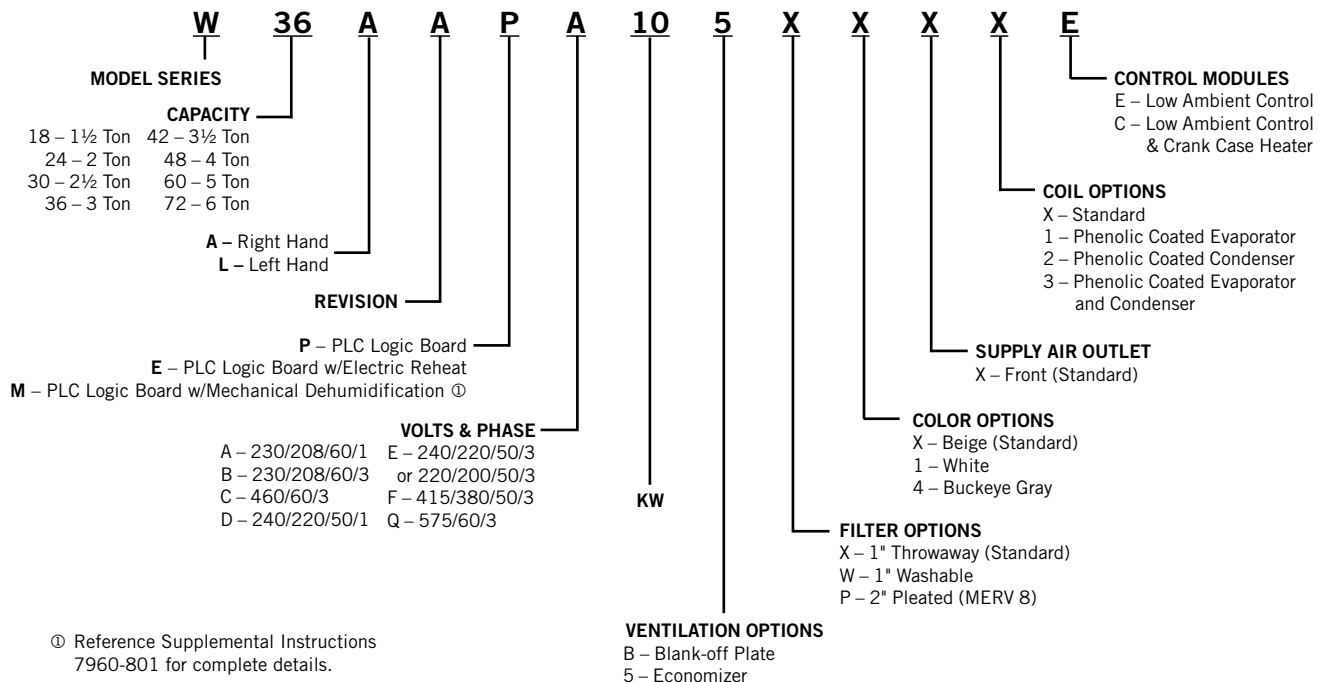

Sizing of systems for proposed installation should be based on heat loss and heat gain calculations made according to methods of Air Conditioning Contractors of America (ACCA). The air duct should be installed in accordance with the *Standards of the National Fire Protection Association for the Installation of Air Conditioning and Ventilating Systems of Other Than Residence Type, NFPA No. 90A*, and *Residence Type Warm Air Heating and Air Conditioning Systems, NFPA No. 90B*. Where local regulations are at a variance with instructions, installer should adhere to local codes.

### Shipping Damage

Upon receipt of equipment, the cartons should be checked for external signs of shipping damage. If damage is found, the receiving party must contact the last carrier immediately, preferably in writing, requesting inspection by the carrier's agent.

These units must remain in upright position at all times.

### Additional Publications

These publications can help when installing the furnace. They can usually be found at the local library or purchased directly from the publisher. Be sure to consult the current edition of each standard.

- National Electrical Code .....ANSI/NFPA 70
- Standard for the Installation of Air Conditioning and Ventilating Systems .....ANSI/NFPA 90A
- Standard for Warm Air Heating and Air Conditioning Systems .....ANSI/NFPA 90B
- Load Calculation for Residential Winter and Summer Air Conditioning ..... ACCA Manual J
- Duct Design for Residential Winter and Summer Air Conditioning and Equipment Selection ..... ACCA Manual D

For more information, contact these publishers:

**Air Conditioning Contractors of America (ACCA)**  
1712 New Hampshire Ave. N.W.  
Washington, DC 20009  
Telephone: (202) 483-9370 Fax: (202) 234-4721

**American National Standards Institute (ANSI)**  
11 West Street, 13th Floor  
New York, NY 10036  
Telephone: (212) 642-4900 Fax: (212) 302-1286

**American Society of Heating, Refrigeration and Air Conditioning Engineers, Inc. (ASHRAE)**  
1791 Tullie Circle, N.E.  
Atlanta, GA 30329-2305  
Telephone: (404) 636-8400 Fax: (404) 321-5478

**National Fire Protection Association (NFPA)**  
Batterymarch Park  
P. O. Box 9101  
Quincy, MA 02269-9901  
Telephone: (800) 344-3555 Fax: (617) 984-7057

### ANSI Z535.5 Definitions:

**DANGER:** Indicate[s] a hazardous situation which, if not avoided, will result in death or serious injury. The signal word "DANGER" is to be limited to the most extreme situations. DANGER [signs] should not be used for property damage hazards unless personal injury risk appropriate to these levels is also involved.

**WARNING:** Indicate[s] a hazardous situation which, if not avoided, could result in death or serious injury. WARNING [signs] should not be used for property damage hazards unless personal injury risk appropriate to this level is also involved.

**CAUTION:** Indicate[s] a hazardous situation which, if not avoided, could result in minor or moderate injury. CAUTION [signs] without a safety alert symbol may be used to alert against unsafe practices that can result in property damage only.

**NOTICE:** [this header is] preferred to address practices not related to personal injury. The safety alert symbol shall not be used with this signal word. As an alternative to "NOTICE" the word "CAUTION" without the safety alert symbol may be used to indicate a message not related to personal injury.



## **WARNING**

***Electrical shock hazard.***

***Have a properly trained individual perform these tasks.***

***Failure to do so could result in electric shock or death.***

## **WARNING**

***Fire hazard.***

***Maintain minimum 1/4" clearance between the supply air duct and combustible materials in the first 3' feet of ducting.***

***Failure to do so could result in fire causing damage, injury or death.***

## **WARNING**

***Heavy item hazard.***

***Use more than one person to handle unit.***

***Failure to do so could result in unit damage or serious injury.***

## **CAUTION**

***Cut hazard.***

***Wear gloves to avoid contact with sharp edges.***

***Failure to do so could result in personal injury.***

# USING THE TEC-EYE™

**FIGURE 2**  
TEC-EYE (Bard P/N 8301-059) Display and Interface (Status Screen Shown)



**ALARM KEY**

Allows viewing of active alarms  
Silences audible alarms  
Resets active alarms

**MENU KEY**

Allows entry to Main Menu

**ESCAPE KEY**

Returns to previous menu level  
Cancels a changed entry

**UP KEY**

Steps to next screen in the display menu  
Changes (increases) the value of a modifiable field

**ENTER KEY**

Accepts current value of a modifiable field  
Advances cursor

**DOWN KEY**

Steps back to previous screen in the display menu  
Changes (decreases) the value of a modifiable field

## TEC-EYE Hand-Held Diagnostic Tool

The microprocessor control used in the MULTI-TEC wall-mount air conditioners allows for complete control and monitoring through the use of the provided TEC-EYE hand-held monitor. This comprehensive service tool utilizes the latest in state-of-the-art technology including a large, easy-to-read backlit LCD graphic display.

The menu driven interface provides users the ability to scroll through two menu levels: Quick Menu and Main Menu. The menus permit the user to easily view, control and configure the unit.

The controller is completely programmed at the factory; the default setpoints and their ranges are easily viewed and adjusted from the TEC-EYE display. The program and operating parameters are permanently stored on FLASH-MEMORY in case of power failure. The controller is designed to manage temperature levels to a user-defined setpoint via control output signals to the wall mount air conditioning system.

The TEC-EYE connects to the wall-mount unit control board via an RJ11 modular phone connector as shown in Figure 3.

**FIGURE 3**  
TEC-EYE Connection to Unit Control

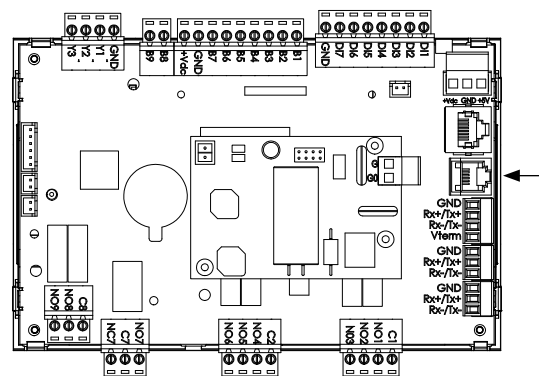

Modular Phone Connector for  
TEC-EYE Hand-Held Diagnostic Tool

When not being used, the TEC-EYE hand-held diagnostic tool should be stored inside or near the LC6000 controller. Do not let the TEC-EYE leave the shelter.

## TEC-EYE Menu Structure

### Quick Menu

- Data Log
- Unit Information
- Setpoints

### Main Menu

- System Configuration
- Advanced System Configuration
- I/O Configuration
- On/Off
- Alarm Logs
- Settings
- Logout

In addition to the menu structure above, there are also Status and Alarm screens.

## TEC-EYE Acronyms

MAT – Mixed air temperature  
 RAT – Return air temperature  
 OAT – Outdoor air temperature  
 OAH – Outdoor air humidity  
 Blower – Indoor Blower Status  
 Damper – Free cooling damper position status  
 C1 – Compressor activate status  
 H1 – Heater Stage 1 status  
 H2 – Heater Stage 2 status  
 ODP – Calculated outdoor dew point  
 FC – Free cooling status  
 RN – Component run time in minutes in last hour  
 ST – Number of start requests in last hour

## Status Screen

The Status screen is the default start-up screen and also the return screen after 5 minutes of no activity. The screen can be accessed any time by pressing the ESCAPE button repeatedly.

The wall-mount unit address is displayed in the upper right corner on the Status screen (see Figure 2). The Status screen also shows the current date, time, return air temperature, mixed air temperature, outdoor air temperature, outdoor humidity and outdoor dewpoint conditions. Blower, damper and unit status are also displayed. See Table 1 for MULTI-TEC wall-mount unit status messages.

The Quick Menu is displayed in the bottom right corner of the status screen (see Figure 2). Data Log, Unit Information and Setpoints are available through the Quick Menu. Pressing the UP or DOWN keys while on the Status screen will change the Quick Menu icon displayed (see Figure 4). Press the ENTER key when the desired icon is displayed.

**TABLE 1**  
**Wall-Mount Unit Status Messages**

Message	Description
Stand Alone	Orphan Mode Standby
th-TUNE Online	th-TUNE Standby
LC Online	LC Standby
Cont. Blower	Continuous Blower Active
Off by th-TUNE	Unit off by th-TUNE
Freecooling	Freecooling Active
Optimized Cool	Optimized Cooling Active
Cooling	Cooling Active
Heating	Heating Active
Active Dehum	Mechanical Dehumidification or Electric Reheat Dehumidification Active
Passive Dehum	Economizer Disable/Enhanced Latent Removal (if available)
Self Test	Self Test Running
Off by Alarm	Unit Off by Alarm Condition
Off by BMS	Unit Off by BMS
Off by LC	Unit Off by LC Master
Off by Keypad	Unit Off by Keypad
Emergency Vent.	Emergency Vent Mode Active
Emergency Cool	Emergency Cool Mode Active
Emergency Off	Emergency Off Mode Active

**FIGURE 4**  
**Quick Menu Icons**



# NOTICE

***It is important to check the software version during installation to ensure that the latest version has been installed. Current software versions, change log and installation instructions are available on the Bard website at <http://www.bardhvac.com/software-download/>***

**Quick Menu**

**Setpoints**

If at any time the unit(s) loses communication with the LC6000 controller, the unit(s) will go to stand alone mode. The setpoints are synced with the LC6000 when communication is established. The unit will save and control to these values until communication is re-established.

To change the cooling and heating setpoints:

1. From the Status screen, press UP or DOWN key until Quick Menu displays Setpoints icon. Press ENTER key.
2. Press ENTER key to scroll to the selected choice (see Figure 5).
3. Press UP or DOWN key on desired value until value displays correctly.
4. Press ENTER key to submit value and move to next parameter.
5. Press ESCAPE key until Main Menu screen is displayed.

**FIGURE 5**  
Cooling and Heating Setpoints

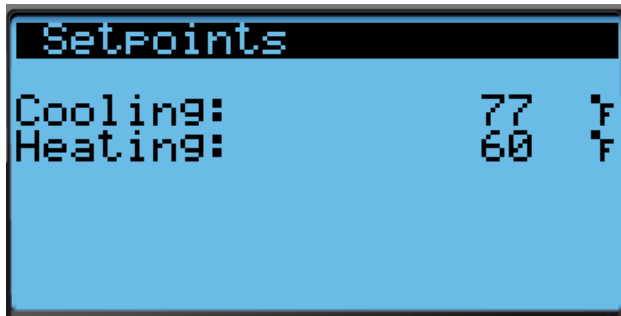

**Information**

These screens show unit run hours, averages and software version information (see Figures 6, 7 and 8).

**FIGURE 6**  
Last 24 Hour Tracking

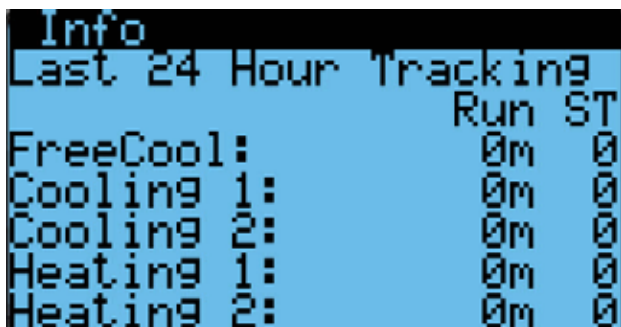

**FIGURE 7**  
Last 24 Hour Tracking

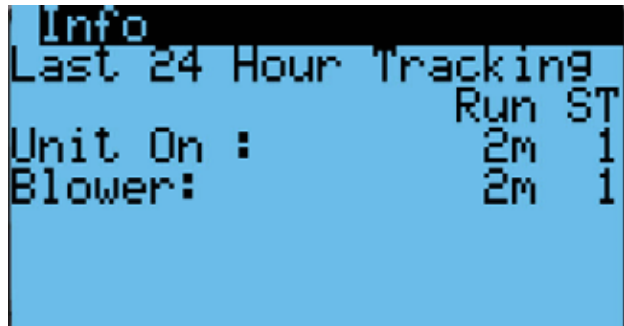

**FIGURE 8**  
Software Version Information

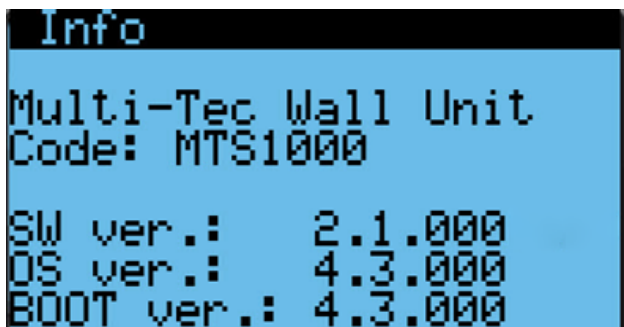

**Data (Alarm) Log**

The alarm log screens show a log of each alarm (see Figure 9). There will be a log for when alarm occurred and if the alarm auto clears, it will show when the alarm cleared. See page 12 for instructions on clearing the alarm logs.

**FIGURE 9**  
Alarm Log Screen Breakdown



**NOTE**  
Screenshots shown in this manual reflect default settings (when applicable).



**TABLE 2**  
**LC1000/TEC-EYE Passwords (Defaults)**

User	2000
Technician	1313
Engineer	9254
Use UP or DOWN keys and ENTER key to enter password	

### Menu Screens and Password Levels

- A** System Config: User (2000)
- B** Adv Sys Config: Technician (1313)
- C** I-O Config: Technician (1313)
- D** On/Off: User (2000)
- E** Alarm Logs: User (2000)
- F** Settings
  - Date/Time: Technician (1313)
  - Language: User (2000)
  - Network Config: Technician (1313)
  - Serial Ports: Technician (1313)
  - Initialization
    - Clear Logs: User (2000)
    - System Default: Engineer (9254)
    - Restart: User (2000)
    - Parameter Config: Engineer (9254)
    - Alarm Export: User (2000)
- G** Logout: Used to log out of the current password level. Entering back into the menu requires password.

### Addressing Wall-Mount Units

Each unit must have a unique address for the system to operate correctly with the LC controller (*Ex: 1, 2, 3, ...14 depending on the number of units*). The wall-mount unit address is displayed in the upper right corner on the Status screen on the TEC-EYE display (see Figure 2 on page 6).

To change the unit address:

1. Press MENU key to access the Main Menu screen.
2. Press UP or DOWN keys and ENTER key to enter USER password 2000.
3. Press UP or DOWN keys to scroll to **Sys Config**; press ENTER key.
4. Press ENTER key to scroll to **Unit Address** (see Figure 10).
5. Press UP or DOWN keys to change the address to a value between 1 and 14.

**NOTE:** Each unit must have a unique address for the communication to work properly. Bard also recommends physically labeling each unit for ease in identification.

**FIGURE 10**  
**Unit Configuration**

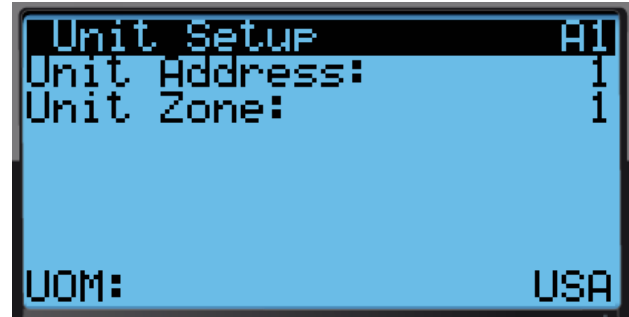

### Setting Unit Zone

To assign zones:

1. Press MENU key to access the Main Menu screen.
2. Press UP or DOWN keys and ENTER key to enter USER password 2000.
3. Press UP or DOWN keys to scroll to **Sys Config**; press ENTER key.
4. Press ENTER key to scroll to **Unit Zone** (see Figure 10).
5. Press UP or DOWN keys to change value to desired zone.

### Additional Features

#### Model/Serial Number Retain Feature

Model numbers and serial numbers will be retained through most software updates. It still remains good practice to verify the software version, model numbers and serial numbers of any wall-mount unit after a software update, as some functionality of the MULTI-TEC wall-mount unit require a specific model number.

#### Time/Date/Timezone Sync

On MULTI-TEC wall-mount unit models with a software version number MTS1000.2.0.0 and higher, when the wall-mount unit is connected and correctly addressed to a LC6000 supervisory controller, local time, date, and timezone information will be synced from the LC6000. This feature allows for faster set-up and correct correlation between alarm logs.

### Executing a Run Test

Execute a run test on each unit to verify the equipment is functioning correctly.

1. Press MENU key to access the Main Menu screen.
2. Press UP or DOWN keys and ENTER key to enter USER password 2000.

3. Press UP or DOWN keys to scroll to **Sys Config**; press ENTER key.
4. Press UP or DOWN keys to scroll to **Run Test (A11)** screen.
5. Press ENTER key to scroll to **Run Test Enable** parameter (see Figure 11).
6. Press UP or DOWN key to change value to ON. The run test will begin.

**FIGURE 11**  
**Executing Run Test**

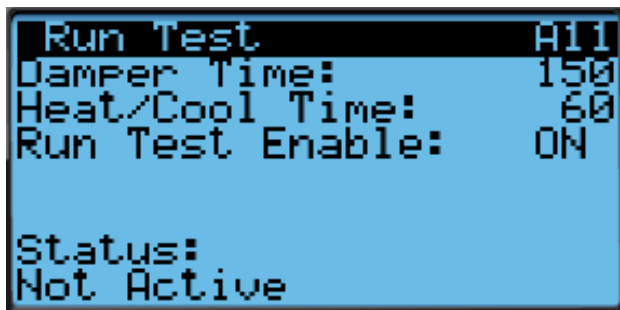

Step	Action	Time Required
A	Open economizer damper	Damper Time (150s)
B	Close economizer Damper	Damper Time (150s)
C	Turn on compressor	Heat/Cool Time (60s)
D	Enable second stage	Heat/Cool Time (60s)
E	Open reheat valve	Heat/Cool Time (60s)
F	Turn all cooling off	--
G	Turn on electric heat	Heat/Cool Time (60s)
H	Turn on electric heat stage 2	Heat/Cool Time (60s)
I	Turn off all heating	--

#### **Parameter Description**

**Damper Time:** This is the time (in seconds) allowed for both the opening sequence and closing sequence.

**Heat/Cool Time:** This is the time (in seconds) allowed for cooling sequence and heating sequence.

**Status:** This will display what the unit is doing as the run test progresses. The following messages may appear:

1. Not Active
2. Opening Damper
3. Closing Damper
4. Compressor Stage 1
5. Compressor Stage 2
6. Reheat Valve Open
7. Cooling Off

8. Electric Heat Stage 1
9. Electric Heat Stage 2
10. Heating Off
11. Run Test Stop

The unit will determine which items to test based on the unit model number.

#### **Identifying a Unit Address**

The wall-mount unit address is displayed in the upper right corner on the Status screen.

#### **Changing Freecooling Type**

The comparative enthalpy free cooling setting can be changed to dry bulb free cooling using the TEC-EYE hand-held diagnostic tool.

1. Press MENU key to access the Main Menu screen.
2. Press UP or DOWN keys and ENTER key to enter USER password 2000.
3. Press UP or DOWN keys to scroll to **Sys Config**; press ENTER key.
4. Press UP or DOWN keys to scroll to screen with **Freecooling Config** heading.
5. Press ENTER key to scroll to parameter type.
6. Press UP or DOWN keys to change to desired value.
7. Press ENTER key to save.
8. Press ESCAPE key until Main Menu screen is displayed.

**NOTE:** Screenshots shown in this manual reflect default settings (when applicable).

## Acknowledging/Clearing Alarms

Alarm conditions activate a red LED indicator that backlights the ALARM function key. As an option, an alarm condition may also be enunciated by an audible alarm signal. An alarm is acknowledged by pressing the ALARM key. This calls up alarm display screen(s) that provide a text message detailing the alarm condition(s)—as shown in Figure 12.

**FIGURE 12**  
Alarm Screen Breakdown

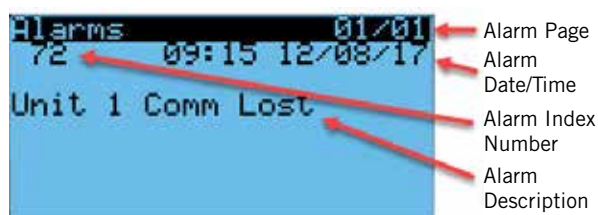

## Clearing Alarms

After an alarm condition has been corrected, the alarm can be cleared/reset.

To clear alarms, press the ALARM key and the UP or DOWN keys to scroll to the alarm reset screen (see Figure 13). Hold down the ALARM key for 3 seconds until the screen flashes. After the screen flashes, if all alarms are able to be cleared, the screen should read NO ALARMS. If there are still active alarms, the screen will show the first indexed alarm.

**FIGURE 13**  
Clearing Alarms

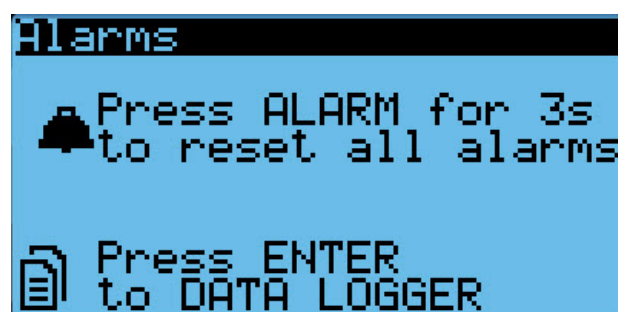

**TABLE 3**  
Wall-Mount Unit Alarm Index

Index	Alarm Log Export Variable	PGD Displayed Alarm Description
0	AI_retain	Error in the number of retain memory writings
1	AI_Err_retain_write	Error in retain memory writings
2	AI_ReturnAir1In	Circuit 1 Return Air Temperature Sensor Alarm
3	AI_ReturnAir1High	Circuit 1 High Return Air Temperature
6	AI_MixedAir1In	Circuit 1 Mixed Air Temperature Sensor Alarm
7	AI_MixedAir1High	Circuit 1 Mixed Air High Temperature
8	AI_MixedAir1Low	Circuit 1 Mixed Air Low Temperature
18	AI_OutdoorAirIn	Outdoor Air Temperature Sensor Alarm
19	AI_OutdoorHumIn	Outdoor Air Humidity Sensor Alarm
36	AI_LowPress1	Circuit 1 Low Pressure
38	AI_HighPress1	Circuit 1 High Pressure
40	AI_Damper1FailedtoOpen	Circuit 1 Damper Failed to Open
41	AI_Damper1FailedtoClose	Circuit 1 Damper Failed to Close
48	AI_Freeze1In	Circuit 1 Freeze Temperature Sensor Alarm
50	AI_Freeze1	Circuit 1 Freeze Condition
54	AI_Filter1	Filter 1 Dirty Filter Indicated
92	AI_Offline_THTN_1	Th-Tune Device Offline
93	AI_TempPrb_THTN_1	Th-Tune Temperature Probe Sensor Alarm
94	AI_HumPrb_THTN_1	Th-Tune Humidity Probe Sensor Alarm
95	AI_ClkBrd_THTN_1	Th-Tune Clock Board Alarm

## Clearing Alarm Logs

To clear the alarm logs:

1. Press MENU key to go to the Main Menu screen.
2. Press UP or DOWN keys and ENTER key to enter TECHNICIAN password 1313.
3. Press UP or DOWN keys to scroll to **Settings**; press ENTER key.
4. Press UP or DOWN keys to scroll to **Initialization**; press ENTER key.
5. Press UP or DOWN keys to scroll to **Initialization 1/5**; press ENTER key.
6. Press ENTER key to scroll to **Delete alarm logs?** (see Figure 14).
7. Press UP or DOWN key to change from **NO** to **YES**.
8. Press ENTER key to clear all alarm logs.

**FIGURE 14**  
Clearing Alarm Logs

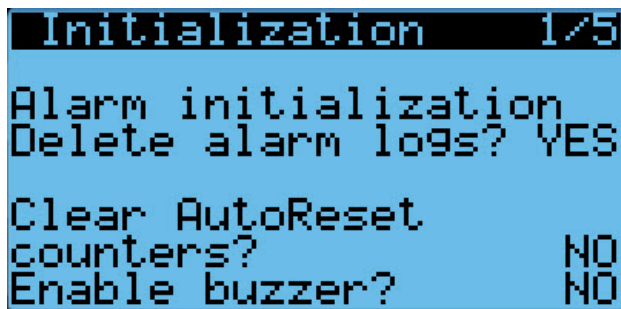

## Alarm Adjustment

### Mixed Air Alarm

The mixed air alarm is used to indicate proper operation of the economizer. An alarm will be generated when the mixed air temperature is above or below two independent setpoints.

This alarm can be adjusted by changing the alarm setpoints and/or delay. The differential low references the economizer control setpoint. For example, if the economizer setpoint is 55°F (as shown in Figure 24 on page 17) and the differential is set to 10, the lower limit for the mixed air alarm would be 45°F. The high differential references the outdoor air temperature setpoint that enables the economizer. For example, if the outdoor air temperature setpoint for economizer enable is set to 65°F and the high alarm is set to 5, the alarm would actuate at 70°F. The alarm also has a delay to help reduce nuisance alarms. With the delay set to 120 seconds, either the high mixed air or low mixed air alarm will need to be active for 120 seconds before an alarm will be generated.

To adjust these values:

1. Press MENU key to go to the Main Menu screen.
2. Press UP or DOWN keys and ENTER key to enter USER password 2000.
3. Press UP or DOWN keys to scroll to **Sys Config**; press ENTER key.
4. Press UP or DOWN keys to scroll to **Alarm Config (A7)**; press ENTER key.
5. Press ENTER key to scroll to desired value **Diff Lo**, **Diff Hi** or **Del** (see Figure 15).
6. Press UP or DOWN keys to adjust value.
7. Press ENTER key to save.

**FIGURE 15**  
Adjusting Mixed Air Alarm Values

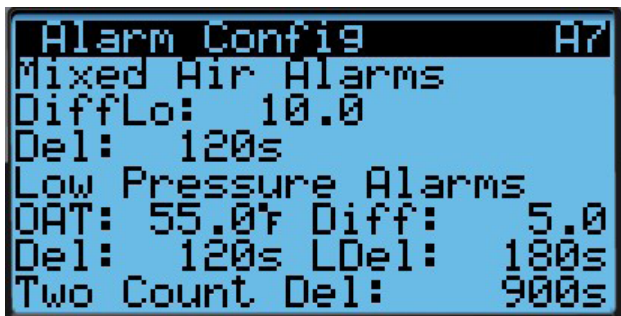

### Refrigerant Low Pressure

When the low pressure switch indicates a low pressure condition and there is an active call for cooling, the controller will generate an alarm (after a delay). The delay used by the low pressure alarm is determined by the outdoor air temperature (OAT on display). If the outdoor air temperature is below 55°F, the delay is 180 seconds (LDel on display). If the outdoor temperature is above 55°F, the delay is 120 seconds (Del on display). The unit will also have an address-based delay that will affect start up time; the default is 5 seconds multiplied by unit address. (The unit address-based delay is only when the unit is in stand alone operation.) Additionally, if the outdoor temperature sensor is not used, the delay is set to 180 seconds. The controller will try to run the refrigeration system two times before the alarm will lock the compressor out.

If 15 minutes (Two Count Del value on display) passes before the second attempt, the number of tries will be reset.

To adjust these values:

1. Press MENU key to go to the Main Menu screen.
2. Press UP or DOWN keys and ENTER key to enter USER password 2000.
3. Press UP or DOWN keys to scroll to **Sys Config**; press ENTER key.

4. Press UP or DOWN keys to scroll to **Alarm Config (A7)**; press ENTER key.
5. Press ENTER key to scroll to desired value **OAT, Diff, Del, LDel or Two Count Del** (see Figure 15).
6. Press UP or DOWN keys to adjust value.
7. Press ENTER key to save.

### Refrigerant High Pressure

When the wall-mount unit receives a signal from the compressor control module (CCM) indicating a high pressure event, the wall-mount unit will generate an alarm. Upon receiving the alarm, the wall-mount unit will remove the “Y” call from the CCM, resetting the status of the CCM. The alarm will stay present on the wall-mount unit until manually cleared. This operation has no configurable parameters.

### Economizer Damper

When the controller commands the economizer damper actuator to a position other than 0% and the damper switch indicates the damper is not open, after a delay of 20 seconds (Open Del on display) the controller will generate a damper failed to open alarm. When the controller commands the economizer damper actuator to the 0% position and the damper switch indicates the damper is not closed, after a delay of 300 seconds (Close Del on display) the controller will generate a damper failed to close alarm.

To adjust these values:

1. Press MENU key to go to the Main Menu screen.
2. Press UP or DOWN keys and ENTER key to enter USER password 2000.
3. Press UP or DOWN keys to scroll to **Sys Config**; press ENTER key.
4. Press UP or DOWN keys to scroll to **Alarm Config (A8)**; press ENTER key.
5. Press ENTER key to scroll to desired value **Open Del or Close Del** (see Figure 16).
6. Press UP or DOWN keys to adjust value.
7. Press ENTER key to save.

**FIGURE 16**  
Adjusting Damper Alarm Values

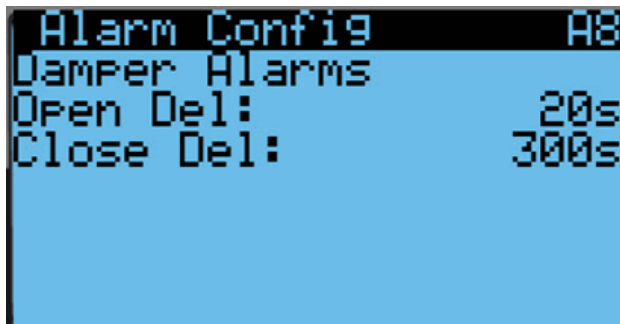

### Freezestat

When the coil temperature is below 30°F, the unit will generate a Freeze alarm on the TEC-EYE and a Freeze Temp alarm on the LC6000. This will operate the blower and turn off the compressor.

The alarm will be automatically reset when the coil temperature rises above 55°F or after a 5-minute delay while the temperature is above 30°F.

To adjust freezestat values:

1. Press MENU key to go to the Main Menu screen.
2. Press UP or DOWN keys and ENTER key to enter USER password 2000.
3. Press UP or DOWN keys to scroll to **Sys Config**; press ENTER key.
4. Press UP or DOWN keys to scroll to **Alarm Config (A9)**; press ENTER key.
5. Press ENTER key to scroll to desired value **Low Temp, Delay, Reset Temp or Reset Del** (see Figure 17).
6. Press UP or DOWN keys to adjust value.
7. Press ENTER key to save.

**FIGURE 17**  
Adjusting Freeze Alarm Values



# CONTROL OPERATION

**NOTE:** Screenshots shown in this manual reflect default settings (when applicable).

## On/Off Control

The wall-mount unit can be turned on and off with the TEC-EYE. When the unit is set to ON, the system will heat and cool the space either in standalone mode or when connected to the LC. When the unit is set to OFF, the unit will not heat or cool the space.

To turn the unit on or off:

1. Press MENU key to go to the Main Menu screen.
2. Press UP or DOWN keys and ENTER key to enter USER password 2000.
3. Press UP or DOWN keys to scroll to **ON/OFF**; press ENTER key.
4. Press UP or DOWN key to change the system from OFF to ON or from ON to OFF.
5. Press ESCAPE key until Main Menu screen is displayed.

## Fan Control

The blower will be in continuous operation in stand alone mode. To operate the blower continuously while communicating with the LC6000 or th-TUNE single unit controller, refer to the latest version of the 2100-669 LC6000 Service Instructions manual or 2100-678 th-TUNE manual.

## Temperature Control

When the unit is connected to the LC controller, it will receive all of its heating, cooling and ventilation commands from the controller.

When the unit is in stand alone operation, it will heat, cool and ventilate based on the return air temperature measurement. The return air temperature will be compared to the cooling setpoint. Based on differentials above and below the setpoint, the available cooling and heating stages will be utilized.

### Cooling Sequence – Economizer Available

(see Figure 18)

If the return air temperature is higher than 79°F (Setpoint + Stage 1 Diff On) and outdoor conditions are acceptable for economizing, the unit will enable the economizer. If the return air temperature is higher than 80°F (Setpoint + Stage 2 Diff On), the unit will enable mechanical cooling stage 1. If the control value is higher than 81°F (Setpoint + Stage 3 Diff On), the unit will enable mechanical cooling stage 2.

### Cooling Sequence – Economizer Not Available

(see Figure 18)

If the return air temperature is higher than 79°F (Setpoint + Stage 1 Diff On), the unit will enable stage 1 mechanical cooling. If the return air temperature is higher than 80°F (Setpoint + Stage 2 Diff On), the unit will enable stage 2 mechanical cooling.

**FIGURE 18**  
**MULTI-TEC Wall-Mount Unit Cooling Staging**

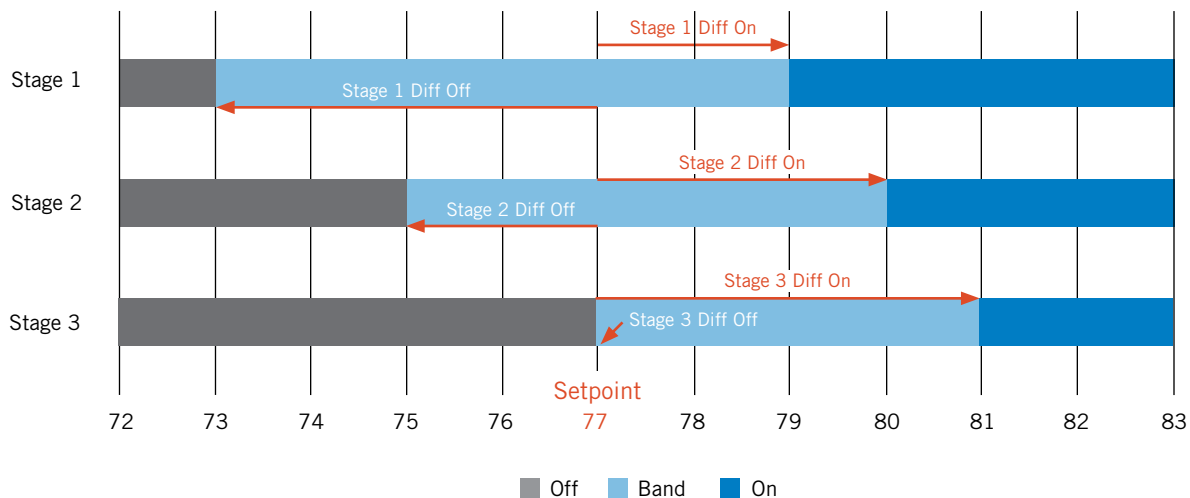



To adjust these parameters:

1. Press MENU key to go to the Main Menu screen.
2. Press UP or DOWN keys and ENTER key to enter USER password 2000.
3. Press UP or DOWN keys to scroll to **Sys Config**; press ENTER key.
4. Press UP or DOWN keys to scroll to **Cooling Setup (A2)**; press ENTER key.
5. Press ENTER key to scroll to **Stage 1 Diff On**, **Stage 1 Diff Off**, **Stage 2 Diff On**, **Stage 2 Diff Off**, **Stage 3 Diff On** or **Stage 3 Diff Off** (see Figure 19).
6. Press UP or DOWN keys to adjust value.
7. Press ENTER key to save.

**FIGURE 19**  
Adjusting Cooling Differential Values

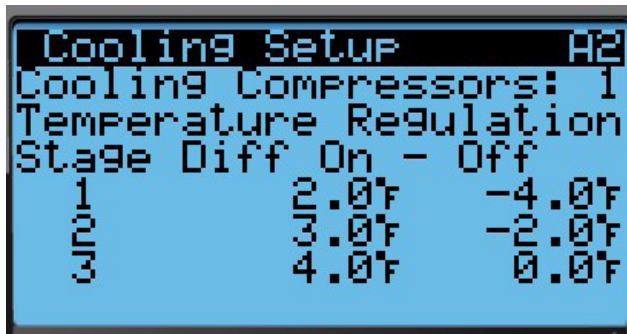

**Heating Sequence** (see Figure 21)

If the return air temperature is below 58°F (Setpoint + Stage 1 Diff On), the unit will enable electric heat stage 1. If the return air temperature is below 57°F (Setpoint + Stage 2 Diff On), the unit will enable

electric heat stage 2. If the control value is below 56°F (Setpoint + Stage 3 Diff On), the unit will enable electric heat stage 3.

To adjust these parameters:

1. Press MENU key to go to the Main Menu screen.
2. Press UP or DOWN keys and ENTER key to enter USER password 2000.
3. Press UP or DOWN keys to scroll to **Sys Config**; press ENTER key.
4. Press UP or DOWN keys to scroll to **Heating Setup (A3)**; press ENTER key.
5. Press ENTER key to scroll to **Stage 1 Diff On**, **Stage 1 Diff Off**, **Stage 2 Diff On**, **Stage 2 Diff Off**, **Stage 3 Diff On** or **Stage 3 Diff Off** (see Figure 20).
6. Press UP or DOWN keys to adjust value.
7. Press ENTER key to save.

**FIGURE 20**  
Adjusting Heating Differential Values

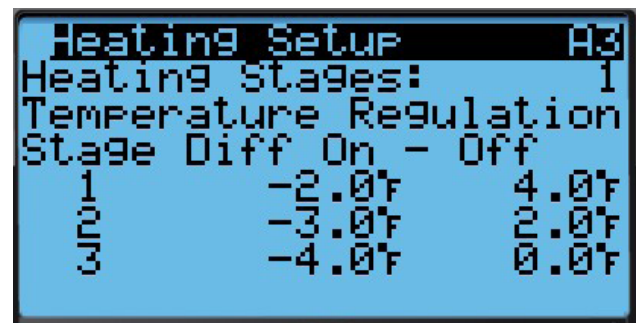

**FIGURE 21**  
MULTI-TEC Wall-Mount Unit Heating Staging

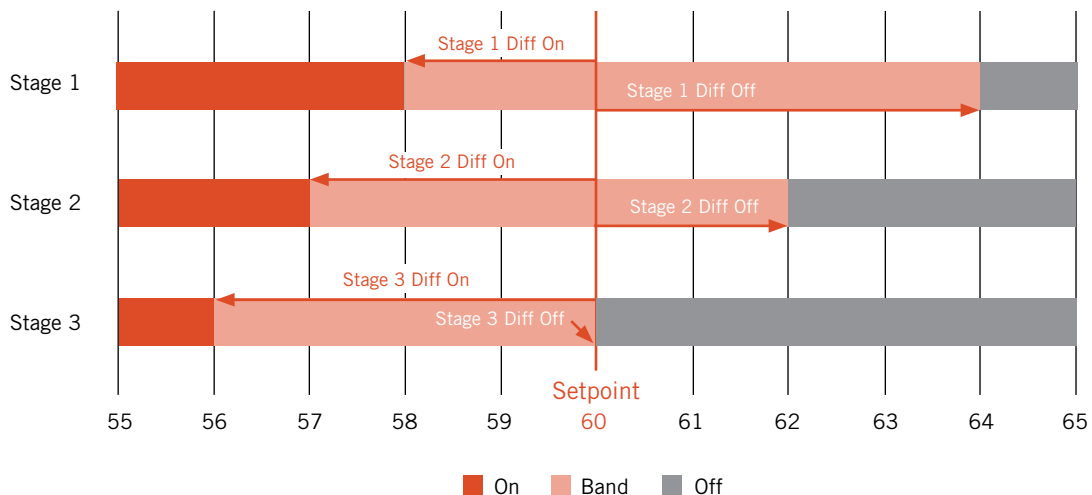

## Free Cooling

If the unit is equipped with an economizer, and conditions are acceptable for economizer operation, the MULTI-TEC wall-mount unit will utilize free cooling operation before the use of any cooling operation requiring compressor operation to reduce the energy required to cool the indoor space.

### Economizer Disable

There are two methods to disable the economizer if the use of free cooling is restricted. The first method is to select None as the economizer type within the **Sys. Config.** menu. The second method requires changing the model number within the **Adv. Sys. Config.** menu to reflect a model installed with a blank-off plate (see model nomenclature in Figure 1 on page 3). Changing the wall-mount unit model number to reflect a unit with a blank-off plate will not allow for an economizer type to be selected therefore defaulting to a disabled state, along with all sensors/alarms associated with it.

### Economizer Enable

The economizer will be enabled for cooling operation if the model number reflects a wall-mount unit with an economizer installed, an economizer type other than None and the conditions for the economizer type are met. The following list explains the economizer types and the parameters required for operation:

#### None

Economizer will not be enabled for freecooling operation.

#### Drybulb Only

1. Outdoor air temperature is below the Outdoor Set outdoor temperature setpoint listed within the **Sys. Config.** menu. (Outdoor Set temperature setpoint is 70°F by default.) See Figure 22.
2. LC6000 is not currently in any dehumidification mode.
3. LC6000 is not currently in any emergency mode.

#### Temperature and Humidity (Default)

1. Outdoor air temperature is below the Outdoor Set outdoor temperature setpoint listed within the **Sys. Config.** menu. (Outdoor Set temperature setpoint is 70°F by default.) See Figure 22.
2. Outdoor relative humidity is below the OA Humid Set outdoor humidity setpoint listed within the **Sys. Config.** menu. (OA Humid Set humidity setpoint is 80% RH by default.) See Figure 22.
3. LC6000 is not currently in any dehumidification mode.
4. LC6000 is not currently in any emergency mode.

## Enthalpy

1. Outdoor air temperature is below the Outdoor Set, outdoor temperature setpoint, listed within the **Sys. Config.** menu. (Outdoor Set temperature setpoint is 70°F by default.) See Figure 22.
2. Outdoor relative humidity is below the OA Humid Set outdoor humidity setpoint listed within the **Sys. Config.** menu. (OA Humid Set humidity setpoint is 80% RH by default.) See Figure 22.
3. The outdoor air dewpoint is below the OA Dew Pt Set outdoor dewpoint setpoint, listed within the **Sys. Config.** menu. (OA Dew Pt Set dewpoint setpoint is 55°F by default.) See Figure 23.
4. LC6000 is not currently in any dehumidification mode.
5. LC6000 is not currently in any emergency mode.

FIGURE 22  
Economizer A4 Screen

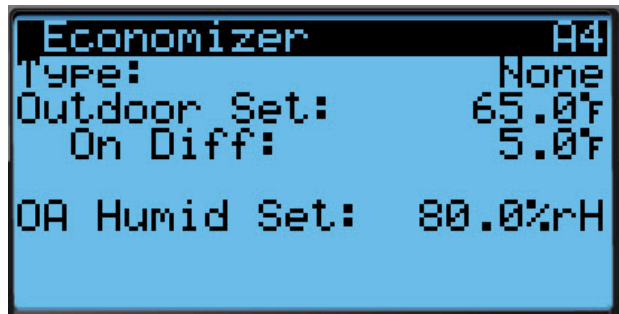
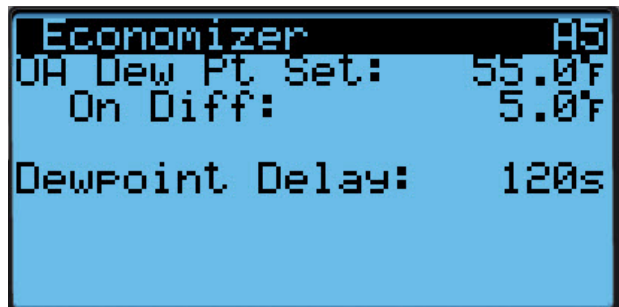

FIGURE 23  
Economizer A5 Screen



## Economizer Modulation

The economizer damper output will modulate between 0% and 100% to maintain a 55°F mixed air temperature when the outdoor air conditions are acceptable.

To adjust damper modulation values:

1. Press MENU key to go to the Main Menu screen.
2. Press UP or DOWN keys and ENTER key to enter USER password 2000.



3. Press UP or DOWN keys to scroll to **Sys Config**; press ENTER key.
4. Press UP or DOWN keys to scroll to **Unit Config (A6)**; press ENTER key.
5. Press ENTER key to scroll to **Mixed FC Set, Gain, Integral** or **Derivative** (see Figure 24).
6. Press UP or DOWN keys to adjust parameter value.
7. Press ENTER key to save.

**FIGURE 24**  
Adjusting Damper Modulation Values

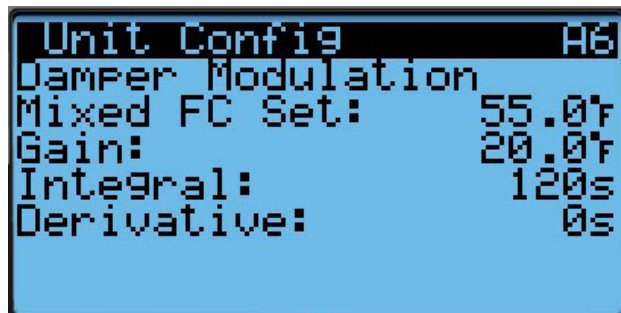

**Economizer Note**

The economizer and mechanical cooling can operate simultaneously because the economizer uses the mixed air temperature sensor.

**Compressor**

**Enable**

The compressor will be enabled when stage 1 is enabled and outdoor air conditions are not acceptable for economizing. If the outdoor conditions are acceptable, the compressor will run when stage 2 is enabled.

**Delays and Run Time**

The compressor will have a minimum run time of 180 seconds and a minimum off time of 120 seconds. If the compressor is two stage, the second stage will

have a minimum delay of 120 seconds. The 2nd stage will also have a minimum on time of 120 seconds. When communicating with the LC, the delay between compressors in units installed on the same shelter will be managed by the settings configured in the LC.

**Electric Reheat Dehumidification**

Electric reheat dehumidification is only available as a factory-installed option that must be ordered with the unit. It cannot be installed in the field on an existing unit.

Dehumidification will only become active if the unit is connected to the LC6000 and the appropriate conditions are present.

When the wall-mount unit receives a dehumidification call from the LC6000, the wall-mount unit will disable the economizer to force the system to use air conditioning and prevent any additional humidity from being introduced from outdoor air. The wall-mount unit will then turn on the air conditioning system which will remove moisture and cool the space. At the same time, the electric reheat coil will be energized to extend the run time of the cooling cycle and prevent cool air from being introduced to the space.

When the dehumidification command is first received both cooling and reheat will be activated.

The cooling will shut off when the return air temperature is 62°F to prevent the unit from causing the system to go into heating mode (see Figure 25). The compressor will turn on again once the return temperature rises to 75°F.

The electric heat will operate to maximize cooling times which will in turn remove moisture from the space. The electric reheat will turn on when the temperature falls to 73°F and will turn back off at 75°F.

The system will continue to operate this way until the LC removes the call for active dehumidification.

A heating or cooling call will disable the dehumidification call. Dehumidification can only take place when system is not actively heating or cooling.

**FIGURE 25**  
Dehumidification Control

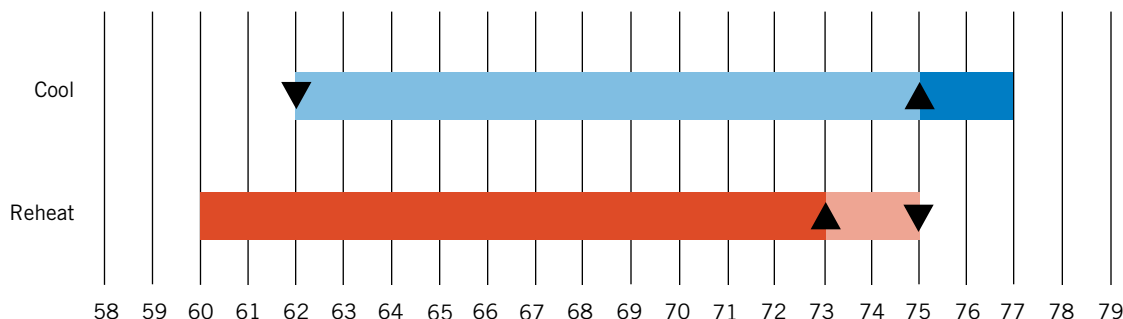

For a more detailed operation description, see the 2100-669 LC6000 Service Instructions manual.

### Mechanical Dehumidification

Mechanical dehumidification is only available as a factory-installed option that must be ordered with the unit. It cannot be installed in the field on an existing unit.

Dehumidification will only become active if the unit is connected to the LC6000 and the appropriate conditions are present.

When the wall-mount unit receives a dehumidification call from the LC6000, the wall-mount unit will disable the economizer to force the system to use air conditioning and prevent any additional humidity from being introduced from outdoor air. The wall-mount unit will then turn on the air conditioning system which will remove moisture and cool the space. At the same time, the 3-way dehumidification valve will be opened to extend the run time of the cooling cycle and prevent cool air from being introduced to the space. The dehumidification sequence will run until the space temperature reaches the heating setpoint or cooling setpoint or the humidity setpoint is reached.

When the dehumidification command is first received both cooling and reheat will be activated.

The cooling will shut off when the return air temperature is 62°F to prevent the unit from causing the system to go into heating mode (see Figure 25). The compressor will turn on again once the return temperature rises to 75°F.

The electric heat will operate to maximize cooling times which will in turn remove moisture from the space. The electric reheat will turn on when the temperature falls to 73°F and will turn back off at 75°F.

The system will continue to operate this way until the LC removes the call for active dehumidification.

The reheat coil is dependent on space load to warm the temperature back up once the compressor is disabled.

A heating or cooling call will disable the dehumidification call. Dehumidification can only take place when system is not actively heating or cooling.

For a more detailed operation description, see the 2100-669 LC6000 Service Instructions manual.

**FIGURE 26**  
**Wall-Mount Unit Control Board**

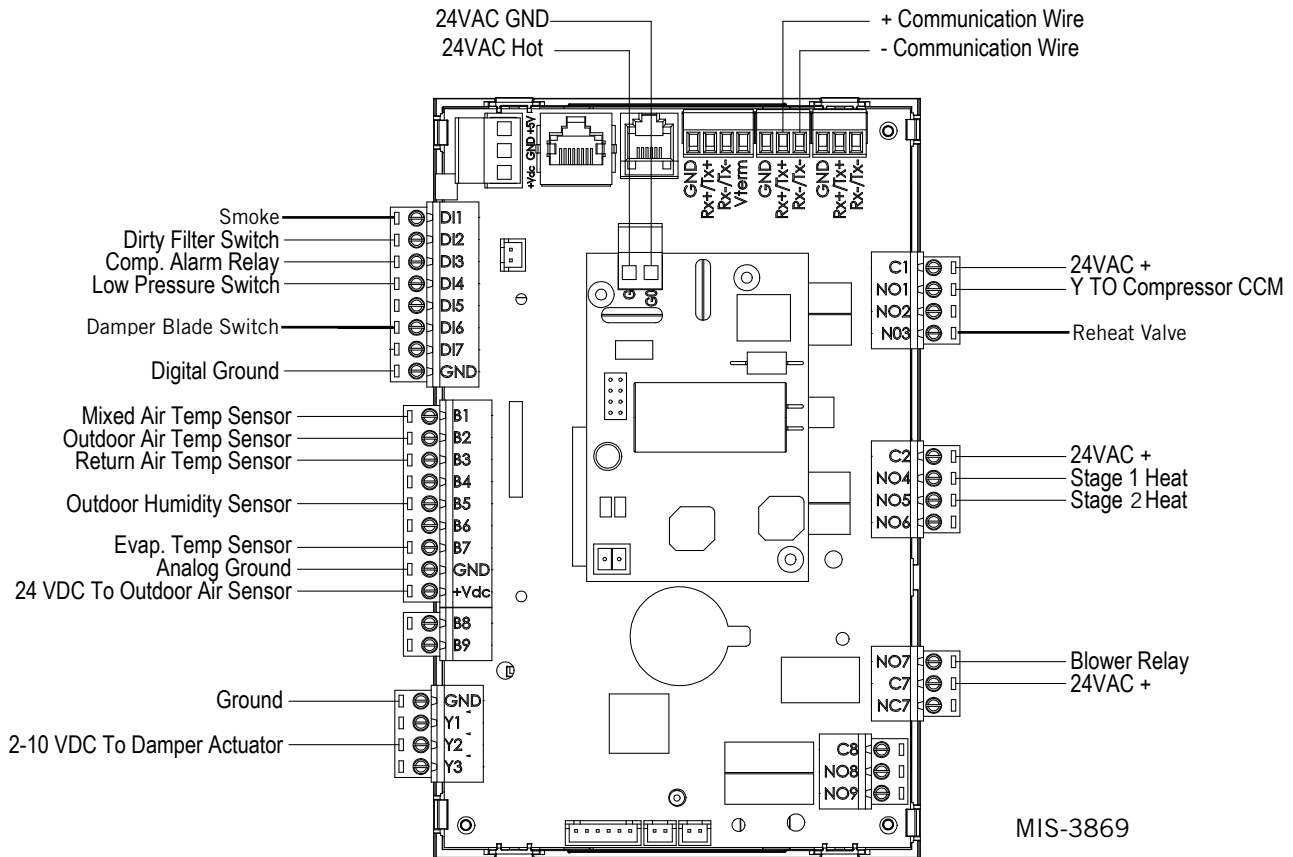

# GENERAL REFRIGERANT INFORMATION

## NOTICE

These units require R-410A refrigerant and polyol ester oil.

### General

1. Use separate service equipment to avoid cross contamination of oil and refrigerants.
2. Use recovery equipment rated for R-410A refrigerant.
3. Use manifold gauges rated for R-410A (800 psi/250 psi low).
4. R-410A is a binary blend of HFC-32 and HFC-125.
5. R-410A is nearly azeotropic—similar to R-22 and R-12. Although nearly azeotropic, charge with liquid refrigerant.
6. R-410A operates at 40-70% higher pressure than R-22, and systems designed for R-22 cannot withstand this higher pressure.
7. R-410A has an ozone depletion potential of zero, but must be reclaimed due to its global warming potential.
8. R-410A compressors use polyol ester oil.
9. Polyol ester oil is hygroscopic; it will rapidly absorb moisture and strongly hold this moisture in the oil.
10. A liquid line dryer must be used—even a deep vacuum will not separate moisture from the oil.
11. Limit atmospheric exposure to 15 minutes.
12. If compressor removal is necessary, always plug compressor immediately after removal. Purge with small amount of nitrogen when inserting plugs.

### Topping Off System Charge

If a leak has occurred in the system, Bard Manufacturing recommends reclaiming, evacuating (see criteria above) and charging to the nameplate charge. If done correctly, topping off the system charge can be done without problems.

With R-410A, there are no significant changes in the refrigerant composition during multiple leaks and recharges. R-410A refrigerant is close to being an azeotropic blend (it behaves like a pure compound or single component refrigerant). The remaining refrigerant charge in the system may be used after leaks have occurred. “Top-off” the charge by utilizing the pressure charts on the inner control panel cover as a guideline.

**REMEMBER:** When adding R-410A refrigerant, it must come out of the charging cylinder/tank as a liquid to avoid any fractionation and to insure optimal system performance. Refer to instructions for the cylinder that is being utilized for proper method of liquid extraction.

### Safety Practices

1. Never mix R-410A with other refrigerants.
2. Use gloves and safety glasses. Polyol ester oils can be irritating to the skin, and liquid refrigerant will freeze the skin.
3. Never use air and R-410A to leak check; the mixture may become flammable.
4. Do not inhale R-410A—the vapor attacks the nervous system, creating dizziness, loss of coordination and slurred speech. Cardiac irregularities, unconsciousness and ultimately death can result from breathing this concentration.
5. Do not burn R-410A. This decomposition produces hazardous vapors. Evacuate the area if exposed.
6. Use only cylinders rated DOT4BA/4BW 400.
7. Never fill cylinders over 80% of total capacity.
8. Store cylinders in a cool area, out of direct sunlight.
9. Never heat cylinders above 125°F.
10. Never trap liquid R-410A in manifold sets, gauge lines or cylinders. R-410A expands significantly at warmer temperatures. Once a cylinder or line is full of liquid, any further rise in temperature will cause it to burst.

### Important Installer Note

For improved start up performance, wash the indoor coil with a dishwashing detergent.

### R410-A Refrigerant Charge

This unit was charged at the factory with the quantity of refrigerant listed on the serial plate. AHRI capacity and efficiency ratings were determined by testing with this refrigerant charge quantity.

The pressure table found on page 20 shows nominal pressures for the units. Since many installation specific situations can affect the pressure readings, this information should only be used by certified technicians as a guide for evaluating proper system performance. They shall not be used to adjust charge. If charge is in doubt, reclaim, evacuate and recharge the unit to the serial plate charge.

**TABLE 4  
MULTI-TEC Cooling Pressures**

Air Temperature Entering Outdoor Coil °F

Model	Return Air Temp (DB/WB)	Pressure	75	80	85	90	95	100	105	110	115	120	125
W18A/L	75/62	Low Side High Side	121 293	123 312	126 332	128 353	131 376	134 400	136 425	137 452	140 480	142 510	144 540
	80/67	Low Side High Side	129 300	132 320	135 340	137 362	140 386	143 410	145 436	147 464	150 492	152 523	154 554
	85/72	Low Side High Side	134 311	137 331	140 352	142 375	145 400	148 424	150 451	152 480	155 509	157 541	159 573
W24A/L	75/62	Low Side High Side	123 314	124 334	126 355	128 377	129 401	131 425	133 451	135 479	137 507	139 536	141 567
	80/67	Low Side High Side	132 322	133 343	135 364	137 387	138 411	140 436	142 463	144 491	146 520	149 550	151 582
	85/72	Low Side High Side	137 333	138 355	140 377	142 401	143 425	145 451	147 479	149 508	151 538	154 569	156 602
W30A/L	75/62	Low Side High Side	118 312	120 333	122 355	124 378	126 403	128 428	131 454	133 483	135 511	137 540	138 570
	80/67	Low Side High Side	126 320	128 342	131 364	133 388	135 413	137 439	140 466	142 495	144 524	146 554	148 585
	85/72	Low Side High Side	130 331	132 354	136 377	138 402	140 427	142 454	145 482	147 512	149 542	151 573	153 605
W36A/L	75/62	Low Side High Side	117 323	120 346	122 370	124 394	127 419	129 446	131 473	134 500	136 528	137 558	138 587
	80/67	Low Side High Side	125 331	128 355	130 379	133 404	136 430	138 457	140 485	143 513	145 542	147 572	148 602
	85/72	Low Side High Side	129 343	132 367	135 392	138 418	141 445	143 473	145 502	148 531	150 561	152 592	153 623
W42A/L	75/62	Low Side High Side	123 323	125 346	128 371	130 395	132 421	135 447	137 474	138 501	140 528	142 558	144 587
	80/67	Low Side High Side	132 331	134 355	137 380	139 405	141 432	144 458	146 486	148 514	150 542	152 572	154 602
	85/72	Low Side High Side	137 343	139 367	142 393	144 419	146 447	149 474	151 503	153 532	155 561	157 592	159 623
W48A/L	75/62	Low Side High Side	120 330	122 353	125 377	127 402	130 428	132 454	134 482	136 510	137 540	139 570	141 601
	80/67	Low Side High Side	128 338	131 362	134 387	136 412	139 439	141 466	143 494	145 523	147 554	149 585	151 616
	85/72	Low Side High Side	132 350	136 375	139 401	141 426	144 454	146 482	148 511	150 541	152 573	154 605	156 638
W60A/L	75/62	Low Side High Side	127 344	129 362	131 380	134 401	136 421	137 444	140 467	142 492	145 518	148 545	151 573
	80/67	Low Side High Side	136 353	138 371	140 390	143 411	145 432	147 455	150 479	152 505	155 531	158 559	161 588
	85/72	Low Side High Side	141 365	143 384	145 404	148 425	150 447	152 471	155 496	157 523	160 550	164 579	167 609
W72A/L	75/62	Low Side High Side	117 332	119 353	121 376	122 402	124 427	126 454	128 483	130 512	132 542	134 574	136 607
	80/67	Low Side High Side	125 340	127 362	129 386	131 412	133 438	135 466	137 495	139 525	141 556	143 589	145 623
	85/72	Low Side High Side	129 352	131 375	134 400	136 426	138 453	140 482	142 512	144 543	146 575	148 610	150 645

Low side pressure ± 4 PSIG  
High side pressure ± 10 PSIG

Tables are based upon rated CFM (airflow) across the evaporator coil. If there is any doubt as to correct operating charge being in the system, the charge should be removed and system evacuated and recharged to serial plate charge weight.

**NOTE:** Pressure table based on high speed condenser fan operation. If condensing pressures appear elevated check condenser fan wiring. See "Condenser Fan Operation".

## **WARNING**

**Electrical shock hazard.**

**Disconnect VAC power supply before servicing.**

**Failure to do so could result in electric shock or death.**

### **High Pressure Switch**

All W\*\*A/W\*\*L wall-mount air conditioner series models are supplied with a high pressure switch. The high pressure switch opens at 650 psi.

### **Three Phase Scroll Compressor Start Up Information**

Scroll compressors, like several other types of compressors, will only compress in one rotational direction. Direction of rotation is not an issue with single phase compressors since they will always start and run in the proper direction.

However, three phase compressors will rotate in either direction depending upon phasing of the power. Since there is a 50-50 chance of connecting power in such a way as to cause rotation in the reverse direction, verification of proper rotation must be made. Verification of proper rotation direction is made by observing that suction pressure drops and discharge pressure rises when the compressor is energized. Reverse rotation also results in an elevated sound level over that with correct rotation, as well as substantially reduced current draw compared to tabulated values.

Verification of **proper rotation** must be made at the time the equipment is put into service. If improper rotation is corrected at this time, there will be no negative impact on the durability of the compressor. However, reverse operation for over 1 hour may have a negative impact on the bearing due to oil pump out.

**NOTE:** *If compressor is allowed to run in reverse rotation for an extended period of time, the compressor's internal protector will trip.*

All three phase compressors are wired identically internally. As a result, once the correct phasing is determined for a specific system or installation, connecting properly phased power leads to the same Fusite terminal should maintain proper rotation direction.

The direction of rotation of the compressor may be changed by reversing any two line connections to the unit.

### **Phase Monitor**

Used only on 3-phase equipment, the phase monitor is a compressor protection device that will prohibit operation of the compressor if the device senses a possible reverse-rotation situation due to incorrect phasing. On a call for compressor (and only compressor), the device will check incoming phase, check for severe voltage imbalance and check for proper frequency. Under nominal conditions, a green LED light will show on the face of the monitor. If there is improper phasing, voltage imbalance or frequency deviation, the device will show a red LED light and prohibit compressor operation.

If a fault condition occurs, reverse two of the supply leads to the unit. **Do not reverse any of the unit factory wires as damage may occur.**

### **Condenser Fan Operation**

**NOTE:** *On models equipped with a low ambient control (LAC), the condenser fan motor will have a delayed start until system refrigerant operating pressure builds up. After starting, the fan motor may or may not cycle depending upon ambient conditions. This is normal operation.*

The condenser fan motor on 230/208 volt, one and three phase, 60 HZ units is a two-speed motor that comes factory wired on high speed for peak performance. If ambient conditions permit, it can be reconnected to low speed (red wire) for lower sound level. See unit wiring diagram. (*This applies to W42, W48, W60 and W72 models only.*)

### **Low Ambient Control**

Modulating head-pressure control that allows full speed at pressures above 315 psi. Below 315 psi, the control will slow fan speed—following internal head pressures—until a minimum RPM is reached (approx 300 RPM). Below this point, the control will shut the fan completely off until internal pressures rise. The control is preset from the factory, but should adjustment become necessary, there is an adjustment screw located on the bottom of the control behind a weatherproof cap. One full turn clockwise equals approximately +48 psi.

## Compressor Control Module

The compressor control module (CCM) is standard on all models covered by this manual.

### Features

Delay-on-Make Timer  
 Short Cycle Protection/Delay-on-Break  
 High Pressure Detection  
 HPC Status LED  
 Test Mode  
 Brownout Protection with Adjustment

### Delay-on-Make Timer

A delay-on-make timer is included to be able to delay startup of the compressor. This is desired when more than one unit is on a structure so that all of the units do not start at the same time which could happen after a power loss or building shutdown. The delay-on-make time period is 2 minutes plus 10% of the delay-on-break time period. To ensure that all of the units do not start at the same time, adjust the delay-on-break timer on each unit to a slightly different delay time.

### Short Cycle Protection/Delay-on-Break

An anti-short cycle timer is included to prevent short cycling the compressor. This is adjustable from 30 seconds to 5 minutes via the adjustment knob. Once a compressor call is lost, the time period must expire before a new call will be initiated.

### High Pressure Detection

High pressure switch monitoring allows for a lockout condition in a situation where the switch is open. If the high pressure switch opens, the CCM will de-energize the compressor. If the switch closes again, it will then restart the compressor after the delay-on-break setting has expired on the device. If the switch trips again during the same thermostat call, the compressor will be de-energized and the alarm terminal will be energized indicating an alarm. The red LED will light and stay on until power is cycled to the control or a loss of voltage is present at Y terminal for more than ½ second.

### Test Mode

By rapidly rotating the potentiometer (POT) clockwise (see Figure 27), all timing functions will be removed for testing.

FIGURE 27  
 8201-164 Compressor Control Module

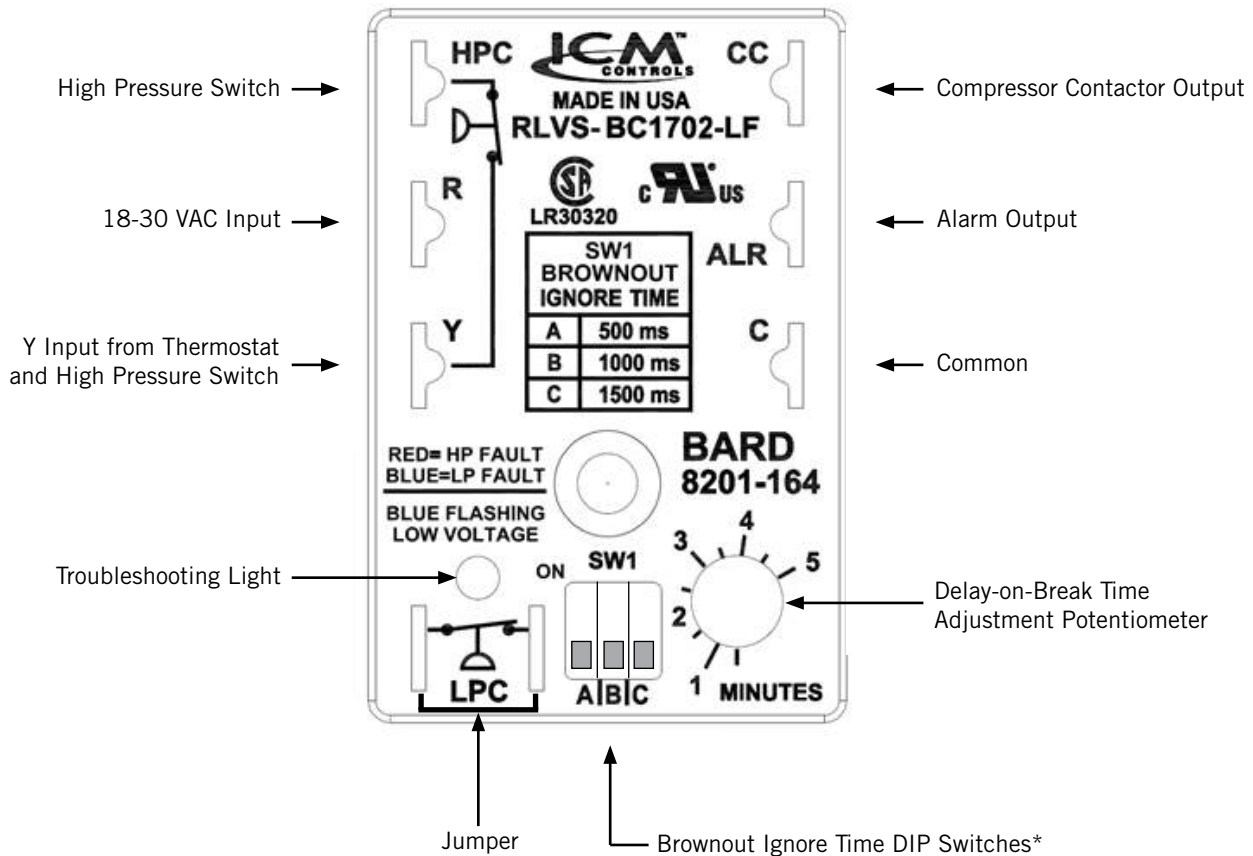

\* Turn on only one switch for that specific ignore time setting

The conditions needed for the unit to enter test mode are as follows: POT must start at a time less than or equal to the 40 second mark. The POT must then be rapidly rotated to a position greater than or equal to the 280 second mark in less than ¼ second. Normal operation will resume after power is reset or after the unit has been in test mode for at least 5 minutes.

### **Brownout Protection with Adjustment**

Brownout protection may be necessary if the utility power or generator power has inadequate power to prevent the voltage from dropping when the compressor starts. This is rare but can happen if the generator is undersized at the site or if the site is in a remote location far from the main power grid. Under normal circumstances, allowing the brownout to be ignored for a time period should not be needed. The 8201-164 is shipped with all the DIP switches in the 'off' or 'do not ignore' position (see Figure 27).

If ignoring the brownout is needed because of the above conditions, three preset timers can be set by DIP switches in order to delay signaling a power brownout for a specific length of time after compressor contactor is energized. This allows the compressor a time period to start even if the voltage has dropped and allows the voltage to recover. This delay only happens when the CC terminal energizes. The delay can be set to 500 milliseconds (A DIP switch), 1000 milliseconds (B DIP switch) or 1500 milliseconds (C DIP switch); time is not cumulative—only the longest setting will apply. If the voltage recovers during the brownout time period, the compressor will start.

If a brownout condition is detected by the 8201-164, the troubleshooting light will flash blue. The light will continue to flash until the cooling call is satisfied or power is removed from the Y terminal. This condition does not prevent operation, it only indicates that a brownout condition was present at some point during the cooling call. If a brownout condition is detected, CC will be de-energized and will retry after the delay-on-make timer is satisfied; this process will continue until call is satisfied.

If user chooses the 'do not ignore' position when the site has inadequate utility or generator power, this could lead to the compressor never starting. The control will see the brownout immediately and not start.

A common scenario and one that has been seen in the field is when a unit or units switches from utility power to generator power. With slower transfer switches, the time delay between the utility power and generator power didn't cause a problem. The units lost power, shut off and came back on line normally. With the introduction of almost instantaneous transfer switches, the millisecond long power glitch can be enough that the compressor will start to run backwards. In this scenario, the CCM will catch this and restart the units normally.

## **Pressure Service Ports**

High and low pressure service ports are installed on all units so that the system operating pressures can be observed. A pressure table covering all models can be found on page 20. It is imperative to match the correct pressure table to the unit by model number.

This unit employs high-flow Coremax valves instead of the typical Schrader type valves.

**WARNING! Do NOT use a Schrader valve core removal tool with these valves. Use of such a tool could result in eye injuries or refrigerant burns!**

To change a Coremax valve without first removing the refrigerant, a special tool is required which can be obtained at [www.fastestinc.com/en/SCCA07H](http://www.fastestinc.com/en/SCCA07H). See the replacement parts manual for replacement core part numbers.

## **Outdoor Fan Motor**

Due to design considerations of the condenser section of the wall-mount unit, placement/clearance of the motor/fan blade is critical to heat dispersal. Should a change of motor or fan blade be necessary, please view Figure 28 for proper clearance adjustment.

**FIGURE 28**  
**Fan Blade Setting**

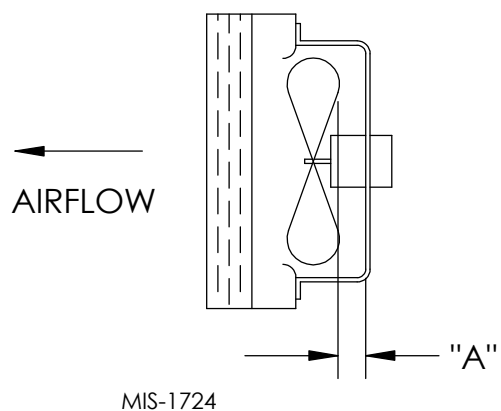

Model	Dimension A
W18A/W18L W24A/W24L	1.00"
W30A/W30L W36A/W36L	1.25"
W42A/W42L W48A/W48L W60A/W60L W72A/W72L	1.75"



**TABLE 5A**  
**MULTI-TEC Optional Accessories – Right Hand**

	W18A**A	W24A**A	W24A**B	W24A**C	W30A**A	W30A**B	W30A**C	W36A**A	W36A**B	W36A**C	W42A**A	W42A**B	W42A**C	W48A**A	W48A**B	W48A**C	W60A**A	W60A**B	W60A**C	W72A**A	W72A**B	W72A**C	
<b>Heater Kits</b>	EHW2TA-A05	X	X																				
	EHW2TA-A08	X	X																				
	EHW2TA-A10	X	X																				
	EHWA24-A04B		X																				
	EHW2TA-B06			X																			
	EHWH24B-C06				X																		
	EHW3TA-A05					X			X														
	EHW3TA-A08					X			X														
	EHW3TA-A10					X			X														
	EHW3TA-A15					X			X														
	EHW30A-B06						X																
	EHW3TA-B06									X													
	EHW3TA-B09						X			X													
	EHW3TA-B15						X			X													
	EHW3TA-C06							X			X												
	EHW3TA-C09							X			X												
	EHW3TA-C12							X			X												
	EHW3TA-C15							X			X												
	EHW4TA-A05											X			X								
	EHWA05-A10B											X			X			X					
	EHWA05-A15B											X			X			X					
	EHWA05-A20B											X			X			X					
	EHW4TA-B06											X			X			X					
	EHWA05-B09B											X			X								
	EHW6TA-B06																						X
	EHWA05-B15B											X			X			X					X
	EHW5TA-B18																	X					
	EHW4TA-B18											X			X								
	EHW4TA-C09												X			X			X				X
	EHW4TA-C15												X			X			X				X
	EHW5TA-A05																	X			X		
	EHW60A-B09B																		X				
	EHW70A-B09B																						X
	EHW6TA-B18																						X
EHW72A-A10B																					X		
EHW72A-A15B																					X		
EHW72A-A20B																					X		
<b>Circuit Breaker (WMCB) and Toggle Disconnect (WMPD)</b>	WMCB-01B			X																			
	WMCB-02A	X																					
	WMCB-02B					X																	
	WMCB-03A		X																				
	WMCB-04B								X														
	WMCB-05A					X		X															
	WMCB-05B										X				X								
	WMCB-06B																	X					
	WMCB-08A											X			X								
	WMCB-09A																	X			X		
	WMPD-01C				X		X		X			X			X			X		X			X
	WMCB-08B																						X



**TABLE 5B**  
**MULTI-TEC Optional Accessories – Left Hand**

	W18L**A	W24L**A	W24L**B	W30L**A	W30L**B	W30L**C	W36L**A	W36L**B	W36L**C	W42L**A	W42L**B	W42L**C	W48L**A	W48L**B	W48L**C	W60L**A	W60L**B	W60L**C	W72L**A	W72L**B	W72L**C	
<b>Heater Kits</b>	EHW2TA-A05L	X	X																			
	EHW2TA-A08L	X	X																			
	EHW2TA-A10L	X	X																			
	EHW2TA-B06L			X																		
	EHW3TA-A05L				X		X															
	EHW3TA-A08L				X																	
	EHW3TA-A10L				X		X															
	EHW3TA-A15L				X		X															
	EHW3TA-B09L					X		X														
	EHW3TA-B15L					X		X														
	EHW3TA-C09L						X		X													
	EHW3TA-C15L						X		X													
	EHW4TA-A05L									X				X			X					
	EHWA05-A10LB									X				X			X					
	EHWA05-A15LB									X				X			X					
	EHW4TA-B06L										X			X			X					
	EHWA05-B09LB										X			X								
	EHW6TA-B06L																					X
	EHWA05-B15LB										X			X			X					X
	EHW4TA-C09L											X			X			X				X
	EHW4TA-C15L											X			X			X				X
	EHW6TA-A05L																				X	
	EHWA60-B09LB																X					
	EHW70A-B09LB																					X
EHW72A-A10LB																				X		
EHW72A-A15LB																				X		
<b>Circuit Breaker (WMCB) and Toggle Disconnect (WMPD)</b>	WMCB-01B			X																		
	WMCB-02A	X																				
	WMCB-02B					X																
	WMCB-03A		X																			
	WMCB-04B							X														
	WMCB-05A				X		X															
	WMCB-05B									X				X								
	WMCB-06B																X					
	WMCB-08A									X				X								
	WMCB-09A															X			X			
	WMPD-01C						X		X			X			X			X				X
WMCB-09B																				X		

# MAINTENANCE AND TROUBLESHOOTING

## Standard Maintenance Procedures

### **WARNING**

**Electrical shock hazard.**

**Disconnect all power supplies before servicing.**

**Failure to do so could result in electric shock or death.**

### **CAUTION**

**Cut hazard.**

**Wear gloves to avoid contact with sharp edges.**

**Failure to do so could result in personal injury.**

1. Disable system from LC6000 controller (see latest version of 2100-669 LC6000 Service Instructions manual).
2. Turn off AC breakers at wall-mount units.
3. Check inlet sides of condenser and evaporator coils for obstructions/debris—clean if necessary using a quality manufactured coil cleaning product specific for the evaporator or condenser coil.
  - Condenser coil: Remove the fan shroud/motor/motor bracket as an assembly from the condenser section. This will give clear access to the inlet side of the coil for cleaning. Follow the coil cleaner manufacturer's directions for necessary safety gear and precautions, as well as for application and use. More than one application may be necessary. Rinse thoroughly.
  - Evaporator coil: Remove the evaporator section panel and apply specific evaporator cleaner directly to the inlet side of coil, being very careful not to overspray into insulation or surrounding panels and wiring. Residual cleaner and dissolved debris should drip into the drain pan and leave the unit through the condensate hose. More than one application may be necessary. Rinse thoroughly.
4. Manually spin fan and blower motors to ensure they turn freely. All motors are permanently lubricated, so no oil is necessary.
5. Inspect free cooling damper actuator and linkage.
6. Install new air filter; check for additional filter grilles internal to the structure.
7. Inspect the control panel of the system.
  - Look for insect or rodent activity and remove any nesting materials.
  - Manually push contactor closed, observe for movement—contactor points should have minimal discoloration, no spalling or other signs of arcing. Replace if doubtful.
  - Check field and factory wiring for tightness and look for signs of overheating (discoloration of terminals or wire insulation).
8. Ensure that supply and return registers are not obstructed, and more importantly, are not recycling the air to one another. Adjust supply louvers if necessary to direct discharge air away from any direct route to the return grille.
9. Re-assemble wall-mount unit, turn breakers back on.
10. Enable system to LC6000 controller (see latest version of 2100-669 LC6000 Service Instructions manual).
11. Repeat steps for additional wall-mount units.

## Removal of Fan Shroud

1. Disconnect all power to the unit.
2. Remove the screws holding both grilles, one on each side of unit, and remove grilles.
3. Remove nine screws holding fan shroud to condenser and bottom.
4. Unwire condenser fan motor.
5. Slide complete motor, fan blade and shroud assembly out the left side of the unit.
6. Service motor/fan as needed. Any service work requiring removal or adjustment in the fan and/or motor will require that the dimensions be checked and blade adjusted in or out on the motor shaft accordingly (see page 23 for proper clearance adjustment).
7. Reverse steps to re-install.

## Troubleshooting Nidec SelecTech Series ECM Motors

### If the Motor Is Running

1. It is normal for the motor to rock back and forth on start up. Do not replace the motor if this is the only problem identified.
2. If the system is excessively noisy, does not appear to change speeds in response to a demand (Heat, Cool, Other) or is having symptoms during the cycle such as tripping limit or freezing coil, check the following:
  - A. Wait for programmed delays to time out.
  - B. Ensure that the motors control inputs are wired as shown in the factory-supplied wiring diagram to ensure motor is getting proper control signals and sequencing.
  - C. Remove the filter and check that all dampers, registers and grilles are open and free flowing. If removing the filters corrects the problem, clean or replace with a less restrictive filter. Also check and clean the blower wheel or coil as necessary.

- D. Check the external static pressure (total of both supply and return) to ensure it is within the range as listed on the unit serial plate. If higher than allowed, additional duct work is needed.
- E. If the motor does not shut off at the end of the cycle, wait for any programmed delays to time out (no more than 90 seconds). Also make sure that there is no call for "Continuous Fan" on the "G" terminal.
- F. If the above diagnostics do not solve the problem, confirm the voltage checks in the next section below, then continue with the **Model SelecTech Communication Diagnostics**.

### If the Motor Is Not Running

1. Check for proper high voltage and ground at the L/L1, G and N/L2 connections at the motor (see Figure 29). Correct any voltage issues before proceeding to the next step. The SelecTech motor is voltage specific. Only the correct voltage should be applied to the proper motor. Input voltage within plus or minus 10% of the nominal line power VAC is acceptable.

**FIGURE 29**  
**Motor Connections**

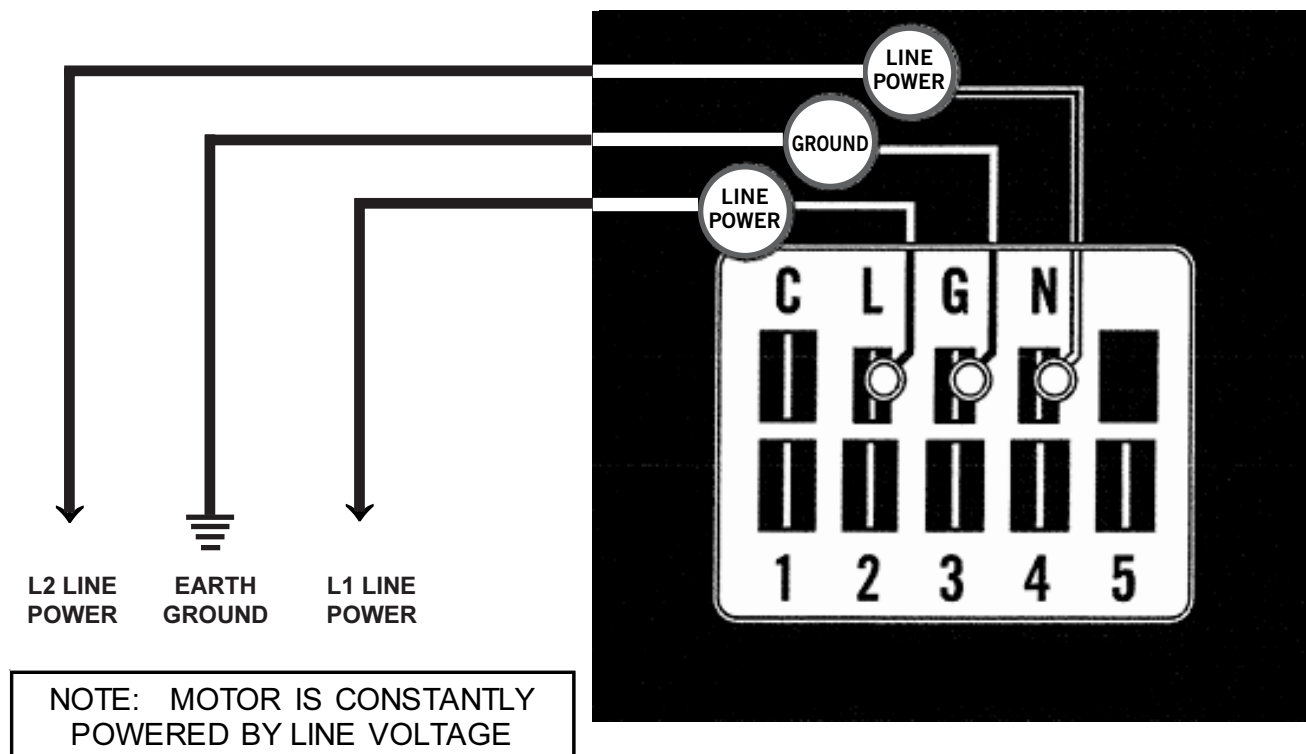

2. If the motor has proper high voltage and ground at the L/L1, G and N/L2 connections, continue with the **Model SelecTech Communication Diagnostics**.

**Model SelecTech Communication Diagnostics**

The SelecTech motor is communicated through 24 VAC low voltage (thermostat control circuit wiring).

1. Start with unit wiring diagram to confirm proper connections and voltage (see Figure 30).
2. Initiate a demand from the thermostat and check the voltage between the common and the appropriate motor terminal (1-5). ("G" input is typically on terminal #1, but always refer to wiring diagram.)

- A. If the low voltage communication is not present, check the demand from the thermostat. Also check the output terminal and wire(s) from the terminal strip or control relay(s) to the motor.
- B. If the motor has proper high voltage as identified on page 27 (Step 1 in **If the Motor Is Not Running**), proper low voltage to a programmed terminal and is not operating, the motor is failed and will require replacement.

**FIGURE 30**  
**Motor Connections**

