

---

# SERVICE INSTRUCTIONS

---

## FUSION-TEC® WALL-MOUNT AIR CONDITIONER

Models:

HR36APA HR36APB  
HR58APA HR58APB

**Part of the Bard Free Cooling System**

***NOTE: LV1000 Controller is required for operation when multiple HR\*\*AP\* units are used.***



Climate Control Solutions

Bard Manufacturing Company, Inc.  
Bryan, Ohio 43506  
[www.bardhvac.com](http://www.bardhvac.com)

Manual: 2100-670I  
Supersedes: 2100-670H  
Date: 9-26-18

# CONTENTS

<b>Using the TEC-EYE™</b> .....	<b>6</b>	Dirty Filter Switch.....	20
TEC-EYE Hand-Held Diagnostic Tool.....	6	Dirty Filter Alarm.....	20
TEC-EYE Menu Structure.....	7	Filter Indicator Light.....	20
TEC-EYE Acronyms.....	7	Freezestat.....	20
Main Status Screen.....	7	Indoor Airflow Operation.....	20
Quick Menu.....	8	Blower Speed Control.....	20
Setpoints.....	8	Additional Indoor Airflow Alarms.....	22
Information.....	8	Supply Air Temperature Alarm.....	22
Staging Information.....	8	Condenser Fan.....	22
Stand Alone Demand and Staging.....	8	Condenser Fan Components.....	22
Master Staging.....	8	Condenser Fan.....	22
A/C Circuit Measurements.....	9	Liquid Line Pressure Transducer.....	22
Last 24 Hour Operation.....	9	Troubleshooting the Discharge/ Liquid Pressure Transducer.....	23
Software Version.....	9	Discharge/Liquid Pressure Transducer Alarm.....	23
Alarm Log.....	9	Liquid Temperature Sensor.....	23
Addressing Wall-Mount Units.....	10	Condenser Fan Operation.....	23
Executing a Run Test.....	10	Condenser Fan Speed Control.....	23
Run Test Parameter Descriptions.....	11	Mechanical Cooling Only.....	23
Reset to Factory Defaults.....	11	Optimized Cooling (Concurrent Economizer and Mechanical Cooling).....	23
<b>Operation</b> .....	<b>12</b>	High Pressure Control.....	24
Unit On/Off.....	12	Condenser Fan Speed.....	24
Alarm Adjustment.....	12	Second Stage Drop Out.....	24
Acknowledging Alarms.....	12	Low Ambient Control.....	24
Clearing Alarms.....	12	Additional Condenser Fan Alarms.....	24
Clearing Alarm Logs and Counters.....	12	Dirty Condenser Coil Alarm.....	24
Exporting Alarm Logs.....	12	Compressor.....	25
Exporting 7 Day Logs.....	12	Compressor Components.....	25
Stand Alone (Orphan) Mode.....	12	Compressor.....	25
Temperature/Humidity Control.....	13	Compressor Control Module (CCM).....	25
Temperature/Humidity Control Components.....	13	Delay-on-Make Timer.....	25
Return Air Temperature Sensor.....	13	Short Cycle Protection/ Delay-on-Break.....	25
Return Air Temperature Alarm.....	13	High Pressure Detection.....	25
Temperature/Humidity Control Operation.....	13	Test Mode.....	26
Cooling.....	13	Brownout Protection w/Adjustment.....	26
Cooling w/No Economizer.....	13	High Pressure Safety Switch.....	27
Heating.....	15	Refrigerant High Pressure Alarm.....	27
Staging.....	15	Phase Monitor.....	27
Dehumidification.....	15	Compressor Operation.....	27
Electronic Expansion Valve (EEV).....	15	Additional Compressor Alarms.....	28
EEV Components.....	15	Refrigerant Low Pressure Alarm.....	28
Electronic Expansion Valve.....	15	Economizer.....	28
EEV Instructions for Vacuum, Reclaim, Charge Unit.....	15	Economizer Components.....	28
System Pressures.....	16	Actuator.....	28
Suction Pressure Transducer.....	16	Dust Sensor.....	28
Troubleshooting the Suction Pressure Transducer.....	17	Dust Sensor Failure Alarm.....	29
Suction Pressure Alarm.....	17	High Dust Limit Alarm.....	29
Suction Temperature Sensor.....	17	Damper Blade.....	29
Suction Temperature Alarm.....	17	Damper Switch.....	29
Evaporator Freeze Condition Alarm.....	17	Damper Failed to Open Alarm.....	30
EEV Operation.....	18	Damper Failed to Close Alarm.....	30
EEV Superheat Control.....	18	Outdoor Temperature and Humidity Combination Sensor.....	30
Additional EEV Alarms.....	18	Outdoor Temperature Sensor Failure Alarm.....	31
Low Superheat Alarm.....	18	Outdoor Humidity Sensor Failure Alarm.....	31
Indoor Airflow.....	18		
Indoor Airflow Components.....	18		
Blower.....	18		
Blower Status Switch.....	19		
Blower Status Alarm.....	20		
Filters.....	20		

Supply Temperature Sensor .....	31	Figure 26	Voltage to Pressure: Suction Pressure Transducer .....	17	
Supply Temperature Sensor Failure Alarm.....	32	Figure 27	Adjusting Suction Temperature Sensor Values.....	17	
High Supply Air Temperature Alarm .....	32	Figure 28	Adjusting Freeze Setpoint and Alarm Delay ..	18	
Low Supply Air Temperature Alarm .....	32	Figure 29	Putting Blower Output into Override Mode.....	18	
Economizer Operation .....	32	Figure 30	Dirty Filter Switch/Blower Status Switch.....	19	
Emergency Cooling Mode.....	34	Figure 31	Verifying Differential Airflow Status.....	19	
Emergency Ventilation Mode.....	34	Figure 32	Adjusting Air Flow Alarm Delay .....	20	
Model/Serial Number Configuration .....	34	Figure 33	Dirty Filter Switch and Filter Indicator Light ..	21	
Electric Heat Option .....	34	Figure 34	Verifying Condenser Fan Output .....	22	
Electric Heat Components .....	34	Figure 35	Fan Blade Setting.....	22	
Electric Heating Element.....	34	Figure 36	Adjusting Discharge/Liquid Transducer Pressure Values .....	23	
Thermal Overload.....	34	Figure 37	Voltage to Pressure: Discharge/Liquid Pressure Transducer.....	23	
Electric Heat Operation .....	34	Figure 38	Adjusting Discharge/Liquid Temperature Input .....	23	
Bard Guard Anti-Theft System Option .....	35	Figure 39	Condenser Fan Speed Control .....	24	
Smoke Detector Unit Disable Option.....	35	Figure 40	Adjusting Dirty Condenser Coil Alarm Settings .....	25	
Inverter Option .....	35	Figure 41	8201-164 Compressor Control Module .....	26	
<b>Refrigerant Information .....</b>	<b>39</b>	Figure 42	Adjusting Compressor Delays .....	27	
General.....	39	Figure 43	Adjusting Low Pressure Alarm Settings .....	28	
Topping Off System Charge.....	39	Figure 44	Damper Override.....	28	
Safety Practices.....	39	Figure 45	Dust Sensor .....	29	
Important Installer Note .....	39	Figure 46	Adjusting Dust Sensor Alarm Setpoint .....	29	
R410-A Refrigerant Charge.....	39	Figure 47	Damper Switch.....	30	
Pressure Service Ports.....	40	Figure 48	Adjusting Damper Alarm Delay.....	30	
<b>Maintenance.....</b>	<b>41</b>	Figure 49	Outdoor Air Sensor.....	31	
Standard Maintenance Procedures .....	41	Figure 50	Outdoor Humidity Sensor.....	31	
Bard Guard Anti-Theft System Option .....	41	Figure 51	Supply Air Sensor .....	31	
<b>Troubleshooting .....</b>	<b>42</b>	Figure 52	Adjusting Supply Air Temperature Differential.....	32	
8301-067 Outdoor Temperature/Humidity Sensor.....	42	Figure 53	Economizer Setup.....	32	
8408-044 Return Air Sensor/Suction Sensor.....	45	Figure 54	Economizer Setup – Enthalpy Control .....	33	
8301-066 Supply Air Sensor .....	46	Figure 55	Economizer Setup – TempHum Control .....	33	
8301-057 Blower Status Switch/Dirty Filter Switch.....	47	Figure 56	Wall-Mount Unit Control Board.....	36	
<b>FIGURES AND TABLES</b>		Figure 57	Wall-Mount Unit Model Nomenclature .....	38	
Figure 1	TEC-EYE Display and Interface.....	6	Figure 58	8301-067 Sensor Dip Switches and Terminal Block .....	42
Figure 2	TEC-EYE Connection to Unit Control.....	6	Figure 59	8301-057 Air Differential Switch Terminals...	47
Figure 3	Quick Menu Icons.....	8	Table 1	LV1000/TEC-EYE Passwords (Defaults).....	6
Figure 4	Cool and Heat Setpoints .....	8	Table 2	Unit Status Messages.....	7
Figure 5	Stand Alone Demand and Staging .....	8	Table 3A	HR36AP* Blower Speeds .....	18
Figure 6	Master Staging .....	8	Table 3B	HR58AP* Blower Speeds .....	19
Figure 7	A/C Circuit Measurements.....	9	Table 4	Rated Airflow.....	19
Figure 8	Last 24 Operation .....	9	Table 5	Indoor Blower Performance.....	19
Figure 9	Software Version .....	9	Table 6	Maximum ESP of Operation: Electric Heat Only.....	19
Figure 10	Changing Unit Address.....	10	Table 7	Filter Switch Pressure Settings.....	21
Figure 11	Executing Run Test .....	10	Table 8	Economizer Default Settings .....	34
Figure 12	Run Test Summary.....	10	Table 9	Wall-Mount Unit Control Board Terminals .....	37
Figure 13	Run Test: Motors & Sensors .....	11	Table 10	Cooling Pressures .....	40
Figure 14	Run Test: A/C Circuit.....	11	Table 11	8301-067 Sensor: Temp/Resistance.....	43
Figure 15	Restoring Factory Default Settings.....	11	Table 12	8301-067 Sensor: Humidity/mA .....	44
Figure 16	Clearing All Alarms .....	12	Table 13	8408-044 Sensor: Temperature/Resistance Curve J .....	42
Figure 17	Clearing Alarm Logs and Counters .....	12	Table 14	8301-066 Sensor: Temperature/Resistance ...	46
Figure 18	Adjusting Return Air Sensor.....	13			
Figure 19	Cooling w/Economizer .....	14			
Figure 20	Cooling w/No Economizer .....	14			
Figure 21	Heating.....	14			
Figure 22	Viewing Unit Stages .....	15			
Figure 23	Overriding EEV Output .....	15			
Figure 24	Electronic Expansion Valve (EEV) and Service Tool.....	16			
Figure 25	Adjusting Suction Sensor/Transducer Pressure Values .....	16			

# GENERAL INFORMATION

---

## Free Cooling Unit System

This Bard Free Cooling Unit System is composed of FUSION-TEC HR Series wall-mounted air conditioners matched with an LV1000 lead/lag controller. The wall mounts are specifically engineered for telecom/motor control center rooms.

**NOTE:** *The LV1000 lead/lag controller and FUSION-TEC HR Series wall-mount units are designed specifically to work together. The controller cannot run other Bard models or other brands of systems, nor can other controllers run the FUSION-TEC HR Series wall-mount units. They are a complete system, and must be used together.*

## Wall-Mount Air Conditioner Units

The FUSION-TEC HR Series units operate on VAC power. The units will supply 100% of rated cooling airflow in free cooling mode with ability to exhaust the same amount through the unit itself without any additional relief openings in the shelter.

Each of these units are fully charged with refrigerant and have optional auxiliary heat.

## General

The equipment covered in this manual is to be installed by trained, experienced service and installation technicians.

The refrigerant system is completely assembled and charged. All internal wiring is complete.

The unit is designed for use without duct work. Flanges are provided for transition from unit to wall grilles.

These instructions explain the recommended method to install the air cooled self-contained unit and the electrical wiring connections to the unit.

These instructions and any instructions packaged with any separate equipment required to make up the entire air conditioning system should be carefully read before beginning the installation. Note particularly any tags and/or labels attached to the equipment.

While these instructions are intended as a general recommended guide, they do not supersede any national and/or local codes in any way. Authorities having jurisdiction should be consulted before the installation is made. See **Additional Publications** for information on codes and standards.

Sizing of systems for proposed installation should be based on heat loss and heat gain calculations made according to methods of Air Conditioning Contractors of America (ACCA). The supply flange should be installed in accordance with the *Standards of the National*

*Fire Protection Association for the Installation of Air Conditioning and Ventilating Systems of Other Than Residence Type, NFPA No. 90A, and Residence Type Warm Air Heating and Air Conditioning Systems, NFPA No. 90B.* Where local regulations are at a variance with instructions, installer should adhere to local codes.

## Shipping Damage

Upon receipt of equipment, the cartons should be checked for external signs of shipping damage. If damage is found, the receiving party must contact the last carrier immediately, preferably in writing, requesting inspection by the carrier's agent.

These units must remain in upright position at all times.

## Additional Publications

These publications can help when installing the air conditioner. They can usually be found at the local library or purchased directly from the publisher. Be sure to consult the current edition of each standard.

National Electrical Code.....ANSI/NFPA 70

Standard for the Installation of Air Conditioning and Ventilating Systems .....ANSI/NFPA 90A

Standard for Warm Air Heating and Air Conditioning Systems .....ANSI/NFPA 90B

Load Calculation for Residential Winter and Summer Air Conditioning ..... ACCA Manual J

For more information, contact these publishers:

### Air Conditioning Contractors of America (ACCA)

1712 New Hampshire Ave. N.W.  
Washington, DC 20009  
Telephone: (202) 483-9370 Fax: (202) 234-4721

### American National Standards Institute (ANSI)

11 West Street, 13th Floor  
New York, NY 10036  
Telephone: (212) 642-4900 Fax: (212) 302-1286

### American Society of Heating, Refrigeration and Air Conditioning Engineers, Inc. (ASHRAE)

1791 Tullie Circle, N.E.  
Atlanta, GA 30329-2305  
Telephone: (404) 636-8400 Fax: (404) 321-5478

### National Fire Protection Association (NFPA)

Batterymarch Park  
P. O. Box 9101  
Quincy, MA 02269-9901  
Telephone: (800) 344-3555 Fax: (617) 984-7057

## **ANSI Z535.5 Definitions:**

**DANGER:** Indicate[s] a hazardous situation which, if not avoided, will result in death or serious injury. The signal word “DANGER” is to be limited to the most extreme situations. DANGER [signs] should not be used for property damage hazards unless personal injury risk appropriate to these levels is also involved.

**WARNING:** Indicate[s] a hazardous situation which, if not avoided, could result in death or serious injury. WARNING [signs] should not be used for property damage hazards unless personal injury risk appropriate to this level is also involved.

**CAUTION:** Indicate[s] a hazardous situation which, if not avoided, could result in minor or moderate injury. CAUTION [signs] without a safety alert symbol may be used to alert against unsafe practices that can result in property damage only.

**NOTICE:** [this header is] preferred to address practices not related to personal injury. The safety alert symbol shall not be used with this signal word. As an alternative to “NOTICE” the word “CAUTION” without the safety alert symbol may be used to indicate a message not related to personal injury.



## **WARNING**

***Electrical shock hazard.***

***Have a properly trained individual perform these tasks.***

***Failure to do so could result in electric shock or death.***

## **WARNING**

***Fire hazard.***

***Maintain minimum 1/4" clearance between the supply flange and combustible materials.***

***Failure to do so could result in fire causing damage, injury or death.***

## **WARNING**

***Heavy item hazard.***

***Use more than one person to handle unit.***

***Failure to do so could result in unit damage or serious injury.***

## **CAUTION**

***Cut hazard.***

***Wear gloves to avoid contact with sharp edges.***

***Failure to do so could result in personal injury.***

# USING THE TEC-EYE™

**FIGURE 1**  
TEC-EYE (Bard P/N 8301-059) Display and Interface (Status Screen Shown)



**ALARM KEY**

Allows viewing of active alarms  
Silences audible alarms  
Resets active alarms

**MENU KEY**

Allows entry to Main Menu

**ESCAPE KEY**

Returns to previous menu level  
Cancels a changed entry

**UP KEY**

Steps to next screen in the display menu  
Changes (increases) the value of a modifiable field

**ENTER KEY**

Accepts current value of a modifiable field  
Advances cursor

**DOWN KEY**

Steps back to previous screen in the display menu  
Changes (decreases) the value of a modifiable field

## TEC-EYE Hand-Held Service Tool

The TEC-EYE service tool is used to communicate with the FUSION-TEC unit logic board. By connecting directly to the logic board inside the unit control panel, it is possible to perform diagnostics on the unit, adjust certain settings and verify unit and economizer operation through a run test procedure. **The TEC-EYE service tool is required for unit setup and operation.** The TEC-EYE is supplied with the LV1000 controller but can also be ordered separately (Bard P/N 8301-059).

The menu driven interface provides users the ability to scroll through two menu levels: Quick Menu and Main Menu. The menus permit the user to easily view, control and configure the unit.

The controller is completely programmed at the factory; the default setpoints and their ranges are easily viewed and adjusted from the TEC-EYE display. The program and operating parameters are permanently stored on FLASH-MEMORY in case of power failure.

The TEC-EYE connects to the wall-mount unit control board via an RJ11 modular phone connector as shown in Figure 2.

When not being used, the TEC-EYE hand-held diagnostic tool should be stored inside or near the LV1000 controller. Do not let the TEC-EYE leave the shelter site.

**FIGURE 2**  
TEC-EYE Connection to Unit Control

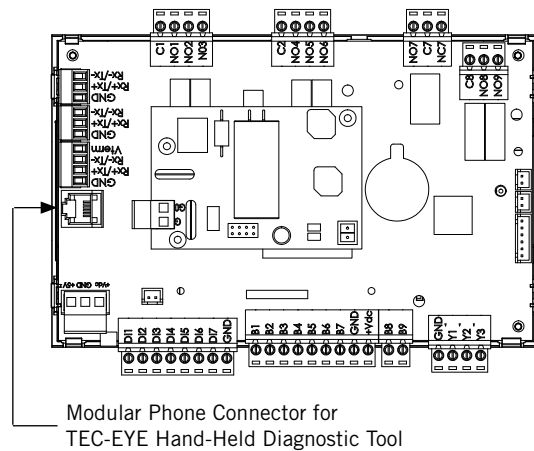

**TABLE 1**  
LV1000/TEC-EYE Passwords (Defaults)

User	2000
Technician	1313
Engineer	9254
Use UP or DOWN keys and ENTER key to enter password	

## TEC-EYE Screen Structure and Password Level

### Quick Menu

- Setpoints (Stand Alone Temperature Control)
- Information
- Alarm Log

### Main Menu

- System Config: A1-A10 User (2000)
- Adv Sys Config: B1-B5 Technician (1313)
- I-O Config: C1-C16 Technician (1313)
- On/Off: User (2000)
- Alarm Logs: User (2000)
- Settings
  - Date/Time: Technician (1313)
  - Language: User (2000)
  - Import/Export
    - Parameter Config: Engineer (9254)
    - Alarm Export: User (2000)
    - Trend Log Export: User (2000)
  - Initialization
    - Clear Logs: User (2000)
    - System Default: Engineer (9254)
    - Serial Ports: Technician (1313)
    - Change Passwords
- Logout

In addition to the menu structure above, there are also Status and Alarm screens.

### TEC-EYE Acronyms

- MAT – Mixed air temperature (calculated value)
- RAT – Return air temperature
- SAT – Supply air temperature
- OAT – Outdoor air temperature
- OAH – Outdoor air humidity
- ODP – Outdoor dew point (calculated value)
- Blower – Indoor blower speed
- Fan – Outdoor fan speed
- Damper – Free cooling damper position
- FC – Free cooling status
- CL1 – Compressor stage 1 status
- CL2 – Compressor stage 2 status
- H1 – Heater stage 1 status
- H2 – Heater stage 2 status
- ST – Number of start requests in last hour

**NOTE:** *Digital refers to On/Off whereas analog is a variable input.*

### Main Status Screen

The main Status screen is the default start-up screen and also the return screen after 5 minutes of no activity. The screen can be accessed at any time by pressing the ESCAPE key repeatedly.

The wall-mount unit address is displayed in the upper right corner on the main Status screen (see Figure 1). The main Status screen also shows the current date, time, return air temperature (RAT), mixed air temperature (MAT), supply air temperature (SAT) outdoor air temperature (OAT), outdoor air humidity (OAH) and outdoor dew point (ODP) conditions. Blower

speed, condenser fan speed, damper position and unit status are also displayed. See Table 2 for wall-mount unit status messages.

**TABLE 2**  
**Unit Status Messages**

Message	Description
Waiting...	PLC is on and has not started running the application yet.
Stand Alone	Unit is on and in orphan mode with no calls for heating or cooling.
LV Online	Unit is on and communicating with the LV1000 with no heating or cooling calls.
Cont. Blower	Unit is operating with continuous blower when no heating or cooling calls are present.
Power Loss	Unit has experienced a loss of main utility power. Alarm only available with inverter units.
Freecooling	Unit is actively economizing.
Optimized Cool	Unit is mechanical cooling while actively economizing.
Cooling	Unit is actively mechanical cooling.
Heating	Unit is actively heating.
Passive Dehum	Unit is taking measures to decrease humidity without using extra energy.
Active Dehum	Unit is taking active measures to decrease humidity.
Self Test	Unit is performing a self test.
Off by Alarm	Unit has major fault preventing operation.
Off by DI	Unit is disabled by the local unit disable/smoke input.
Off by LV	Unit has been turned off by the supervisory controller.
Off by Keyboard	Unit has been turned off by the local user.
Override Active	There is an active override on the system.
Emergency Vent	Unit is in Emergency Ventilation. LV1000 has an active hydrogen alarm.
Emergency Cool	Unit is in Emergency Cooling. Indoor temperatures have exceeded high temp alarms.
Emergency Off	Unit is in Emergency Off. LV1000 has an active smoke alarm.

The Quick Menu is accessible from the main Status screen. Setpoints, Information and Alarm Log are available through the Quick Menu. Pressing the UP or DOWN keys while on the main Status screen will change the Quick Menu icon displayed (see Figure 3). Press the ENTER key when the desired icon is displayed.

**FIGURE 3**  
Quick Menu Icons



**NOTE:** Screenshots shown in this manual reflect default settings (when applicable).

**Quick Menu**

**Setpoints**

From this screen, the local unit heating and cooling setpoints, used for stand alone operation only, can be changed.

Once the supervisory controller is connected, cooling and heating setpoints will be communicated and local cooling and heating setpoints will be replaced with the communicated cooling and heating setpoints.

If at any time the wall-mount unit(s) loses communication with the LV1000 controller, the wall-mount unit(s) will go into stand alone mode and operate using the last communicated setpoints.

To verify or change the wall-mount unit cooling and heating setpoints in stand alone mode:

1. Connect the TEC-EYE diagnostic tool to the control board located in the unit.
2. From the Status screen, press UP or DOWN key until Quick Menu displays Setpoints icon. Press ENTER key.
3. Press ENTER key to scroll to the selected choice (see Figure 4).

**FIGURE 4**  
Cool and Heat Setpoints

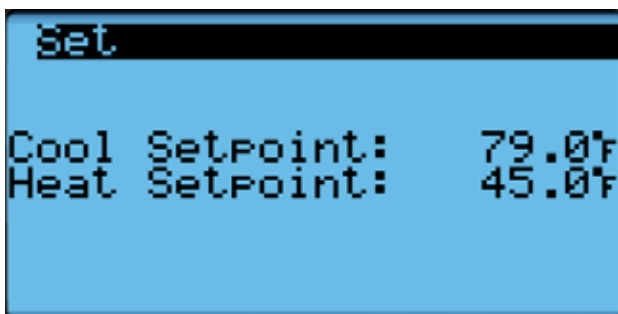

4. Press UP or DOWN key on desired value until value displays correctly.
5. Press ENTER key to save and scroll to next parameter.
6. Press ESCAPE key until Main Menu screen is displayed.

**Information**

The information screens are used as a quick reference to show unit operational information such as staging, A/C circuit measurements, last 24 hour run times, component lifetime hours and software versioning.

*Staging Information*

Staging information is used to show any unit operation that should be taking place. The look of the staging display depends on if the unit is communicating with a supervisory controller.

*Stand Alone Demand and Staging*

If the unit is operating in a stand alone mode, the title will display as **Unit Demand** (see Figure 5). This signifies that the local unit has control of the unit heating and cooling stages.

**FIGURE 5**  
Stand Alone Demand and Staging



*Master Staging*

If the unit is communicating with a supervisory controller, the title will display as **Master Staging** (see Figure 6). This signifies that the supervisory controller has control of the unit heating and cooling stages.

**FIGURE 6**  
Master Staging

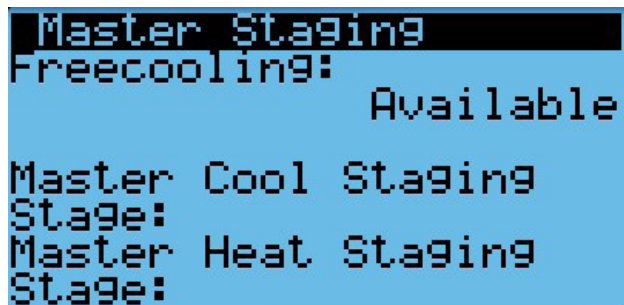



### A/C Circuit Measurements

A/C Circuit Information can be found in two screens within the information menu (see Figure 7). The information and measurements provided are liquid line temperature, liquid line pressure, condensing saturated temperature, suction line temperature, suction line pressures, suction saturated temperature, super heat, sub-cooling and electronic expansion valve position.

**FIGURE 7**  
A/C Circuit Measurements

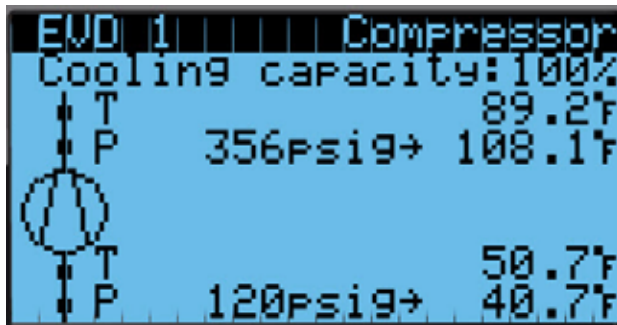

### Last 24 Hour Operation

Last 24 Hour Operation information tracks the runtimes (**Time**) and start calls (**Start**) of different components or operations in the last 24 hour period (see Figure 8).

**FIGURE 8**  
Last 24 Hour Operation

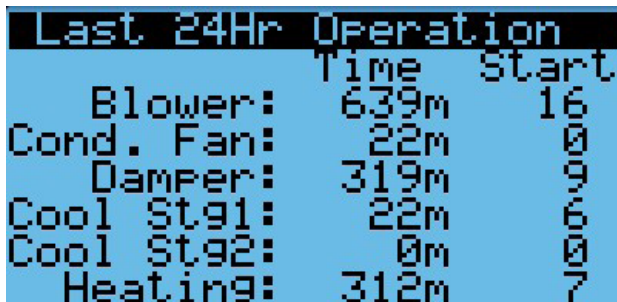

### Software Version

The Software Version screen displays the model number of the unit as well as all software version information for the PLC (see Figure 9). This information can be used to determine whether a software update may be required based on information found in the software change log. This change log can be found at <http://www.bardhvac.com/software-download/>.

**FIGURE 9**  
Software Version

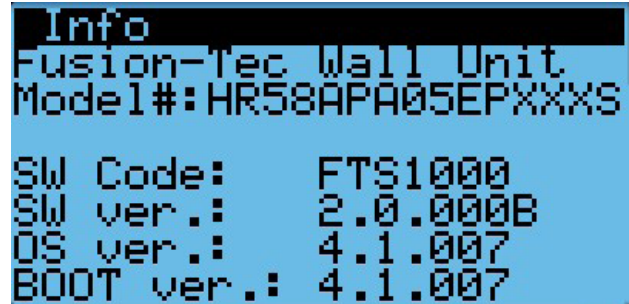

## NOTICE

*It is important to check the software version during installation to ensure that the latest version has been installed. Current software versions, change log and installation instructions are available on the Bard website at <http://www.bardhvac.com/software-download/>*

### Alarm Log

The alarm log screens show a log of each alarm. There will be a log for when alarm occurred and if the alarm auto clears, it will show when the alarm cleared.

### Addressing Wall-Mount Units

Each unit must have a unique address for the system to operate correctly with the LV controller (Ex: 1, 2, 3, 4 depending on the number of units). The wall-mount unit address is displayed in the upper right corner on the Status screen on the TEC-EYE display (see Figure 1 on page 6).

To change the unit address:

1. Press MENU key to access the Main Menu screen.
2. Press UP or DOWN keys and ENTER key to enter TECHNICIAN password 1313.
3. Press UP or DOWN keys to scroll to **Sys Config**; press ENTER key.
4. Press UP or DOWN keys to scroll to **Unit Setup (A1)** screen.
5. Press ENTER key to scroll to **Controller Address** (see Figure 10).
6. Press UP or DOWN keys to change the address to a value between 1 and 4.
7. Press ENTER key to save

**FIGURE 10**  
Changing Unit Address

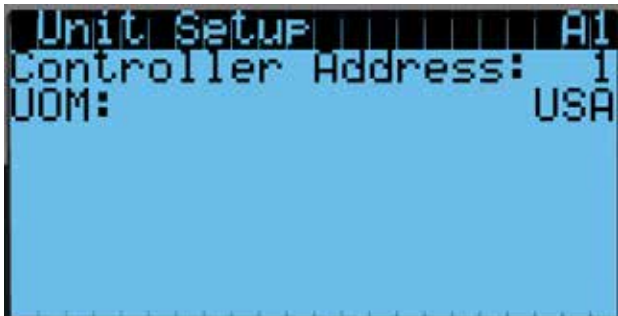

### Executing a Run Test

This unit has the ability to perform a run test that will operate all available unit functions in order to quickly determine unit operation. Some unit parameters are adjustable.

To execute a run test:

1. Press MENU key to access the Main Menu screen.
2. Press UP or DOWN keys and ENTER key to enter TECHNICIAN password 1313.
3. Press UP or DOWN keys to scroll to **Sys Config**; press ENTER key.
4. Press UP or DOWN keys to scroll to **Run Test (A10)** screen.
5. Press ENTER key to scroll to **Run Test Enable** parameter (see Figure 11).

6. Press UP or DOWN key to change value to ON. The run test will begin and the screen will change to **Run Test Summary**.

**FIGURE 11**  
Executing Run Test

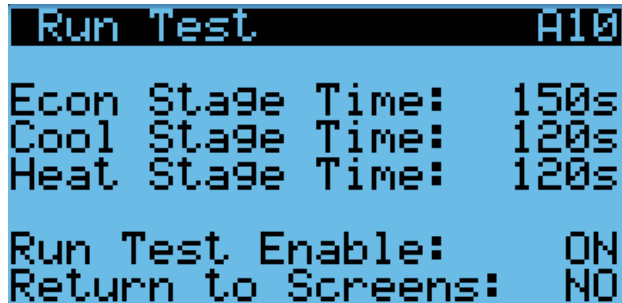

7. Press UP or DOWN key to scroll between **Run Test Summary, Motors & Sensors** and **A/C Circuit** screens.

**NOTE:** If the Run Test screens have been exited out of, they can be returned to by navigating to **Run Test (A10)** as provided in the instructions above, pressing ENTER key to scroll to **Return to Screens**, pressing UP or DOWN key to change value to YES and pressing ENTER key.

The **Run Test Summary** screen (Figure 12) contains a readout of the test that is currently taking place, and the Task the technician should be completing to verify operation.

**FIGURE 12**  
Run Test Summary

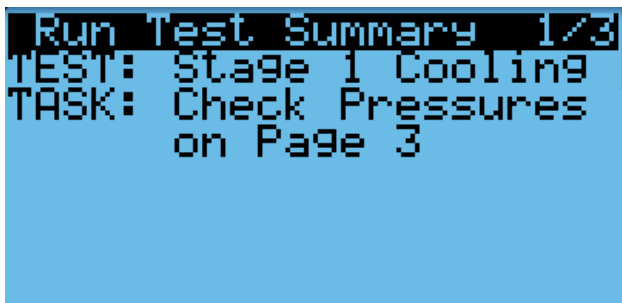

The **Motors & Sensors** screen (Figure 13) displays output and estimated positional values for unit motors and actuators, and also temperature and humidity sensor values.

**FIGURE 13**  
Run Test: Motors & Sensors

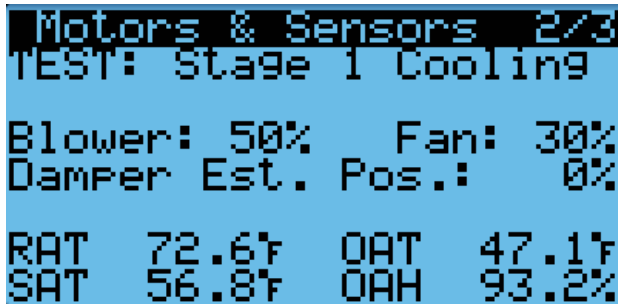

The **A/C Circuit** screen (Figure 14) displays all unit inputs, outputs and calculations associated with the A/C circuit operation.

**FIGURE 14**  
Run Test: A/C Circuit

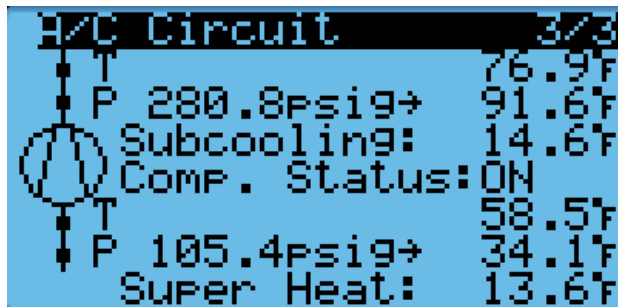

**Run Test Parameter Descriptions**

Econ Stage Time: Amount of time (in seconds) allowed for damper blade movement in each direction.

Cool Stage Time: Amount of time (in seconds) allowed for each stage of cooling.

Heat Stage Time: Amount of time (in seconds) allowed for heating stage.

**Reset to Factory Defaults**

To reset to factory default settings:

1. Press MENU key to go to the Main Menu screen.
2. Use UP or DOWN keys and ENTER key to enter ENGINEER password 9254.
3. Press UP or DOWN keys to scroll to **Settings**; press ENTER key.
4. Press UP or DOWN keys to scroll to **Initialization**; press ENTER key.
5. Press UP or DOWN keys to scroll to the **Default Installation** screen; press ENTER key.
6. Press ENTER key to scroll to **Reset to Factory Defaults** (see Figure 15).

7. Press UP or DOWN key to change value to **YES**; press ENTER key.
8. System will restart with default values.

**FIGURE 15**  
Restoring Factory Default Settings



# OPERATION

**NOTE:** Screenshots shown in this manual reflect default settings (when applicable).

## Unit On/Off

The wall-mount unit can be turned on and off from the TEC-EYE. Turning the unit off with the following instructions will disable all unit operation.

To turn the unit on or off:

1. Press MENU key to go to the Main Menu screen.
2. Press UP or DOWN keys and ENTER key to enter USER password 2000.
3. Press UP or DOWN keys to scroll to **On/Off**; press ENTER key.
4. Press UP or DOWN keys to change value from On to Off or from Off to On.
5. Press ESCAPE key several times to return to Main Menu screen.

The wall-mount unit may also be turned off by certain alarms such as the smoke alarm input on the wall-mount unit board or the return air temperature sensor failure when not connected to the LV1000.

## Alarm Adjustment

### Acknowledging Alarms

Alarm conditions activate a red LED indicator that backlights the ALARM function key. As an option, an alarm condition may also be enunciated by an audible alarm signal. An alarm is acknowledged by pressing the ALARM key. This calls up alarm display screen(s) that provide a text message detailing the alarm condition(s).

### Clearing Alarms

Alarms can only be cleared after the alarm condition has been corrected. To clear a single alarm, press and hold the ALARM key for 3 seconds while viewing a specific alarm screen. To clear all alarms, navigate to the screen at the end of the alarm list (shown in Figure 16) and press and hold the ALARM key for 3 seconds.

**FIGURE 16**  
Clearing All Alarms



## Clearing Alarm Logs and Counters

To clear the alarm log and alarm counters:

1. Press MENU key to go to the Main Menu screen.
2. Use UP or DOWN keys and ENTER key to enter USER password 2000.
3. Press UP or DOWN keys to scroll to **Settings**; press ENTER key.
4. Press UP or DOWN keys to scroll to **Initialization**; press ENTER key. (**Alarm Management** screen will be displayed.)
5. Press ENTER key to scroll to **Clear Alarm Logs?** (see Figure 17).
6. Press UP or DOWN key to change value to **YES**; press ENTER key.
7. Press ENTER key to scroll to **Clear Counters**.
8. Press UP or DOWN key to value to **YES**; press ENTER key.

**FIGURE 17**  
Clearing Alarm Logs and Counters

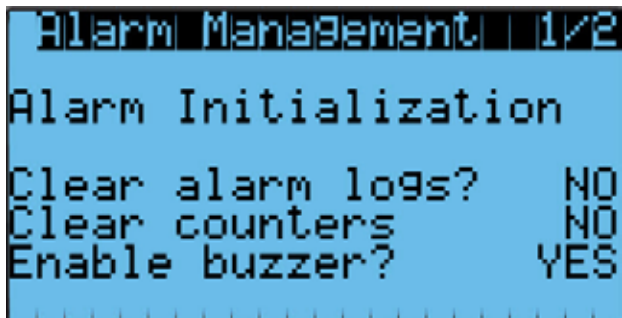

### Exporting Alarm Logs

See latest version of Supplemental Instructions manual 7960-815 for information on exporting alarm logs.

### Exporting 7 Day Logs

See latest version of Supplemental Instructions manual 7960-816 for information on exporting 7 day I/O logs.

## Stand Alone (Orphan) Mode

FUSION-TEC HR Series wall-mount units have the capability to run without the LV1000 controller attached—this feature is called stand alone or orphan mode. This keeps the shelter between 45°F and 79°F (factory default settings) by the use of the factory-installed return air sensor in each wall-mount unit. In stand alone mode, no auxiliary temperature measurement devices are required for operation. The wall-mount unit automatically uses a continuous blower setting to circulate room air into the return air inlet and

uses the return air temperature sensor to control room temperature.

To change default setpoints, refer to **Setpoints** on page 8.

During installation, the ability to run in stand alone mode allows deactivation of one of the existing, older wall-mount units, while keeping the shelter cool with the other unit still operating. Once the first of the Bard FUSION-TEC HR Series wall-mount units is installed and powered on, it will operate in orphan mode—keeping the climate inside the shelter stable and the installers comfortable while the remainder of the older equipment is removed and the remaining Bard FUSION-TEC HR Series wall-mount units and LV1000 controller are installed.

Additionally, should any or all of the FUSION-TEC HR Series wall-mount units lose communication with the LV1000 controller (such as during maintenance), they will continue to serve the shelter's needs until a repair can be made.

## Temperature/Humidity Control

### Temperature/Humidity Control Components

#### Return Air Temperature Sensor

The unit is equipped with a return air temperature sensor to monitor the space temperature when the unit is in stand alone mode. The return air sensor is located in the upper part of the return opening in such a way that it is exposed to the entering airstream. An alarm signal will be sent to the LV controller if the return air temperature sensor is disconnected. The temperature is measured with a 10k ohm NTC thermistor.

This sensor can be verified and adjusted by:

1. Press MENU key to go to the Main Menu screen.
2. Press UP or DOWN keys and ENTER key to enter TECHNICIAN password 1313.
3. Press UP or DOWN keys to scroll to **I/O Config**; press ENTER key.
4. Press UP or DOWN keys to scroll to **Return Air Sensor (C5)**; press ENTER key.
5. Verify the measurement displayed on screen is accurate (see Figure 18).
6. If the measurement needs to be adjusted, apply an offset value by pressing ENTER to scroll to **Offset**.
7. Press UP or DOWN keys to adjust the offset.
8. The update will not take effect until the cursor is moved out of the **Offset** parameter.
9. Once adjusted, press the ESCAPE key several times to return to Main Menu screen.

**FIGURE 18**  
**Adjusting Return Air Sensor**



#### Return Air Temperature Alarm

When the return air temperature sensor value is out of range (-41.0 to 303.0°F), the controller will generate a sensor failure alarm to indicate the sensor is not working properly.

This alarm is fixed and cannot be adjusted.

### Temperature/Humidity Control Operation

The unit utilizes a PID control loop for space control. This control will compare the space temperature to the space setpoint. Based on how far away from the setpoint the temperature is, the loop will output a cooling or heating capacity number between 0 and 100%. The unit will then take all of the available cooling methods and distribute them evenly across the 0-100% range. The stages are then brought on as the heating or cooling capacity reaches the percentage that brings the stages on or off. There are separate setpoints for cooling and heating.

To change or view the unit setpoint:

1. From the Status screen, press UP or DOWN key until Quick Menu displays Setpoints icon (  ). Press ENTER key.
2. Press ENTER key to scroll to **Cool Setpoint** or **Heat Setpoint** (see Figure 4 on page 8).
3. Press UP or DOWN keys to change the value to desired heating and/or cooling setpoint.

#### Cooling

The unit is equipped with 1 stage of freecooling and 2 stages of mechanical cooling (compressor and solenoid) for a total of 3 cooling stages (see Figure 19 on page 14).

#### Cooling w/No Economizer

The unit is equipped with 1 stage of freecooling and 2 stages of mechanical cooling (compressor and solenoid). However, the outdoor conditions are not favorable for economizer operation so there are a total of 2 cooling stages (see Figure 20 on page 14).

**FIGURE 19**  
Cooling w/Economizer

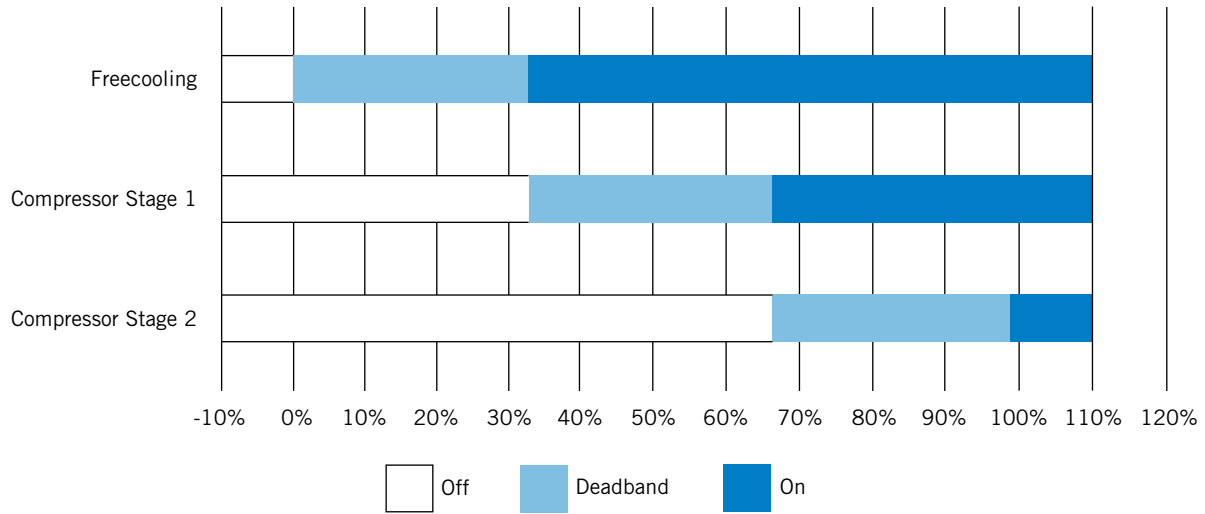

Deadband (sometimes called a neutral zone or dead zone) is an interval of a signal domain or band where no action occurs

**FIGURE 20**  
Cooling w/No Economizer

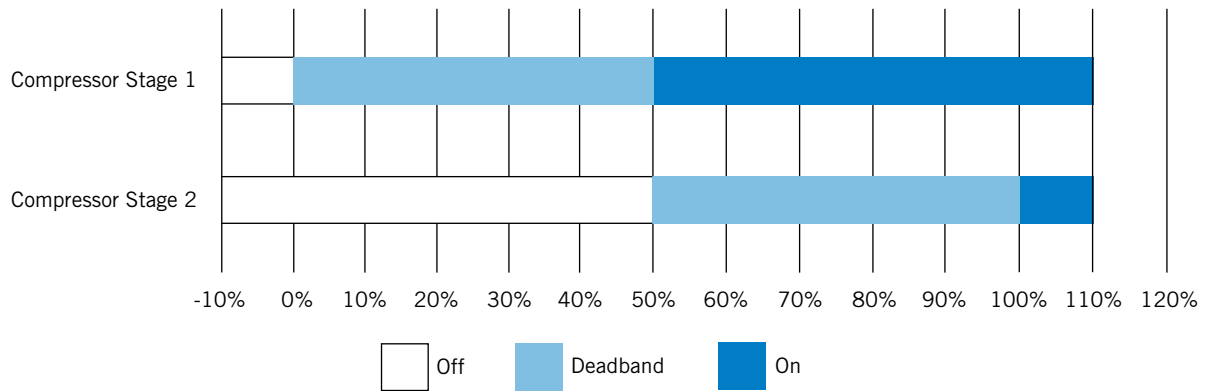

Deadband (sometimes called a neutral zone or dead zone) is an interval of a signal domain or band where no action occurs

**FIGURE 21**  
Heating

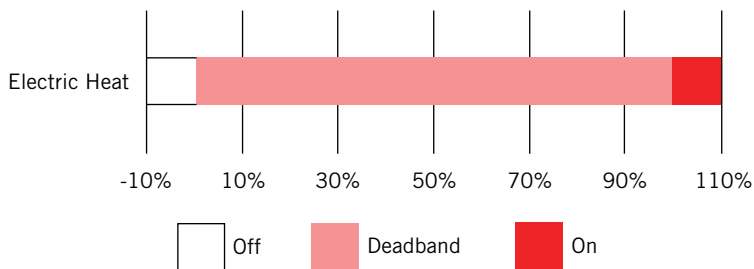

Deadband (sometimes called a neutral zone or dead zone) is an interval of a signal domain or band where no action occurs

## Heating

The unit is equipped with 1 stage of electric heat (see Figure 21).

## Staging

The unit will stage the cooling components based on the cooling demand referenced in the temperature control. The unit will stage the economizer on first if the indoor and outdoor conditions are favorable. The compressor stage 1 will be enabled next as the demand increases. Finally, the compressor stage 2 will be enabled as the demand continues to increase.

The unit is only equipped with one stage of heat and will turn on based on the heating demand.

To view unit stages:

1. From the Status screen, press UP or DOWN key until Quick Menu displays Unit Information icon (  ). Press ENTER key.
2. The cooling and heating demand are visible on this screen. The unit stages will display here when active as FC, CL1, CL2 or H1 (see Figure 22).

**FIGURE 22**  
Viewing Unit Stages



## Dehumidification

The unit uses a dehumidification sequence that does not require the electric heat to run at the same time as the compressor. Instead, the unit will turn on the compressor to cool down to the heating setpoint. Once the lower setpoint has been reached, the unit will heat the space back up to the upper setpoint. This cycle continues until the humidity level in the shelter reaches an acceptable level. At this point, the unit will revert back to normal operation. The economizer will also be disabled while the unit is in the dehumidification mode.

**NOTE:** This feature is dependent upon the LV1000 indoor humidity sensors and a command from the LV to enter dehumidification mode. See the latest revision of LV1000 Service Instructions 2100-673 for adjustment of the dehumidification setpoint and differentials.

## Electronic Expansion Valve (EEV)

### EEV Components

#### Electronic Expansion Valve

The electronic expansion valve is a stepper motor that is controlled with a step output from the controller. The valve is capable of 480 steps represented by a 0-100% signal on the controller. The motor drives a needle valve that regulates the flow of refrigerant.

#### EEV Instructions for Vacuum, Reclaim, Charge Unit

The electronic expansion valve moves to the 20% open position when the unit is not actively cooling. The valve may need to be manually positioned for service or troubleshooting. The valve can be positioned by using a menu override.

To manually override the valve:

**NOTE:** The unit must be off to perform this override.

1. Press MENU key to go to the Main Menu screen.
2. Press UP or DOWN keys and ENTER key to enter TECHNICIAN password 1313.
3. Press UP or DOWN keys to scroll to **I/O Config**; press ENTER key.
4. Press UP or DOWN keys to scroll to **TEEV Service (C16)**; press ENTER key.
5. Press ENTER key to scroll to **Enable** (see Figure 23).
6. Press UP or DOWN key to change **Disable** to **Enable**.
7. Press ENTER key to scroll to **Position**.
8. Press UP or DOWN keys to adjust to the desired value.
9. Press ENTER key to save.

**FIGURE 23**  
Overriding EEV Output

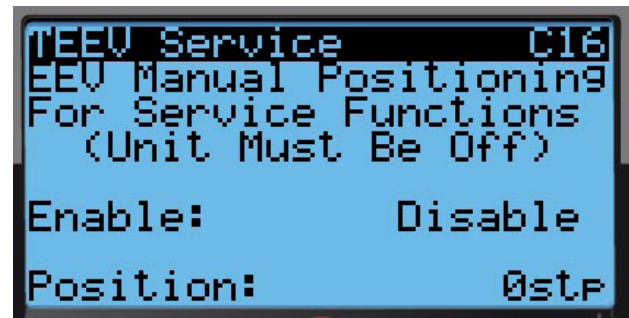

The valve can also be opened or closed using the EEV service tool (Bard Part # 2151-021). This magnetic EEV service tool (shown in Figure 24 on page 16) is used to manually open the EEV. To do this, remove the EEV stator coil (red color with retaining nut on top), slide the magnetic tool over the shaft where the stator was removed and turn in a clockwise direction to open the valve to the full open position (directional arrows

**FIGURE 24**  
**Electronic Expansion Valve (EEV) and Service Tool**

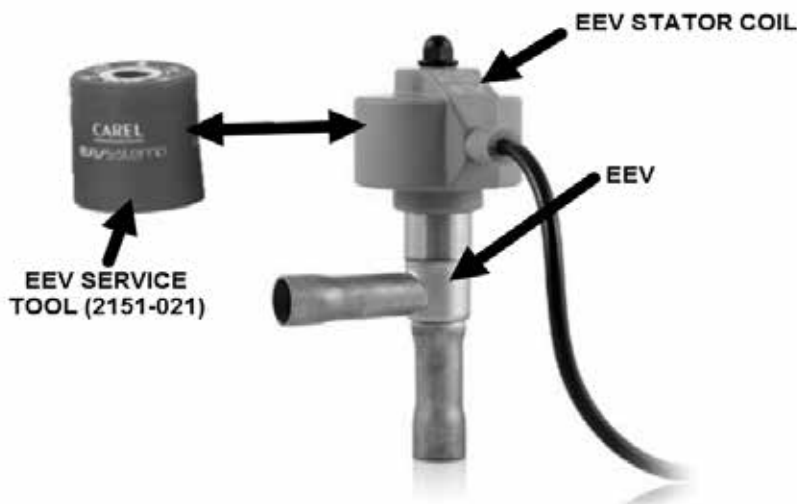

are provided on the tool). Opening the valve to the full open position will aid in the refrigerant reclamation and evacuation processes.

With the stator removed, the resistance should be 40 ohms +/- 10%. There are two sets of three wires that will have this resistance.

Reapply the EEV stator coil and retaining nut. Upon powering the unit back up, the control board will automatically drive the EEV back to the fully shut position, and then back to the 20% open position prior to starting the compressor back up. Once the compressor starts, the control board will again modulate the EEV position to control the system superheat.

### **System Pressures**

To view system pressure and temperatures during this process:

1. From the Status screen, press UP or DOWN key until Quick Menu displays Information icon (  ). Press ENTER key.
2. Press UP or DOWN keys to scroll to **EEV 1 Circuit** and **EVD 1 Compressor** screens.
3. Reference the **Pressures** and **Temperatures** on **EVD 1 Compressor** and the **Superheat** and **Subcooling** on **EEV 1 Circuit**.

### **Suction Pressure Transducer**

The unit has a pressure transducer installed on the suction line between the evaporator coil and compressor. The transducer is used for system monitoring of suction system pressures. The sensor is used with the suction temperature sensor to provide a real time superheat calculation that determines the EEV position.

This sensor can be verified and adjusted by:

1. Press MENU key to go to the Main Menu screen.
2. Press UP or DOWN keys and ENTER key to enter TECHNICIAN password 1313.
3. Press UP or DOWN keys to scroll to **I/O Config**; press ENTER key.
4. Press UP or DOWN keys to scroll to **Suction Pr Sensor (C11)**; press ENTER key.
5. Verify the measurement displayed on screen is accurate (see Figure 25).
6. If the measurement needs to be adjusted, apply an offset value by pressing ENTER to scroll to **Offset**.
7. Press UP or DOWN keys to adjust the offset.
8. The update will not take effect until the cursor is moved out of the **Offset** parameter.
9. Once adjusted, press the ESCAPE key several times to return to Main Menu screen.

**FIGURE 25**  
**Adjusting Suction Sensor/Transducer Pressure Values**

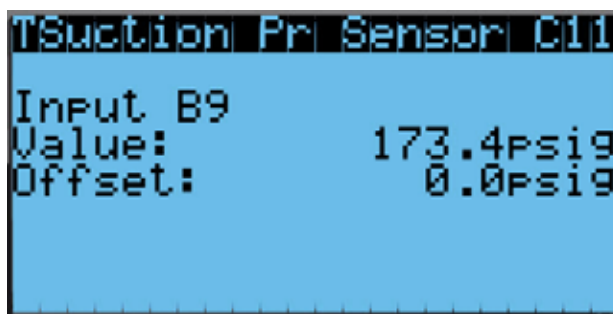



### Troubleshooting the Suction Pressure Transducer

0-250 psig

-5v Nominal .5 – 4.5v Actual

4v/250 psig = .016 volts per 1 psig

Example: 125 psig x .016 + .5 volts = 2.5 volts

Formula for Tech:

Measured Pressure x .016 + Sensor Offset = Expected Transducer Signal Voltage (see Figure 26).

FIGURE 26

### Voltage to Pressure: Suction Pressure Transducer

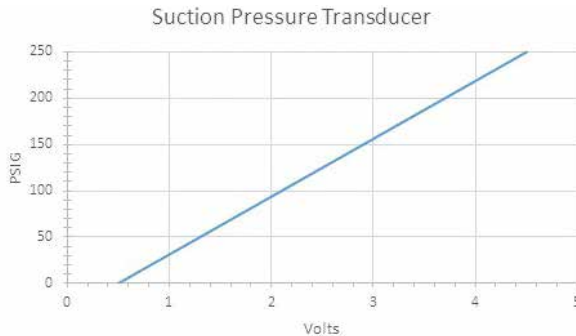

### Suction Pressure Alarm

When the suction pressure transducer value is out of range (0-250 PSIG), the controller will generate a sensor failure alarm to indicate the sensor is not working properly.

This alarm cannot be adjusted.

### Suction Temperature Sensor

The suction temperature sensor is used to calculate superheat. The EEV uses this value to control the EEV. The temperature is measured with a 10k ohm NTC thermistor.

The suction temperature sensor measurement can be verified and adjusted by:

1. Press MENU key to go to the Main Menu screen.
2. Press UP or DOWN keys and ENTER key to enter TECHNICIAN password 1313.
3. Press UP or DOWN keys to scroll to **I/O Config**; press ENTER key.
4. Press UP or DOWN keys to scroll to **Suct Temp Sensor (C9)**; press ENTER key.
5. Verify the measurement displayed on screen is accurate (see Figure 27).
6. If the measurement needs to be adjusted, apply an offset value by pressing ENTER to scroll to **Offset**.
7. Press UP or DOWN keys to adjust the offset.
8. The update will not take effect until the cursor is moved out of the **Offset** parameter.

FIGURE 27

### Adjusting Suction Temperature Sensor Values

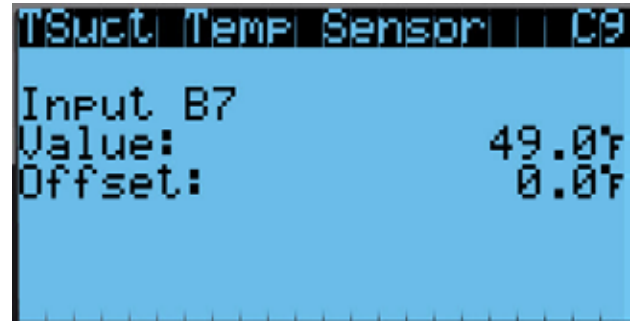

### Suction Temperature Alarm

When the suction temperature sensor value is out of range (-41.0 to 303.0°F), the controller will generate a sensor failure alarm to indicate the sensor is not working properly.

This alarm cannot be adjusted.

### Evaporator Freeze Condition Alarm

The FUSION-TEC Freeze alarm (Evaporator Coil Freeze Protection) uses the suction temperature sensor to alarm and manage operation when conditions are favorable for an evaporator coil freeze condition. Whenever the compressor is running, the system will constantly monitor the suction line temperature. If the suction line temperature falls below the freeze setpoint (33°F factory default) for a period of time exceeding freeze alarm delay time (180 seconds factory default), the system will alarm a freeze condition. Once a freeze condition is triggered, the system will stop the compressor operation and increase the blower speed to 80% in order to rapidly warm and thaw the evaporator coil. After a period of 5 minutes has elapsed, normal operation will continue.

To adjust the freeze setpoint and/or alarm delay time:

1. Press MENU key to go to the Main Menu screen.
2. Press UP or DOWN keys and ENTER key to enter USER password 2000.
3. Press UP or DOWN keys to scroll to **System Config**; press ENTER key.
4. Press UP or DOWN keys to scroll to **Alarm Setup (A7)**; press ENTER key.
5. Press ENTER key to scroll to **Setpoint** (see Figure 28 on page 18).
6. Press UP or DOWN keys to change to the desired value.
7. Press ENTER key to save the value/scroll to **Delay**.
8. Press UP or DOWN keys to change to the desired **Delay** value.
9. Press ENTER key to save the value.

**FIGURE 28**  
**Adjusting Freeze Setpoint and Alarm Delay**



**EEV Operation**

**EEV Superheat Control**

The electronic expansion valve (EEV) will open or close to maintain 10° of superheat while the compressor is running. When the compressor is not running, the valve will close.

Low superheat protection will be active once the superheat value is at or below 5°F. At this point, the control will aggressively close the valve so that superheat is maintained.

**Additional EEV Alarms**

**Low Superheat Alarm**

This alarm will become active when the calculated superheat goes below 5°F. This alarm will clear itself when the condition is no longer present.

This alarm cannot be adjusted.

**Indoor Airflow**

**Indoor Airflow Components**

**Blower**

The unit is equipped with a blower that is driven by an electronically commutated motor (ECM). This blower is controlled by a 0-10v signal provided from the controller. This 0-10v signal is converted to a PWM signal with an adapter. The blowers on both the HR36AP\* and HR58AP\* models use a 10" diameter wheel. The HR36AP\* operates between 250-850 rpm while the HR58AP\* operates between 250-1400 rpm.

The blower output can be put into an override mode for verification or troubleshooting.

To put the blower into override:

1. Press MENU key to go to the Main Menu screen.
2. Press UP or DOWN keys and ENTER key to enter TECHNICIAN password 1313.
3. Press UP or DOWN keys to scroll to **I/O Config**; press ENTER key.
4. Press UP or DOWN keys to scroll to **Blower Fan (C13)**; press ENTER key.

5. Press ENTER key to scroll to **Blower OV Speed** (see Figure 29).
6. Press UP or DOWN keys to adjust the speed to the desired output (see Table 3A or 3B).
7. Press ENTER key to scroll to **Override**.
8. Press UP or DOWN key to change **Disabled** to **Enabled**.
9. Press ENTER key to save.

**FIGURE 29**  
**Putting Blower Output into Override Mode**



**TABLE 3A**  
**HR36AP\* Blower Speeds**

Mode	Speed Percentage	Controller Output Volts	CFM
Freezestat Active	94.0	9.4 v	1500
High Sensible Full Load Cooling	94.0	9.4 v	1500
High Sensible Part Load Cooling	54.0	5.4 v	1100
Standard Full Load Cooling	63.0	6.3 v	1200
Standard Part Load Cooling	43.0	4.3 v	950
Economizer Standard	90.0	9.0 v	1450
Economizer High S/T	63.0	6.3 v	1200
Heating	63.0	6.3 v	1200
Dehumidification Mode	19.0	1.9 v	470

**TABLE 3B**  
**HR58AP\* Blower Speeds**

Mode	Speed Percentage	Controller Output Volts	CFM
Freezestat Active	80.0	8.0 v	2260
High Sensible Full Load Cooling	75.0	7.5 v	2180
High Sensible Part Load Cooling	50.0	5.0 v	1705
Standard Full Load Cooling	55.0	5.5 v	1830
Standard Part Load Cooling	35.0	3.5 v	1335
Economizer Standard	45.0	4.5 v	1600
Economizer High S/T	75.0	7.5 v	1950
Heating	35.0	3.5 v	1335
Dehumidification Mode	35.0	3.5 v	1335

**TABLE 4**  
**Rated Airflow**

	Nominal Rated CFM		Nominal Rated ESP
	High	Low	
HR36AP*	1200	950	0.00
HR58AP*	1800	1400	0.10

**TABLE 5**  
**Indoor Blower Performance**

	Speed	High		Low	
	ESP (Inch H <sub>2</sub> O)	Dry Coil	Wet Coil	Dry Coil	Wet Coil
HR36AP*	0.00	1260	1200	995	950
HR58AP*	0.10	1885	1800	1470	1400

**TABLE 6**  
**Maximum ESP of Operation**  
**Electric Heat Only**

Model	Static Pressure*
-A0Z	.00"
-A05	.00"
-B0Z	.00"
-B06	.00"

\* Unit is rated for free blow non-ducted operation with SGR-5W Supply Grille and RGR-5W Return Grille.

**Blower Status Switch**

The unit is equipped with a differential pressure airflow switch to monitor the blower (see Figure 30). If the blower is turned on and the switch doesn't open to indicate there is differential pressure between the inlet and outlet of the blower, an alarm will be generated. For switch settings, see Figure 30.

**FIGURE 30**  
**Dirty Filter Switch and Blower Status Switch**

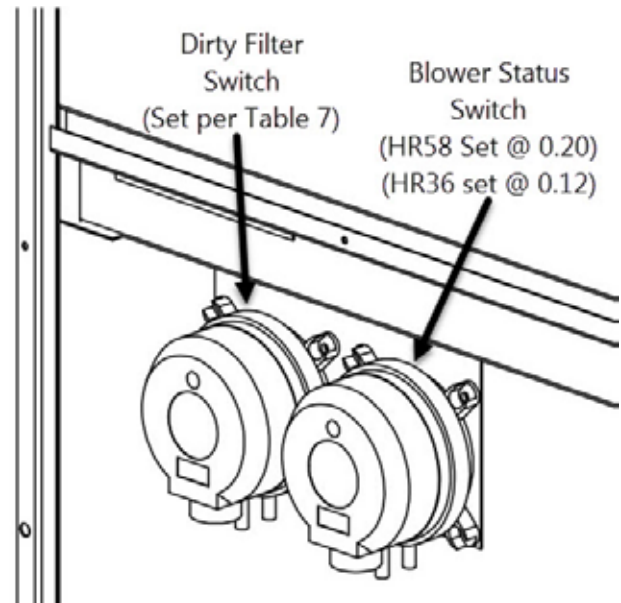

Differential airflow status can be viewed by:

1. Press MENU key to go to the Main Menu screen.
2. Press UP or DOWN keys and ENTER key to enter TECHNICIAN password 1313.
3. Press UP or DOWN keys to scroll to **I/O Config**; press ENTER key.
4. Press UP or DOWN keys to scroll to **Digital In Config (C2)**; press ENTER key.
5. Reference **7 NoAir** row and **Val** column (see Figure 31).

**FIGURE 31**  
**Verifying Differential Airflow Status**

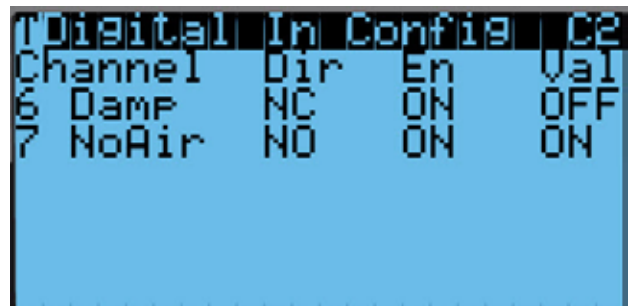

### **Blower Status Alarm**

If the blower is commanded on and the fan status switch (differential pressure) has not indicated the fan is running within 45 seconds, the system will generate an alarm.

Disabling the blower status switch in **I/O Config** disables this alarm.

This alarm is just a notification and will clear itself when the conditions are no longer present.

To adjust the air flow alarm delay:

1. Press MENU key to go to the Main Menu screen.
2. Press UP or DOWN keys and ENTER key to enter USER password 2000.
3. Press UP or DOWN keys to scroll to **System Config**; press ENTER key.
4. Press UP or DOWN keys to scroll to **Alarm Setup (A8)**; press ENTER key.
5. Press ENTER key to scroll to **Air Flow Alarm Del** (see Figure 32).
6. Press UP or DOWN keys to change to the desired value.
7. Press ENTER key to save the value.

**FIGURE 32**  
**Adjusting Air Flow Alarm Delay**

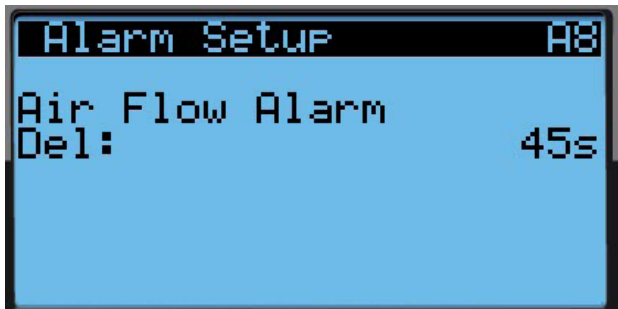

### **Filters**

The unit is equipped with two (2) 20" x 30" x 2" MERV 8 filters. The filters slide into position making them easy to service. The filters can be serviced from the outside by removing either the right or left filter access panel.

### **Dirty Filter Switch**

These units are equipped with a differential pressure switch to indicate when the filter(s) needs to be replaced (see Figure 30). The dirty filter switch measures the pressure difference across the filter through silicone tubing routed to the blower and vent areas of the unit.

The switch circuit consists of a *normally open* filter pressure switch. The switch will open when the pressure differential goes above the setting indicated

on the dial. When the pressure difference returns below the setting on the dial, the switch will close.

Adjustment of dirty filter switch may be necessary to ensure proper operation. See Table 7 and Figure 33 to aid in setting the filter switch to operate at different percentages of filter blockage.

### **Dirty Filter Alarm**

The wall-mount unit is equipped with a differential pressure switch input to the controller (see Figure 30). When the switch indicates a dirty filter, the controller will generate an alarm. Once the condition is no longer present, the alarm will automatically clear. Additionally, an indicator light will be turned on with the alarm and turned off when the alarm clears.

Disabling the dirty filter switch in **I/O Config** disables this alarm.

The threshold of this alarm is adjusted by changing the settings on the switch (see Table 7).

### **Filter Indicator Light**

These units are equipped with a 24v indicator light mounted on side of unit that displays the current status of the filter (as shown in Figure 33). When the light is on, the filter needs to be replaced. Once the filter(s) has been changed, the indicator light will turn off.

### **Freezestat**

Earlier units were equipped with a switch that monitored the temperature of the refrigerant line leaving the evaporator coil. To prevent the coil from freezing and potentially allowing liquid refrigerant from the evaporator to enter the compressor, the freezestat switch was designed to open when the temperature at this sensor is between 26.5°F and 37.5°F and close again when the temperature is between 49.5°F and 64.5°F. This switch was used in units running software version 1.0.4 and earlier and has been removed. The evaporator coil freeze protection alarm is now calculated using system temperatures (see **Evaporator Freeze Condition Alarm** on page 17).

### **Indoor Airflow Operation**

#### **Blower Speed Control**

The blower is capable of changing speeds to best match the requirements of the system depending on which mode the system is in (see Table 3A or 3B on page 19).

The unit will automatically switch to the required speed for each mode. High sensible mode and dehumidification mode are both communicated separately from the LV. For more information on the high sensible command from LV, please see LV1000 Service Instructions 2100-673.

**TABLE 7**  
**Filter Switch Pressure Settings**

Unit	Filter Blockage %	0%	10%	20%	30%	40%	50%	60%	70%
HR36AP* (Default) High S/T	Switch Static Setting	0.12	0.12	0.12	0.20	0.20	0.35	0.35	0.40
	Evaporator Airflow %	100%	99.3%	99.4%	98.7%	96.5%	92.1%	91.3%	87.9%
HR36AP* Standard Airflow	Switch Static Setting	0.12	0.12	0.12	0.12	0.20	0.20	0.20	0.30
	Evaporator Airflow %	100%	99.3%	99.4%	98.8%	97.3%	91.5%	89.8%	88.3%
HR58AP* (Default) High S/T	Switch Static Setting	0.40	0.50	0.60	0.70	0.75	0.80	0.90	1.00
	Evaporator Airflow %	100%	98.7%	98.1%	97.5%	91.7%	81.3%	79.1%	78.6%
HR58AP* Standard Airflow	Switch Static Setting	0.30	0.35	0.40	0.45	0.50	0.65	0.70	0.90
	Evaporator Airflow %	100%	99.8%	99%	98.5%	96.8%	89.9%	84%	82.2%

All units tested equipped with MERV 8 filters. Appropriate supply (SG) and return (RG) grilles installed during testing. Pressure switch adjustment may be necessary due to variations in filter type, installation and room pressure.

**Bard recommends filter switch be set at 50% filter blockage or less. Higher settings may significantly hinder unit performance.**

**FIGURE 33**  
**Dirty Filter Switch and Filter Indicator Light**

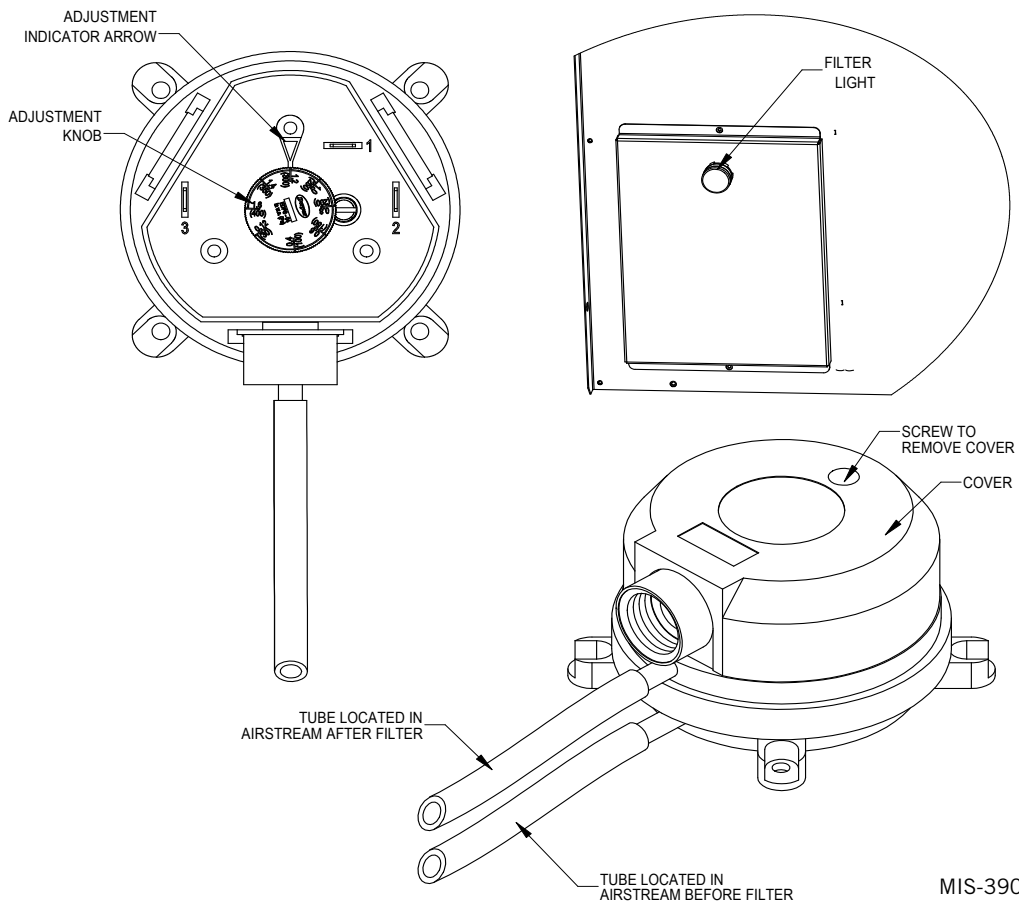

MIS-3901

## Additional Indoor Airflow Alarms

### Supply Air Temperature Alarm

When the supply air temperature sensor value is out of range (-41.0 to 303.0°F), the controller will generate a sensor failure alarm to indicate the sensor is not working properly.

This alarm is fixed and cannot be adjusted.

### Condenser Fan

#### Condenser Fan Components

##### Condenser Fan

The unit is equipped with a condenser fan that is driven by an electronically commutated motor (ECM). This fan is controlled by a 0-10vdc signal provided from the controller. The fan operates between 100-1200 rpm.

To view the output of the condenser fan:

1. Press MENU key to go to the Main Menu screen.
2. Press UP or DOWN keys and ENTER key to enter TECHNICIAN password 1313.
3. Press UP or DOWN keys to scroll to **I/O Config**; press ENTER key.
4. Press UP or DOWN keys to scroll to **Condenser Fan (C15)**; press ENTER key.
5. Reference **Fan Speed** parameter for the current output to the condenser fan (see Figure 34).

**FIGURE 34**  
Verifying Condenser Fan Output

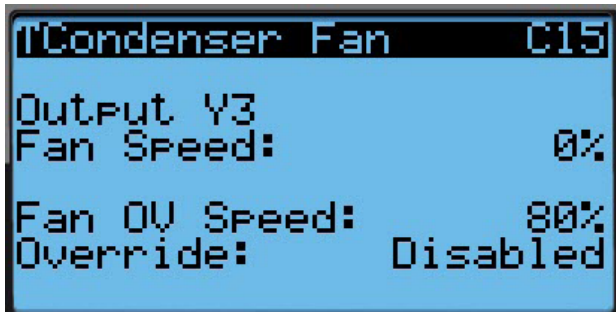

If required, the condenser fan output can be manually set for 5 minutes for troubleshooting purposes.

While looking at **Condenser Fan (C15)** screen:

1. Press ENTER key to scroll to **Fan OV Speed** (see Figure 36).
2. Press UP or DOWN keys to change the value to the desired override speed.
3. Press ENTER key to save the value and move cursor to the **Override** parameter.
4. Press UP or DOWN keys to change the value from **Disabled** to **Enabled**.

5. The fan should now run at the selected speed. The output can be verified by again referencing the **Fan Speed** parameter.

The override will last for 5 minutes or until the **Override** parameter is set to **Disabled** again.

Due to design considerations of the condenser section of the wall-mount unit, placement/clearance of the motor/fan blade is critical to heat dispersal. Should a change of motor or fan blade be necessary, see Figure 35 for proper clearance adjustment.

**FIGURE 35**  
Fan Blade Setting

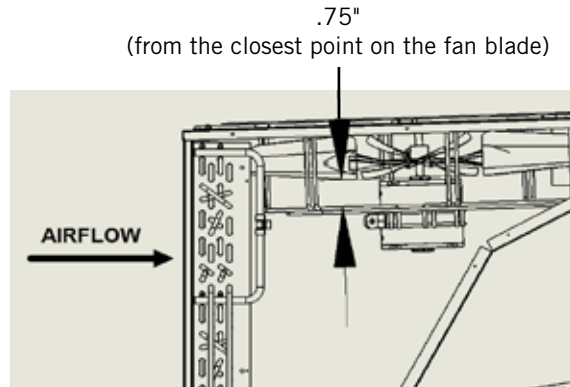

##### Liquid Line Pressure Transducer

The unit has a pressure transducer installed on the liquid line between the condenser and electronic expansion valve (EEV). The transducer is used for system monitoring of the liquid side system pressures. This information is used to indicate when outdoor coil cleaning is necessary based on outdoor conditions and system pressures. The sensor is also used to adapt the condenser fan speed for high and low ambient conditions.

The liquid pressure sensor input can be verified and adjusted by:

1. Press MENU key to go to the Main Menu screen.
2. Press UP or DOWN keys and ENTER key to enter TECHNICIAN password 1313.
3. Press UP or DOWN keys to scroll to **I/O Config**; press ENTER key.
4. Press UP or DOWN keys to scroll to **Liquid Pr Sensor (C10)**; press ENTER key.
5. Verify the measurement displayed on screen is accurate (see Figure 36).
6. If the measurement needs to be adjusted, apply an offset value by pressing the ENTER key to scroll to **Offset**.
7. Press UP or DOWN keys to adjust the offset. The update will not take effect until the cursor is moved out of the offset parameter.

- Once adjusted, the ESCAPE key several times to return to Main Menu screen.

**FIGURE 36**  
Adjusting Discharge/Liquid Transducer Pressure Values

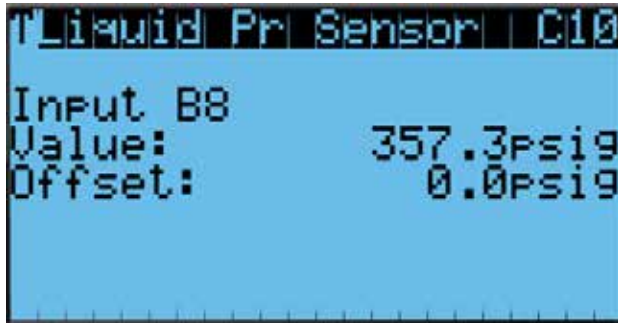

**Troubleshooting the Discharge/Liquid Pressure Transducer**

0-650 psig  
0-5vdc

$4v/650 \text{ psig} = .00615 \text{ volts per 1 psig}$

Example:  $325 \text{ psig} \times .00615 + .5 \text{ v} = 2.5 \text{ volts}$

Formula for Tech:

Measured Pressure x .00615 + Sensor Offset =  
Expected Transducer Signal Voltage (see Figure 37).

**FIGURE 37**  
Voltage to Pressure:  
Discharge/Liquid Pressure Transducer

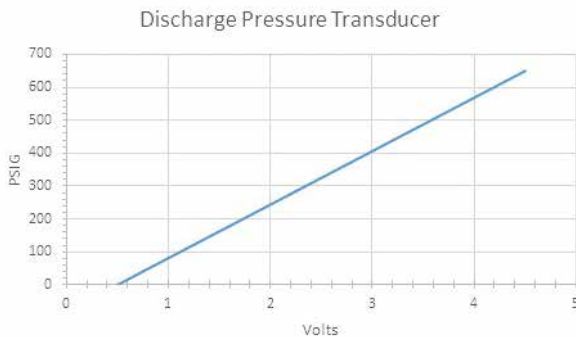

**Discharge/Liquid Pressure Transducer Alarm**

When the discharge pressure transducer value is out of range (0-650 PSIG), the controller will generate a sensor failure alarm to indicate the transducer is not working properly.

This alarm is fixed and cannot be adjusted.

**Liquid Temperature Sensor**

The unit is equipped with a liquid line temperature sensor to monitor the temperature of the liquid refrigerant leaving the condenser and entering the EEV. The temperature is measured with a 10k ohm NTC thermistor.

The liquid temperature sensor can be verified and adjusted by:

- Press MENU key to go to the Main Menu screen.
- Press UP or DOWN keys and ENTER key to enter TECHNICIAN password 1313.
- Press UP or DOWN keys to scroll to **I/O Config**; press ENTER key.
- Press UP or DOWN keys to scroll to **Liquid Temp Sensor (C3)**; press ENTER key.
- Reference the **Value** to verify the temperature (see Figure 38).
- If an offset needs to be applied, press ENTER key to scroll to **Offset**.
- Press UP or DOWN keys to change the offset to desired value.
- Press ENTER key to save.
- Press ESCAPE key several times to return to Main Menu screen.

**FIGURE 38**  
Adjusting Discharge/Liquid Temperature Input



**Condenser Fan Operation**

**Condenser Fan Speed Control**

**Mechanical Cooling Only**

The condenser fan motor speed is selected based on outdoor air temperature. Above 80°F, the fan speed will be set to a nominal output speed. Below 80°F, the condenser fan speed will operate at reduced speeds based on outdoor air temperatures until the slowest fan speed is reached. This operation allows for more stable head pressures at lower ambient conditions, which also allows for increased unit efficiency. See Figure 39 on page 24 for more detail.

**NOTE:** If the outdoor temperature sensor fails, the condenser fan speed will be set to the nominal operating speed.

**Optimized Cooling (Concurrent Economizer and Mechanical Cooling)**

During optimized cooling mode, the condenser fan motor speed will be set to the normal operating speed and will not change based on outdoor air conditions. If

**FIGURE 39**  
**Condenser Fan Speed Control**

Condenser Fan Output @ Ambient Outdoor Temperature

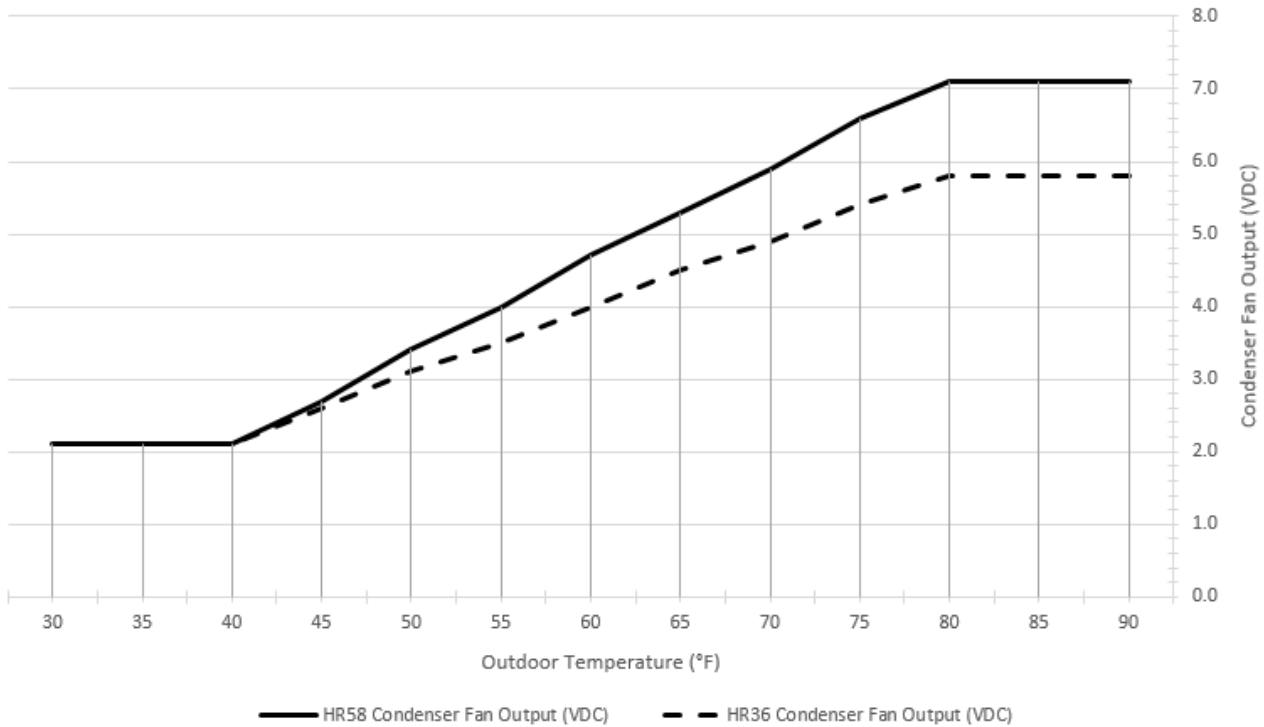

conditions become unfavorable for optimized cooling, the system will change to mechanical cooling only. When this occurs, the fan speed will remain at normal speed for 2 minutes, allowing for the damper blade to fully close. After the 2-minute period, the condenser fan speed may be reduced to optimize head pressures. During optimized cooling, all fan speed control will be handled by the low ambient controls and high pressure controls if system pressures were to get out of range.

**High Pressure Control**

**Condenser Fan Speed**

When the liquid pressure reaches 550 PSI, the condenser fan will speed up, moving as much air as possible in an attempt to reduce system pressures. The condenser fan will operate at increased speed until the liquid pressure reaches 450 PSI. At this point, the fan will return to normal operating speed.

**Second Stage Drop Out**

If the liquid pressure reaches 620 PSI, the second stage of cooling will be disabled for 2 minutes to reduce the required condenser airflow. After 2 minutes, if the pressure is less than the pressure cutout, it will resume stage 2 operation.

**Low Ambient Control**

At low ambient outdoor air temperatures, the fan motor will cycle as a means of controlling the system's head pressure to protect the system from evaporator coil freeze conditions. The process for this system is as follows: If the liquid pressure falls below 250 PSI, the condenser fan will turn off. The fan will remain off while the compressor remains running, allowing the head pressure to build up. Once the liquid pressure reaches 350 PSI, the fan will then turn back on at the appropriate speed. At lower ambient outdoor temperatures, this may cycle regularly as normal operation. In some cases, in higher wind prone areas, the condenser fan may stay off for prolonged durations due to low liquid pressures.

**Additional Condenser Fan Alarms**

**Dirty Condenser Coil Alarm**

The unit will continuously monitor system conditions to determine if the condenser coil is dirty or blocked. If the system monitors three consecutive cooling cycles that indicate a dirty condenser coil, an alarm will be generated. This alarm is a notification and will automatically reset when conditions are no longer present. The end user has the ability to adjust how



dirty the coil gets before an alarm is generated and how many consecutive cycles before the alarm is triggered.

To change these settings:

1. Press MENU key to go to the Main Menu screen.
2. Press UP or DOWN keys and ENTER key to enter TECHNICIAN password 1313.
3. Press UP or DOWN keys to scroll to **Adv System Config**; press ENTER key.
4. Press UP or DOWN keys to scroll to **Dirty Cond Alarm (B3)**; press ENTER key.
5. Press ENTER key to scroll to **Alarm Threshold** (see Figure 40).
6. Press UP or DOWN keys to adjust the % restriction to desired level.
7. Press ENTER key to save value and move the cursor to **Trips before alarm**.
8. Press UP or DOWN keys to change the **Trips before alarm** to the desired value.
9. Press ENTER key to save.
10. Press ESCAPE key several times to return to Main Menu screen.

**FIGURE 40**  
**Adjusting Dirty Condenser Coil Alarm Settings**

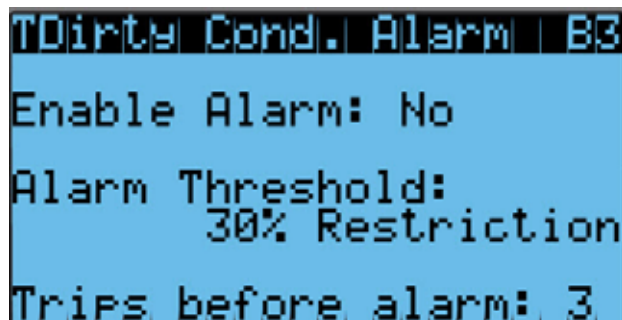

## Compressor

### Compressor Components

#### Compressor

##### *Three Phase Scroll Compressor Start Up Information*

Scroll compressors, like several other types of compressors, will only compress in one rotational direction. Direction of rotation is not an issue with single phase compressors since they will always start and run in the proper direction.

However, three phase compressors will rotate in either direction depending upon phasing of the power. Since there is a 50-50 chance of connecting power in such a way as to cause rotation in the reverse direction, verification of proper rotation must be made. Verification of proper rotation direction is made by observing that suction pressure drops and discharge

pressure rises when the compressor is energized. Reverse rotation also results in an elevated sound level over that with correct rotation, as well as substantially reduced current draw compared to tabulated values.

Verification of **proper rotation** must be made at the time the equipment is put into service. If improper rotation is corrected at this time, there will be no negative impact on the durability of the compressor. However, reverse operation for over 1 hour may have a negative impact on the bearing due to oil pump out.

**NOTE:** *If compressor is allowed to run in reverse rotation for an extended period of time, the compressor's internal protector will trip.*

All three phase compressors are wired identically internally. As a result, once the correct phasing is determined for a specific system or installation, connecting properly phased power leads to the same Fusite terminal should maintain proper rotation direction.

The direction of rotation of the compressor may be changed by reversing any two line connections to the wall-mount unit.

#### **Compressor Control Module (CCM)**

Delay-on-Make Timer

Short Cycle Protection/Delay-on-Break

Test Mode

High Pressure Detection

Brownout Protection with Adjustment

The LPC terminals are jumpered in this application. Instead, the low pressure transducer is used for low pressure monitoring.

#### **Delay-on-Make Timer**

In the event of power loss, a delay-on-make timer is included to be able to delay startup of the compressor. This is desired when more than one unit is on a structure so that all of the units do not start at the same time which could happen after a power loss or building shutdown. The delay-on-make time period is 2 minutes plus 10% of the delay-on-break time period. To ensure that all of the units do not start at the same time, adjust the delay-on-break timer on each unit to a slightly different delay time.

#### **Short Cycle Protection/Delay-on-Break**

An anti-short cycle timer is included to prevent short cycling the compressor. This is adjustable from 30 seconds to 5 minutes via the adjustment knob (see Figure 41 on page 26). Once a compressor call is lost, the time period must expire before a new call will be initiated.

10% of this time is also considered on the delay-on-make timer (see above).

#### **High Pressure Detection**

High pressure switch monitoring allows for a lockout condition in a situation where the switch is open. If the high pressure switch opens, the CCM will de-energize

**FIGURE 41**  
**8201-164 Compressor Control Module**

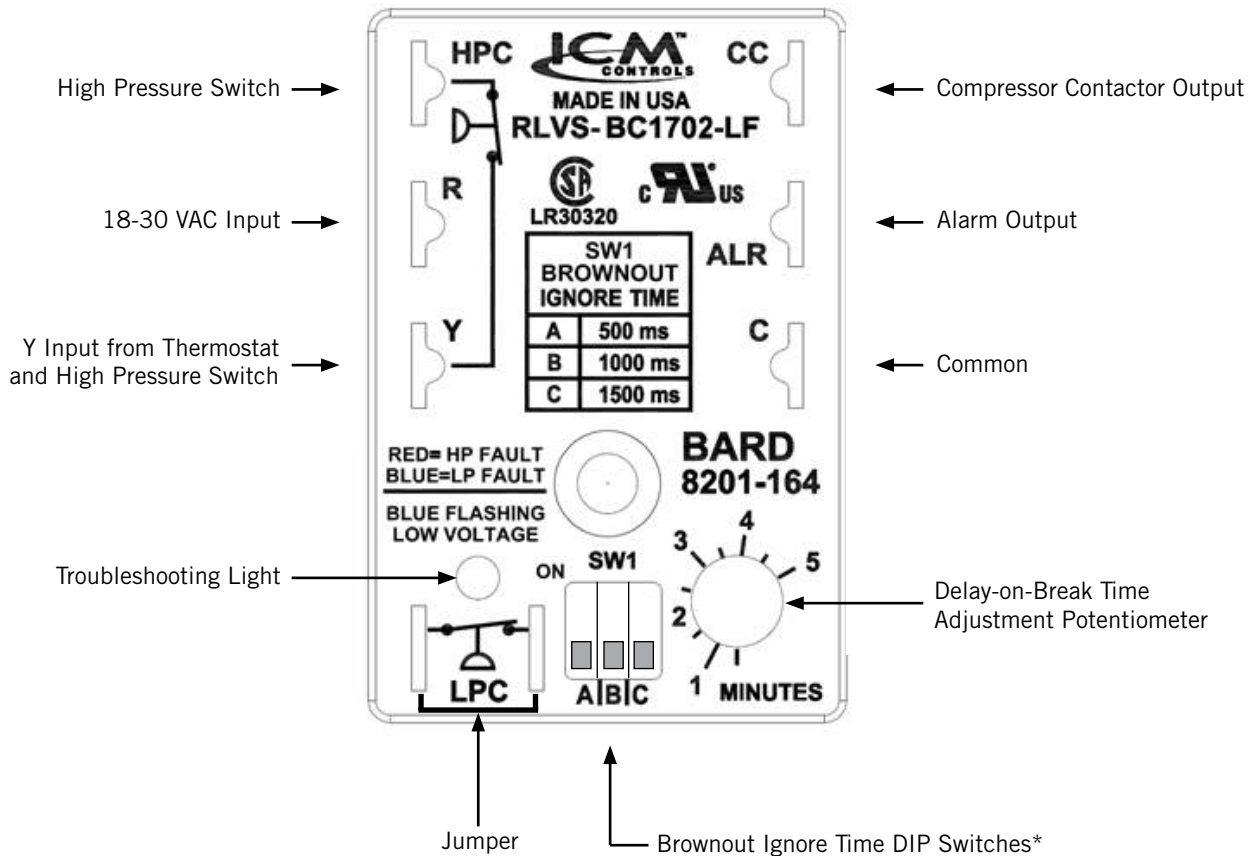

\* Turn on only one switch for that specific ignore time setting

the compressor. If the switch closes, it will then restart the compressor after the delay-on-break setting has expired on the device. If the switch trips again during the same Y call, the compressor will be de-energized. The ALR terminal will be energized, signaling the unit control board that a high pressure event has occurred (see **Refrigerant High Pressure Alarm** on page 27).

**Test Mode**

By rapidly rotating the potentiometer (POT) clockwise (see Figure 41), all timing functions will be removed for testing.

The conditions needed for the unit to enter test mode are as follows: POT must start at a time less than or equal to the 40 second mark. The POT must then be rapidly rotated to a position greater than or equal to the 280 second mark in less than ¼ second. Normal operation will resume after power is reset or after the unit has been in test mode for at least 5 minutes.

**Brownout Protection with Adjustment**

Brownout protection may be necessary if the utility power or generator power has inadequate power to prevent the voltage from dropping when the compressor

starts. This is rare but can happen if the generator is undersized at the site or if the site is in a remote location far from the main power grid. Under normal circumstances, allowing the brownout to be ignored for a time period should not be needed. The 8201-164 is shipped with all the DIP switches in the 'off' or 'do not ignore' position (see Figure 41).

If ignoring the brownout is needed because of the above conditions, three preset timers can be set by DIP switches in order to delay signaling a power brownout for a specific length of time after compressor contactor is energized. This allows the compressor a time period to start even if the voltage has dropped and allows the voltage to recover. This delay only happens when the CC terminal energizes. The delay can be set to 500 milliseconds (A DIP switch), 1000 milliseconds (B DIP switch) or 1500 milliseconds (C DIP switch); time is not cumulative—only the longest setting will apply. If the voltage recovers during the brownout time period, the compressor will start.

If a brownout condition is detected by the 8201-164, the troubleshooting light will flash blue. The light will continue to flash until the cooling call is satisfied or

power is removed from the Y terminal. This condition does not prevent operation, it only indicates that a brownout condition was present at some point during the cooling call. If a brownout condition is detected, CC will be de-energized and will retry after the delay-on-make timer is satisfied; this process will continue until call is satisfied.

If user chooses the 'do not ignore' position when the site has inadequate utility or generator power, this could lead to the compressor never starting. The control will see the brownout immediately and not start.

A common scenario and one that has been seen in the field is when a unit or units switches from utility power to generator power. With slower transfer switches, the time delay between the utility power and generator power didn't cause a problem. The units lost power, shut off and came back on line normally. With the introduction of almost instantaneous transfer switches, the millisecond long power glitch can be enough that the compressor will start to run backwards. In this scenario, the CCM will catch this and restart the units normally.

### High Pressure Safety Switch

All units have a high pressure switch as a safety device. This device will open when pressure in the system reaches 650 PSIG. The sensor is directly connected to the dedicated compressor control module (see **High Pressure Detection** on page 25).

### Refrigerant High Pressure Alarm

When the wall-mount unit receives a signal from the compressor control module (CCM) indicating a high pressure event, the wall-mount unit will generate an alarm. Upon receiving the alarm, the wall-mount unit will remove the "Y" call from the CCM, resetting the status of the CCM. The alarm will stay present on the wall-mount unit until manually cleared with TEC-EYE hand-held diagnostic tool.

In addition to the CCM, the discharge pressure transducer is used to prevent a high pressure event. When the discharge pressure is above the discharge pressure alarm setpoint (set 30 PSI below high pressure switch, which is 650 PSI), the system will disable stage 2 of mechanical cooling.

### Phase Monitor

Used only on three phase equipment, the phase monitor is a compressor protection device that will prohibit operation of the compressor if the device senses a possible reverse-rotation situation due to incorrect phasing. On a call for compressor (and only compressor), the device will check incoming phase, check for severe voltage imbalance and check for proper frequency. Under nominal conditions, a green LED light will show on the face of the monitor. If there is improper phasing, voltage imbalance or frequency deviation, the device will show a red LED light and prohibit compressor operation.

If a fault condition occurs, reverse two of the supply leads to the unit. **Do not reverse any of the unit factory wires as damage may occur.**

## Compressor Operation

The compressor will be enabled when the unit (in stand alone mode) or LV provide a cooling stage 1 call. The compressor call from the controller has several delays that may affect the start or stop time of the compressor in regards to the cooling demand. The compressor has a minimum on time of 120 seconds to prevent short cycling the compressor. The compressor also has a minimum off time of 120 seconds to prevent start ups before the pressure in the refrigeration system equalizes. When the second stage is engaged, it also has a minimum run time of 120 seconds to allow the system to stabilize before returning to single stage or shutting down.

These delays can be changed by:

1. Press MENU key to go to the Main Menu screen.
2. Press UP or DOWN keys and ENTER key to enter TECHNICIAN password 1313.
3. Press UP or DOWN keys to scroll to **Adv System Config**; press ENTER key.
4. Press UP or DOWN keys to scroll to **Unit Config (B2)**; press ENTER key.
5. Press ENTER key to scroll to **Min On, Min Off, Min On Same, Unloader Del or Address Delay** (see Figure 42).
6. Press UP or DOWN keys to change the value.
7. Press ENTER key to save value and move the cursor to next parameter or top of screen.
8. Press ESCAPE key several times to return to Main Menu screen.

**FIGURE 42**  
**Adjusting Compressor Delays**

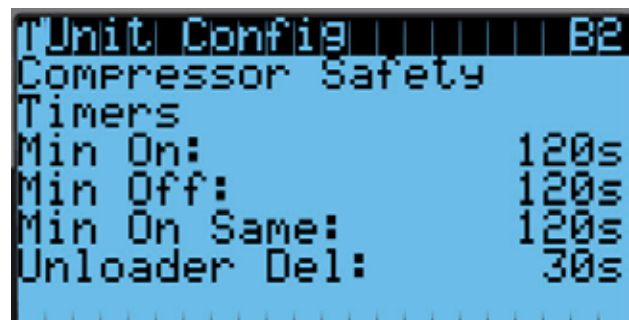

The address-based delay only applies to the wall-mount unit when in stand alone mode. The controller will delay the unit compressor based on the value entered on screen B2 multiplied by the unit address. This is intended to keep multiple units from starting their

compressors at the same time when there is a quick change in the load. When connected to the LV, this is taken care of by LV logic.

### Additional Compressor Alarms

#### **Refrigerant Low Pressure Alarm**

When the suction pressure transducer indicates a pressure value less than the low pressure alarm setpoint of 40 PSIG and there is an active call for cooling, the controller will disable the compressor (after a 180-second delay). **NOTE: The second call will be delayed based on the delay off value mentioned in the compressor section.** The controller will try to run the refrigeration system two (2) times within 900 seconds before the alarm will lock the compressor out. This alarm needs to be manually cleared before compressor operation will resume.

To adjust the low pressure alarm settings:

1. Press MENU key to go to the Main Menu screen.
2. Press UP or DOWN keys and ENTER key to enter USER password 2000.
3. Press UP or DOWN keys to scroll to **System Config**; press ENTER key.
4. Press UP or DOWN keys to scroll to **Alarm Setup (A6)**; press ENTER key.
5. Press ENTER key to scroll to **Delay** to adjust how long the compressor waits before turning the compressor off (see Figure 43).
6. Press UP or DOWN keys to adjust the time delay.
7. Press ENTER key to scroll to **Two Count Del.**
8. Press UP or DOWN keys to adjust the delay value.
9. Press ENTER key to save.
10. Press the ESCAPE key several times to return to Main Menu screen.

**FIGURE 43**  
Adjusting Low Pressure Alarm Settings

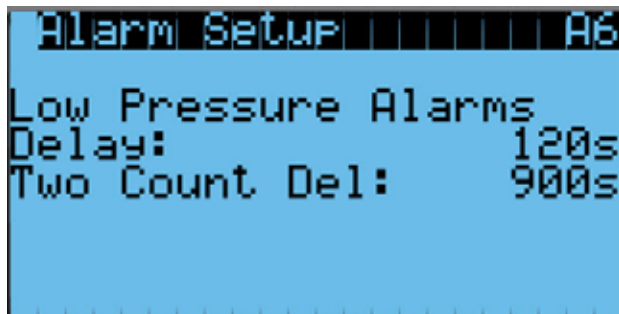

## **Economizer**

### Economizer Components

#### **Actuator**

The actuator rotates up to 90° based on a 0-10v signal sent to it by the controller. The actuator is rated at 44 lb-in and is spring return when power is lost. This component is what opens and closes the damper blade.

To verify the output from the controller to the actuator:

1. Press MENU key to go to the Main Menu screen.
2. Press UP or DOWN keys and ENTER key to enter TECHNICIAN password 1313.
3. Press UP or DOWN keys to scroll to **I/O Config**; press ENTER key.
4. Press UP or DOWN keys to scroll to **Damper Override (C14)**; press ENTER key.
5. Reference the **Damper Position** for the current output to the damper (see Figure 44).
6. To override the current position, press ENTER key to scroll to **Damper OV Pos.**
7. Press UP or DOWN keys to change the value to the desired output.
8. Press ENTER key to save the value and move cursor to **Override.**
9. Press UP or DOWN keys to change the value from **Disabled** to **Enabled.**
10. The **Damper Position** will update with the new override value and the damper will travel to that position.

**NOTE: This override will last for 5 minutes or until the Override is changed back to Disabled.**

**FIGURE 44**  
Damper Override

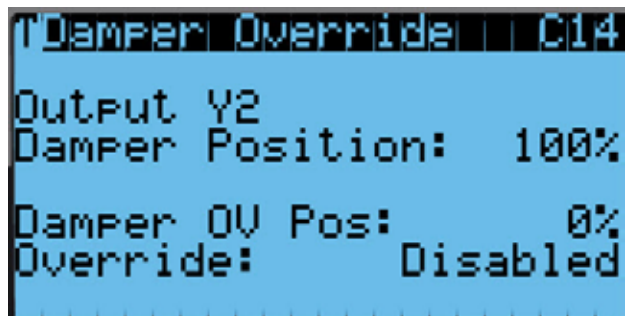

#### **Dust Sensor**

The unit has a dust sensor installed near the outdoor air inlet. The dust sensor checks for excessive particulates in the outdoor air, and will close the economizer if the dust is excessive. The sensor uses a PWM signal converted to 0-5v output to the controller.

To ensure proper performance, cleaning may be required. Vacuuming or blowing the dust off the sensor with forced air is recommended. **Avoid inserting any objects into the sensor.**

The dust sensor can be verified by:

1. Press MENU key to go to the Main Menu screen.
  2. Press UP or DOWN keys and ENTER key to enter TECHNICIAN password 1313.
  3. Press UP or DOWN keys to scroll to **I/O Config**; press ENTER key.
  4. Press UP or DOWN keys to scroll to **Dust Sensor (C8)**; press ENTER key.
  5. Reference the **Value** for the current sensor reading (see Figure 45).
  6. To apply an offset to the current reading, press ENTER key to scroll to **Offset**.
  7. Press UP or DOWN keys to adjust the value to the desired value.
  8. Press ENTER key to save the value and move cursor to next parameter.
- NOTE:** The sensor can be disabled if required for troubleshooting.
9. With the cursor on the **Enable** parameter, press UP or DOWN keys to change the value from **ON** to **OFF**.
  10. Press ENTER key to save.

**FIGURE 45**  
Dust Sensor



#### **Dust Sensor Failure Alarm**

When the sensor reads a value that is outside of the acceptable 0 to 100% range, an alarm will be generated indicating the sensor has failed. This alarm is just a notification and will not disable any other features on the controller.

This alarm is fixed and cannot be adjusted.

#### **High Dust Limit Alarm**

When dust content in the air is high and is a risk to prematurely reducing airflow through the filters, the unit will restrict the use of the economizer. The

controller has adjustable software setpoints (default to 80%) to indicate dust levels are too high and to disable the economizer operation for 5 minutes (unit default). This alarm is not communicated to the NOC. Once the conditions are no longer present, the alarm will automatically clear.

Disabling the dust sensor in **I/O Config** disables this alarm.

To adjust the dust sensor alarm setpoint:

1. Press MENU key to go to the Main Menu screen.
2. Press UP or DOWN keys and ENTER key to enter USER password 2000.
3. Press UP or DOWN keys to scroll to **System Config**; press ENTER key.
4. Press UP or DOWN keys to scroll to **Alarm Setup (A9)**; press ENTER key.
5. Press ENTER key to scroll to **Setpoint** (see Figure 46).
6. Press UP or DOWN keys to change to the desired value.
7. Press ENTER key to save the value.

**NOTE:** When the temperature outside is measured at or below 0°F, the dust sensor alarm will be disabled to allow economizer operation. This is done because the compressor is disabled below 0°F and the system would not have the capability to cool.

**FIGURE 46**  
Adjusting Dust Sensor Alarm Setpoint



#### **Damper Blade**

The system utilizes three damper blades used to bring in outdoor air and exhaust space air for economizer operation. The damper blades are made of sheet metal and are integrated into the equipment.

#### **Damper Switch**

The economizer utilizes a magnetic switch to determine if the damper is operating correctly. This switch will be closed when the damper is closed and open when the damper is open.

To verify the status of the switch:

1. Press MENU key to go to the Main Menu screen.
2. Press UP or DOWN keys and ENTER key to enter TECHNICIAN password 1313.
3. Press UP or DOWN keys to scroll to **I/O Config**; press ENTER key.
4. Press UP or DOWN keys to scroll to **Digital In Config (C2)**; press ENTER key.
5. Reference the value located at **6 Damp** row and **Val** column (see Figure 47).
6. The input will display **ON** when the damper is closed (reflecting closed circuit on damper switch) and will display **OFF** when the damper is open (reflecting open circuit on damper switch).

**FIGURE 47**  
**Damper Switch**

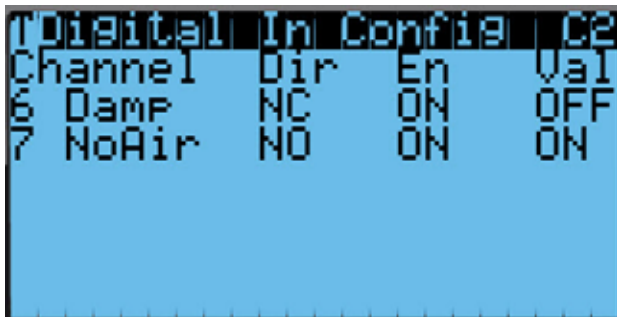

Channel	Dir	En	Val
6 Damp	NC	ON	OFF
7 NoAir	NO	ON	ON

#### **Damper Failed to Open Alarm**

When the controller commands the economizer damper actuator to a position other than 0% and the damper switch indicates the damper is not open, after a delay of 20 seconds the controller will generate a damper failed to open alarm. This alarm is just a notification and will not disable any features on the controller.

Disabling the damper switch in **I/O Config** disables this alarm.

To adjust the damper failed to open delay:

1. Press MENU key to go to the Main Menu screen.
2. Press UP or DOWN keys and ENTER key to enter USER password 2000.
3. Press UP or DOWN keys to scroll to **System Config**; press ENTER key.
4. Press UP or DOWN keys to scroll to **Alarm Setup (A4)**; press ENTER key.
5. Press ENTER key to scroll to **Open Delay** (see Figure 48).
6. Press UP or DOWN keys to change to the desired value.
7. Press ENTER key to save the value.

**FIGURE 48**  
**Adjusting Damper Alarm Delay**

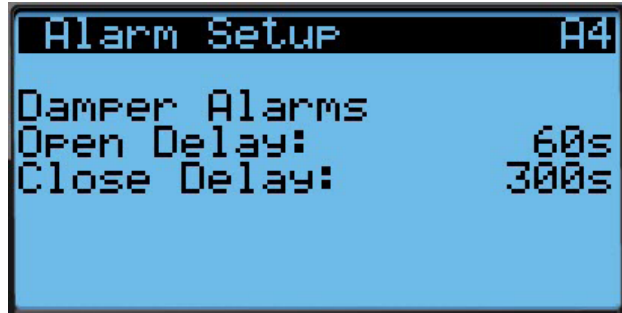

#### **Damper Failed to Close Alarm**

When the controller commands the economizer damper actuator to the 0% position and the damper switch indicates the damper is not closed, after a delay of 300 seconds the controller will generate a damper failed to close alarm. This alarm is just a notification and will not disable any features on the controller.

Disabling the damper switch in **I/O Config** disables this alarm.

To adjust the damper failed to close delay:

1. Press MENU key to go to the Main Menu screen.
2. Press UP or DOWN keys and ENTER key to enter USER password 2000.
3. Press UP or DOWN keys to scroll to **System Config**; press ENTER key.
4. Press UP or DOWN keys to scroll to **Alarm Setup (A4)**; press ENTER key.
5. Press ENTER key to scroll to **Close Delay** (see Figure 48).
6. Press UP or DOWN keys to change to the desired value.
7. Press ENTER key to save the value.

#### **Outdoor Temperature and Humidity Combination Sensor**

The unit is equipped with a combination outdoor temperature and humidity sensor to monitor outdoor conditions for the economizer operation. The temperature is measured with a 10k ohm NTC thermistor. The humidity is measured with a humidity sensor that outputs a 4-20mA signal to the controller.

The outdoor temperature can be verified by:

1. Press MENU key to go to the Main Menu screen.
2. Press UP or DOWN keys and ENTER key to enter TECHNICIAN password 1313.
3. Press UP or DOWN keys to scroll to **I/O Config**; press ENTER key.
4. Press UP or DOWN keys to scroll to **Outdoor Air Sensor (C4)**; press ENTER key.

5. Reference the **Value** to see the input of the sensor (see Figure 49).
6. To apply an offset, press ENTER key to scroll to **Offset**.
7. Press UP or DOWN keys to change to the desired value.
8. Press ENTER key to save the value.

**FIGURE 49**  
**Outdoor Air Sensor**



The outdoor humidity can be verified by:

1. Press MENU key to go to the Main Menu screen.
2. Press UP or DOWN keys and ENTER key to enter TECHNICIAN password 1313.
3. Press UP or DOWN keys to scroll to **I/O Config**; press ENTER key.
4. Press UP or DOWN keys to scroll to **Outdoor Hum Sensor (C7)**; press ENTER key.
5. Reference the **Value** to see the input of the sensor (see Figure 50).
6. To apply an offset, press ENTER key to scroll to **Offset**.
7. Press UP or DOWN keys to change to the desired value.
8. Press ENTER key to save the value.

**FIGURE 50**  
**Outdoor Humidity Sensor**



#### **Outdoor Temperature Sensor Failure Alarm**

When the sensor reads a value that is outside of the acceptable -41 to 303.0° range, an alarm will be generated indicating the sensor has failed. This alarm condition will disable the economizer.

This alarm is fixed and cannot be adjusted.

#### **Outdoor Humidity Sensor Failure Alarm**

When the sensor reads a value that is outside of the acceptable 0 to 100% RH range, an alarm will be generated indicating the sensor has failed. This alarm condition will disable the economizer when the mode is set to temperature and humidity or enthalpy.

This alarm is fixed and cannot be adjusted.

#### **Supply Temperature Sensor**

The unit is equipped with a supply air temperature sensor to monitor the leaving air temperature of the unit. The temperature is measured with a 10k ohm NTC thermistor.

The supply air temperature can be verified by:

1. Press MENU key to go to the Main Menu screen.
2. Press UP or DOWN keys and ENTER key to enter TECHNICIAN password 1313.
3. Press UP or DOWN keys to scroll to **I/O Config**; press ENTER key.
4. Press UP or DOWN keys to scroll to **Supply Air Sensor (C6)**; press ENTER key.
5. Reference the **Value** to see the input of the sensor (see Figure 51).
6. To apply an offset, press ENTER key to scroll to **Offset**.
7. Press UP or DOWN keys to change to the desired value.
8. Press ENTER key to save the value.

**FIGURE 51**  
**Supply Air Sensor**



### Supply Temperature Sensor Failure Alarm

When the sensor reads a value that is outside of the acceptable -41.0 to 303.0° range, an alarm will be generated indicating the sensor has failed.

This alarm is fixed and cannot be adjusted.

### High Supply Air Temperature Alarm

When the supply air temperature measurement for the economizer to be enabled is above the outdoor air temperature setpoint (70°F) for 120 seconds, an alarm will be generated and the economizer will be disabled until the cooling call has been removed. This alarm will automatically reset once the economizer is no longer disabled.

To change the high supply air temperature alarm:

1. Press MENU key to go to the Main Menu screen.
2. Press UP or DOWN keys and ENTER key to enter USER password 2000.
3. Press UP or DOWN keys to scroll to **System Config**; press ENTER key.
4. Press UP or DOWN keys to scroll to **Alarm Setup (A5)**; press ENTER key.
5. Press ENTER key to scroll to **Hi and Diff** value (see Figure 52).
6. Press UP or DOWN keys to change the differential to the desired value.
7. Press ENTER key to save and scroll to the next parameter.

FIGURE 52

#### Adjusting Supply Air Temperature Differential

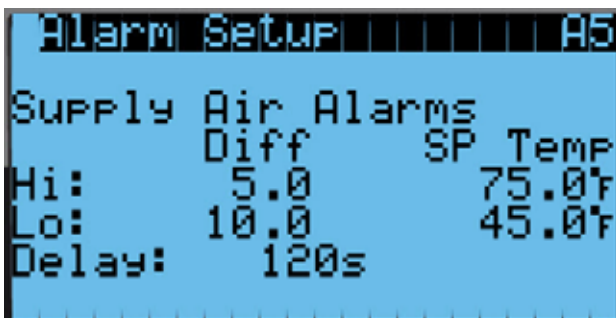

### Low Supply Air Temperature Alarm

When the supply air temperature is below 45°F for 120 seconds, an alarm will be generated and the economizer will be disabled until the cooling call has been removed. This alarm will automatically reset when the economizer is no longer disabled.

To change the low supply air temperature alarm:

1. Press MENU key to go to the Main Menu screen.
2. Press UP or DOWN keys and ENTER key to enter USER password 2000.

3. Press UP or DOWN keys to scroll to **System Config**; press ENTER key.
  4. Press UP or DOWN keys to scroll to **Alarm Setup (A5)**; press ENTER key.
  5. Press ENTER key to scroll to **Lo and Diff** value (see Figure 52).
  6. Press UP or DOWN keys to change the differential to the desired value.
  7. Press ENTER key to save value and scroll to **Delay**.
  8. Press UP or DOWN keys to adjust the delay value.
- NOTE:** This delay is also applied to the high supply air temperature alarm.
9. Press ENTER key to save.

### Economizer Operation

The economizer has four types of operation. The first mode is "None" where the economizer is never utilized, except for emergency purposes. The second mode is "Dry Bulb" where the outdoor temperature is the only consideration for economizer use on a freecooling call. The third mode is "TempHum" where the outdoor temperature and humidity are considered for economizer use on a freecooling call. The fourth mode is "Enthalpy" where the outdoor temperature, humidity and calculated dew point are considered for economizer operation on a freecooling call.

To change the economizer type:

1. Press MENU key to go to the Main Menu screen.
2. Press UP or DOWN keys and ENTER key to enter USER password 2000.
3. Press UP or DOWN keys to scroll to **System Config**; press ENTER key.
4. Press UP or DOWN keys to scroll to **Economizer Setup (A2)**; press ENTER key.
5. Press ENTER key to scroll to **Type** (see Figure 53).

FIGURE 53

#### Economizer Setup

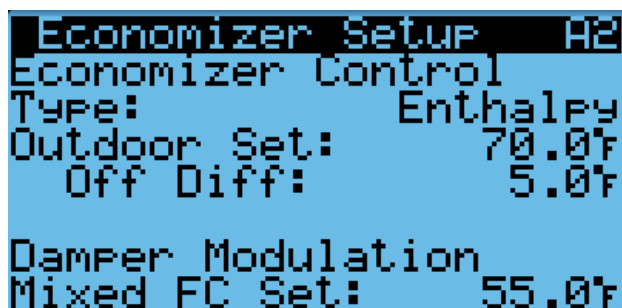



6. Press UP or DOWN keys to change the **Type** desired value to **None**, **Dry Bulb**, **TempHum** or **Enthalpy**.
7. Press ENTER key to save the value and scroll to the next parameter.

**NOTE:** The following parameters are for the temperature consideration for economizer use. Applies to **Dry Bulb**, **TempHum** and **Enthalpy** type.

8. The cursor should now be on the **Outdoor Set** parameter.
9. Press UP or DOWN keys to change the parameter to the desired value.
10. Press ENTER key to save the value and scroll to the next parameter.
11. The cursor should now be on **Off Diff** parameter.
12. Press UP or DOWN keys to change the parameter to the desired value.
13. Press ENTER key to save the value and move to the next parameter.
14. The cursor is now on the **Mixed FC Set** parameter.
15. Press UP or DOWN keys to change the parameter to the desired value.
16. Press ENTER key to save the value.
17. Press the DOWN key to navigate to the **A3** screen.

**NOTE:** This screen will not display if economizer mode is set to **Dry Bulb** or **None**. Also, the contents of the screen will change when type is set to **Enthalpy** (see Figure 54) as compared to when type is set to **TempHum** (see Figure 58 on page 34). The following menu shows the **Enthalpy** content which also contains parameters that would be shown on **TempHum**.

18. Press ENTER key to scroll to **OA Humid Set** (see Figure 55).
19. Press UP or DOWN keys to change the humidity setpoint to desired value.
20. If set to **TempHum**, continue on to Step 22. If set to **Enthalpy**, press ENTER key to save the value and scroll to **OA Dew Pt Set**.
21. Press UP or DOWN keys to adjust the outdoor dew point setpoint for economizer operation to the desired value.
22. Press ENTER key to save the value and scroll to **On Diff**.
23. Press UP or DOWN keys to adjust the outdoor humidity differential for which the economizer is re-enabled.
24. Press ENTER key to save the value and scroll to parameter **Delay**.

**FIGURE 54**  
**Economizer Setup – Enthalpy Control**

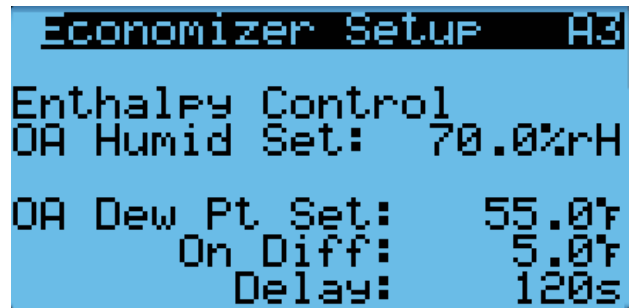

**FIGURE 55**  
**Economizer Setup – TempHum Control**

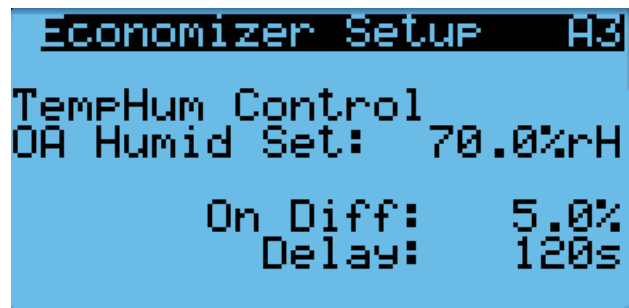

25. Press UP or DOWN keys to adjust the time the actual measurements can be outside of the disabling parameters before the economizer operation is disabled.
26. Press ENTER key to save the value.
27. Press ESCAPE key several times to return to Main Menu screen.

See Table 8 on page 34 for default settings for economizer operation.

When the economizer is activated during a freecooling call only, using any of the previously mentioned modes, a 0-10v analog signal will be sent to the economizer actuator. Regardless of economizer only, or optimized cooling mode, the actuator will then open and close the damper blades to maintain a supply air temperature of 55°F. During optimized cooling mode, the damper blades will be limited to a max output of 60%. When the supply/mixed air temperature increases, the damper will open and when the mixed air temperature decreases, the damper will close.

The economizer may be disabled by the LV if the system determines it needs to enter dehumidification mode. More information about the dehumidification sequence can be found on page 15 and in the latest revision of LV1000 Service Instructions 2100-673. In addition to dehum mode, the economizer may be disabled for 5 minutes (adjustable) if the dust sensor indicates the outdoor air may cause particulate buildup in the

**TABLE 8  
Economizer Default Settings**

Mode			Consideration	Economizer Available for Cooling	Economizer Not Available for Cooling
Temp Only	Temp & Humidity	Enthalpy*	Temperature	When the outdoor air temperature is below 70°F	When the outdoor air temperature is above 75°F
			Humidity	<b>LV Online:</b> When the outdoor humidity is below 80%	<b>LV Online:</b> When the outdoor humidity is above 80%
				<b>LV Offline:</b> When the outdoor humidity is below 60%	<b>LV Offline:</b> When the outdoor humidity is above 60%
		Dew Point	When the outdoor dew point is below 55°F	When the outdoor dew point is above 60°F	

\* In Enthalpy mode, outdoor temperature, humidity and calculated dew point are all considered for economizer operation.

air filters. After the time has expired and on a call for cooling, the economizer will open again to sample the air. The wall-mount unit will either return to normal operation or remain locked out for another 5 minutes.

### Emergency Cooling Mode

If the shelter temperature is above the high temperature alarm setpoint on the LV, the unit will be commanded into emergency cooling mode. In this mode, the unit will operate the economizer regardless of the economizer setup, as long as the outdoor temperature is below the indoor temperature. The cooling demand will be automatically set to 100% in this mode, meaning mechanical cooling should be operating at full capacity while this mode is active. This will stay active until the LV returns the unit to normal operation. This mode is only available when connected to the LV.

### Emergency Ventilation Mode

If a hydrogen detector is connected to the LV/FUSION-TEC system and there is a hydrogen alarm event, the system will go into emergency ventilation mode. In emergency ventilation mode, the economizers on the wall units will be commanded to 100%. After 2 minutes, the blowers will turn on in order to exhaust any hydrogen gas buildup within the shelter. Once the hydrogen alarm clears, the system will resume normal operation. This mode is only available when connected to the LV.

### Model/Serial Number Configuration

FUSION-TEC wall-mount units configure some settings based on the model number that is input into the unit. The model and serial numbers are entered at the factory and should be retained during a software update. However, after a software update, it is best practice to verify that the model and serial numbers are still present and accurate. If the model and/or serial number is missing or incorrect, they will need to be re-entered.

**NOTE:** When re-entering the model number, only valid model number entries will be accepted by the PLC.

To update model/serial numbers:

1. Press MENU key to go to the Main Menu screen.
2. Press UP or DOWN keys and ENTER key to enter ENGINEER password 9254.
3. Press UP or DOWN keys to scroll to **Adv Sys Config**; press ENTER key.
4. Press UP or DOWN keys to scroll to **Factory Settings (B1)**.
5. Press ENTER key to advance the cursor to the digit that needs changed in the model/serial number.
6. Press UP or DOWN keys to change value of the digit.
7. Continue Steps 5 and 6 until the model/serial number(s) are correct and reflect the number on the product label.

For more information on the options and settings available for specific model numbers, please see the model number breakdown in Figure 57 on page 38.

### Electric Heat Option

#### Electric Heat Components

##### Electric Heating Element

The unit is optionally equipped with a 1.5kw or 5kw heat strip. The heat strip is located next to the blower assembly and uses resistive heat.

##### Thermal Overload

The heater assembly has a thermal overload wired in series with the heating element. This device has a cycling limit which opens at 130°F and resets at 80°F. The limit is also equipped with a redundant thermal fuse that will open at 150°F.

#### Electric Heat Operation

The heat strip will be activated on a call for heat. This call can be generated by the LV or the wall-mount unit operating in stand alone mode.

## **Bard Guard Anti-Theft System Option**

The unit has the option to be shipped from the factory with a low pressure switch, panel sensors and a speaker. These devices are used with the Bard Guard BG1000 anti-theft controller to provide an anti-theft measure. These sensors and switch form a loop that when connected to the BG1000 controller will cause the system to go into alarm if any of the front panels or coil assemblies are removed without being disarmed. The speaker provides an audible alert that the system is being tampered with. The Bard Guard anti-theft control sensor connection is wired to terminals 7 and 8 on the wall-mount unit. The speaker connection is wired to terminals 5 and 6 on the wall-mount unit. See the latest revision of BG1000 Installation Instructions 2100-672 for directions on connecting the wall-mount units to the BG1000 controller.

## **Smoke Detector Unit Disable Option**

The unit is equipped with an input that can be used with a smoke detector or unit disable switch with a dry contact. When this input indicates a smoke event, the system will be shut down. The alarm will automatically clear when the alarm condition is no longer present.

## **Inverter Option**

The inverter is only used in applications where a generator is not present and the wall-mount units must run during a power loss event. The inverter will always keep power available to the wall-mount units during a power outage. In the event of a power outage, a power loss relay in the FUSION-TEC HR Series wall-mount unit will be energized and will only allow the blower and economizer to run while powering the controller. The inverter converts either 24 VDC or 48 VDC, depending on the model, to 230 VAC. A relay output from the inverter will also communicate an alarm to the supervisory controller in the event of an inverter failure. This variable can be communicated through the Ethernet port for integration into a building management system. The units will continue to run in economizer-only operation until power has been restored or the battery power has been depleted.

When the FUSION-TEC HR Series wall-mount unit is operating under inverter power, shelter economizer cooling will only occur if outside temperatures fall below indoor temperatures and blower speeds are slightly reduced to conserve battery power.

**FIGURE 56**  
**FUSION-TEC HR Series Wall-Mount Unit Control Board 8301-068-002\***

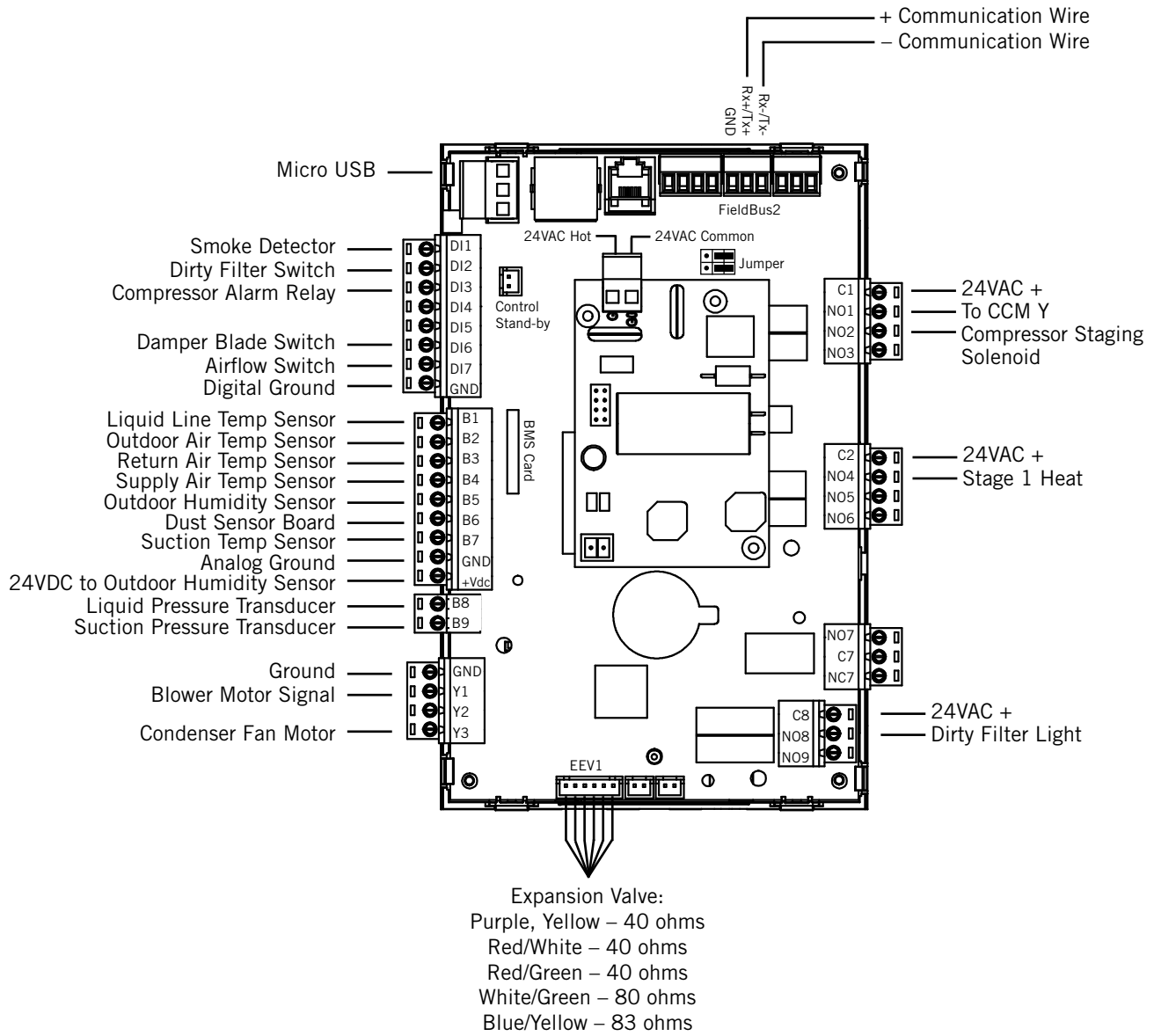

\* Asterisk represents letter at end of part number that designates software version (Example: 8301-068-002**A**).

**TABLE 9**  
**FUSION-TEC HR Series Wall-Mount Unit Control Board Terminals**

<b>Terminal</b>	<b>Function</b>	<b>Type</b>	<b>Form</b>
Rx+/Tx+		Communication	
Rx-/Tx-		Communication	
DI1	Smoke Detector	Digital	N/C
DI2	Dirty Filter Switch	Digital	N/C
DI3	Compressor Alarm Relay	Digital	N/C
DI4	Not Used		
DI5	Not Used		
DI6	Damper Blade Switch	Digital	N/C
DI7	Airflow	Digital	N/C
GND	Digital Ground		
B1	Liquid Line Temperature Sensor	Analog Output	10K Ohm Curve J
B2	Outdoor Air Temperature Sensor	Analog Output	10K Ohm Type III (AN)
B3	Return Air Temperature Sensor	Analog Output	10K Ohm Curve J
B4	Supply Air Temperature Sensor	Analog Output	10K NTC Thermistor
B5	Outdoor Humidity Sensor	Analog Output	
B6	Dust Sensor Board	Analog Output	0-5VDC
B7	Suction Temperature Sensor	Analog Output	10K Ohm Curve J
GND	Analog Ground		
+VDC	24VDC to Outdoor Humidity Sensor		
B8	Liquid Pressure Transducer	Analog Output	.5VDC to 4.5VDC
B9	Suction Pressure Transducer	Analog Output	.5VDC to 4.5VDC
Y1	Blower Motor Signal		
Y2	Not Used		
Y3	Condenser Motor Signal		
GND	Ground		
C1	24VAC+	Power	
NO1	to CCM "Y"	Relay Output	
NO2	Compressor Staging Solenoid	Relay Output	
NO3	Not Used		
C2	24VAC+	Power	
NO4	Stage 1 Heating	Relay Output	
NO5	Not Used		
NO6	Not Used		
NO7	Not Used		
C7	Not Used		
NC7	Not Used		
C8	24VAC+	Power	
NO8	Dirty Filter Light	Relay Output	
GO	24VAC Common		
G	24VAC Hot		

**FIGURE 57**  
**FUSION-TEC HR Series Wall-Mount Unit Model Nomenclature**

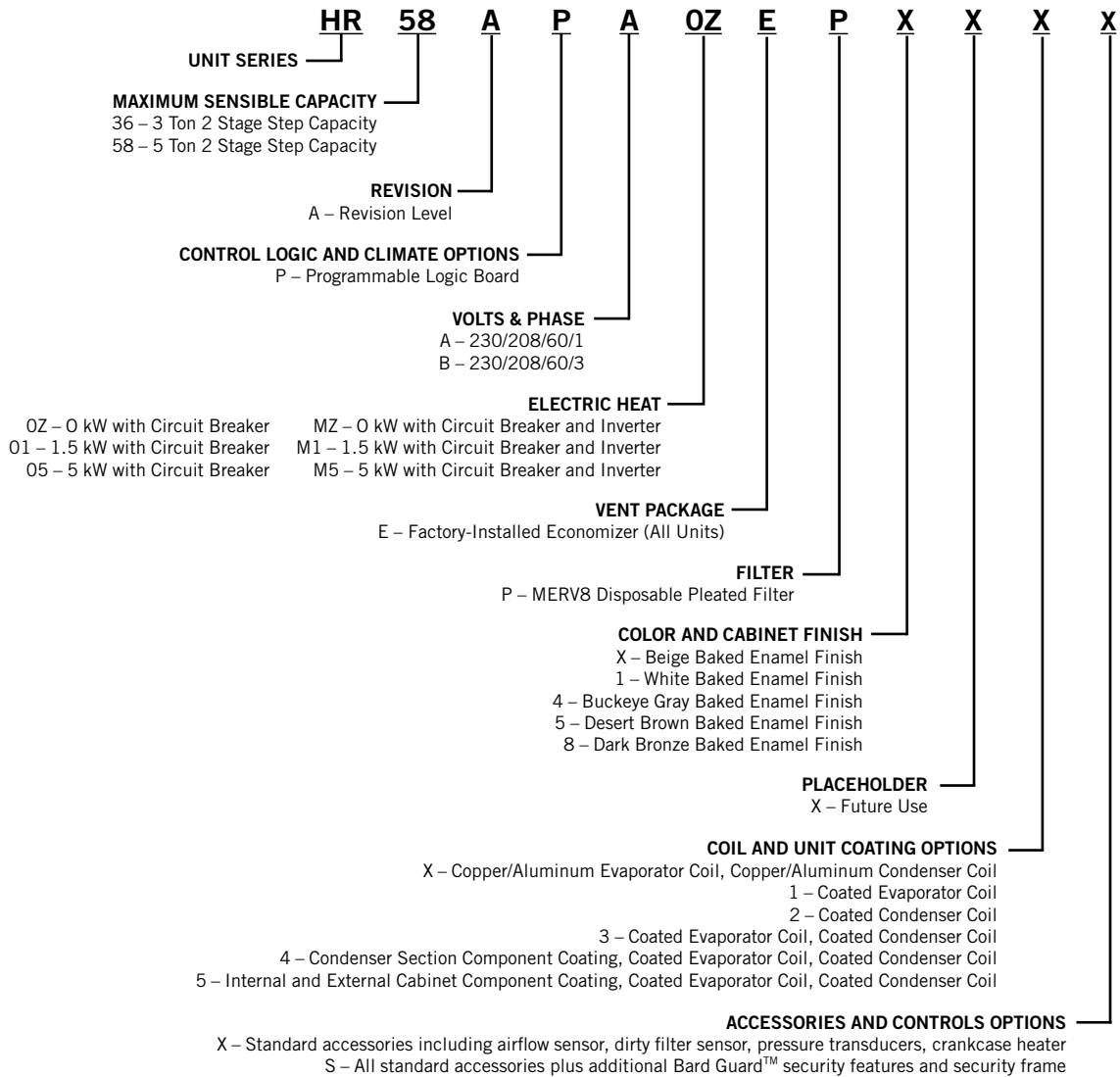

# REFRIGERANT INFORMATION

## NOTICE

These units require R-410A refrigerant and polyol ester oil.

### General

1. Use separate service equipment to avoid cross contamination of oil and refrigerants.
2. Use recovery equipment rated for R-410A refrigerant.
3. Use manifold gauges rated for R-410A (800 PSI/250 PSI low).
4. R-410A is a binary blend of HFC-32 and HFC-125.
5. R-410A is nearly azeotropic—similar to R-22 and R-12. Although nearly azeotropic, charge with liquid refrigerant.
6. R-410A operates at 40-70% higher pressure than R-22, and systems designed for R-22 cannot withstand this higher pressure.
7. R-410A has an ozone depletion potential of zero, but must be reclaimed due to its global warming potential.
8. R-410A compressors use polyol ester oil.
9. Polyol ester oil is hygroscopic; it will rapidly absorb moisture and strongly hold this moisture in the oil.
10. A liquid line dryer must be used—even a deep vacuum will not separate moisture from the oil.
11. Limit atmospheric exposure to 15 minutes.
12. If compressor removal is necessary, always plug compressor immediately after removal. Purge with small amount of nitrogen when inserting plugs.

### Topping Off System Charge

If a leak has occurred in the system, Bard Manufacturing recommends reclaiming, evacuating (see criteria above) and charging to the nameplate charge. If done correctly, topping off the system charge can be done without problems.

With R-410A, there are no significant changes in the refrigerant composition during multiple leaks and recharges. R-410A refrigerant is close to being an azeotropic blend (it behaves like a pure compound or single component refrigerant). The remaining refrigerant charge in the system may be used after leaks have occurred. “Top-off” the charge by utilizing the pressure charts on the inner control panel cover as a guideline.

**REMEMBER:** When adding R-410A refrigerant, it must come out of the charging cylinder/tank as a liquid to avoid any fractionation and to insure optimal system performance. Refer to instructions for the cylinder that is being utilized for proper method of liquid extraction.

### Safety Practices

1. Never mix R-410A with other refrigerants.
2. Use gloves and safety glasses. Polyol ester oils can be irritating to the skin, and liquid refrigerant will freeze the skin.
3. Never use air and R-410A to leak check; the mixture may become flammable.
4. Do not inhale R-410A—the vapor attacks the nervous system, creating dizziness, loss of coordination and slurred speech. Cardiac irregularities, unconsciousness and ultimately death can result from breathing this concentration.
5. Do not burn R-410A. This decomposition produces hazardous vapors. Evacuate the area if exposed.
6. Use only cylinders rated DOT4BA/4BW 400.
7. Never fill cylinders over 80% of total capacity.
8. Store cylinders in a cool area, out of direct sunlight.
9. Never heat cylinders above 125°F.
10. Never trap liquid R-410A in manifold sets, gauge lines or cylinders. R-410A expands significantly at warmer temperatures. Once a cylinder or line is full of liquid, any further rise in temperature will cause it to burst.

### Important Installer Note

For improved start-up performance, wash the indoor coil with a dishwashing detergent.

### R410-A Refrigerant Charge

This wall-mount unit was charged at the factory with the quantity of refrigerant listed on the serial plate. AHRI capacity and efficiency ratings were determined by testing with this refrigerant charge quantity.

Table 10 on page 40 shows nominal pressures for the units. Since many installation specific situations can affect the pressure readings, this information should only be used by certified technicians as a guide for evaluating proper system performance. They shall not be used to adjust charge. If charge is in doubt, reclaim, evacuate and recharge the wall-mount unit to the serial plate charge.

## Pressure Service Ports

High and low pressure service ports are installed on all wall-mount units so that the system operating pressures can be observed. Pressures are shown in Table 10.

This unit employs high-flow Coremax valves instead of the typical Schrader type valves.

**WARNING! Do NOT use a Schrader valve core removal tool with these valves. Use of such a tool could result in eye injuries or refrigerant burns!**

To change a Coremax valve without first removing the refrigerant, a special tool is required which can be obtained at [www.fastestinc.com/en/SCCA07H](http://www.fastestinc.com/en/SCCA07H). See the replacement parts manual for replacement core part numbers.

**TABLE 10**  
**Cooling Pressures**

Full Load Cooling			Air Temperature Entering Outdoor Coil °F										
Model	Return Air Temp (DB/WB)	Pressure	75	80	85	90	95	100	105	110	115	120	125
HR36	75/62	Low Side	130	131	132	134	135	136	137	138	139	140	142
		High Side	290	312	334	359	384	411	439	468	498	530	564
	80/67	Low Side	139	140	141	143	144	145	147	148	149	150	152
		High Side	297	320	343	368	394	422	450	480	511	544	578
	85/72	Low Side	144	145	146	148	149	150	152	153	154	155	157
		High Side	307	331	355	381	408	437	466	497	529	563	598
HR58	75/62	Low Side	129	130	131	132	133	134	136	137	137	139	140
		High Side	318	340	365	389	414	440	467	495	527	553	584
	80/67	Low Side	138	139	140	141	142	143	145	146	147	149	150
		High Side	326	349	374	399	425	451	479	508	537	567	599
	85/72	Low Side	143	144	145	146	147	148	150	151	152	154	155
		High Side	337	361	387	413	440	467	496	526	556	587	620

Part Load Cooling			Air Temperature Entering Outdoor Coil °F										
Model	Return Air Temp (DB/WB)	Pressure	75	80	85	90	95	100	105	110	115	120	125
HR36	75/62	Low Side	119	125	131	136	140	143	146	148	149	150	149
		High Side	268	288	308	331	354	378	405	432	460	490	522
	80/67	Low Side	127	134	140	145	150	153	156	158	159	160	159
		High Side	275	295	316	339	363	388	415	443	472	503	535
	85/72	Low Side	131	139	145	150	155	158	161	164	165	166	165
		High Side	285	305	327	351	376	402	430	459	489	521	554
HR58	75/62	Low Side	135	136	136	137	137	138	138	140	141	142	143
		High Side	283	304	327	350	375	402	428	456	486	416	547
	80/67	Low Side	144	145	145	146	147	148	148	150	151	152	153
		High Side	290	312	335	359	385	412	439	468	498	529	561
	85/72	Low Side	149	150	150	151	152	153	154	155	156	157	158
		High Side	300	323	347	372	398	426	454	484	515	548	581

Low side pressure ± 4 PSIG  
High side pressure ± 10 PSIG

Tables are based upon rated CFM (airflow) across the evaporator coil. If there is any doubt as to correct operating charge being in the system, the charge should be removed and system evacuated and recharged to serial plate charge weight.

**NOTE:** Pressure table based on high speed condenser fan operation. If condensing pressures appear elevated check condenser fan wiring. See "Condenser Fan Operation" on page 24.



## Standard Maintenance Procedures

### **WARNING**

**Electrical shock hazard.**

**Disconnect all power supplies before servicing.**

**Failure to do so could result in electric shock or death.**

### **CAUTION**

**Cut hazard.**

**Wear gloves to avoid contact with sharp edges.**

**Failure to do so could result in personal injury.**

1. Disable system from LV1000 controller (see latest revision of LV1000 Service Instructions 2100-673).
2. Turn off AC breakers at wall-mount units.
3. Check inlet sides of condenser and evaporator coils for obstructions/debris—clean if necessary using a quality manufactured coil cleaning product specific for the evaporator or condenser coil.
  - Condenser coil: Remove the upper side panels from the condenser section. This will give clear access to the inlet side of the coil for cleaning. Follow the coil cleaner manufacturer's directions for necessary safety gear and precautions, as well as for application and use. More than one application may be necessary. Rinse thoroughly.
  - Evaporator coil: Open filter access panels and remove filters. Apply specific evaporator cleaner directly to the inlet side of coil, being very careful not to overspray into insulation or surrounding panels and wiring. Residual cleaner and dissolved debris should drip into the drain pan and leave the unit through the condensate hose. More than one application may be necessary. Rinse thoroughly.
4. Manually spin fan and blower motors to ensure they turn freely. All motors are permanently lubricated, so no oil is necessary.
5. Inspect free cooling damper actuator and linkage.
6. Install new air filter; check for additional filter grilles internal to the structure.
7. Inspect the control panel of the system.
  - Look for insect or rodent activity and remove any nesting materials.
  - Manually push contactor closed, observe for movement—contactor points should have minimal discoloration, no spalling or other signs of arcing. Replace if doubtful.
  - Check field and factory wiring for tightness and look for signs of overheating (discoloration of terminals or wire insulation).
8. Ensure that supply and return registers are not obstructed, and more importantly, are not recycling the air to one another. Adjust supply louvers if necessary to direct discharge air away from any direct route to the return grille.
9. Re-assemble wall-mount unit, turn breakers back on.
10. Enable system to LV1000 controller (see latest revision of LV1000 Service Instructions 2100-673).
11. Repeat steps for additional wall-mount units.

### **Bard Guard Anti-Theft System Option**

While the system is powered, push DISARM/RESET button to disarm the system. Once the button is pushed, the blue LED will illuminate. As long as the blue LED is illuminated, the Bard Guard system is disarmed and will remain disarmed depending on the preset time for up to 250 minutes (default approximate 15 minutes). After the preset time expires, the system will rearm automatically.

For situations that require an individual unit to be disconnected from the Bard Guard security system for an extended period of service time (longer than the maximum 250 minutes disarm time), place a jumper across the appropriate terminals on the BG1000 terminal block to temporarily remove the unit from the security system. **Be sure to remove the jumper from the terminals after service has been completed.**

See the latest revision of BG1000 Installation Instructions 2100-672 for information on operating the BG1000 controller.

# TROUBLESHOOTING

---

## 8301-067 Outdoor Temperature/Humidity Sensor

FIGURE 58  
8301-067 Sensor DIP Switches and Terminal Block

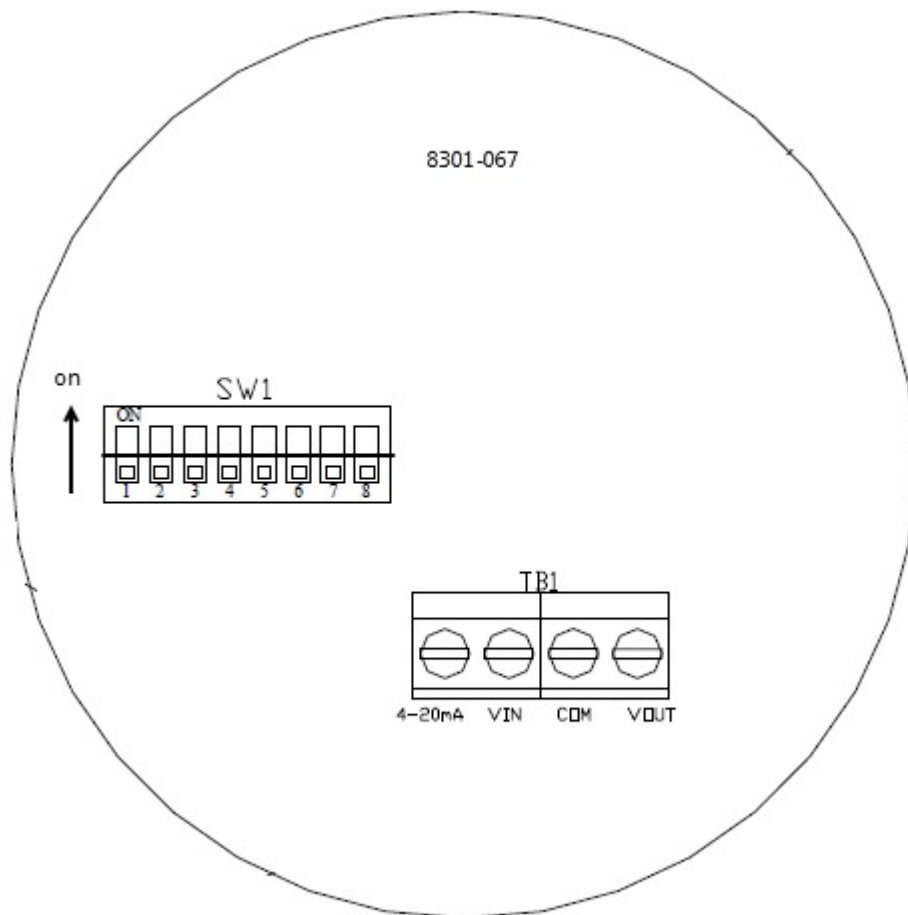

**TABLE 11**  
**8301-067 Sensor: Temperature/Resistance**

Temperature		Resistance	Temperature		Resistance	Temperature		Resistance	Temperature		Resistance
F	C	Ω	F	C	Ω	F	C	Ω	F	C	Ω
-25	-31.7	148,452.94	13	-10.6	48,892.46	51	10.6	18,337.51	89	31.7	7679.76
-24	-31.1	143,910.37	14	-10.0	47,571.97	52	11.1	17,898.38	90	32.2	7515.86
-23	-30.6	139,521.46	15	-9.4	46,291.29	53	11.7	17,471.09	91	32.8	7355.94
-22	-30.0	135,280.55	16	-8.9	45,049.09	54	12.2	17,055.30	92	33.3	7199.88
-21	-29.4	131,182.22	17	-8.3	43,844.12	55	12.8	16,650.65	93	33.9	7047.59
-20	-28.9	127,221.25	18	-7.8	42,675.14	56	13.3	16,256.82	94	34.4	6898.95
-19	-28.3	123,392.63	19	-7.2	41,540.99	57	13.9	15,873.48	95	35.0	6753.88
-18	-27.8	119,691.54	20	-6.7	40,440.51	58	14.4	15,500.34	96	35.6	6612.28
-17	-27.2	116,113.37	21	-6.1	39,372.62	59	15.0	15,137.09	97	36.1	6474.05
-16	-26.7	112,653.66	22	-5.6	38,336.26	60	15.6	14,783.44	98	36.7	6339.11
-15	-26.1	109,308.15	23	-5.0	37,330.40	61	16.1	14,439.11	99	37.2	6207.37
-14	-25.6	106,072.72	24	-4.4	36,354.06	62	16.7	14,103.83	100	37.8	6078.74
-13	-25.0	102,943.44	25	-3.9	35,406.29	63	17.2	13,777.34	101	38.3	5953.15
-12	-24.4	99,916.50	26	-3.3	34,486.17	64	17.8	13,459.38	102	38.9	5830.51
-11	-23.9	96,988.26	27	-2.8	33,592.81	65	18.3	13,149.70	103	39.4	5710.75
-10	-23.3	94,155.21	28	-2.2	32,725.36	66	18.9	12,848.07	104	40.0	5593.78
-9	-22.8	91,413.97	29	-1.7	31,883.00	67	19.4	12,554.26	105	40.6	5479.55
-8	-22.2	88,761.30	30	-1.1	31,064.92	68	20.0	12,268.04	106	41.1	5367.98
-7	-21.7	86,194.07	31	-0.6	30,270.36	69	20.6	11,989.19	107	41.7	5258.99
-6	-21.1	83,709.29	32	0.0	29,498.58	70	21.1	11,717.51	108	42.2	5152.53
-5	-20.6	81,304.06	33	0.6	28,748.85	71	21.7	11,452.79	109	42.8	5048.52
-4	-20.0	78,975.60	34	1.1	28,020.48	72	22.2	11,194.83	110	43.3	4946.91
-3	-19.4	76,721.24	35	1.7	27,312.81	73	22.8	10,943.45	111	43.9	4847.63
-2	-18.9	74,538.41	36	2.2	26,625.18	74	23.3	10,698.45	112	44.4	4750.62
-1	-18.3	72,424.61	37	2.8	25,956.98	75	23.9	10,459.65	113	45.0	4655.83
0	-17.8	70,377.48	38	3.3	25,307.60	76	24.4	10,226.90	114	45.6	4563.20
1	-17.2	68,394.70	39	3.9	24,676.45	77	25.0	10,000.00	115	46.1	4472.67
2	-16.7	66,474.07	40	4.4	24,062.97	78	25.6	9778.81	116	46.7	4384.19
3	-16.1	64,613.46	41	5.0	23,466.62	79	26.1	9563.15	117	47.2	4297.71
4	-15.6	62,810.82	42	5.6	22,886.87	80	26.7	9352.89	118	47.8	4213.18
5	-15.0	61,064.17	43	6.1	22,323.22	81	27.2	9147.86	119	48.3	4130.55
6	-14.4	59,371.62	44	6.7	21,775.16	82	27.8	8947.93	120	48.9	4049.77
7	-13.9	57,731.32	45	7.2	21,242.23	83	28.3	8752.95	121	49.4	3970.79
8	-13.3	56,141.52	46	7.8	20,723.96	84	28.9	8562.79	122	50.0	3893.58
9	-12.8	54,600.50	47	8.3	20,219.91	85	29.4	8377.31	123	50.6	3818.08
10	-12.2	53,106.64	48	8.9	19,729.65	86	30.0	8196.39	124	51.1	3744.26
11	-11.7	51,658.35	49	9.4	19,252.76	87	30.6	8019.91	125	51.7	3672.07
12	-11.1	50,254.11	50	10.0	18,788.84	88	31.1	7847.74			

**TABLE 12**  
**8301-067 Sensor: Humidity/mA**

<b>RH%</b>	<b>mA Output</b>	<b>RH%</b>	<b>mA Output</b>	<b>RH%</b>	<b>mA Output</b>
0	4.000 mA	34	9.440 mA	68	14.880 mA
1	4.160 mA	35	9.600 mA	69	15.040 mA
2	4.320 mA	36	9.760 mA	70	15.200 mA
3	4.480 mA	37	9.920 mA	71	15.360 mA
4	4.640 mA	38	10.080 mA	72	15.520 mA
5	4.800 mA	39	10.240 mA	73	15.680 mA
6	4.960 mA	40	10.400 mA	74	15.840 mA
7	5.120 mA	41	10.560 mA	75	16.000 mA
8	5.280 mA	42	10.720 mA	76	16.160 mA
9	5.440 mA	43	10.880 mA	77	16.320 mA
10	5.600 mA	44	11.040 mA	78	16.480 mA
11	5.760 mA	45	11.200 mA	79	16.640 mA
12	5.920 mA	46	11.360 mA	80	16.800 mA
13	6.080 mA	47	11.520 mA	81	16.960 mA
14	6.240 mA	48	11.680 mA	82	17.120 mA
15	6.400 mA	49	11.840 mA	83	17.280 mA
16	6.560 mA	50	12.000 mA	84	17.440 mA
17	6.720 mA	51	12.160 mA	85	17.600 mA
18	6.880 mA	52	12.320 mA	86	17.760 mA
19	7.040 mA	53	12.480 mA	87	17.920 mA
20	7.200 mA	54	12.640 mA	88	18.080 mA
21	7.360 mA	55	12.800 mA	89	18.240 mA
22	7.520 mA	56	12.960 mA	90	18.400 mA
23	7.680 mA	57	13.120 mA	91	18.560 mA
24	7.840 mA	58	13.280 mA	92	18.720 mA
25	8.000 mA	59	13.440 mA	93	18.880 mA
26	8.160 mA	60	13.600 mA	94	19.040 mA
27	8.320 mA	61	13.760 mA	95	19.200 mA
28	8.480 mA	62	13.920 mA	96	19.360 mA
29	8.640 mA	63	14.080 mA	97	19.520 mA
30	8.800 mA	64	14.240 mA	98	19.680 mA
31	8.960 mA	65	14.400 mA	99	19.840 mA
32	9.120 mA	66	14.560 mA	100	20.000 mA
33	9.280 mA	67	14.720 mA		

## 8408-044 Return Air Sensor/Suction Sensor

**TABLE 13**  
**8408-044 Sensor: Temperature/Resistance Curve J**

Temperature °F	Resistance Ω	Temperature °F	Resistance Ω	Temperature °F	Resistance Ω	Temperature °F	Resistance Ω
-25.0	196871	13.0	56985	53.0	19374	89.0	7507
-24.0	190099	14.0	55284	52.0	18867	90.0	7334
-23.0	183585	15.0	53640	53.0	18375	91.0	7165
-22.0	177318	16.0	52051	54.0	17989	92.0	7000
-21.0	171289	17.0	50514	55.0	17434	93.0	6840
-20.0	165487	18.0	49028	56.0	16984	94.0	6683
-19.0	159904	19.0	47590	57.0	16547	95.0	6531
-18.0	154529	20.0	46200	58.0	16122	96.0	6383
-17.0	149355	21.0	44855	59.0	15710	97.0	6239
-16.0	144374	22.0	43554	60.0	15310	98.0	6098
-15.0	139576	23.0	42295	61.0	14921	99.0	5961
-14.0	134956	24.0	41077	62.0	14544	100.0	5827
-13.0	130506	25.0	39898	63.0	14177	101.0	5697
-12.0	126219	26.0	38757	64.0	13820	102.0	5570
-11.0	122089	27.0	37652	65.0	13474	103.0	5446
-10.0	118108	28.0	36583	66.0	13137	104.0	5326
-9.0	114272	29.0	35548	67.0	12810	105.0	5208
-8.0	110575	30.0	34545	68.0	12492	106.0	5094
-7.0	107010	31.0	33574	69.0	12183	107.0	4982
-6.0	103574	32.0	32634	70.0	11883	108.0	4873
-5.0	100260	33.0	31723	71.0	11591	109.0	4767
-4.0	97064	34.0	30840	72.0	11307	110.0	4663
-3.0	93981	35.0	29986	73.0	11031	111.0	4562
-2.0	91008	36.0	29157	74.0	10762	112.0	4464
-1.0	88139	37.0	28355	75.0	10501	113.0	4367
0.0	85371	38.0	27577	76.0	10247	114.0	4274
1.0	82699	39.0	26823	77.0	10000	115.0	4182
2.0	80121	40.0	26092	78.0	9760	116.0	4093
3.0	77632	41.0	25383	79.0	9526	117.0	4006
4.0	75230	42.0	24696	80.0	9299	118.0	3921
5.0	72910	43.0	24030	81.0	9077	119.0	3838
6.0	70670	44.0	23384	82.0	8862	120.0	3757
7.0	68507	45.0	22758	83.0	8653	121.0	3678
8.0	66418	46.0	22150	84.0	8449	122.0	3601
9.0	64399	47.0	21561	85.0	8250	123.0	3526
10.0	62449	48.0	20989	86.0	8057	124.0	3452
11.0	60565	49.0	20435	87.0	7869		
12.0	58745	50.0	19896	88.0	7686		

## 8301-066 Supply Air Sensor

**TABLE 14**  
**8301-066 Sensor: Temperature/Resistance**

Temperature	Resistance	Temperature	Resistance	Temperature	Resistance
°C	Ω	°C	Ω	°C	Ω
0	29,490	36	6501	72	1868
1	28,157	37	6260	73	1810
2	26,891	38	6028	74	1754
3	25,689	39	5806	75	1700
4	24,547	40	5594	76	1648
5	23,462	41	5390	77	1598
6	22,431	42	5195	78	1550
7	21,450	43	5007	79	1503
8	20,518	44	4828	80	1458
9	19,631	45	4656	81	1414
10	18,787	46	4490	82	1372
11	17,983	47	4332	83	1332
12	17,219	48	4180	84	1293
13	16,490	49	4034	85	1255
14	15,797	50	3893	86	1218
15	15,136	51	3759	87	1183
16	14,506	52	3629	88	1149
17	13,906	53	3505	89	1116
18	13,334	54	3386	90	1084
19	12,788	55	3271	91	1053
20	12,268	56	3160	92	1023
21	11,771	57	3054	93	994
22	11,297	58	2952	94	967
23	10,845	59	2854	95	940
24	10,413	60	2760	96	913
25	10,000	61	2669	97	888
26	9606	62	2582	98	864
27	9229	63	2498	99	840
28	8869	64	2417	100	817
29	8525	65	2339	101	795
30	8196	66	2264	102	774
31	7882	67	2191	103	753
32	7581	68	2122	104	733
33	7293	69	2055	105	713
34	7018	70	1990	106	694
35	6754	71	1928	107	676

## 8301-057 Blower Status Switch/Dirty Filter Switch

FIGURE 59  
8301-057 Air Differential Switch Terminals

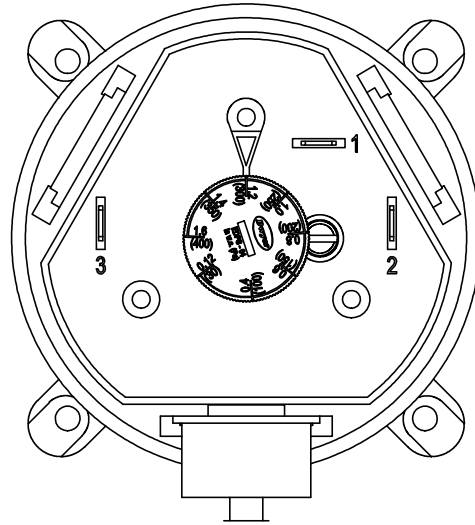

### Terminals

- 1 – Normally Open
- 2 – Normally Closed
- 3 – Common