SERVICE INSTRUCTIONS

MEGA-TEC® WALL-MOUNT AIR CONDITIONER

Models: W090A & W120A



NOTE: LC6000 controller is required for operation when W090A or W120A units are used.



Climate Control Solutions

Bard Manufacturing Company, Inc.
Bryan, Ohio 43506
www.bardhvac.com

Manual: 2100-671B
Supersedes: 2100-671A
Date: 9-20-19

CONTENTS

General Information4

Multi-Stage Cooling System	4
Wall-Mount Air Conditioner Units	4
General	4
Shipping Damage	4
Additional Publications	4

Using the TEC-EYE™6

TEC-EYE Hand-Held Diagnostic Tool.....	6
TEC-EYE Menu Structure.....	7
TEC-EYE Acronyms	7
Main Status Screen.....	7
Quick Menu	8
Setpoints	8
Information	8
A/C Circuit Information.....	8
Program Version.....	9
Software Versioning Guide	9
Alarm Log	10
Menu Screens and Password Levels.....	10
Executing a Self Test.....	10
Self Test Parameter Descriptions	10
Reset to Factory Defaults.....	10

Operation11

Unit On/Off	11
Alarm Adjustment	11
Acknowledging Alarms.....	11
Clearing Alarms	11
Clearing Alarm Logs and Counters	11
Exporting Alarm Logs	11
Exporting 7 Day Logs	12
Exporting Parameters	12
Zone.....	12
Temperature Control.....	12
Temperature Control Components	12
Return Air Temperature Sensor.....	12
Return Air Temperature Alarm	12
Temperature Control Operation.....	12
Orphan Mode	13
LC6000 Control.....	13
Cooling (with Economizer)	13
Cooling (without Economizer).....	13
Heating.....	13
Electronic Expansion Valve (EEV)	14
EEV Components	14
Electronic Expansion Valve	14
EEV Instructions for Vacuum, Reclaim, Charge Unit	14
System Pressures.....	15
Suction Pressure Transducer	15
Troubleshooting the Suction Pressure Transducer	15
Suction Pressure Alarm	16
Suction Temperature Sensor	16
Suction Temperature Alarm.....	16
Evaporator Freeze Condition Alarm	16
EEV Operation	17
EEV Superheat Control	17
Additional EEV Alarms	17
Low Superheat Alarm	17
Indoor Airflow.....	17
Indoor Airflow Components	17
Blower	17

Blower Status Switch	18
Blower Status Alarm.....	18
Filters.....	18
Dirty Filter Switch.....	18
Dirty Filter Alarm	19
Filter Indicator Light	19
Indoor Airflow Operation	19
Blower Speed Control	19
Additional Indoor Airflow Alarms	19
Supply Air Temperature Alarm.....	19
Condenser Fan	20
Condenser Fan Components.....	20
Condenser Fan	20
Liquid Pressure Sensor.....	20
Troubleshooting the Discharge/ Liquid Pressure Transducer	21
Discharge/Liquid Pressure Transducer Alarm.....	21
Liquid Temperature Sensor	21
Outdoor Temperature Sensor	21
Condenser Fan Operation.....	21
Condenser Fan Speed Control	21
Compressor	22
Compressor Components	22
Compressor	22
Compressor Control Module (CCM)	22
Delay-on-Make Timer.....	22
Short Cycle Protection/Delay-on-Break ..	22
High Pressure Detection	22
Test Mode	22
Brownout Protection w/Adjustment.....	22
High Pressure Safety Switch	23
Refrigerant High Pressure Alarm.....	23
Phase Monitor	24
Compressor Operation	24
Additional Compressor Alarms.....	24
Refrigerant Low Pressure Alarm.....	24
Economizer	24
Economizer Components	24
Actuator.....	24
Dust Sensor	25
Dust Sensor Failure Alarm	25
High Dust Limit Alarm.....	25
Damper Blade	26
Damper Switch	26
Damper Failed to Open Alarm	26
Damper Failed to Close Alarm	26
Outdoor Temperature and Humidity	
Combination Sensor	27
Outdoor Temperature Sensor Failure Alarm.....	27
Outdoor Humidity Sensor Failure Alarm.....	27
Mixed Air Temperature Sensor.....	27
High Mixed Air Temperature Alarm	28
Low Mixed Air Temperature Alarm	28
Economizer Operation	28
Economizer Operation – Minimum Position ..	30
Miscellaneous Components.....	30
Supply Temperature Sensor	30
Supply Temperature Sensor Failure Alarm	30
Emergency Cooling Mode.....	30

Emergency Cooling – Orphan Mode	30	Figure 27	Enabling Fan Override	20
Emergency Ventilation Mode	31	Figure 28	Adjusting Discharge/Liquid Transducer Pressure Values	20
Electric Heat Option	31	Figure 29	Voltage to Pressure: Discharge/Liquid Pressure Transducer	21
Electric Heat Components	31	Figure 30	Adjusting Discharge/Liquid Temperature Input	21
Electric Heating Element	31	Figure 31	8201-164 Compressor Control Module	23
Thermal Overload	31	Figure 32	Adjusting Compressor Delays	24
Electric Heat Operation	31	Figure 33	Damper Override	25
Electric Reheat Dehumidification	31	Figure 34	Dust Sensor	25
Electric Reheat Dehumidification Operation	32	Figure 35	Adjusting Dust Sensor Alarm Setpoint	26
Unit Disable Option	33	Figure 36	Damper Blade Position	26
Serial/Model Number Configuration	33	Figure 37	Damper Switch	26
Refrigerant Information	35	Figure 38	Outdoor Temperature Sensor	27
General	35	Figure 39	Outdoor Humidity Sensor	27
Topping Off System Charge	35	Figure 40	Mixed Air Temperature Sensor	28
Safety Practices	35	Figure 41	Economizer Setup	28
Important Installer Note	35	Figure 42	Economizer Setup – Dry Bulb Control	29
R410-A Refrigerant Charge	35	Figure 43	Economizer Setup – TempHum Control	29
Pressure Service Ports	36	Figure 44	Economizer Setup – Enthalpy Control	29
Maintenance	38	Figure 45	Supply Air Temperature Sensor	30
Standard Maintenance Procedures	38	Figure 46	Emergency Cool – Orphan Mode	31
Troubleshooting	39	Figure 47	Adjusting Return Air Alarm Settings	31
8301-089 Outdoor Temperature/Humidity Sensor	41	Figure 48	Electric Reheat Dehumidification	32
8620-296 Supply Air Sensor/Return Air Sensor/ Mixed Air Sensor/Suction Sensor/Liquid Sensor	44	Figure 49	Dehumidification Control (°F)	32
8301-057 Blower Status Switch/Dirty Filter Switch	45	Figure 50	Unit Disable Option	33
Alarm Index	46	Figure 51	Serial/Model Number Configuration	33
Modbus Troubleshooting for MEGA-TEC	49	Figure 52	MEGA-TEC Model Nomenclature	34
Blower Speeds	52	Figure 53	Sensors and Peripheral Devices	39
I/O Layout	54	Figure 54	Supply and Return Air Sensors	40
FIGURES AND TABLES		Figure 55	8301-089 Sensor DIP Switches and Terminal Block	41
Figure 1	TEC-EYE Display and Interface	Figure 56	8301-057 Air Differential Switch	45
Figure 2	TEC-EYE Connection to Unit Control	Figure 57	Disconnect Condenser Fan Communication Wires	49
Figure 3	Quick Menu Icons	Figure 58	Unplug Modbus from Expansion Module	49
Figure 4	Cool and Heat Setpoints	Figure 59	Verify Modbus is Connected to PLC Board	49
Figure 5	MEGA-TEC Refrigeration Circuits	Figure 60	Verify Blower Is Online	49
Figure 6	A/C Circuit Measurements	Figure 61	Reverse Polarity of Wires from Blower Motor	49
Figure 7	Program Version	Figure 62	Check Address	50
Figure 8	Executing Self Test	Figure 63	Ventilation Airflow Paths	53
Figure 9	Restoring Factory Default Settings	Table 1	Unit Status Messages	7
Figure 10	Clearing All Alarms	Table 2	Software Versioning Guide	9
Figure 11	Clearing Alarm Logs and Counters	Table 3	LC6000/TEC-EYE Passwords (Defaults)	10
Figure 12	Changing Zone	Table 4	Unit Specific Superheat Setpoints	17
Figure 13	Adjusting Return Air Temperature Sensor	Table 5	Rated Airflow	17
Figure 14	Cooling (with Economizer)	Table 6	Indoor Blower Performance	18
Figure 15	Cooling (without Economizer)	Table 7	Maximum ESP of Operation: Electric Heat Only	18
Figure 16	Heating	Table 8	Condenser Fan Nominal Speed	21
Figure 17	Overriding EEV Output	Table 9	Economizer Default Settings	29
Figure 18	Electronic Expansion Valve (EEV) and Service Tool	Table 10	Cooling Capacity Limitation	32
Figure 19	Adjusting Suction Sensor/Transducer Pressure Values	Table 11	W090A* Cooling Pressures	36
Figure 20	Voltage to Pressure: Suction Pressure Transducer	Table 12	W0120A* Cooling Pressures	37
Figure 21	Adjusting Suction Temperature Sensor Values	Table 13	8301-089 Sensor: Temperature/ Resistance	42
Figure 22	Adjusting Evaporator Freeze Sensor Values	Table 14	8301-089 Sensor: Humidity/mA	43
Figure 23	Putting Blower Output into Override Mode	Table 15	8620-296 Sensor: Temperature/ Resistance Curve J	44
Figure 24	Dirty Filter Switch and Blower Status Switch	Table 16	Blower Speeds	52
Figure 25	Verifying Differential Airflow Status			
Figure 26	Dirty Filter Switch and Filter Indicator Light			

GENERAL INFORMATION

Multi-Stage Cooling System

This Bard cooling system is composed of MEGA-TEC Series wall-mounted air conditioners matched with an LC6000 lead/lag controller. The wall mounts are specifically engineered for telecom/motor control center rooms.

NOTE: *The LC6000 lead/lag controller and MEGA-TEC Series wall-mount units are designed specifically to work together. The controller cannot run other brands of systems, nor can other controllers run the MEGA-TEC Series wall-mount units. They are a complete system, and must be used together.*

Wall-Mount Air Conditioner Units

The wall-mount units operate on VAC power. The units will supply 100% of rated cooling airflow in free cooling mode with ability to exhaust the same amount through the unit itself without any additional relief openings in the shelter.

Each of these units are fully charged with refrigerant and have optional auxiliary heat.

General

The equipment covered in this manual is to be installed by trained, experienced service and installation technicians.

The refrigerant system is completely assembled and charged. All internal wiring is complete.

The unit is designed for use without duct work. Flanges are provided for transition from unit to wall grilles.

These instructions explain the recommended method to install the air cooled self-contained unit and the electrical wiring connections to the unit.

These instructions and any instructions packaged with any separate equipment required to make up the entire air conditioning system should be carefully read before beginning the installation. Note particularly any tags and/or labels attached to the equipment.

While these instructions are intended as a general recommended guide, they do not supersede any national and/or local codes in any way. Authorities having jurisdiction should be consulted before the installation is made. See **Additional Publications** for information on codes and standards.

Sizing of systems for proposed installation should be based on heat loss and heat gain calculations made according to methods of Air Conditioning Contractors of America (ACCA). The supply flange should be installed in accordance with the *Standards of the National Fire Protection Association for the Installation of Air*

Conditioning and Ventilating Systems of Other Than Residence Type, NFPA No. 90A, and Residence Type Warm Air Heating and Air Conditioning Systems, NFPA No. 90B. Where local regulations are at a variance with instructions, installer should adhere to local codes.

Shipping Damage

Upon receipt of equipment, the cartons should be checked for external signs of shipping damage. If damage is found, the receiving party must contact the last carrier immediately, preferably in writing, requesting inspection by the carrier's agent.

These units must remain in upright position at all times; do not lay on side. Do not stack units.

Additional Publications

These publications can help when installing the air conditioner. They can usually be found at the local library or purchased directly from the publisher. Be sure to consult the current edition of each standard.

National Electrical CodeANSI/NFPA 70
Standard for the Installation of Air Conditioning
and Ventilating SystemsANSI/NFPA 90A
Standard for Warm Air Heating
and Air Conditioning SystemsANSI/NFPA 90B
Load Calculation for Residential Winter
and Summer Air Conditioning ACCA Manual J

For more information, contact these publishers:

Air Conditioning Contractors of America (ACCA)
1712 New Hampshire Ave. N.W.
Washington, DC 20009
Telephone: (202) 483-9370 Fax: (202) 234-4721

American National Standards Institute (ANSI)
11 West Street, 13th Floor
New York, NY 10036
Telephone: (212) 642-4900 Fax: (212) 302-1286

**American Society of Heating, Refrigeration and Air
Conditioning Engineers, Inc. (ASHRAE)**
1791 Tullie Circle, N.E.
Atlanta, GA 30329-2305
Telephone: (404) 636-8400 Fax: (404) 321-5478

National Fire Protection Association (NFPA)
Batterymarch Park
P. O. Box 9101
Quincy, MA 02269-9901
Telephone: (800) 344-3555 Fax: (617) 984-7057

ANSI Z535.5 Definitions:

DANGER: Indicate[s] a hazardous situation which, if not avoided, will result in death or serious injury. The signal word “DANGER” is to be limited to the most extreme situations. DANGER [signs] should not be used for property damage hazards unless personal injury risk appropriate to these levels is also involved.

WARNING: Indicate[s] a hazardous situation which, if not avoided, could result in death or serious injury. WARNING [signs] should not be used for property damage hazards unless personal injury risk appropriate to this level is also involved.

CAUTION: Indicate[s] a hazardous situation which, if not avoided, could result in minor or moderate injury. CAUTION [signs] without a safety alert symbol may be used to alert against unsafe practices that can result in property damage only.

NOTICE: [this header is] preferred to address practices not related to personal injury. The safety alert symbol shall not be used with this signal word. As an alternative to “NOTICE” the word “CAUTION” without the safety alert symbol may be used to indicate a message not related to personal injury.



WARNING

Electrical shock hazard.

Have a properly trained individual perform these tasks.

Failure to do so could result in electric shock or death.

WARNING

Fire hazard.

Maintain minimum 1/4" clearance between the supply flange and combustible materials.

Failure to do so could result in fire causing damage, injury or death.

WARNING

Heavy item hazard.

Use more than one person to handle unit.

Failure to do so could result in unit damage or serious injury.

CAUTION

Cut hazard.

Wear gloves to avoid contact with sharp edges.

Failure to do so could result in personal injury.

IMPORTANT

When connecting this product from a remote location, ensure that the network connection is secure and reliable.

USING THE TEC-EYE™

FIGURE 1
TEC-EYE (Bard P/N 8301-059) Display and Interface (Status Screen Shown)



- ALARM KEY**
Allows viewing of active alarms
Silences audible alarms
Resets active alarms
- MENU KEY**
Allows entry to Main Menu
- ESCAPE KEY**
Returns to previous menu level
Cancels a changed entry

- UP KEY**
Steps to next screen in the display menu
Changes (increases) the value of a modifiable field
- ENTER KEY**
Accepts current value of a modifiable field
Advances cursor
- DOWN KEY**
Steps back to previous screen in the display menu
Changes (decreases) the value of a modifiable field

TEC-EYE Hand-Held Service Tool

The TEC-EYE service tool is used to communicate with the MEGA-TEC unit logic board. By connecting directly to the logic board inside the unit control panel, it is possible to perform diagnostics on the unit, adjust certain settings and verify unit and economizer operation through a run test procedure. **The TEC-EYE service tool is required for unit setup and operation.** The TEC-EYE is supplied with the LC6000 controller but can also be ordered separately (Bard P/N 8301-059).

The menu driven interface provides users the ability to scroll through two menu levels: Quick Menu and Main Menu. The menus permit the user to easily view, control and configure the unit. See Figure 1 for TEC-EYE display and key functions.

The controller is completely programmed at the factory; the default setpoints and their ranges are easily viewed and adjusted from the TEC-EYE display. The program and operating parameters are permanently stored on FLASH-MEMORY in case of power failure.

The TEC-EYE connects to the wall-mount unit control board via an RJ11 modular phone connector as shown in Figure 2.

FIGURE 2
TEC-EYE Connection to Unit Control

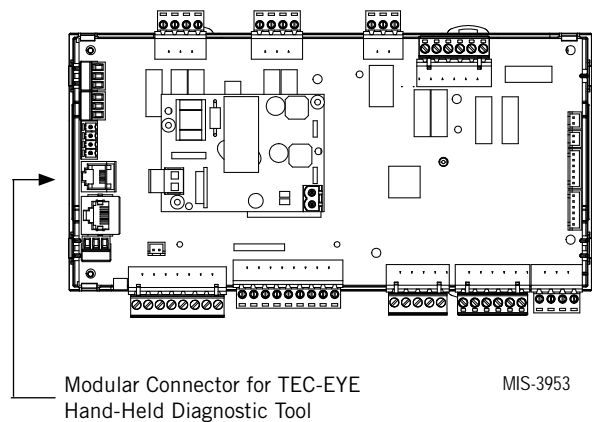

When not being used, the TEC-EYE hand-held diagnostic tool should be stored inside or near the LC6000 controller. Do not let the TEC-EYE leave the shelter.

NOTE: Screenshots shown in this manual reflect default settings (when applicable).

TEC-EYE Menu Structure

Quick Menu

- Setpoints
- Information
- Alarm Log

Main Menu

- System Configuration
- Advanced System Configuration
- I/O Configuration
 - Digital Inputs
 - Digital Outputs
 - Analog Inputs
 - Analog Outputs
 - Fans/Blowers
 - Manual EEV
- On/Off
- Alarm Logs
- Settings
 - Date/Time
 - Password Change
 - Initialization
- Logout

In addition to the menu structure above, there are also Status and Alarm screens.

TEC-EYE Acronyms

- MAT – Mixed air temperature
- RAT – Return air temperature
- SAT – Supply air temperature
- OAT – Outdoor air temperature
- OAH – Outdoor air humidity
- Blower – Indoor blower speed
- Fan – Outdoor fan speed
- Econ – Free cooling

NOTE: *Digital refers to On/Off whereas analog is a variable input.*

Main Status Screen

The main Status screen is the default start-up screen and also the return screen after 5 minutes of no activity. The screen can be accessed at any time by pressing the ESCAPE key repeatedly.

The wall-mount unit address is displayed in the upper right corner on the main Status screen (see Figure 1). The main Status screen also shows the current date, time, mixed air temperature (MAT), return air temperature (RAT), supply air temperature (SAT), outdoor air temperature (OAT) and outdoor air humidity (OAH). Blower speed, condenser fan speed, damper position and unit status are also displayed. See Table 1 for wall-mount unit status messages.

The Quick Menu is accessible from the main Status screen. Setpoints, Information and Alarm Log are available through the Quick Menu. Pressing the UP or DOWN keys while on the main Status screen will change the Quick Menu icon displayed (see Figure 3 on

page 8). Press the ENTER key when the desired icon is displayed.

TABLE 1
Unit Status Messages

Message	Description
Waiting...	PLC is on and has not started running the application yet.
Orphan Mode	Unit is on and in orphan mode with no calls for heating or cooling.
LC Online	Unit is on and communicating with the LC6000 with no heating or cooling calls.
Cont. Blower	Unit is operating with continuous blower when no heating or cooling calls are present.
Freecooling	Unit is actively economizing.
Optimized Cool	Unit is mechanical cooling while actively economizing.
Cooling	Unit is actively mechanical cooling.
Heating	Unit is actively heating.
Passive Dehum	Unit is taking measures to decrease humidity without using extra energy.
Active Dehum	Unit is currently in active dehumidification mode and will be utilizing electric reheat to reduce the humidity level in the space.
Self Test	Unit is performing a run test.
Off by Alarm	Unit has major fault preventing operation.
Off by LC	Unit has been turned off by the supervisory controller.
Off by Keyboard	Unit has been turned off by the local user.
Emergency Vent	Unit is in Emergency Ventilation. LC6000 has an active hydrogen alarm.
Emergency Cool	Unit is in Emergency Cooling. Indoor temperatures have exceeded high temp alarms.
Emergency Off	Unit is in Emergency Off. LC6000 has an active smoke alarm.

FIGURE 3
Quick Menu Icons



Quick Menu

Setpoints

From this screen, the local unit heating and cooling setpoints, used for orphan mode only, can be changed.

Once the supervisory controller is connected, cooling and heating setpoints will be communicated and local cooling and heating setpoints will be replaced with the communicated cooling and heating setpoints.

If at any time the wall-mount unit(s) loses communication with the LC6000 controller, the wall-mount unit(s) will go into orphan mode and operate using the last communicated setpoints.

To verify or change the wall-mount unit cooling and heating setpoints in orphan mode:

1. Connect the TEC-EYE diagnostic tool to the control board located in the unit.
2. From the Status screen, press UP or DOWN key until Quick Menu displays Setpoints icon. Press ENTER key.
3. Press ENTER key to scroll to the selected choice (see Figure 4).
4. Press UP or DOWN key on desired value until value displays correctly.
5. Press ENTER key to save and scroll to next parameter.
6. Press ESCAPE key until Main Menu screen is displayed.

FIGURE 4
Cool and Heat Setpoints

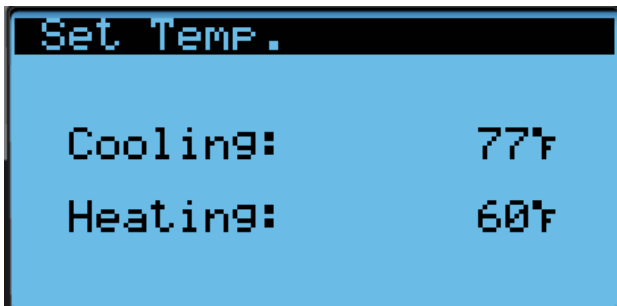

Information

The information screens are used as a quick reference to show unit A/C circuit measurements and program version.

A/C Circuit Information

MEGA-TEC Series wall-mounted air conditioners have two separate refrigeration circuits: Circuit 1 is located on the left side of the unit and circuit 2 is on the right side (see Figure 5).

Circuit 1 uses a 2 stage scroll compressor and electronic expansion valve along with high and low pressure transducers. Suction temperature is also measured to provide superheat of circuit 2. Circuit 2 uses a single stage compressor and electronic expansion valve along with high and low pressure transducers. Suction temperature is also measured to provide superheat of circuit 1.

Using both circuit 1 and circuit 2, the MEGA-TEC unit can provide 35%, 80%, and 100% cooling capacity. Separate refrigeration circuits also allow for operation of the unit at partial capacity if service is required on one circuit.

FIGURE 5
MEGA-TEC Refrigeration Circuits

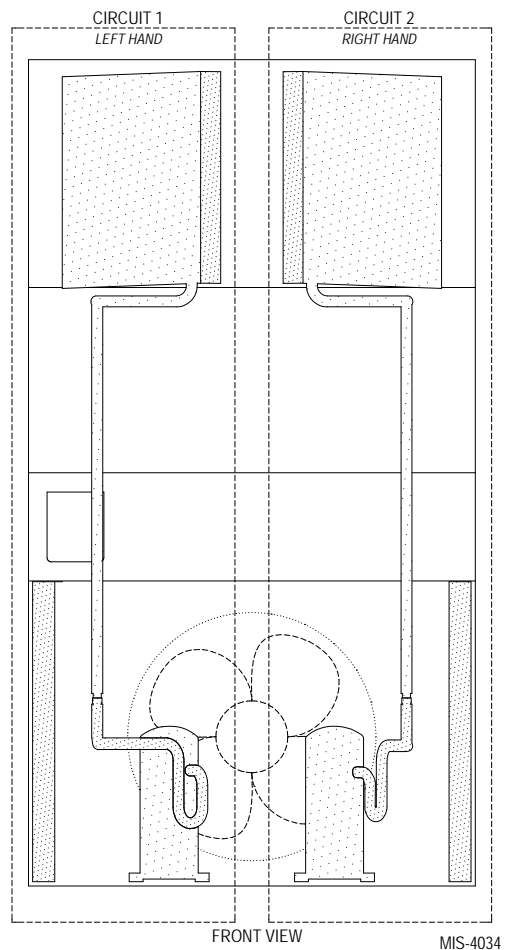

A/C Circuit Information can be found in four screens within the information menu (see Figure 6). The information and measurements provided are liquid line

temperature, liquid line pressure, condensing saturated temperature, suction line temperature, suction line pressures, suction saturated temperature, super heat, subcooling and electronic expansion valve position.

FIGURE 6
A/C Circuit Measurements

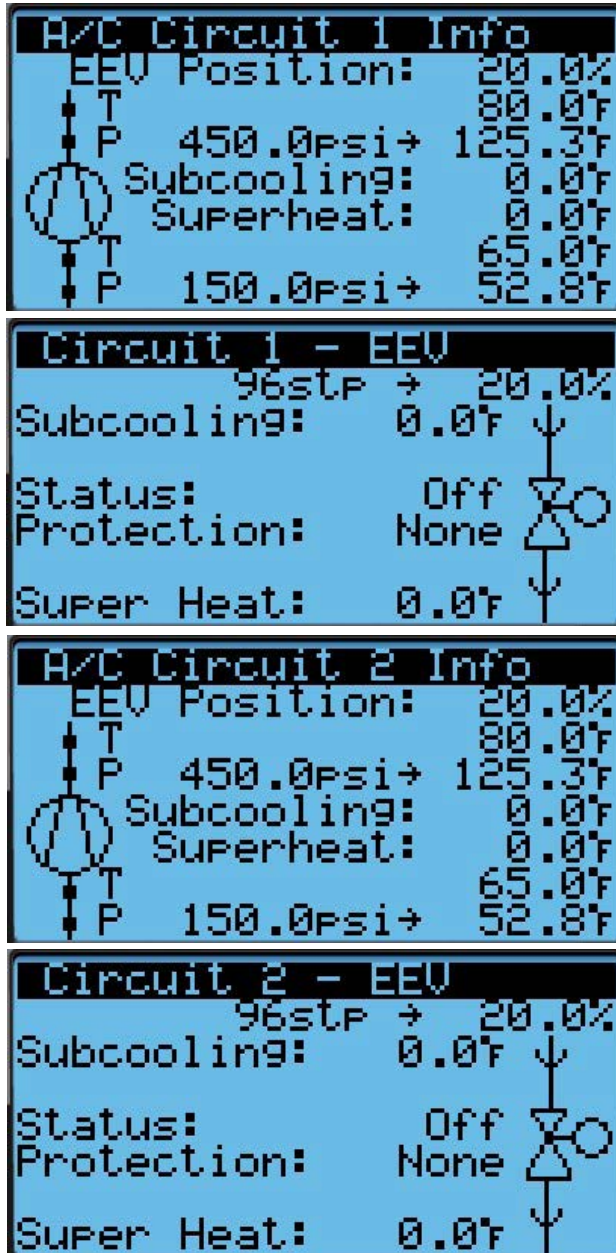

Program Version

The Program Version screen displays the model number of the unit as well as all program version information for the PLC (see Figure 7). This information can be used to determine whether a software update may be required based on information found in the software change log. This change log can be found at <http://www.bardhvac.com/software-download/>.

FIGURE 7
Program Version

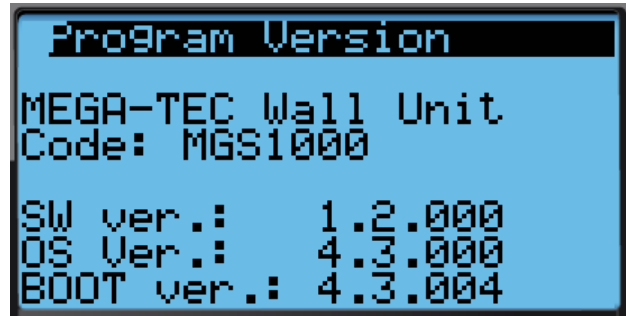

Software Versioning Guide

MGS1000.x.y.z

Software Name: The name of the software is the base part number used to identify which product the software is used in.

TABLE 2
Software Versioning Guide

Product	Software Name
MULTI-TEC	MTS1000
FUSION-TEC (WR)	WTS1000
MEGA-TEC	MGS1000
LC6000	LCS6000

X: The letter X represents a major change to the software effecting product compatibility or function of the equipment.

Y: The letter Y represents a minor change to the software that either adds, removes, or alters a feature of the equipment without effecting compatibility with other products.

Z: The letter Z represents a change to the software that fixes existing features or user interface.

NOTICE

It is important to check the software version during installation to ensure that the latest version has been installed. Current software versions, change log and installation instructions are available on the Bard website at <http://www.bardhvac.com/software-download/>

Alarm Log

The alarm log screens show a log of each alarm. There will be a log for when alarm occurred and if the alarm auto clears, it will show when the alarm cleared. See page 11 for information on clearing alarms.

Menu Screens and Password Levels

- A** System Config: A1-A5 User (2000)
- B** Adv Sys Config: B1-B4 Technician (1313)
- C** I/O Config: Technician (1313)
- D** On/Off: User (2000)
- E** Alarm Logs: User (1313)
- F** Settings
 - Date/Time: Technician (1313)
 - Password Change
 - Initialization
 - Alarm Initialization: User (2000)
 - Default Installation: Engineer (9254)
 - Parameters Import/Export: Engineer (9254)
 - Alarm Export: User (2000)
- G** Logout: Used to log out of the current password level. Entering back into the menu requires password.

TABLE 3
LC6000/TEC-EYE Passwords (Defaults)

User	2000
Technician	1313
Engineer	9254
Use UP or DOWN keys and ENTER key to enter password	

The passwords listed above are the default passwords. End users can change these passwords if additional security is desired.

Executing a Self Test

This unit has the ability to perform a self test that will operate all available unit functions in order to quickly determine unit operation. Some unit parameters are adjustable.

To execute a self test:

1. Press MENU key to access the Main Menu screen.
2. Press UP or DOWN keys and ENTER key to enter TECHNICIAN password 1313.
3. Press UP or DOWN keys to scroll to **Sys Config**; press ENTER key.
4. Press UP or DOWN keys to scroll to **Self Test A10** screen.
5. Press ENTER key to scroll to **Enable** parameter (see Figure 8).
6. Press UP or DOWN key to change value to **Yes**. The self test will begin.

FIGURE 8
Executing Self Test

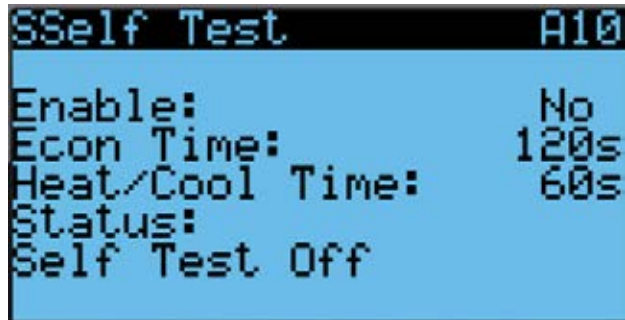

Self Test Parameter Descriptions

Econ Stage Time: Amount of time (in seconds) allowed for damper blade movement in each direction.

Heat/Cool Stage Time: Amount of time (in seconds) allowed for each stage of heating or cooling.

Reset to Factory Defaults

To reset to factory default settings:

1. Press MENU key to go to the Main Menu screen.
2. Use UP or DOWN keys and ENTER key to enter ENGINEER password 9254.
3. Press UP or DOWN keys to scroll to **Settings**; press ENTER key.
4. Press UP or DOWN keys to scroll to **Initialization**; press ENTER key.
5. Press UP or DOWN keys to scroll to the **Default Installation** screen.
6. Press ENTER key to scroll to **Wipe retain mem.** (see Figure 9).
7. Press UP or DOWN key to change value to **YES**; press ENTER key.
8. System will restart with default values.

FIGURE 9
Restoring Factory Default Settings



NOTE: Screenshots shown in this manual reflect default settings (when applicable).

Unit On/Off

The wall-mount unit can be turned on and off from the TEC-EYE. Turning the unit off with the following instructions will disable all unit operation.

To turn the unit on or off:

1. Press MENU key to go to the Main Menu screen.
2. Press UP or DOWN keys and ENTER key to enter USER password 2000.
3. Press UP or DOWN keys to scroll to **On/Off**; press ENTER key.
4. Press UP or DOWN keys to change value from On to Off or from Off to On.
5. Press ESCAPE key several times to return to Main Menu screen.

The wall-mount unit may also be turned off by certain events such as the unit disable input, blower offline, fan offline, panel switch open or the return air temperature sensor failure when not connected to the LC6000.

The unit will also be turned off if the unit loses communication with the expansion board, blower motor, condenser fan motor or panel switch for blower or condenser fan compartment.

Alarm Adjustment

Acknowledging Alarms

On the standard TEC-EYE included with the LC6000 controller (Bard P/N 8301-159), alarm conditions are enunciated by an audible alarm signal. On the larger TEC-EYE (Bard P/N 8301-053), alarm conditions activate a red LED indicator that backlights the ALARM function key. An alarm is acknowledged by pressing the ALARM key. This calls up alarm display screen(s) that provide a text message detailing the alarm condition(s).

Clearing Alarms

Alarms can only be cleared after the alarm condition has been corrected. To clear a single alarm, press and hold the ALARM key for 3 seconds while viewing a specific alarm screen. To clear all alarms, navigate to the screen at the end of the alarm list (shown in Figure 10) and press and hold the ALARM key for 3 seconds.

FIGURE 10
Clearing All Alarms



Clearing Alarm Logs and Counters

To clear the alarm log and alarm counters:

1. Press MENU key to go to the Main Menu screen.
2. Use UP or DOWN keys and ENTER key to enter USER password 2000.
3. Press UP or DOWN keys to scroll to **Settings**; press ENTER key.
4. Press UP or DOWN keys to scroll to **Initialization**; press ENTER key. (**Alarm initialization** screen will be displayed.)
5. Press ENTER key to scroll to **Delete alarm logs?** (see Figure 11).
6. Press UP or DOWN key to change value to **YES**; press ENTER key.
7. Press ENTER key to scroll to **Clear AutoReset counters?**
8. Press UP or DOWN key to value to **YES**; press ENTER key.

FIGURE 11
Clearing Alarm Logs and Counters

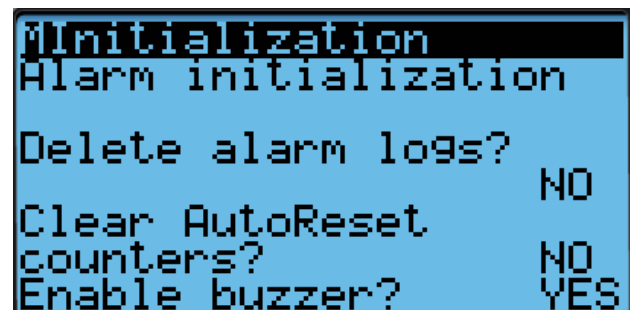

Exporting Alarm Logs

See latest version of Supplemental Instructions manual 7960-825 for information on exporting alarm logs.

Exporting 7 Day Logs

See latest version of Supplemental Instructions manual 7960-826 for information on exporting 7 day I/O logs.

Exporting Parameters

See latest version of Supplemental Instructions manual 7960-827 for information on exporting parameters.

Zone

When paired with a supervisory controller that uses zones to control groups of wall units, this unit uses the zone setting to relay to the supervisory controller what zone it is set to operate in. Up to three zones can be established with up to 14 units in a single zone. (The LC6000 supervisory controller can control up to a total of 14 units.)

To change the zone:

1. Press MENU key to access the Main Menu screen.
2. Press UP or DOWN keys and ENTER key to enter TECHNICIAN password 1313.
3. Press UP or DOWN keys to scroll to **Sys Config**; press ENTER key.
4. Press UP or DOWN keys to scroll to **Unit Setup A1** screen.
5. Press ENTER key to scroll to **Zone** (see Figure 12).
6. Press UP or DOWN keys to change to the desired value (1, 2 or 3).
7. Press ENTER key to save value.

FIGURE 12
Changing Zone



Temperature Control

Temperature Control Components

Return Air Temperature Sensor

The unit is equipped with a return air temperature sensor to monitor the space temperature when the unit is in orphan mode. The return air sensor is located in the upper part of the return opening in such a way that it is exposed to the entering airstream. An alarm signal will be sent to the LC controller if the return air temperature sensor is disconnected. The temperature is measured with a 10k ohm NTC thermistor.

This sensor can be verified and adjusted by:

1. Press MENU key to go to the Main Menu screen.
2. Press UP or DOWN keys and ENTER key to enter TECHNICIAN password 1313.
3. Press UP or DOWN keys to scroll to **I/O Config**; press ENTER key.
4. Press UP or DOWN keys to scroll to **Analog Inputs**; press ENTER key.
5. Press UP or DOWN keys to scroll to **Analog Ins 1/19**.
6. Verify the measurement displayed on screen is accurate (see Figure 13).
7. If the measurement needs to be adjusted, apply an offset value by pressing ENTER to scroll to **Offset**.
8. Press UP or DOWN keys to adjust the offset.
9. The update will not take effect until the cursor is moved out of the **Offset** parameter.
10. Once adjusted, press the ESCAPE key several times to return to Main Menu screen.

FIGURE 13
Adjusting Return Air Temperature Sensor

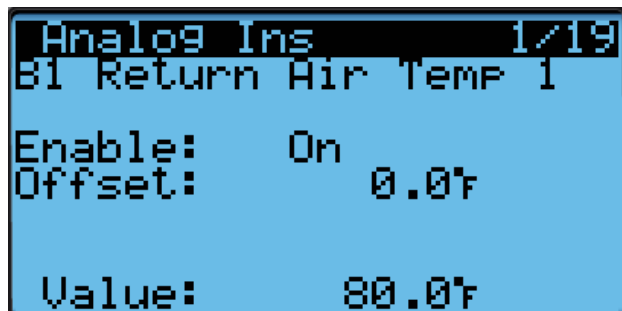

Return Air Temperature Alarm

When the return air temperature sensor value is out of range (-41.0 to 303.0°F), the controller will generate a sensor failure alarm to indicate the sensor is not working properly.

This alarm is fixed and cannot be adjusted.

Temperature Control Operation

The unit utilizes differentials while in orphan mode to control the space temperature. The differential values all reference the setpoint therefore allowing the control band to be easily changed using the setpoint. To change specific staging characteristics, each differential can be modified individually. There are separate setpoints and differentials for cooling and heating. Specific to the cooling differentials, the economizer will always be utilized first on a cooling call unless outdoor conditions are not acceptable for free cooling. In this case, the compressor will be activated at stage 1 in place of the economizer. All remaining stages will be shifted until the economizer becomes available again.

To change or view the unit setpoint:

1. From the Status screen, press UP or DOWN key until Quick Menu displays Setpoints icon (). Press ENTER key.
2. Press ENTER key to scroll to **Cool Setpoint** or **Heat Setpoint** (see Figure 4 on page 8).
3. Press UP or DOWN keys to change the value to desired heating and/or cooling setpoint.

Orphan Mode

MEGA-TEC Series wall-mount units have the capability to run without the LC6000 controller attached—this feature is called orphan mode. This keeps the shelter between 60°F and 77°F (factory default settings) by the use of the factory-installed return air sensor in each wall-mount unit. In orphan mode, no auxiliary temperature measurement devices are required for operation. The wall-mount unit automatically uses a continuous blower setting to circulate room air into the return air inlet and uses the return air temperature sensor to control room temperature.

If at any time the wall-mount unit(s) loses communication with the LC6000 controller, the wall-mount unit(s) will go into orphan mode and operate using the last communicated setpoints.

To change default setpoints, refer to **Setpoints** on page 8.

During installation, the ability to run in orphan mode allows deactivation of one of the existing, older wall-mount units, while keeping the shelter cool with the other unit still operating. Once the first of the Bard wall-mount units is installed and powered on, it will

operate in orphan mode—keeping the climate inside the shelter stable and the installers comfortable while the remainder of the older equipment is removed and the remaining Bard wall-mount units and LC6000 controller are installed.

Additionally, should any or all of the MEGA-TEC Series wall-mount units lose communication with the LC6000 controller (such as during maintenance), they will continue to serve the shelter’s needs until a repair can be made.

LC6000 Control

When the unit is connected to a LC6000 supervisory controller, the cooling and heating stages will be controlled by the LC6000. For more information on LC6000 staging, see latest version of LC6000 Service Instructions 2100-669.

Cooling (with Economizer)

If equipped with an economizer, the unit is equipped with 1 stage of free cooling and 3 stages of mechanical cooling for a total of 4 cooling stages (see Figure 14).

Cooling (without Economizer)

In a situation where the unit is either not equipped with an economizer or is equipped with an economizer but the outdoor conditions are not favorable for economizer operation, the staging will use Stage 1, 2 or 3 differentials (see Figure 15 on page 14).

Heating

The unit can be equipped with 0, 1 or 2 stages of electric heat (see Figure 16 on page 14).

FIGURE 14
Cooling (with Economizer)

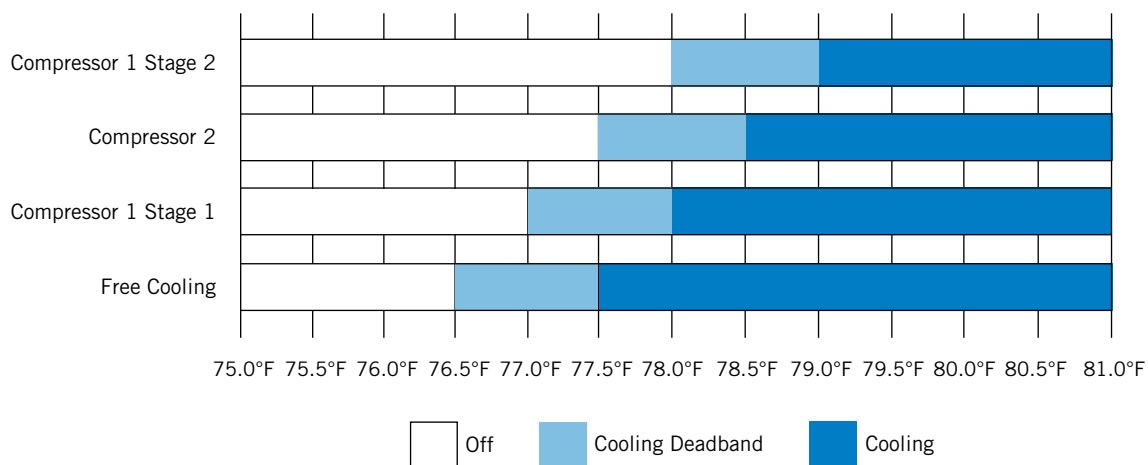

FIGURE 15
Cooling (without Economizer)

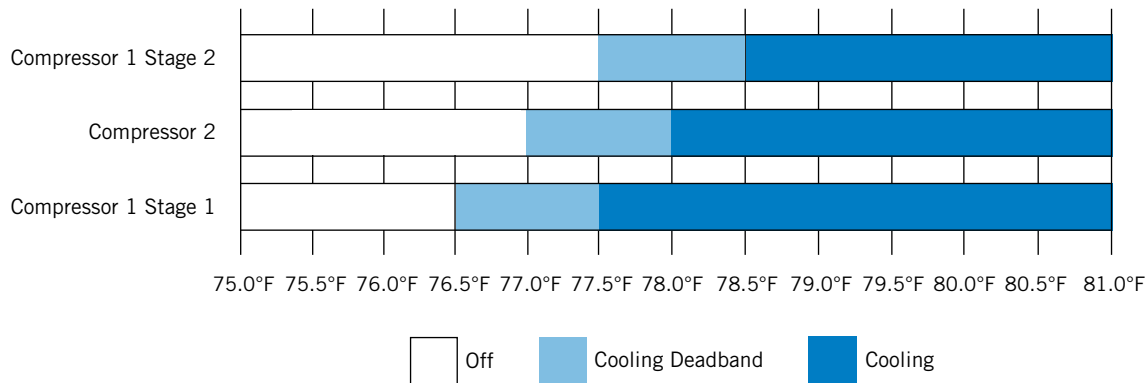
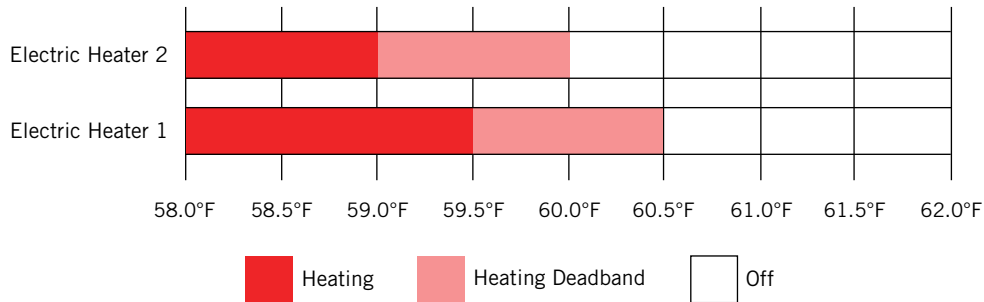

FIGURE 16
Heating



Electronic Expansion Valve (EEV)

EEV Components

Electronic Expansion Valve

The electronic expansion valve is a stepper motor that is controlled with a step output from the controller. The valve is capable of 480 steps represented by a 0-100% signal on the controller. The motor drives a needle valve that regulates the flow of refrigerant.

EEV Instructions for Vacuum, Reclaim, Charge Unit

The electronic expansion valve moves to the 20% open position when the unit is not actively cooling. The valve may need to be manually positioned for service or troubleshooting. The valve can be positioned by using a menu override.

To manually override the valve:

NOTE: The unit must be off to perform this override.

1. Press MENU key to go to the Main Menu screen.
2. Press UP or DOWN keys and ENTER key to enter TECHNICIAN password 1313.
3. Press UP or DOWN keys to scroll to **I/O Config**; press ENTER key.

4. Press UP or DOWN keys to scroll to **Manual EEV**; press ENTER key.
5. Press UP or DOWN keys to scroll to **EEV Circuit 1** or **EEV Circuit 2**.
6. Press ENTER key to scroll to **Service Pos** (see Figure 17).
7. Press UP or DOWN keys to adjust to the desired value.
8. Press ENTER key to scroll to **Enable**.
9. Press UP or DOWN key to change **Off** to **On**.
10. Press ENTER key to save.

FIGURE 17
Overriding EEV Output

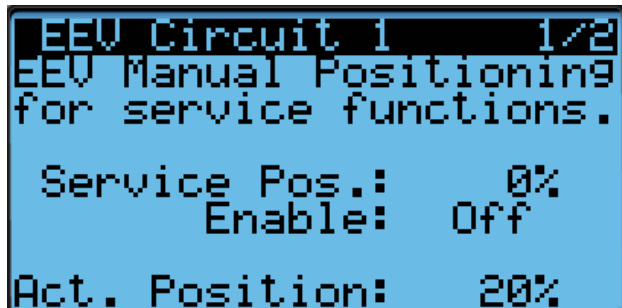

The valve can also be opened or closed using the EEV service tool (Bard Part # 2151-021). This magnetic EEV service tool (shown in Figure 18) is used to manually open the EEV. To do this, remove the EEV stator coil (red color with retaining nut on top), slide the magnetic tool over the shaft where the stator was removed and turn in a clockwise direction to open the valve to the full open position (directional arrows are provided on the tool). Opening the valve to the full open position will aid in the refrigerant reclamation and evacuation processes.

With the stator removed, the resistance should be 40 ohms +/- 10%. There are two sets of three wires that will have this resistance.

After removing the EEV service tool, reapply the EEV stator coil and retaining nut. Upon powering the unit back up, the control board will automatically drive the EEV back to the fully shut position, and then back to the 20% open position prior to starting the compressor back up. Once the compressor starts, the control board will again modulate the EEV position to control the system superheat.

FIGURE 18
Electronic Expansion Valve (EEV) and Service Tool

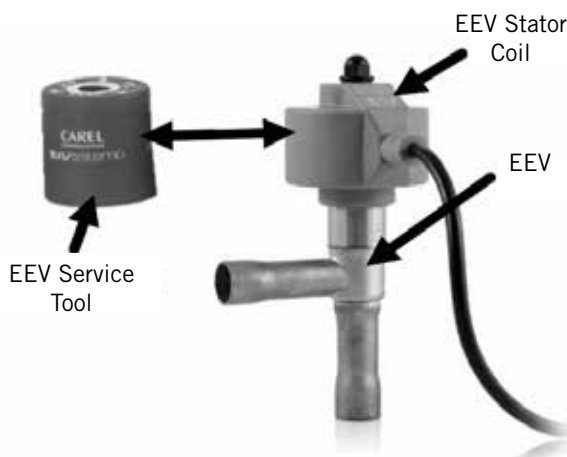

System Pressures

To view system pressure and temperatures during this process:

1. From the Status screen, press UP or DOWN key until Quick Menu displays Unit Information icon (). Press ENTER key.
2. Press UP or DOWN keys to scroll to **A/C Circuit 1 Info** and **A/C Circuit 2 Info** screens (see A/C Circuit Measurements on page 8).

Suction Pressure Transducer

The unit has pressure transducers installed on the suction line between the evaporator coil and compressor (one on refrigerant circuit 1 and one on refrigerant circuit 2). The transducer is used for system monitoring of suction system pressures. The transducer

is used with the suction temperature sensor to provide a real time superheat calculation that determines the EEV position.

This transducer reading can be verified and adjusted by:

1. Press MENU key to go to the Main Menu screen.
2. Press UP or DOWN keys and ENTER key to enter TECHNICIAN password 1313.
3. Press UP or DOWN keys to scroll to **I/O Config**; press ENTER key.
4. Press UP or DOWN keys to scroll to **Analog Inputs**; press ENTER key.
5. Press UP or DOWN keys to scroll to **Analog Ins 6/19** (for circuit 1) or **Analog Ins 8/19** (for circuit 2).
6. Verify the measurement displayed on screen is accurate (see Figure 19).
7. If the measurement needs to be adjusted, apply an offset value by pressing ENTER to scroll to **Offset**.
8. Press UP or DOWN keys to adjust the offset.
9. The update will not take effect until the cursor is moved out of the **Offset** parameter.
10. Once adjusted, press the ESCAPE key several times to return to Main Menu screen.

FIGURE 19
Adjusting Suction Sensor/Transducer Pressure Values

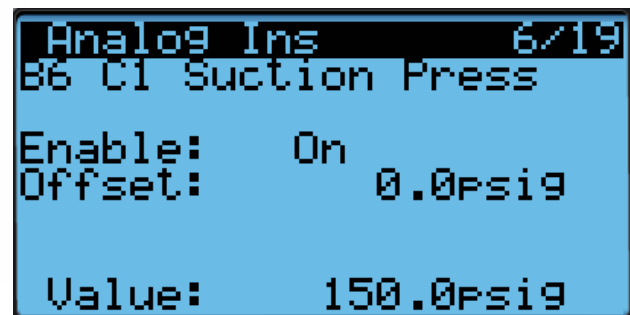

Troubleshooting the Suction Pressure Transducer

0-250 psig

-5v Nominal, .5 – 4.5v Actual

4v/250 psig = .016 volts per 1 psig

Example: 125 psig x .016 + .5 volts = 2.5 volts

Formula for Tech:

Measured Pressure x .016 + Voltage Offset = Expected Transducer Signal Voltage (see Figure 20 on page 16).

FIGURE 20
Voltage to Pressure: Suction Pressure Transducer

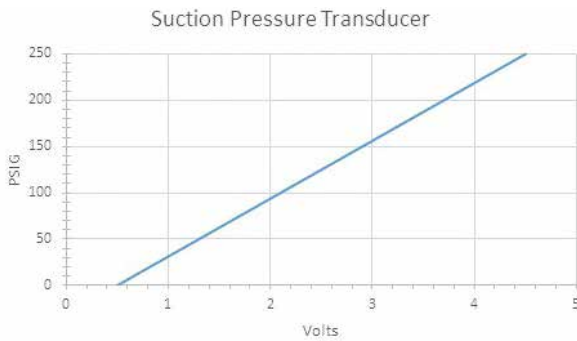

Suction Pressure Alarm

When the suction pressure transducer value is measured out of range (0-250 PSIG) and the compressor has been operating for longer than 1 minute, the controller will generate a sensor failure alarm to indicate the sensor is not working properly.

This alarm cannot be adjusted.

Suction Temperature Sensor

The suction temperature sensor is used to calculate superheat. The EEV uses this value to control the EEV. The temperature is measured with a 10k ohm NTC thermistor.

The suction temperature sensor measurement can be verified and adjusted by:

1. Press MENU key to go to the Main Menu screen.
2. Press UP or DOWN keys and ENTER key to enter TECHNICIAN password 1313.
3. Press UP or DOWN keys to scroll to **I/O Config**; press ENTER key.
4. Press UP or DOWN keys to scroll to **Analog Inputs**; press ENTER key.
5. Press UP or DOWN keys to scroll to **Analog Ins 10/19** (for circuit 1) or **Analog Ins 11/19** (for circuit 2).
6. Verify the measurement displayed on screen is accurate (see Figure 21).
7. If the measurement needs to be adjusted, apply an offset value by pressing ENTER to scroll to **Offset**.
8. Press UP or DOWN keys to adjust the offset.
9. The update will not take effect until the cursor is moved out of the **Offset** parameter.

FIGURE 21
Adjusting Suction Temperature Sensor Values

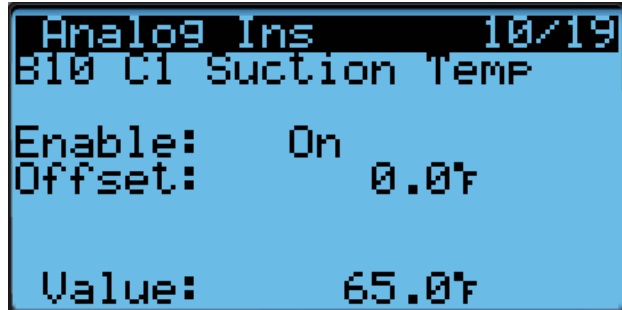

Suction Temperature Alarm

When the suction temperature sensor value is out of range (-41.0 to 303.0°F), the controller will generate a sensor failure alarm to indicate the sensor is not working properly.

This alarm cannot be adjusted.

Evaporator Freeze Condition Alarm

The freeze condition alarm uses a temperature sensor attached to the evaporator coil to determine if the evaporator is cold enough to potentially start building ice. The controller will generate this alarm when the compressor is running and the coil temperature is below 32°F for 2 minutes. While the alarm is active, the compressor will be deactivated and the blower speed will be set to 80%. The evaporator temperature needs to warm back up to the reset temperature of 55°F or 5 minutes must pass before the alarm will clear and the compressor will be permitted to run again.

The evaporator freeze sensor measurement can be verified and adjusted by:

1. Press MENU key to go to the Main Menu screen.
2. Press UP or DOWN keys and ENTER key to enter TECHNICIAN password 1313.
3. Press UP or DOWN keys to scroll to **I/O Config**; press ENTER key.
4. Press UP or DOWN keys to scroll to **Analog Inputs**; press ENTER key.
5. Press UP or DOWN keys to scroll to **Analog Ins 13/19** (for circuit 1) or **Analog Ins 14/19** (for circuit 2).
6. Verify the measurement displayed on screen is accurate (see Figure 22).
7. If the measurement needs to be adjusted, apply an offset value by pressing ENTER to scroll to **Offset**.
8. Press UP or DOWN keys to adjust the offset.
9. The update will not take effect until the cursor is moved out of the **Offset** parameter.

FIGURE 22
Adjusting Evaporator Freeze Sensor Values

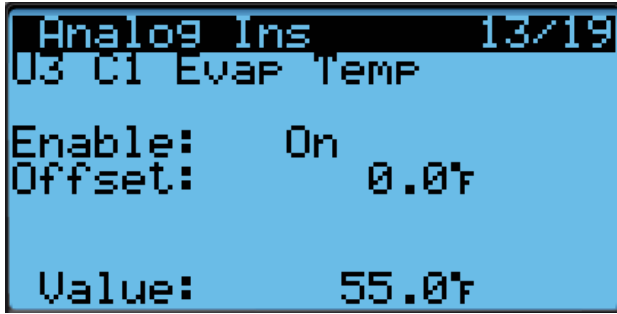

EEV Operation

EEV Superheat Control

The electronic expansion valve (EEV) will open or close to maintain the superheat setpoint while the compressor is running (see Table 4). When the compressor is not running, the valve will close to the 20% open default position.

TABLE 4
Unit Specific Superheat Setpoints

Unit	Superheat
W090A	14°F
W120A	10°F

Low superheat protection will be active once the superheat value is at or below 5°F. At this point, the control will aggressively close the valve so that superheat is maintained.

Additional EEV Alarms

Low Superheat Alarm

This alarm will become active when the calculated superheat goes below 5°F. This alarm will clear itself when the condition is no longer present.

This alarm cannot be adjusted.

Indoor Airflow

Indoor Airflow Components

Blower

The unit is equipped with a blower that is driven by an electronically commutated motor (ECM). The blower is controlled by a 0-100% signal through Modbus communication. The motor controller converts this signal to a PWM signal. The blower uses a 22" (560 mm) diameter wheel and operates up to 1500 rpm.

The blower output can be put into an override mode for verification or troubleshooting.

To put the blower into override:

1. Press MENU key to go to the Main Menu screen.
2. Press UP or DOWN keys and ENTER key to enter TECHNICIAN password 1313.
3. Press UP or DOWN keys to scroll to **I/O Config**; press ENTER key.
4. Press UP or DOWN keys to scroll to **Fans / Blowers**; press ENTER key.
5. Press UP or DOWN keys to scroll to **Blower 1**.
6. Press ENTER key to scroll to **Blower Overrides?** (see Figure 23).
7. Press UP or DOWN key to change **No** to **Go**. The override will begin and the screen will change to the override screen (see Figure 23).

The override will last for 5 minutes or until the **Blower Overrides** parameter is set to **No** again.

FIGURE 23
Putting Blower Output into Override Mode

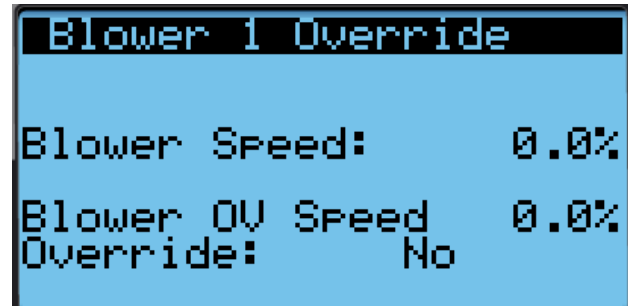
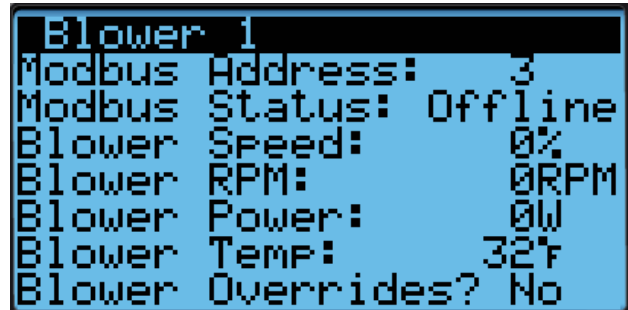

TABLE 5
Rated Airflow

	Nominal Rated CFM		Nominal Rated ESP
	High	Low	
W090A	3000	2100	0.25
W120A	4000	2800	0.30

TABLE 6
Indoor Blower Performance

	ESP (Inch H ₂ O)	Dry Coil	Wet Coil
W090A	0.25	2790	2850
W120A	0.30	4160	3890

TABLE 7
Maximum ESP of Operation
Electric Heat Only

Model	Static Pressure ("WC)*
-B0Z	.50"
-B09	.50"
-B18	.50"
-C0Z	.50"
-C09	.50"
-C18	.50"

* Unit is rated for free blow non-ducted operation with SG-10W Supply Grille and RG-10W Return Grille.

Blower Status Switch

The unit is equipped with a differential pressure airflow switch to monitor the blower (see Figure 24). If the blower is turned on and the switch doesn't close to indicate there is differential pressure between the inlet and outlet of the blower, an alarm will be generated. For switch settings, see Figure 24.

FIGURE 24
Dirty Filter Switch and Blower Status Switch

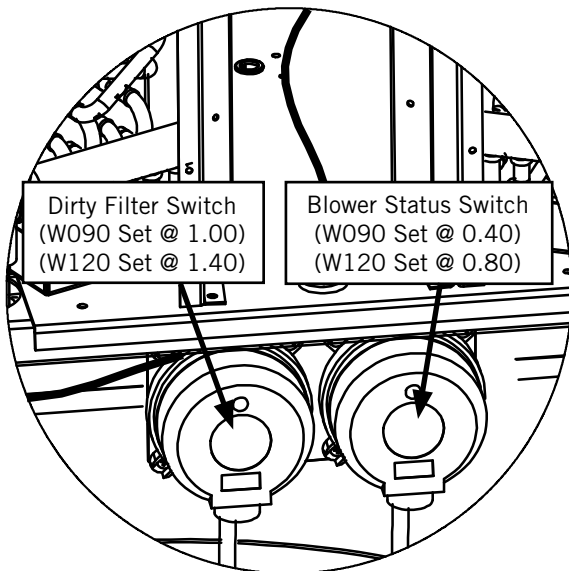

Differential airflow status can be viewed by:

1. Press MENU key to go to the Main Menu screen.
2. Press UP or DOWN keys and ENTER key to enter TECHNICIAN password 1313.
3. Press UP or DOWN keys to scroll to **I/O Config**; press ENTER key.
4. Press UP or DOWN keys to scroll to **Digital Inputs**; press ENTER key.
5. Reference **Airflw 1** row and **Val** column (see Figure 25).

FIGURE 25
Verifying Differential Airflow Status

Digital Ins	En	Dir	Val
Channel	En	Dir	Val
Disable	Yes	N/C	Off
CCM1	Yes	N/O	Off
CCM2	Yes	N/O	Off
Airflw 1	Yes	N/O	On
Airflw 2	No	N/O	On
Filter 1	Yes	N/O	Off

Blower Status Alarm

When the blower is on for 45 seconds and no airflow is detected by the airflow switch, the compressor and heating operations will be disabled. The system will wait 5 minutes before trying again. After three consecutive no airflow events, the system will generate an alarm and lockout requiring a user reset.

Filters

The unit is equipped with four (4) 20" x 24" x 2" MERV 8 filters (two per coil). The filters lift and slide into position making them easy to service. The filters can be serviced by opening the "hinged" front access panel and locking it into position. Then lift and slide into position as needed.

Dirty Filter Switch

These units are equipped with a differential pressure switch to indicate when the filter(s) needs to be replaced (see Figure 24). The dirty filter switch measures the pressure difference across the filter through silicone tubing routed to the blower and evaporator areas of the unit.

The switch circuit consists of a *normally open* filter pressure switch. The switch will open when the pressure differential goes above the setting indicated on the dial. When the pressure difference returns below the setting on the dial, the switch will close.

Adjustment of dirty filter switch may be necessary to ensure proper operation. See Figure 26 to aid in setting the filter switch to operate at different percentages of filter blockage.

Dirty Filter Alarm

The wall-mount unit is equipped with a differential pressure switch input to the controller. When the switch indicates a dirty filter, the controller will generate an alarm. The alarm will latch once triggered requiring a technician to acknowledge the alarm after replacing filters. Additionally, an indicator light will be turned on with the alarm and turned off when the alarm clears.

The threshold of this alarm is adjusted by changing the settings on the switch (see Figure 26).

Filter Indicator Light

The wall-mount unit is equipped with a 24v indicator light mounted on side of unit that displays the current status of the filter (see Figure 26). When the light is on, the filter needs to be replaced. Once the filter(s) has been changed and the alarm has been cleared, the indicator light will turn off.

Indoor Airflow Operation

Blower Speed Control

The blower is capable of changing speeds to best match the requirements of the system depending on which mode the system is in.

The unit will automatically switch to the required speed for each mode. High sensible mode and dehumidification mode are both communicated separately from the LC. For more information on the high sensible command from LC, please see LC6000 Service Instructions 2100-669.

Additional Indoor Airflow Alarms

Supply Air Temperature Alarm

When the supply air temperature sensor value is out of range (-41.0 to 303.0°F), the controller will generate a sensor failure alarm to indicate the sensor is not working properly.

This alarm is fixed and cannot be adjusted.

FIGURE 26
Dirty Filter Switch and Filter Indicator Light

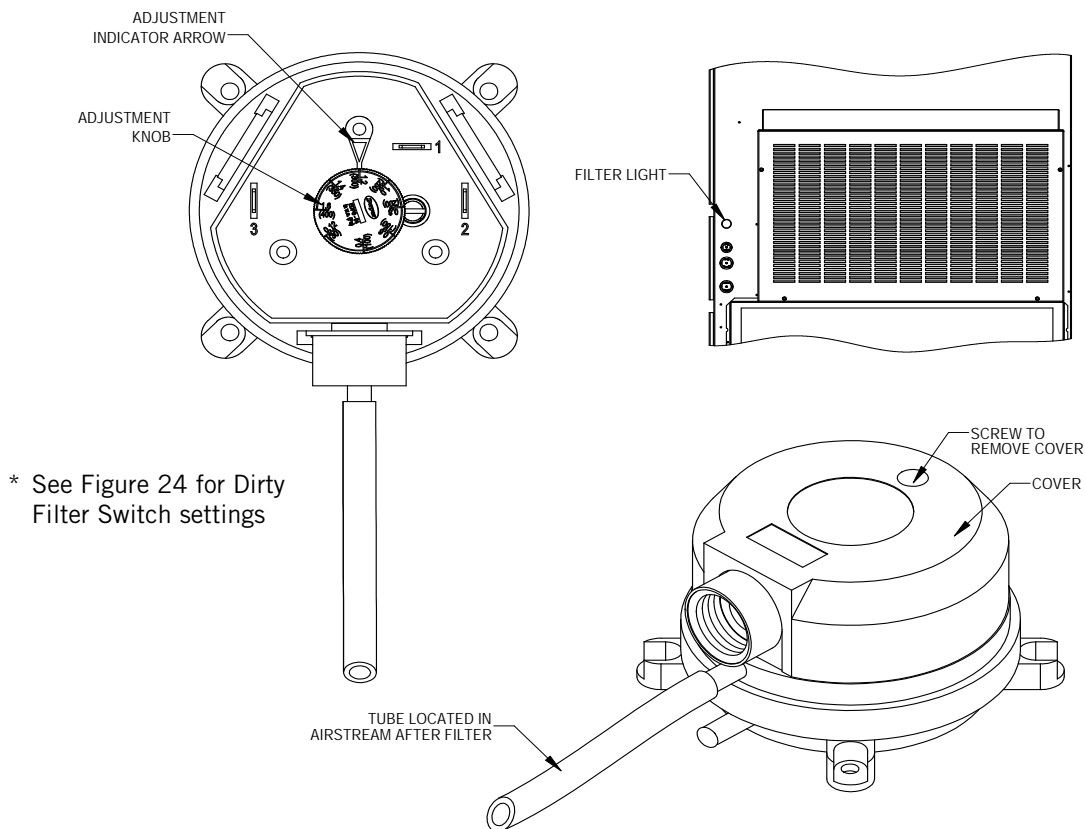

Condenser Fan

Condenser Fan Components

Condenser Fan

The unit is equipped with a condenser fan that is driven by an electronically commutated motor (ECM). This fan is controlled by a 0-100% command using modbus serial communication. The fan operates between 100-1200 rpm.

To enable fan override:

1. Press MENU key to go to the Main Menu screen.
2. Press UP or DOWN keys and ENTER key to enter TECHNICIAN password 1313.
3. Press UP or DOWN keys to scroll to **I/O Config**; press ENTER key.
4. Press UP or DOWN keys to scroll to **Fans / Blowers**; press ENTER key.
5. Press UP or DOWN keys to scroll to **Condenser Fan 1** (see Figure 27).
6. Press ENTER key to scroll to the **Fan Overrides?**
7. Press UP or DOWN keys to change the value from **No** to **Go**. The override will begin and the screen will change to the override screen (see Figure 27).

The override will last for 5 minutes or until the **Fan Overrides** parameter is set to **No** again.

FIGURE 27
Enabling Fan Override

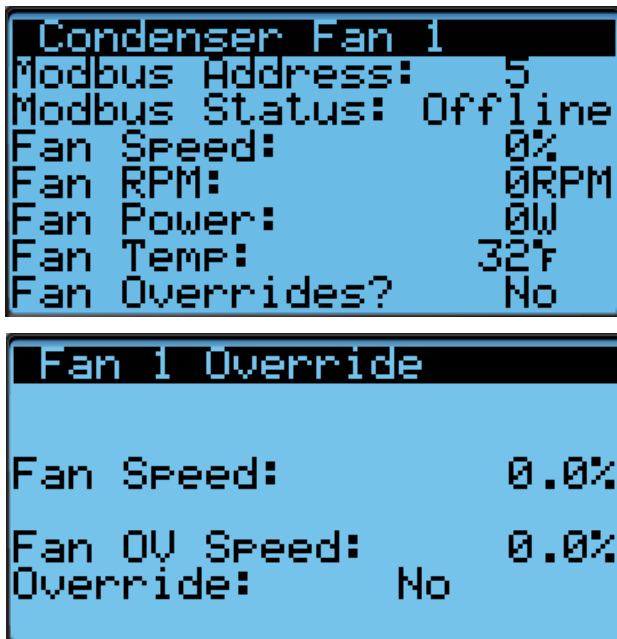

Liquid Pressure Sensor

The unit has a pressure transducer installed on the liquid line between the condenser and electronic expansion valve (EEV). The transducer is used for condenser fan speed control and for monitoring of system operation. The liquid line transducer is also referred to as the discharge or liquid pressure sensor.

The discharge/liquid pressure sensor input can be verified and adjusted by:

1. Press MENU key to go to the Main Menu screen.
2. Press UP or DOWN keys and ENTER key to enter TECHNICIAN password 1313.
3. Press UP or DOWN keys to scroll to **I/O Config**; press ENTER key.
4. Press UP or DOWN keys to scroll to **Analog Inputs**; press ENTER key.
5. Press UP or DOWN keys to scroll to **Analog Ins 7/19** (for circuit 1) or **Analog Ins 9/19** (for circuit 2).
6. Verify the measurement displayed on screen is accurate (see Figure 28).
7. If the measurement needs to be adjusted, apply an offset value by pressing the ENTER key to scroll to **Offset**.
8. Press UP or DOWN keys to adjust the offset. The update will not take effect until the cursor is moved out of the offset parameter.
9. Once adjusted, the ESCAPE key several times to return to Main Menu screen.

FIGURE 28
Adjusting Discharge/Liquid Transducer
Pressure Values

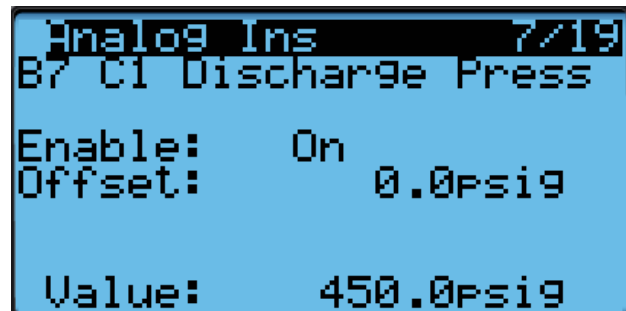

Troubleshooting the Discharge/Liquid Pressure Transducer

0-650 psig
 .5 to 4.5v
 $4.5 - .5 + 4 \text{ volt range} / 650 \text{ psig} = .00615 \text{ volts per 1 psig}$

Example: $325 \text{ psig} \times .00615 + .5 \text{ v} = 2.5 \text{ volts}$

Formula for Tech:

Measured Pressure x .00615 + Voltage Offset =
 Expected Transducer Signal Voltage (see Figure 29).

FIGURE 29
Voltage to Pressure:
Discharge/Liquid Pressure Transducer

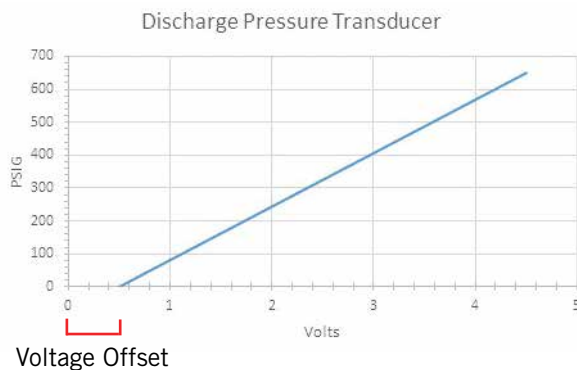

Discharge/Liquid Pressure Transducer Alarm

When the discharge pressure sensor value is out of range (0-650 PSIG), the controller will generate a sensor failure alarm to indicate the sensor is not working properly.

This alarm is fixed and cannot be adjusted.

Liquid Temperature Sensor

The unit is equipped with a liquid line temperature sensor to monitor the temperature of the liquid refrigerant leaving the condenser and entering the EEV. The temperature is measured with a 10k ohm NTC thermistor.

The liquid temperature sensor can be verified and adjusted by:

1. Press MENU key to go to the Main Menu screen.
2. Press UP or DOWN keys and ENTER key to enter TECHNICIAN password 1313.
3. Press UP or DOWN keys to scroll to **I/O Config**; press ENTER key.
4. Press UP or DOWN keys to scroll to **Analog Inputs**; press ENTER key.
5. Press UP or DOWN keys to scroll to **Analog Ins 16/19** (for circuit 1) or **Analog Ins 17/19** (for circuit 2).

6. Reference the **Value** to verify the temperature (see Figure 30).
7. If an offset needs to be applied, press ENTER key to scroll to **Offset**.
8. Press UP or DOWN keys to change the offset to desired value.
9. Press ENTER key to save.
10. Press ESCAPE key several times to return to Main Menu screen.

FIGURE 30
Adjusting Discharge/Liquid Temperature Input

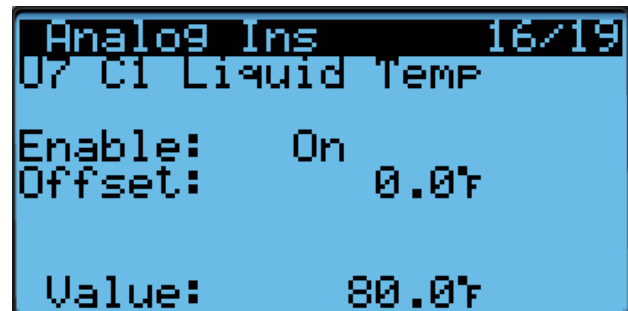

Outdoor Temperature Sensor

The unit is equipped with a combination outdoor temperature and humidity sensor. The temperature is measured with a 10k ohm NTC thermistor. See page 27 for more information.

Condenser Fan Operation

Condenser Fan Speed Control

The fan will speed up or slow down to attempt to maintain a discharge pressure setpoint. Because the control is dependent on the discharge pressure sensor, the controller will alter its operation if the sensor is not enabled or failed. When the liquid pressure transducer is not enabled or considered failed by the controller, a nominal speed will be used during a compressor call (see Table 8).

TABLE 8
Condenser Fan Nominal Speed

Unit	Discharge Pressure Setpoint	Nominal Speed
W090A	390 psig	60%
W120A	420 psig	74%

Compressor

Compressor Components

Compressor

Three Phase Scroll Compressor Start Up Information

Scroll compressors, like several other types of compressors, will only compress in one rotational direction. Direction of rotation is not an issue with single phase compressors since they will always start and run in the proper direction.

However, three phase compressors will rotate in either direction depending upon phasing of the power. Since there is a 50-50 chance of connecting power in such a way as to cause rotation in the reverse direction, verification of proper rotation must be made. Verification of proper rotation direction is made by observing that suction pressure drops and discharge pressure rises when the compressor is energized. Reverse rotation also results in an elevated sound level over that with correct rotation, as well as substantially reduced current draw compared to tabulated values.

Verification of **proper rotation** must be made at the time the equipment is put into service. If improper rotation is corrected at this time, there will be no negative impact on the durability of the compressor. However, reverse operation for over 1 hour may have a negative impact on the bearing due to oil pump out.

NOTE: *If compressor is allowed to run in reverse rotation for an extended period of time, the compressor's internal protector will trip.*

All three phase compressors are wired identically internally. As a result, once the correct phasing is determined for a specific system or installation, connecting properly phased power leads to the same Fusite terminal should maintain proper rotation direction.

The direction of rotation of the compressor may be changed by reversing any two line connections to the wall-mount unit.

Compressor Control Module (CCM)

Delay-on-Make Timer

Short Cycle Protection/Delay-on-Break

Test Mode

High Pressure Detection

Brownout Protection with Adjustment

The LPC terminals are jumpered in this application. Instead, the low pressure transducer is used for low pressure monitoring.

Each compressor uses an independent CCM.

Delay-on-Make Timer

In the event of power loss, a delay-on-make timer is included to be able to delay startup of the compressor. This is desired when more than one unit is on a structure so that all of the units do not start at the same time which could happen after a power loss or

building shutdown. The delay-on-make time period is 2 minutes plus 10% of the delay-on-break time period. To ensure that all of the units do not start at the same time, adjust the delay-on-break timer on each unit to a slightly different delay time.

Short Cycle Protection/Delay-on-Break

An anti-short cycle timer is included to prevent short cycling the compressor. This is adjustable from 30 seconds to 5 minutes via the adjustment knob (see Figure 31). Once a compressor call is lost, the time period must expire before a new call will be initiated.

10% of this time is also considered on the delay-on-make timer (see **Delay-on-Make Timer**).

High Pressure Detection

High pressure switch monitoring allows for a lockout condition in a situation where the switch is open. If the high pressure switch opens, the CCM will de-energize the compressor. If the switch closes, it will then restart the compressor after the delay-on-break setting has expired on the device. If the switch trips again during the same Y call, the compressor will be de-energized. The ALR terminal will be energized, signaling the unit control board that a high pressure event has occurred (see **Refrigerant High Pressure Alarm** on page 23).

Test Mode

By rapidly rotating the potentiometer (POT) clockwise (see Figure 31), all timing functions will be removed for testing.

The conditions needed for the unit to enter test mode are as follows: POT must start at a time less than or equal to the 40 second mark. The POT must then be rapidly rotated to a position greater than or equal to the 280 second mark in less than ¼ second. Normal operation will resume after power is reset or after the unit has been in test mode for at least 5 minutes.

Brownout Protection with Adjustment

Brownout protection may be necessary if the utility power or generator power has inadequate power to prevent the voltage from dropping when the compressor starts. This is rare but can happen if the generator is undersized at the site or if the site is in a remote location far from the main power grid. Under normal circumstances, allowing the brownout to be ignored for a time period should not be needed. The 8201-164 is shipped with all the DIP switches in the 'off' or 'do not ignore' position (see Figure 31).

If ignoring the brownout is needed because of the above conditions, three preset timers can be set by DIP switches in order to delay signaling a power brownout for a specific length of time after compressor contactor is energized. This allows the compressor a time period to start even if the voltage has dropped and allows the voltage to recover. This delay only happens when the CC terminal energizes. The delay can be set to 500 milliseconds (A DIP switch), 1000 milliseconds (B DIP

switch) or 1500 milliseconds (C DIP switch); time is not cumulative—only the longest setting will apply. If the voltage recovers during the brownout time period, the compressor will start.

If a brownout condition is detected by the 8201-164, the troubleshooting light will flash blue. The light will continue to flash until the cooling call is satisfied or power is removed from the Y terminal. This condition does not prevent operation, it only indicates that a brownout condition was present at some point during the cooling call. If a brownout condition is detected, CC will be de-energized and will retry after the delay-on-make timer is satisfied; this process will continue until call is satisfied.

If user chooses the 'do not ignore' position when the site has inadequate utility or generator power, this could lead to the compressor never starting. The control will see the brownout immediately and not start.

A common scenario and one that has been seen in the field is when a unit or units switches from utility power to generator power. With slower transfer switches, the time delay between the utility power and generator

power didn't cause a problem. The units lost power, shut off and came back on line normally. With the introduction of almost instantaneous transfer switches, the millisecond long power glitch can be enough that the compressor will start to run backwards. In this scenario, the CCM will catch this and restart the units normally.

High Pressure Safety Switch

All units have a high pressure switch as a safety device. This device will open when pressure in the system reaches 650 PSIG. The switch is directly connected to the dedicated compressor control module (see **High Pressure Detection** on page 22).

Refrigerant High Pressure Alarm

When the wall-mount unit receives a signal from the compressor control module (CCM) indicating a high pressure event, the wall-mount unit will generate an alarm. Upon receiving the alarm, the wall-mount unit will remove the “Y” call from the CCM, resetting the status of the CCM. The alarm will stay present on the wall-mount unit until manually cleared with TEC-EYE hand-held diagnostic tool.

FIGURE 31
8201-164 Compressor Control Module

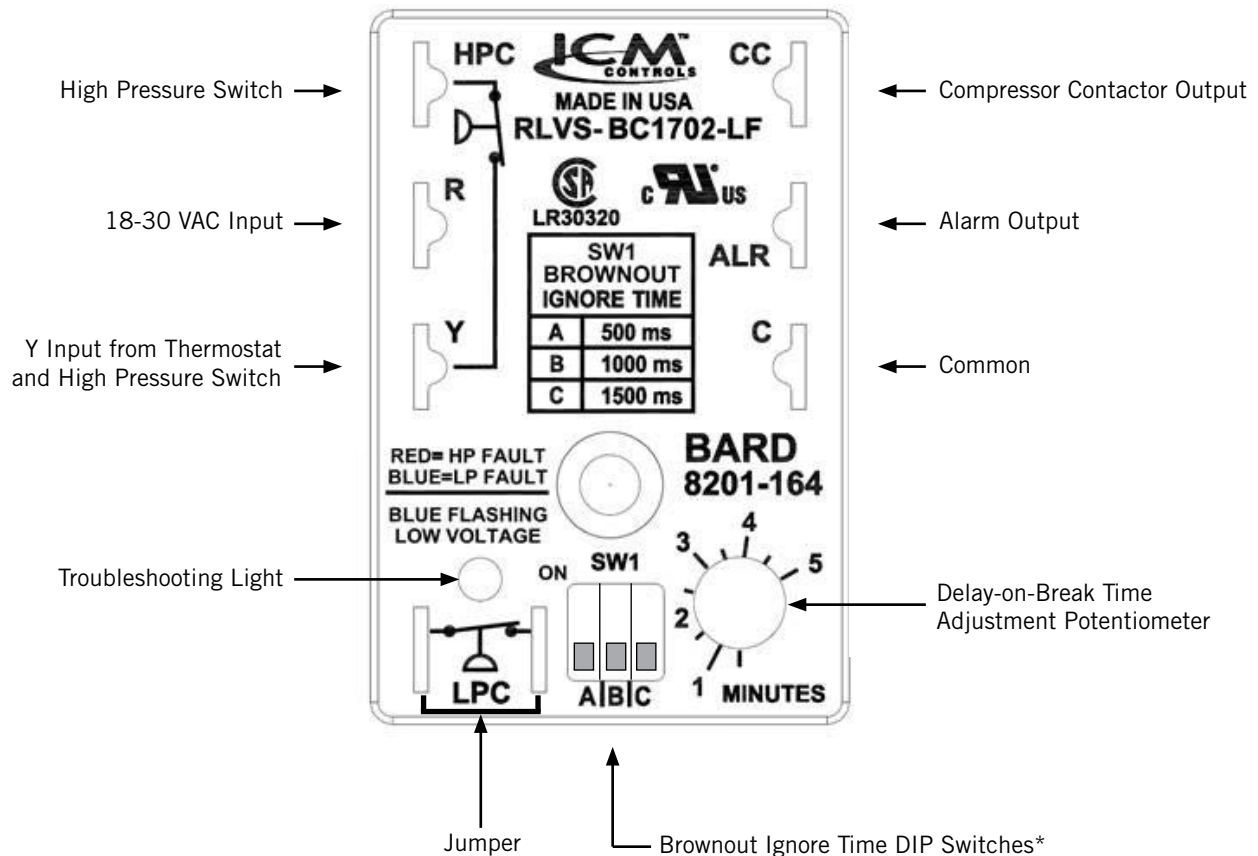

* Turn on only one switch for that specific ignore time setting. 1500 milliseconds is the maximum brownout ignore time.

In addition to the CCM, the discharge pressure transducer is used to prevent a high pressure event. When the discharge pressure is above the discharge pressure alarm setpoint (set 30 pounds below high pressure switch, which is 650), the system will disable stage 2 of mechanical cooling.

Phase Monitor

Used only on three phase equipment, the phase monitor is a compressor protection device that will prohibit operation of the compressor if the device senses a possible reverse-rotation situation due to incorrect phasing. On a call for compressor (and only compressor), the device will check incoming phase, check for severe voltage imbalance and check for proper frequency. Under nominal conditions, a green LED light will show on the face of the monitor. If there is improper phasing, voltage imbalance or frequency deviation, the device will show a red LED light and prohibit compressor operation.

If a fault condition occurs, reverse two of the supply leads to the unit. **Do not reverse any of the unit factory wires as damage may occur.**

Compressor Operation

The compressor will be enabled when the unit (in orphan mode) or LC provide a cooling stage 1 call. The compressor call from the controller has several delays that may affect the start or stop time of the compressor in regards to the cooling demand. The compressor has a minimum on time of 180 seconds to prevent short cycling the compressor. The compressor also has a minimum off time of 120 seconds to prevent start ups before the pressure in the refrigeration system equalizes. When the second stage is engaged, it also has a minimum run time of 120 seconds to allow the system to stabilize before returning to single stage or shutting down.

These delays can be changed by:

1. Press MENU key to go to the Main Menu screen.
2. Press UP or DOWN keys and ENTER key to enter TECHNICIAN password 1313.
3. Press UP or DOWN keys to scroll to **Adv System Config**; press ENTER key.
4. Press UP or DOWN keys to scroll to **Comp. Safety B2**; press ENTER key.
5. Press ENTER key to scroll to **Min On Time** or **Min Off Time** (see Figure 32).
6. Press UP or DOWN keys to change the value.
7. Press ENTER key to save value and move the cursor to next parameter or top of screen.
8. Press ESCAPE key several times to return to Main Menu screen.

The address-based delay only applies to the wall-mount unit when in orphan mode. The controller will delay the unit compressor based on the value entered on screen B2 multiplied by the unit address. This is intended to keep multiple units from starting their compressors at the same time when there is a quick change in the load. When connected to the LC, this is taken care of by LC logic.

FIGURE 32
Adjusting Compressor Delays



Additional Compressor Alarms

Refrigerant Low Pressure Alarm

When the suction pressure transducer indicates a pressure value less than the low pressure alarm setpoint of 40 PSIG and there is an active call for cooling, the controller will disable the compressor (after a 120-second delay). **NOTE:** The second call will be delayed based on the delay off value mentioned in the compressor section. The controller will try to run the refrigeration system two (2) times within 900 seconds before the alarm will lock the compressor out. This alarm needs to be manually cleared before compressor operation will resume.

Economizer

Economizer Components

Actuator

The actuator rotates up to 90° based on a 2-10v signal sent to it by the controller. This component is what opens and closes the damper blade. The unit is equipped with three dampers powered by three separate actuators. The left intake damper (damper 1) and the right intake damper (damper 3) are each powered by a 44 in-lb actuator. The exhaust damper (damper 2) is powered by a 90 in-lb actuator. All dampers are spring return and will close the damper if power is lost.

To verify the output from the controller to the actuator:

1. Press MENU key to go to the Main Menu screen.
2. Press UP or DOWN keys and ENTER key to enter TECHNICIAN password 1313.
3. Press UP or DOWN keys to scroll to **Analog Outputs**; press ENTER key.

4. Press UP or DOWN keys to scroll to **Damper System 1/5**.
5. To override the current position, press ENTER key to scroll to **System OV Pos** (see Figure 33).
6. Press UP or DOWN keys to change the value to the desired output.
7. Press ENTER key to save the value and move cursor to **Enable Sys. OV**.
8. Press UP or DOWN keys to change the value from **No** to **Yes**.
9. The damper position will update with the new override value and the damper will travel to that position.

NOTE: This override will last for 5 minutes or until the **Enable Sys. OV** is changed back to **No**.

FIGURE 33
Damper Override

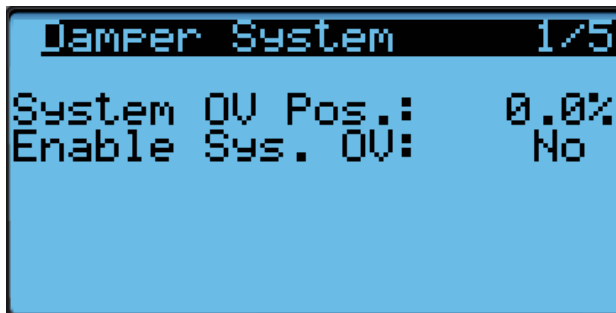

Dust Sensor

The unit has a dust sensor installed near the outdoor air inlet. The dust sensor checks for excessive particulates in the outdoor air, and will close the economizer if the dust is excessive. The sensor uses a PWM signal converted to 0-5v output to the controller.

To ensure proper performance, cleaning may be required. Vacuuming or blowing the dust off the sensor with forced air is recommended. **Avoid inserting any objects into the sensor.**

The dust sensor can be verified by:

1. Press MENU key to go to the Main Menu screen.
2. Press UP or DOWN keys and ENTER key to enter TECHNICIAN password 1313.
3. Press UP or DOWN keys to scroll to **I/O Config**; press ENTER key.
4. Press UP or DOWN keys to scroll to **Analog Inputs**; press ENTER key.
5. Press UP or DOWN keys to scroll to **Analog Ins 15/19**.
6. Reference the **Value** for the current sensor reading (see Figure 34).

7. To apply an offset to the current reading, press ENTER key to scroll to **Offset**.
8. Press UP or DOWN keys to adjust the value to the desired value.
9. Press ENTER key to save the value and move cursor to next parameter.

NOTE: The sensor can be disabled if required for troubleshooting.

10. With the cursor on the **Enable** parameter, press UP or DOWN keys to change the value from **On** to **Off**.
11. Press ENTER key to save.

FIGURE 34
Dust Sensor

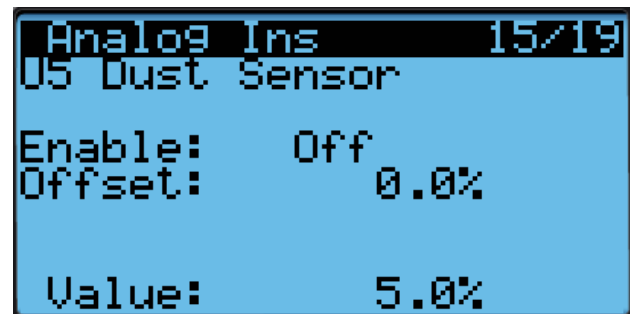

Dust Sensor Failure Alarm

When the sensor reads a value that is outside of the acceptable 0 to 100% range, an alarm will be generated indicating the sensor has failed. This alarm is just a notification and will not disable any other features on the controller.

This alarm is fixed and cannot be adjusted.

High Dust Limit Alarm

When dust content in the air is high and is a risk to prematurely reducing airflow through the filters, the unit will restrict the use of the economizer. The controller has adjustable software setpoints to indicate dust levels are too high and to disable the economizer operation for 5 minutes. Once the conditions are no longer present, the alarm will automatically clear.

To adjust the dust sensor alarm setpoint:

1. Press MENU key to go to the Main Menu screen.
2. Press UP or DOWN keys and ENTER key to enter USER password 2000.
3. Press UP or DOWN keys to scroll to **System Config**; press ENTER key.
4. Press UP or DOWN keys to scroll to **Dust Configuration A4**.
5. Press ENTER key to scroll to **Alarm Set** (see Figure 35 on page 26).
6. Press UP or DOWN keys to change to the desired value.

7. Press ENTER key to save the value.

NOTE: When the temperature outside is measured at or below 0°F, the dust sensor alarm will be disabled to allow economizer operation.

FIGURE 35
Adjusting Dust Sensor Alarm Setpoint

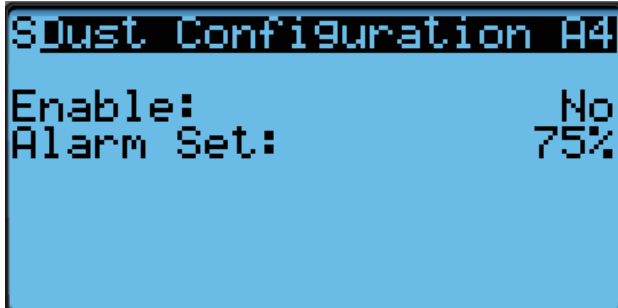

Damper Blade

The system utilizes three damper blades to bring in outdoor air and exhaust space air for economizer operation. Damper 1 is left intake, damper 2 is exhaust and damper 3 is right intake. Damper blades are made of sheet metal and are integrated into the equipment.

To view damper blade position:

1. Press MENU key to go to the Main Menu screen.
2. Press UP or DOWN keys and ENTER key to enter TECHNICIAN password 1313.
3. Press UP or DOWN keys to scroll to **I/O Config**; press ENTER key.
4. Press UP or DOWN keys to scroll to **Analog Outputs**; press ENTER key.
5. Press UP or DOWN keys to scroll to **Damper Intake Lt 2/5** (see Figure 36), **Damper Intake Rt 3/5** or **Damper Exhaust 1**.

FIGURE 36
Damper Blade Position

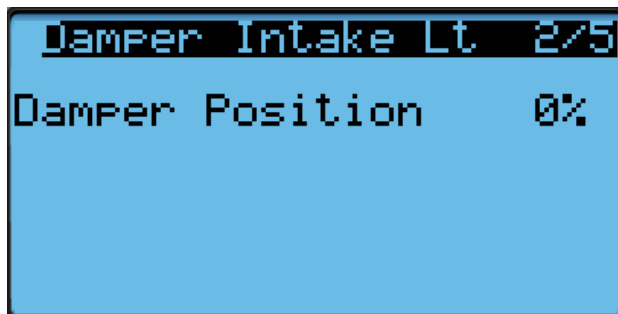

Damper Switch

The economizer utilizes three magnetic switches (one on each damper blade) to determine if the damper is operating correctly. This switch will be closed when the damper is closed and open when the damper is open.

To verify the status of the switch:

1. Press MENU key to go to the Main Menu screen.
2. Press UP or DOWN keys and ENTER key to enter TECHNICIAN password 1313.
3. Press UP or DOWN keys to scroll to **I/O Config**; press ENTER key.
4. Press UP or DOWN keys to scroll to **Digital Inputs**; press ENTER key.
5. Press UP or DOWN keys to scroll to **Digital Ins 2/2**.
6. Reference the values for **Damper 1**, **Damper 2**, **Damper 3** and **Damper 4** (see Figure 37).
7. The input will display **ON** when the damper is closed (reflecting closed circuit on damper switch) and will display **OFF** when the damper is open (reflecting open circuit on damper switch).

FIGURE 37
Damper Switch

Digital Ins				2/2
Channel	En	Dir	Val	
Filter 2	Yes	N/O	Off	
Panel Sw	Yes	N/O	Off	
Damper 1	Yes	N/O	On	
Damper 2	Yes	N/O	On	
Damper 3	Yes	N/O	On	
Damper 4	Yes	N/O	On	

Damper Failed to Open Alarm

When the controller commands the economizer damper actuator to a position other than 0% and the damper switch indicates the damper is not open, after a delay of 20 seconds the controller will generate a damper failed to open alarm. This alarm is just a notification and will not disable any features on the controller.

The alarm must be cleared by a user reset.

Damper Failed to Close Alarm

When the controller commands the economizer damper actuator to the 0% position and the damper switch indicates the damper is not closed, after a delay of 300 seconds the controller will generate a damper failed to close alarm. This alarm is just a notification and will not disable any features on the controller.

The alarm must be cleared by a user reset.

Outdoor Temperature and Humidity Combination Sensor

The unit is equipped with a combination outdoor temperature and humidity sensor to monitor outdoor conditions for the economizer operation. The temperature is measured with a 10k ohm NTC thermistor. The humidity is measured with a humidity sensor that outputs a 4-20mA signal to the controller.

The outdoor temperature can be verified by:

1. Press MENU key to go to the Main Menu screen.
2. Press UP or DOWN keys and ENTER key to enter TECHNICIAN password 1313.
3. Press UP or DOWN keys to scroll to **I/O Config**; press ENTER key.
4. Press UP or DOWN keys to scroll to **Analog Inputs**; press ENTER key.
5. Press UP or DOWN keys to scroll to **Analog Ins 4/19**.
6. Reference the **Value** to see the input of the sensor (see Figure 38).
7. To apply an offset, press ENTER key to scroll to **Offset**.
8. Press UP or DOWN keys to change to the desired value.
9. Press ENTER key to save the value.

FIGURE 38
Outdoor Temperature Sensor

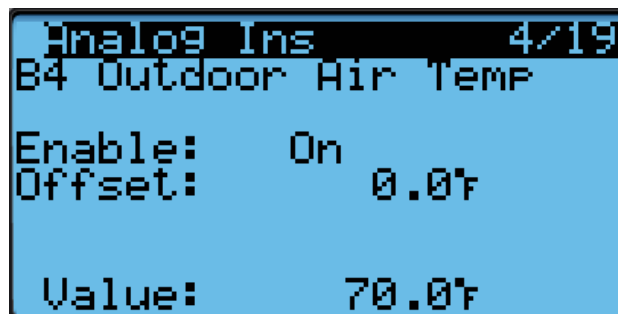

The outdoor humidity can be verified by:

1. Press MENU key to go to the Main Menu screen.
2. Press UP or DOWN keys and ENTER key to enter TECHNICIAN password 1313.
3. Press UP or DOWN keys to scroll to **I/O Config**; press ENTER key.
4. Press UP or DOWN keys to scroll to **Analog Inputs**; press ENTER key.
5. Press UP or DOWN keys to scroll to **Analog Ins 5/19**.
6. Reference the **Value** to see the input of the sensor (see Figure 39).

7. To apply an offset, press ENTER key to scroll to **Offset**.
8. Press UP or DOWN keys to change to the desired value.
9. Press ENTER key to save the value.

FIGURE 39
Outdoor Humidity Sensor

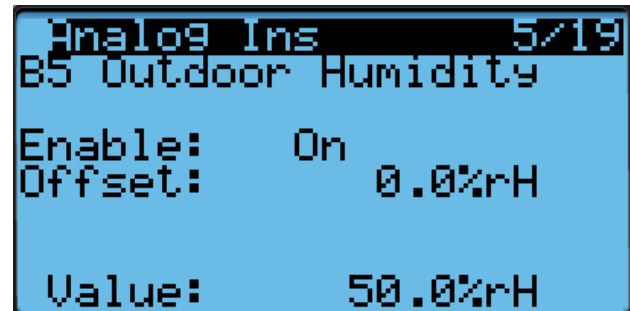

Outdoor Temperature Sensor Failure Alarm

When the sensor reads a value that is outside of the acceptable -41 to 303.0° range, an alarm will be generated indicating the sensor has failed. This alarm condition will disable the economizer.

This alarm is fixed and cannot be adjusted.

Outdoor Humidity Sensor Failure Alarm

When the sensor reads a value that is outside of the acceptable 0 to 100% RH range, an alarm will be generated indicating the sensor has failed. This alarm condition will disable the economizer when the mode is set to temperature and humidity or enthalpy.

This alarm is fixed and cannot be adjusted.

Mixed Air Temperature Sensor

The unit is equipped with a mixed air temperature sensor to monitor the mixed air temperature. The mixed air is measured where the economizer mixes return air and outdoor air. This measurement is used to determine if the economizer is controlling correctly. The sensor is a 10k ohm NTC Thermistor.

The mixed air temperature can be verified by:

1. Press MENU key to go to the Main Menu screen.
2. Press UP or DOWN keys and ENTER key to enter TECHNICIAN password 1313.
3. Press UP or DOWN keys to scroll to **I/O Config**; press ENTER key.
4. Press UP or DOWN keys to scroll to **Analog Inputs**; press ENTER key.
5. Press UP or DOWN keys to scroll to **Analog Ins 18/19**.
6. Reference the **Value** to see the input of the sensor (see Figure 40 on page 28).

7. To apply an offset, press ENTER key to scroll to **Offset**.
8. Press UP or DOWN keys to change to the desired value.
9. Press ENTER key to save the value.

FIGURE 40
Mixed Air Temperature Sensor

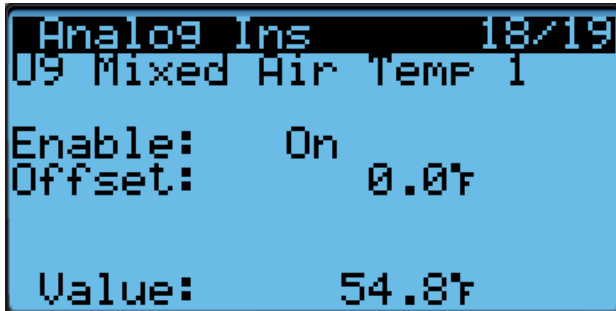

High Mixed Air Temperature Alarm

To keep the economizer from bringing in air that is too warm, an alarm will be generated when the mixed air is 2° above the return air temperature for 300 seconds. This alarm will not be generated if the mixed air temperature sensor has failed. The alarm can only be activated during a free cooling call. The alarm is a user reset and must be cleared by the end user.

Low Mixed Air Temperature Alarm

To keep the economizer from bringing in air that is too cold, an alarm will be generated when the mixed air temperature is 5°F below the mixed air temperature control setpoint for 300 seconds. If this alarm is active, the economizer will be disabled for the current cooling call. This alarm will reference the mixed air temperature control setpoint to ensure that when the mixed air setpoint changes, the alarm dynamically changes with it. This alarm will not be generated if the mixed air temperature sensor has failed. The alarm can only be activated during a free cooling call and requires a user reset.

Economizer Operation

See Figure 57 on page 49 for ventilation airflow paths.

The economizer has four types of operation. The first mode is "None" where the economizer is never utilized, except for emergency purposes. The second mode is "Dry Bulb" where the outdoor temperature is the only consideration for economizer use on a free cooling call. The third mode is "TempHum" where the outdoor temperature and humidity are considered for economizer use on a free cooling call. The fourth mode is "Enthalpy" where the outdoor temperature, humidity and calculated dew point are considered for economizer operation on a free cooling call.

To change the economizer type:

1. Press MENU key to go to the Main Menu screen.
2. Press UP or DOWN keys and ENTER key to enter USER password 2000.
3. Press UP or DOWN keys to scroll to **System Config**; press ENTER key.
4. Press UP or DOWN keys to scroll to **Economizer Setup A2**; press ENTER key.
5. Press ENTER key to scroll to **Type** (see Figure 41).
6. Press UP or DOWN keys to change the **Type** desired value to **None**, **Dry Bulb**, **TempHum** or **Enthalpy**.
7. Press ENTER key to save the value and scroll to the next parameter.

FIGURE 41
Economizer Setup



NOTE: The following parameters are for the temperature consideration for economizer use. Applies to **Dry Bulb**, **TempHum** and **Enthalpy** type.

8. The cursor should now be on the **Mixed Air Temp** parameter.
9. Press UP or DOWN keys to change the parameter to the desired value.
10. Press ENTER key to save the value and scroll to the next parameter.
11. The cursor should now be on **Delay** parameter.
12. Press UP or DOWN keys to change the parameter to the desired value.
13. Press ENTER key to save the value and move to the next parameter.
14. The cursor is now on the **Min Position** parameter.
15. Press UP or DOWN keys to change the parameter to the desired value (see **Economizer Operation – Minimum Position** on page 29 for more information).
16. Press ENTER key to save the value.
17. Press the DOWN key to navigate to the **A3** screen.

NOTE: The **A3** screen will not display if economizer mode is set to **None**. Also, the contents of the

screen will change depending on which type is chosen: **Dry Bulb** (Figure 42), **TempHum** (Figure 43) or **Enthalpy** (Figure 44). The following menu shows the **Enthalpy** content which also contains parameters that would be shown on **Dry Bulb** (temperature only) and **TempHum** (temperature and humidity only).

18. Press ENTER key to scroll to **OA Temp Set** (on **Drybulb Control** and **Temp/Hum Control A3** screens, this parameter will be titled **Outdoor Set**).
19. Press UP or DOWN keys to change the temperature setpoint to desired value.
20. Press ENTER key to save the value and scroll to **Off Diff**.
21. Press UP or DOWN keys to adjust the outdoor temperature differential for which the economizer is re-enabled.
22. Press ENTER key to save the value and scroll to **OA Hum Set**.
23. Press UP or DOWN keys to adjust the humidity setpoint to desired value.
24. Press ENTER key to save the value and scroll to **On Diff**.
25. Press UP or DOWN keys to adjust the outdoor humidity differential for which the economizer is re-enabled.
26. Press ENTER key to save the value and scroll to **Dew Pt. Set**.
27. Press UP or DOWN keys to adjust the outdoor dew point setpoint for economizer operation to the desired value.
28. Press ENTER key to save the value and scroll to **On Diff**.
29. Press UP or DOWN keys to adjust the dew point differential for which the economizer is re-enabled.
30. Press ENTER key to save the value.
31. Press ESCAPE key several times to return to Main Menu screen.

See Table 9 for default settings for economizer operation.

FIGURE 42
Economizer Setup – Dry Bulb Control

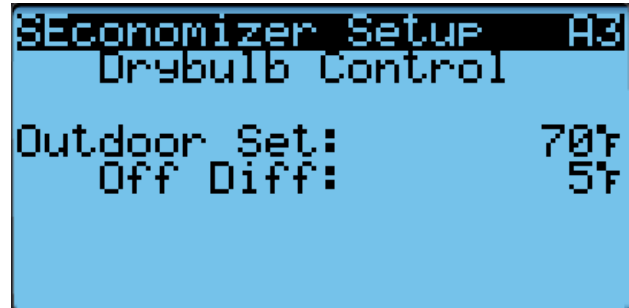

FIGURE 43
Economizer Setup – Temp/Hum Control

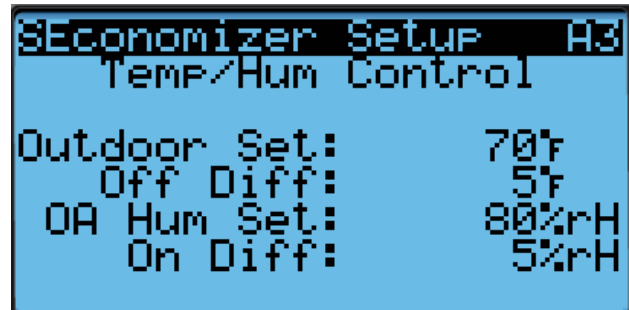

FIGURE 44
Economizer Setup – Enthalpy Control

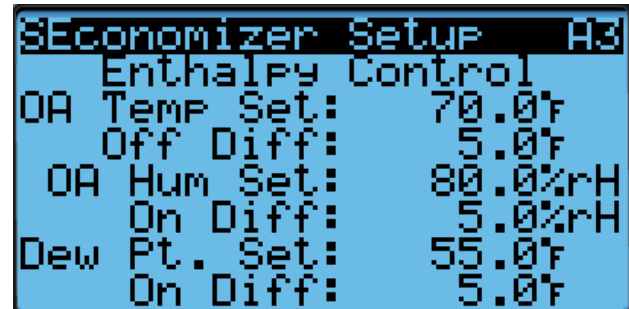

TABLE 9
Economizer Default Settings

Mode			Consideration	Economizer Available for Cooling	Economizer Not Available for Cooling
Temp Only	Temp & Humidity	Enthalpy*	Temperature	When the outdoor air temperature is below 70°F	When the outdoor air temperature is above 75°F
			Humidity	When the outdoor humidity is below 80%	When the outdoor humidity is above 80%
			Dew Point	When the outdoor dew point is below 55°F	When the outdoor dew point is above 60°F

* In Enthalpy mode, outdoor temperature, humidity and calculated dew point are all considered for economizer operation.

When the economizer is activated during a free cooling call only, using any of the previously mentioned modes, a 0-10v analog signal will be sent to the economizer actuator. The actuator will then open and close the damper blades to maintain a mixed air temperature of 55°F. When the mixed air temperature increases, the damper will open and when the mixed air temperature decreases, the damper will close.

The economizer may be disabled by the LC if the system determines it needs to enter dehumidification mode. More information about the dehumidification sequence can be found in the latest revision of LC6000 Service Instructions 2100-669. In addition to dehumidification mode, the economizer may be disabled for 5 minutes (adjustable) if the dust sensor indicates the outdoor air may cause particulate buildup in the air filters. After the time has expired and on a call for cooling, the economizer will open again to sample the air. The wall-mount unit will either return to normal operation or remain locked out for another 5 minutes.

Economizer Operation – Minimum Position

The economizer has an option to set minimum position for the economizer. The minimum position will only be active while the blower is operating. To enable minimum position all the time, continuous blower must be activated for the wall unit in the LC6000. See latest version of LC6000 Service Instructions 2100-669 for continuous blower configuration.

To set the minimum position value:

1. Press MENU key to go to the Main Menu screen.
2. Press UP or DOWN keys and ENTER key to enter USER password 2000.
3. Press UP or DOWN keys to scroll to **System Config**; press ENTER key.
4. Press UP or DOWN keys to scroll to **Economizer Setup A2**.
5. Press ENTER key to scroll to **Min Position** (see Figure 41 on page 28).
6. Press UP or DOWN keys to change to the desired value.

Miscellaneous Components

Supply Temperature Sensor

The unit is equipped with a supply air temperature sensor to monitor the leaving air temperature of the unit. The temperature is measured with a 10k ohm NTC thermistor.

The supply air temperature can be verified by:

1. Press MENU key to go to the Main Menu screen.
2. Press UP or DOWN keys and ENTER key to enter TECHNICIAN password 1313.
3. Press UP or DOWN keys to scroll to **I/O Config**; press ENTER key.

4. Press UP or DOWN keys to scroll to **Analog Inputs**; press ENTER key.
5. Press UP or DOWN keys to scroll to **Analog Ins 2/19**.
6. Reference the **Value** to see the input of the sensor (see Figure 45).
7. To apply an offset, press ENTER key to scroll to **Offset**.
8. Press UP or DOWN keys to change to the desired value.
9. Press ENTER key to save the value.

FIGURE 45
Supply Air Temperature Sensor

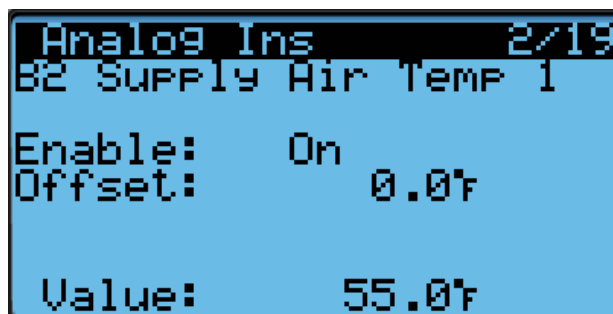

Supply Temperature Sensor Failure Alarm

When the sensor reads a value that is outside of the acceptable -41.0 to 303.0° range, an alarm will be generated indicating the sensor has failed.

This alarm is fixed and cannot be adjusted.

Emergency Cooling Mode

If the shelter temperature is above the high temperature alarm setpoint on the LC, the unit will be commanded into emergency cooling mode. In this mode, the unit will operate the economizer regardless of the economizer setup, as long as the outdoor temperature is below the indoor temperature. This will stay active until the LC returns the unit to normal operation.

Emergency Cooling – Orphan Mode

When the unit is not connected to the LC6000 and operating in orphan mode, the unit still has the capability to operate in emergency cooling mode. By default this feature is not enabled.

To enable emergency cooling in orphan mode:

1. Press MENU key to go to the Main Menu screen.
2. Press UP or DOWN keys and ENTER key to enter TECHNICIAN password 1313.
3. Press UP or DOWN keys to scroll to **Adv System Config**; press ENTER key.
4. Press UP or DOWN keys to scroll to **Emer. Cool B5**.

5. Press ENTER key to scroll to **Use emergency cool in Orphan Mode?** (see Figure 46).
6. Press UP or DOWN keys to change the value.

FIGURE 46
Emergency Cool – Orphan Mode

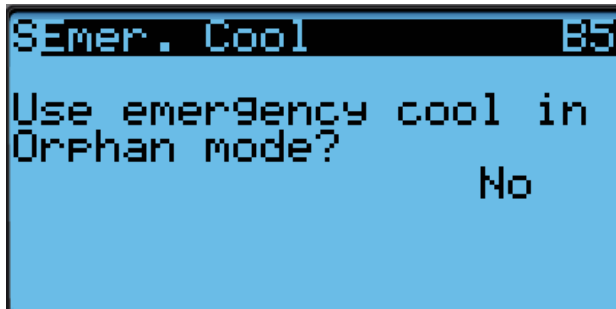

When this feature is used instead of using the zone sensor, an alarm will be triggered by the high return air temperature alarm.

To adjust the return air temperature settings:

1. Press MENU key to go to the Main Menu screen.
2. Press UP or DOWN keys and ENTER key to enter USER password 2000.
3. Press UP or DOWN keys to scroll to **System Config**; press ENTER key.
4. Press UP or DOWN keys to scroll to **Return Air Alarm A5**.
5. Press ENTER key to scroll to **Enable, Lower Limit** or **Upper Limit** (see Figure 47).
6. Press UP or DOWN keys to disable the alarm or change the limit values.

FIGURE 47
Adjusting Return Air Alarm Settings

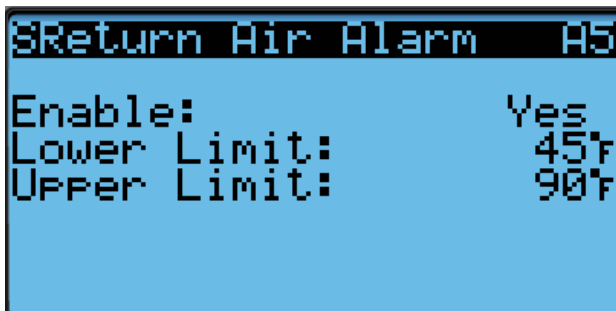

Emergency Ventilation Mode

If the emergency ventilation input at the LC is active, the system will go into emergency ventilation mode. In emergency ventilation mode, the economizers on the wall units will be commanded to 100%. This mode is only available when connected to the LC.

NOTE: All units will receive the emergency ventilation command. Wall units not equipped with economizers will still engage the blower.

Electric Heat Option

Electric Heat Components

Electric Heating Element

The unit can be optionally equipped with 9kw or 18kw of heat. The 9kw is a single stage heating element. The 18kw option comes equipped with two 9kw heating elements that operate in two stages. The heating elements are located downstream of the evaporator coils and can be accessed through the upper control panel door.

Thermal Overload

The heater assembly has a thermal overload wired in series with the heating element. This device has a cycling limit which opens at 130°F and resets at 80°F. The limit is also equipped with a redundant thermal fuse that will open at 150°F.

Electric Heat Operation

The heat strip will be activated on a call for heat. This call can be generated by the LC or the wall-mount unit operating in orphan mode.

Electric Reheat Dehumidification

The MEGA-TEC wall-mount unit can be ordered with optional electric reheat dehumidification. This feature is indicated by the letter "E" in the 6th character of the model number. Electric reheat dehumidification is only available as a factory-installed option that must be ordered with the unit. It cannot be installed in the field on an existing unit.

To verify the dehumidification capability of a unit and/or disable the dehumidification operation:

1. Press MENU key to go to the Main Menu screen.
2. Press UP or DOWN keys and ENTER key to enter USER password 2000.
3. Press UP or DOWN keys to scroll to **System Config**; press ENTER key.
4. Press UP or DOWN keys to scroll to **Dehum Config A9** (see Figure 48 on page 32).

NOTE: Capability on this menu will show the unit's dehumidification capability based on the model number entered into the wall-mount unit's controller. This parameter will show either **Not Available** or **Electric Reheat**.

5. Press ENTER key to scroll to **Enable**.
6. Press UP or DOWN keys to change the value from **Yes** to **No**.

FIGURE 48
Electric Reheat Dehumidification

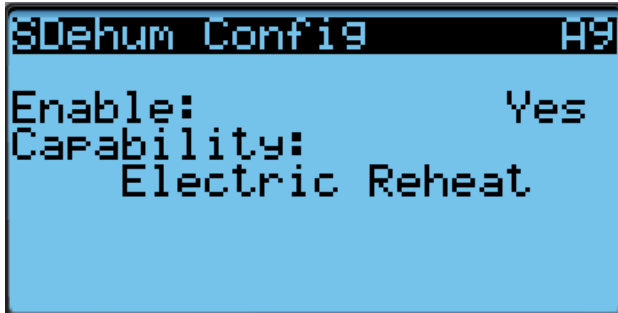

An electric reheat capable unit will allow for concurrent operation of compressor and electric heat. This allows the compressor to operate which will remove moisture from the indoor air while the electric heat keeps the space temperature from dropping during this operation. The cooling capacity of the MEGA TEC is much greater than its capacity to heat with either the 9kw or 18kw option. In order to extend the compressor run times and prevent the unit from overcooling the space, the cooling capacity will be limited during dehumidification operation (see Table 10).

TABLE 10
Cooling Capacity Limitation

Heat Option	Limitation	Heat Capacity*	Cooling Capacity*
9 Kw	Compressor 1 Part Load	30,709	39,600
18 Kw	Compressor 1 Full Load	61,418	60,000

* Capacities listed are nominal and don't reflect actual performance.

Electric Reheat Dehumidification Operation

The unit will utilize electric reheat dehumidification when it receives an active dehumidification call from the LC6000 supervisory controller. During the active dehumidification call, the unit status message will show "Active Dehum". An LC6000 equipped with and indoor humidity sensor is required to utilize dehumidification.

When the command is received from the LC6000, the wall unit will engage the compressor to begin removing moisture from the space and turn on the electric heat to extend the run time of the cooling cycle while mitigating the cooling done by the compressor. If/when the return temperature falls to 2° above heating setpoint, the compressor will be disabled until the temperature is increased to 2° below the cooling setpoint and then compressor will be re-energized (see Figure 49). If/when the temperature reaches 4° below the cooling setpoint, the electric heating elements will be energized. The electric heating elements will be disabled 2° below the cooling setpoint. The system will continue the dehumidification process until either the heating or cooling setpoint are reached again or the active dehumidification command from the LC6000 has been removed.

A heating or cooling call will disable the dehumidification call. Dehumidification can only take place when the system is not actively heating or cooling.

For more information on dehumidification staging, see latest version of LC6000 Service Instructions manual 2100-669.

FIGURE 49
Dehumidification Control (°F)

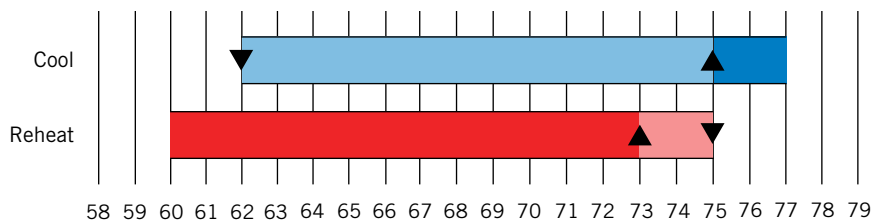

Unit Disable Option

The wall-mount unit can be disabled by opening a dry set of contacts connected to Input DI1 on the PLC board. This feature can be used in addition to the emergency off feature provided by the LC6000 to ensure that the unit does not operate even when in orphan mode. This feature is disabled by default and must be enabled before the input will affect unit operation. When the input detects open contacts, all unit operation will stop and the dampers will close. This is an automatic reset feature that will resume operation as soon as the unit detects the contacts are closed again.

For applications that require the dampers to close rapidly, an additional relay should be installed that either breaks the 24VAC power supply to each actuator or breaks the low voltage power supply to all units. In normal operation, the dampers can take up to 2 minutes to close from fully open. When the 24VAC power is removed from the actuator, the dampers will close in under 30 seconds using the spring return on the actuator.

NOTE: Alarm logging and trend logging will not be available if power is removed from the controller and unit offline alarms will be recorded on the LC6000.

The unit disable input can be verified and adjusted by:

1. Press MENU key to go to the Main Menu screen.
2. Press UP or DOWN keys and ENTER key to enter TECHNICIAN password 1313.
3. Press UP or DOWN keys to scroll to **I/O Config**; press ENTER key.
4. Press UP or DOWN keys to scroll to **Digital Inputs**; press ENTER key.
5. Press UP or DOWN keys to scroll to **Digital Ins 1/2**.
6. Reference **Disable** row and **En** column (see Figure 50).

FIGURE 50
Unit Disable Option

Digital Ins 1/2			
Channel	En	Dir	Val
Disable	No	N/C	Off
CCM1	Yes	N/O	Off
CCM2	Yes	N/O	Off
Airflw 1	Yes	N/O	Off
Airflw 2	No	N/O	Off
Filter 1	Yes	N/O	Off

7. Press ENTER key to scroll to **Disable En** value.
8. Press UP or DOWN key to change value.
9. Press ENTER key to scroll to **Dir**.
10. Press UP or DOWN key to change direction (**N/O** or **N/C**), if applicable.
11. Press ESCAPE key several times to return to Main Menu screen.

Serial/Model Number Configuration

MEGA-TEC wall-mount units configure some settings based on the model number that is input into the unit. The model and serial number are entered at the factory, and should be retained during a software update. However, after a software update, it is best practice to verify that the model and serial number is still present and accurate. If the model and/or serial number is missing or incorrect they will need to be re-entered.

To update serial/model numbers:

1. Press MENU key to go to the Main Menu screen.
2. Press UP or DOWN keys and ENTER key to enter ENGINEER password 9254.
3. Press UP or DOWN keys to scroll to **Adv. Sys. Config**; press ENTER key.
4. Press UP or DOWN keys to scroll to **Unit Setup B1** (see Figure 51).
5. Press ENTER key to advance the cursor to the digit that needs changed in the serial/model number.
6. Press UP or DOWN keys to change value of the digit.
7. Continue Steps 5 and 6 until the serial/model number(s) are correct and reflect the number on the product label.

For more information on the options and settings available for specific model numbers, see the model number breakdown in Figure 52 on page 34.

FIGURE 51
Serial/Model Number Configuration

Unit Setup B1	
Serial Number	0123456789
Model Number	W120APB18EM1X0X

FIGURE 52
MEGA-TEC Wall-Mount Unit Model Nomenclature

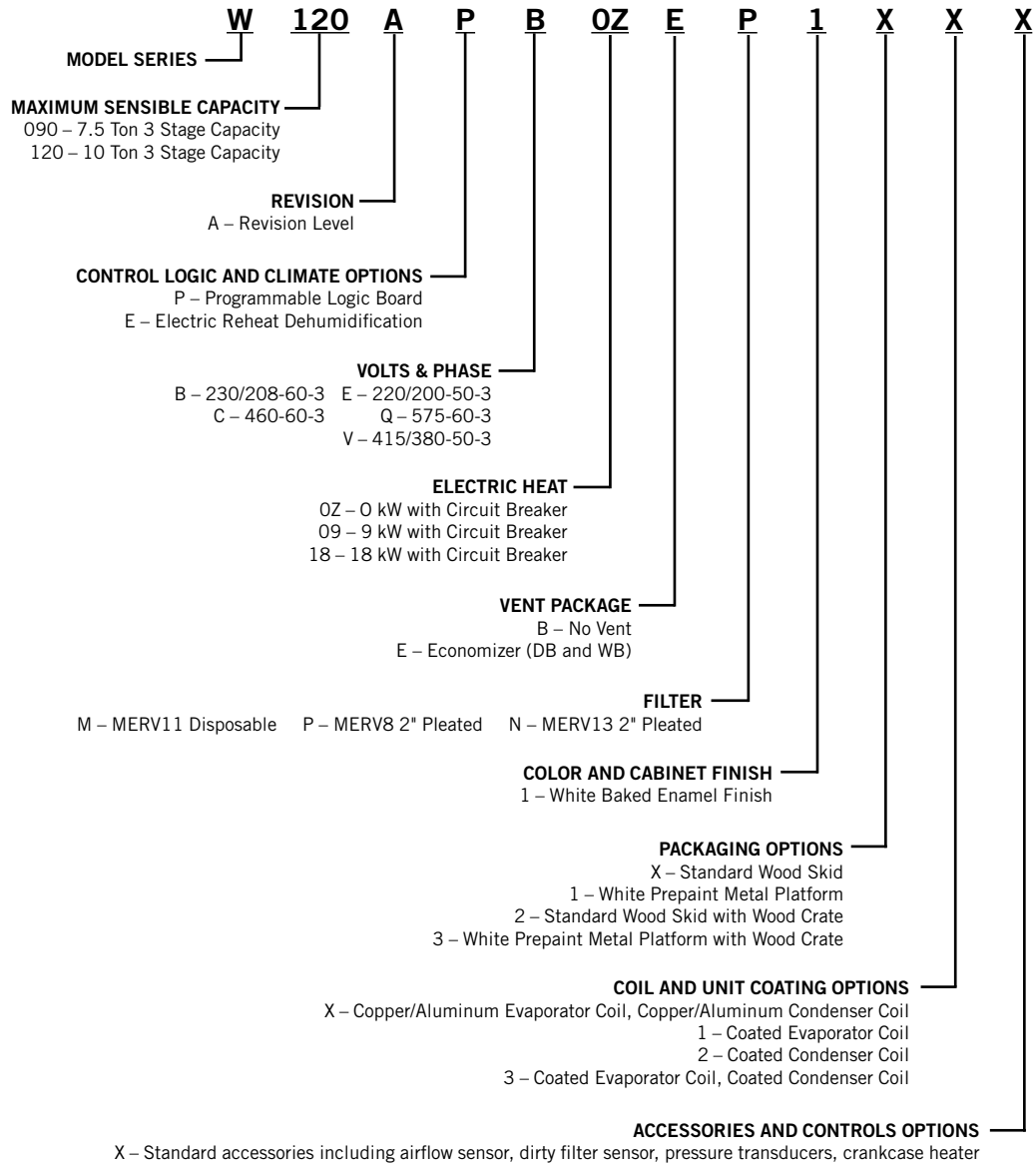

REFRIGERANT INFORMATION

NOTICE

These units require R-410A refrigerant and polyol ester oil.

General

1. Use separate service equipment to avoid cross contamination of oil and refrigerants.
2. Use recovery equipment rated for R-410A refrigerant.
3. Use manifold gauges rated for R-410A (800 PSI/250 PSI low).
4. R-410A is a binary blend of HFC-32 and HFC-125.
5. R-410A is nearly azeotropic—similar to R-22 and R-12. Although nearly azeotropic, charge with liquid refrigerant.
6. R-410A operates at 40-70% higher pressure than R-22, and systems designed for R-22 cannot withstand this higher pressure.
7. R-410A has an ozone depletion potential of zero, but must be reclaimed due to its global warming potential.
8. R-410A compressors use polyol ester oil.
9. Polyol ester oil is hygroscopic; it will rapidly absorb moisture and strongly hold this moisture in the oil.
10. A liquid line dryer must be used—even a deep vacuum will not separate moisture from the oil.
11. Limit atmospheric exposure to 15 minutes.
12. If compressor removal is necessary, always plug compressor immediately after removal. Purge with small amount of nitrogen when inserting plugs.

Topping Off System Charge

If a leak has occurred in the system, Bard Manufacturing recommends reclaiming, evacuating (see criteria above) and charging to the nameplate charge. If done correctly, topping off the system charge can be done without problems.

With R-410A, there are no significant changes in the refrigerant composition during multiple leaks and recharges. R-410A refrigerant is close to being an azeotropic blend (it behaves like a pure compound or single component refrigerant). The remaining refrigerant charge in the system may be used after leaks have occurred. “Top-off” the charge by utilizing the pressure charts on the inner control panel cover as a guideline.

REMEMBER: When adding R-410A refrigerant, it must come out of the charging cylinder/tank as a liquid to avoid any fractionation and to insure optimal system performance. Refer to instructions for the cylinder that is being utilized for proper method of liquid extraction.

Safety Practices

1. Never mix R-410A with other refrigerants.
2. Use gloves and safety glasses. Polyol ester oils can be irritating to the skin, and liquid refrigerant will freeze the skin.
3. Never use air and R-410A to leak check; the mixture may become flammable.
4. Do not inhale R-410A—the vapor attacks the nervous system, creating dizziness, loss of coordination and slurred speech. Cardiac irregularities, unconsciousness and ultimately death can result from breathing this concentration.
5. Do not burn R-410A. This decomposition produces hazardous vapors. Evacuate the area if exposed.
6. Use only cylinders rated DOT4BA/4BW 400.
7. Never fill cylinders over 80% of total capacity.
8. Store cylinders in a cool area, out of direct sunlight.
9. Never heat cylinders above 125°F.
10. Never trap liquid R-410A in manifold sets, gauge lines or cylinders. R-410A expands significantly at warmer temperatures. Once a cylinder or line is full of liquid, any further rise in temperature will cause it to burst.

Important Installer Note

For improved start-up performance, wash the indoor coil with a dishwashing detergent.

R410-A Refrigerant Charge

This wall-mount unit was charged at the factory with the quantity of refrigerant listed on the serial plate. AHRI capacity and efficiency ratings were determined by testing with this refrigerant charge quantity.

Tables 10 and 11 on pages 36 and 37 show nominal pressures for the units. The use of pressure gauges should not be necessary as the measurements are available through the TEC-EYE hand-held diagnostic too. Since many installation specific situations can affect the pressure readings, this information should only be used by certified technicians as a guide for evaluating proper system performance. They shall not be used to adjust charge. If charge is in doubt, reclaim, evacuate and recharge the wall-mount unit to the serial plate charge.

Pressure Service Ports

High and low pressure service ports are installed on all wall-mount units so that the system operating pressures can be observed. Pressures are shown in Tables 11 and 12.

This unit employs high-flow Coremax valves instead of the typical Schrader type valves.

WARNING! Do NOT use a Schrader valve core removal tool with these valves. Use of such a tool could result in eye injuries or refrigerant burns!

To change a Coremax valve without first removing the refrigerant, a special tool is required which can be obtained at www.fastestinc.com/en/SCCA07H. See the replacement parts manual for replacement core part numbers.

TABLE 11
W090A* Cooling Pressures

Cooling Air Temperature Entering Outdoor Coil °F													
Model	Return Air Temp	Pressure	75	80	85	90	95	100	105	110	115	120	125
W090A* Stage 3 ¹	75° DB	Low Side	135	135	135	136	136	137	137	138	140	142	144
	62° WB	High Side	389	379	375	375	381	391	407	427	452	483	518
	80° DB	Low Side	144	144	144	145	145	146	147	148	150	152	154
	67° WB	High Side	399	389	385	385	391	401	417	438	464	495	531
	85° DB	Low Side	149	149	149	150	150	151	152	153	155	157	159
	72° WB	High Side	413	403	398	398	405	415	432	453	480	512	550
W090A* Stage 2 ²	75° DB	Low Side	137	140	142	144	146	149	151	152	154	155	157
	62° WB	High Side	367	356	350	349	354	364	378	399	424	454	489
	80° DB	Low Side	147	150	152	154	156	159	161	163	165	166	168
	67° WB	High Side	376	365	359	358	363	373	388	409	435	466	502
	85° DB	Low Side	152	155	157	159	161	165	167	169	171	172	174
	72° WB	High Side	389	378	372	371	376	386	402	423	450	482	520
W090A* Stage 1 ³	75° DB	Low Side	139	138	138	138	139	140	141	142	144	146	149
	62° WB	High Side	389	382	378	378	382	390	402	417	437	459	487
	80° DB	Low Side	149	148	148	148	149	150	151	152	154	156	159
	67° WB	High Side	399	392	388	388	392	400	412	428	448	471	499
	85° DB	Low Side	154	153	153	153	154	155	156	157	159	161	165
	72° WB	High Side	413	406	402	402	406	414	426	443	464	487	516

Low side pressure ± 4 PSIG
High side pressure ± 10 PSIG

- ¹ Stage 3 is circuit 1 *fully loaded* and circuit 2 *on*.
- ² Stage 2 is circuit 1 *unloaded* and circuit 2 *on*.
- ³ Stage 1 is circuit 1 *unloaded* and circuit 2 *off*.

Tables are based upon **rated CFM** (airflow) across the evaporator coil. If there is any doubt as to correct operating charge being in the system, the charge should be removed and system evacuated and recharged to serial plate charge weight.

NOTE: Pressure table based on high speed condenser fan operation. If condensing pressures appear elevated, check condenser fan wiring. See "Condenser Fan Operation" on page 21.

TABLE 12
W120A* Cooling Pressures

Cooling Air Temperature Entering Outdoor Coil °F													
Model	Return Air Temp	Pressure	75	80	85	90	95	100	105	110	115	120	125
W120A* Stage 3¹	75° DB	Low Side	125	126	127	128	129	130	132	133	135	137	137
	62° WB	High Side	312	334	357	379	403	427	451	476	501	527	553
	80° DB	Low Side	134	135	136	137	138	139	141	142	144	146	147
	67° WB	High Side	320	343	366	389	413	438	463	488	514	540	567
	85° DB	Low Side	139	140	141	142	143	144	146	147	149	151	152
	72° WB	High Side	331	355	379	403	427	453	479	505	532	559	587
W120A* Stage 2²	75° DB	Low Side	136	137	137	138	140	141	142	144	145	147	148
	62° WB	High Side	289	308	330	352	374	398	423	448	474	501	528
	80° DB	Low Side	145	146	147	148	150	151	152	154	155	157	158
	67° WB	High Side	296	316	338	361	384	408	434	459	486	514	542
	85° DB	Low Side	150	151	152	153	155	156	157	159	160	162	164
	72° WB	High Side	306	327	350	374	397	422	449	475	503	532	561
W120A* Stage 1³	75° DB	Low Side	125	127	128	130	131	133	135	136	137	139	141
	62° WB	High Side	311	332	355	377	402	427	452	479	506	534	563
	80° DB	Low Side	134	136	137	139	140	142	144	145	147	149	151
	67° WB	High Side	319	341	364	387	412	438	464	491	519	548	577
	85° DB	Low Side	139	141	142	144	145	147	149	150	152	154	156
	72° WB	High Side	330	353	377	401	426	453	480	508	537	567	597

Low side pressure ± 4 PSIG
High side pressure ± 10 PSIG

- ¹ Stage 3 is circuit 1 *fully loaded* and circuit 2 *on*.
- ² Stage 2 is circuit 1 *unloaded* and circuit 2 *on*.
- ³ Stage 1 is circuit 1 *unloaded* and circuit 2 *off*.

Tables are based upon **rated CFM** (airflow) across the evaporator coil. If there is any doubt as to correct operating charge being in the system, the charge should be removed and system evacuated and recharged to serial plate charge weight.

NOTE: Pressure table based on high speed condenser fan operation. If condensing pressures appear elevated, check condenser fan wiring. See "Condenser Fan Operation" on page 21.

MAINTENANCE

Standard Maintenance Procedures

WARNING

Electrical shock hazard.

Disconnect all power supplies before servicing.

Failure to do so could result in electric shock or death.

CAUTION

Cut hazard.

Wear gloves to avoid contact with sharp edges.

Failure to do so could result in personal injury.

1. Disable system from LC6000 controller (see latest revision of LC6000 Service Instructions 2100-669).
2. Turn off AC breakers at wall-mount units.
3. Check inlet sides of condenser and evaporator coils for obstructions/debris—clean if necessary using a quality manufactured coil cleaning product specific for the evaporator or condenser coil.
 - Condenser coil: For inlet-side cleaning, remove condenser grilles. For outlet-side cleaning, remove condenser fan panel. Unbolt fan from mounting brackets and slide fan outward until lower locking arm drops into position. Pivot fan by lifting fan locking arm. Follow the coil cleaner manufacturer's directions for necessary safety gear and precautions, as well as for application and use. More than one application may be necessary. Rinse thoroughly.
- Evaporator coil: Open filter access panels and remove filters. Apply specific evaporator cleaner directly to the inlet side of coil, being very careful not to overspray into insulation or surrounding panels and wiring. For outlet-side cleaning, remove supply grille and clean from that direction. Residual cleaner and dissolved debris should drip into the drain pan and leave the unit through the condensate hose. More than one application may be necessary. Rinse thoroughly.
4. Manually spin fan and blower motors to ensure they turn freely. All motors are permanently lubricated, so no oil is necessary.
5. Inspect free cooling damper actuator and linkage.
6. Install new air filters.
7. Inspect the control panel of the system.
 - Look for insect or rodent activity and remove any nesting materials.
 - Manually push contactor closed, observe for movement—contactor points should have minimal discoloration, no spalling or other signs of arcing. Replace if doubtful.
 - Check field and factory wiring for tightness and look for signs of overheating (discoloration of terminals or wire insulation).
8. Ensure that supply and return registers are not obstructed, and more importantly, are not recycling the air to one another. Adjust supply louvers if necessary to direct discharge air away from any direct route to the return grille.
9. Re-assemble wall-mount unit, remembering to fasten fan to mounting brackets. Turn breakers back on.
10. Enable system to LC6000 controller (see latest revision of LC6000 Service Instructions 2100-669).
11. Repeat steps for additional wall-mount units.

FIGURE 53
Sensors and Peripheral Devices

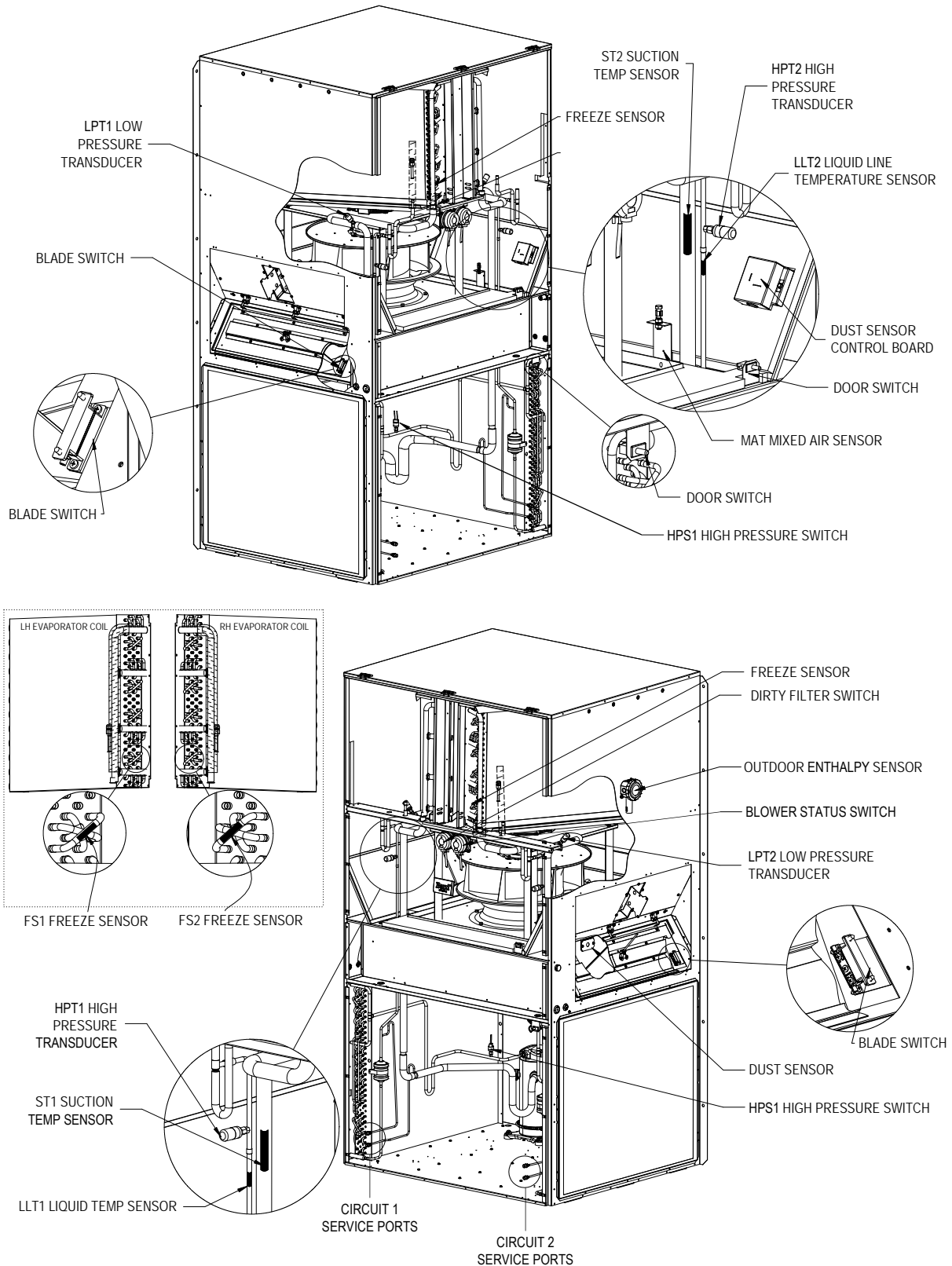
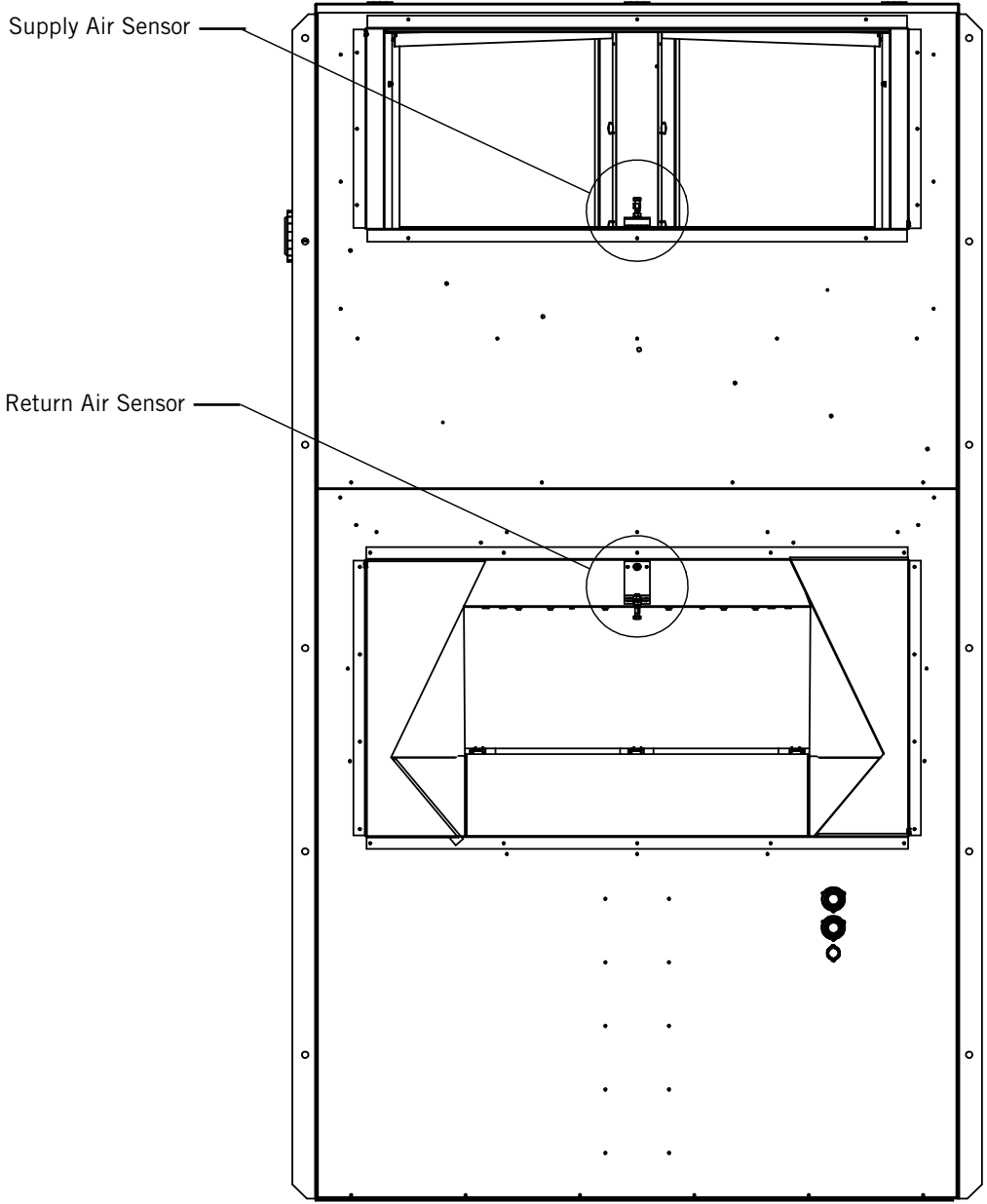

FIGURE 54
Supply and Return Air Sensors

Rear View



8301-089 Outdoor Temperature/Humidity Sensor

FIGURE 55
8301-089 Sensor DIP Switches and Terminal Block

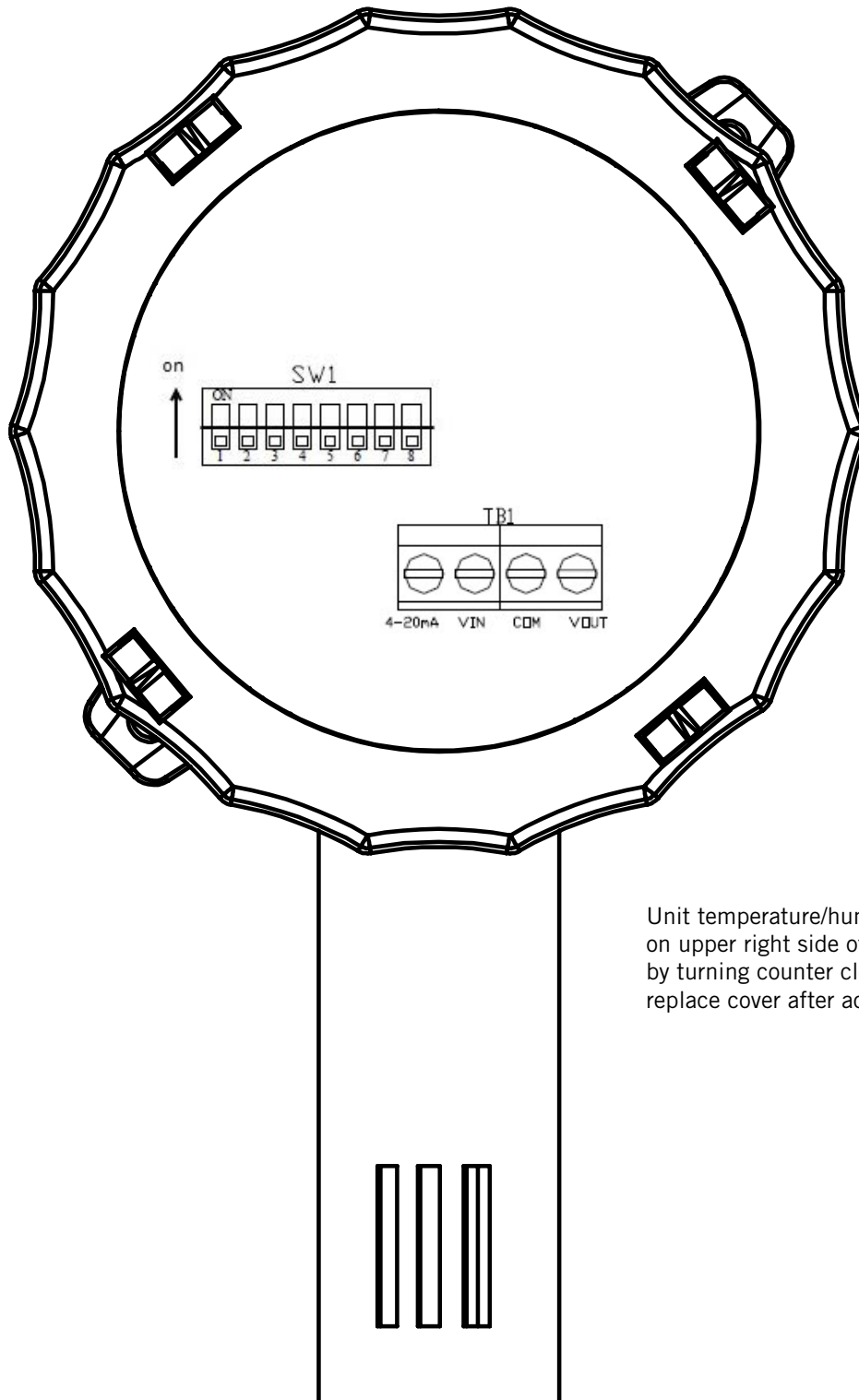

Unit temperature/humidity sensor located on upper right side of unit. Remove cover by turning counter clockwise. Be sure to replace cover after accessing.

TABLE 13
8301-089 Sensor: Temperature/Resistance

Temperature		Resistance	Temperature		Resistance	Temperature		Resistance	Temperature		Resistance
F	C	Ω	F	C	Ω	F	C	Ω	F	C	Ω
-25	-31.7	148,452.94	13	-10.6	48,892.46	51	10.6	18,337.51	89	31.7	7679.76
-24	-31.1	143,910.37	14	-10.0	47,571.97	52	11.1	17,898.38	90	32.2	7515.86
-23	-30.6	139,521.46	15	-9.4	46,291.29	53	11.7	17,471.09	91	32.8	7355.94
-22	-30.0	135,280.55	16	-8.9	45,049.09	54	12.2	17,055.30	92	33.3	7199.88
-21	-29.4	131,182.22	17	-8.3	43,844.12	55	12.8	16,650.65	93	33.9	7047.59
-20	-28.9	127,221.25	18	-7.8	42,675.14	56	13.3	16,256.82	94	34.4	6898.95
-19	-28.3	123,392.63	19	-7.2	41,540.99	57	13.9	15,873.48	95	35.0	6753.88
-18	-27.8	119,691.54	20	-6.7	40,440.51	58	14.4	15,500.34	96	35.6	6612.28
-17	-27.2	116,113.37	21	-6.1	39,372.62	59	15.0	15,137.09	97	36.1	6474.05
-16	-26.7	112,653.66	22	-5.6	38,336.26	60	15.6	14,783.44	98	36.7	6339.11
-15	-26.1	109,308.15	23	-5.0	37,330.40	61	16.1	14,439.11	99	37.2	6207.37
-14	-25.6	106,072.72	24	-4.4	36,354.06	62	16.7	14,103.83	100	37.8	6078.74
-13	-25.0	102,943.44	25	-3.9	35,406.29	63	17.2	13,777.34	101	38.3	5953.15
-12	-24.4	99,916.50	26	-3.3	34,486.17	64	17.8	13,459.38	102	38.9	5830.51
-11	-23.9	96,988.26	27	-2.8	33,592.81	65	18.3	13,149.70	103	39.4	5710.75
-10	-23.3	94,155.21	28	-2.2	32,725.36	66	18.9	12,848.07	104	40.0	5593.78
-9	-22.8	91,413.97	29	-1.7	31,883.00	67	19.4	12,554.26	105	40.6	5479.55
-8	-22.2	88,761.30	30	-1.1	31,064.92	68	20.0	12,268.04	106	41.1	5367.98
-7	-21.7	86,194.07	31	-0.6	30,270.36	69	20.6	11,989.19	107	41.7	5258.99
-6	-21.1	83,709.29	32	0.0	29,498.58	70	21.1	11,717.51	108	42.2	5152.53
-5	-20.6	81,304.06	33	0.6	28,748.85	71	21.7	11,452.79	109	42.8	5048.52
-4	-20.0	78,975.60	34	1.1	28,020.48	72	22.2	11,194.83	110	43.3	4946.91
-3	-19.4	76,721.24	35	1.7	27,312.81	73	22.8	10,943.45	111	43.9	4847.63
-2	-18.9	74,538.41	36	2.2	26,625.18	74	23.3	10,698.45	112	44.4	4750.62
-1	-18.3	72,424.61	37	2.8	25,956.98	75	23.9	10,459.65	113	45.0	4655.83
0	-17.8	70,377.48	38	3.3	25,307.60	76	24.4	10,226.90	114	45.6	4563.20
1	-17.2	68,394.70	39	3.9	24,676.45	77	25.0	10,000.00	115	46.1	4472.67
2	-16.7	66,474.07	40	4.4	24,062.97	78	25.6	9778.81	116	46.7	4384.19
3	-16.1	64,613.46	41	5.0	23,466.62	79	26.1	9563.15	117	47.2	4297.71
4	-15.6	62,810.82	42	5.6	22,886.87	80	26.7	9352.89	118	47.8	4213.18
5	-15.0	61,064.17	43	6.1	22,323.22	81	27.2	9147.86	119	48.3	4130.55
6	-14.4	59,371.62	44	6.7	21,775.16	82	27.8	8947.93	120	48.9	4049.77
7	-13.9	57,731.32	45	7.2	21,242.23	83	28.3	8752.95	121	49.4	3970.79
8	-13.3	56,141.52	46	7.8	20,723.96	84	28.9	8562.79	122	50.0	3893.58
9	-12.8	54,600.50	47	8.3	20,219.91	85	29.4	8377.31	123	50.6	3818.08
10	-12.2	53,106.64	48	8.9	19,729.65	86	30.0	8196.39	124	51.1	3744.26
11	-11.7	51,658.35	49	9.4	19,252.76	87	30.6	8019.91	125	51.7	3672.07
12	-11.1	50,254.11	50	10.0	18,788.84	88	31.1	7847.74			

TABLE 14
8301-089 Sensor: Humidity/mA

RH%	mA Output	RH%	mA Output	RH%	mA Output
0	4.000 mA	34	9.440 mA	68	14.880 mA
1	4.160 mA	35	9.600 mA	69	15.040 mA
2	4.320 mA	36	9.760 mA	70	15.200 mA
3	4.480 mA	37	9.920 mA	71	15.360 mA
4	4.640 mA	38	10.080 mA	72	15.520 mA
5	4.800 mA	39	10.240 mA	73	15.680 mA
6	4.960 mA	40	10.400 mA	74	15.840 mA
7	5.120 mA	41	10.560 mA	75	16.000 mA
8	5.280 mA	42	10.720 mA	76	16.160 mA
9	5.440 mA	43	10.880 mA	77	16.320 mA
10	5.600 mA	44	11.040 mA	78	16.480 mA
11	5.760 mA	45	11.200 mA	79	16.640 mA
12	5.920 mA	46	11.360 mA	80	16.800 mA
13	6.080 mA	47	11.520 mA	81	16.960 mA
14	6.240 mA	48	11.680 mA	82	17.120 mA
15	6.400 mA	49	11.840 mA	83	17.280 mA
16	6.560 mA	50	12.000 mA	84	17.440 mA
17	6.720 mA	51	12.160 mA	85	17.600 mA
18	6.880 mA	52	12.320 mA	86	17.760 mA
19	7.040 mA	53	12.480 mA	87	17.920 mA
20	7.200 mA	54	12.640 mA	88	18.080 mA
21	7.360 mA	55	12.800 mA	89	18.240 mA
22	7.520 mA	56	12.960 mA	90	18.400 mA
23	7.680 mA	57	13.120 mA	91	18.560 mA
24	7.840 mA	58	13.280 mA	92	18.720 mA
25	8.000 mA	59	13.440 mA	93	18.880 mA
26	8.160 mA	60	13.600 mA	94	19.040 mA
27	8.320 mA	61	13.760 mA	95	19.200 mA
28	8.480 mA	62	13.920 mA	96	19.360 mA
29	8.640 mA	63	14.080 mA	97	19.520 mA
30	8.800 mA	64	14.240 mA	98	19.680 mA
31	8.960 mA	65	14.400 mA	99	19.840 mA
32	9.120 mA	66	14.560 mA	100	20.000 mA
33	9.280 mA	67	14.720 mA		

**8620-296 Supply Air Sensor/Return Air Sensor/Mixed Air Sensor/Suction Sensor/
Liquid Sensor**

TABLE 15
8620-296 Sensor: Temperature/Resistance Curve J

Temperature °F	Resistance Ω	Temperature °F	Resistance Ω	Temperature °F	Resistance Ω	Temperature °F	Resistance Ω
-25.0	196871	13.0	56985	53.0	19374	89.0	7507
-24.0	190099	14.0	55284	52.0	18867	90.0	7334
-23.0	183585	15.0	53640	53.0	18375	91.0	7165
-22.0	177318	16.0	52051	54.0	17989	92.0	7000
-21.0	171289	17.0	50514	55.0	17434	93.0	6840
-20.0	165487	18.0	49028	56.0	16984	94.0	6683
-19.0	159904	19.0	47590	57.0	16547	95.0	6531
-18.0	154529	20.0	46200	58.0	16122	96.0	6383
-17.0	149355	21.0	44855	59.0	15710	97.0	6239
-16.0	144374	22.0	43554	60.0	15310	98.0	6098
-15.0	139576	23.0	42295	61.0	14921	99.0	5961
-14.0	134956	24.0	41077	62.0	14544	100.0	5827
-13.0	130506	25.0	39898	63.0	14177	101.0	5697
-12.0	126219	26.0	38757	64.0	13820	102.0	5570
-11.0	122089	27.0	37652	65.0	13474	103.0	5446
-10.0	118108	28.0	36583	66.0	13137	104.0	5326
-9.0	114272	29.0	35548	67.0	12810	105.0	5208
-8.0	110575	30.0	34545	68.0	12492	106.0	5094
-7.0	107010	31.0	33574	69.0	12183	107.0	4982
-6.0	103574	32.0	32634	70.0	11883	108.0	4873
-5.0	100260	33.0	31723	71.0	11591	109.0	4767
-4.0	97064	34.0	30840	72.0	11307	110.0	4663
-3.0	93981	35.0	29986	73.0	11031	111.0	4562
-2.0	91008	36.0	29157	74.0	10762	112.0	4464
-1.0	88139	37.0	28355	75.0	10501	113.0	4367
0.0	85371	38.0	27577	76.0	10247	114.0	4274
1.0	82699	39.0	26823	77.0	10000	115.0	4182
2.0	80121	40.0	26092	78.0	9760	116.0	4093
3.0	77632	41.0	25383	79.0	9526	117.0	4006
4.0	75230	42.0	24696	80.0	9299	118.0	3921
5.0	72910	43.0	24030	81.0	9077	119.0	3838
6.0	70670	44.0	23384	82.0	8862	120.0	3757
7.0	68507	45.0	22758	83.0	8653	121.0	3678
8.0	66418	46.0	22150	84.0	8449	122.0	3601
9.0	64399	47.0	21561	85.0	8250	123.0	3526
10.0	62449	48.0	20989	86.0	8057	124.0	3452
11.0	60565	49.0	20435	87.0	7869		
12.0	58745	50.0	19896	88.0	7686		

8301-057 Blower Status Switch/Dirty Filter Switch

FIGURE 56
8301-057 Air Differential Switch

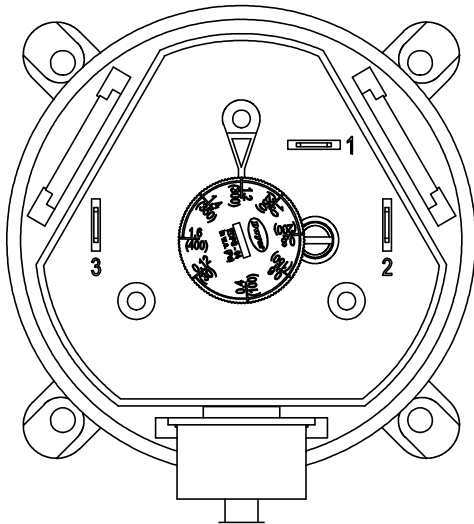

Terminals

- 1 – Normally Closed
- 2 – Normally Open
- 3 – Common

NOTE: Contact position is in resting state.

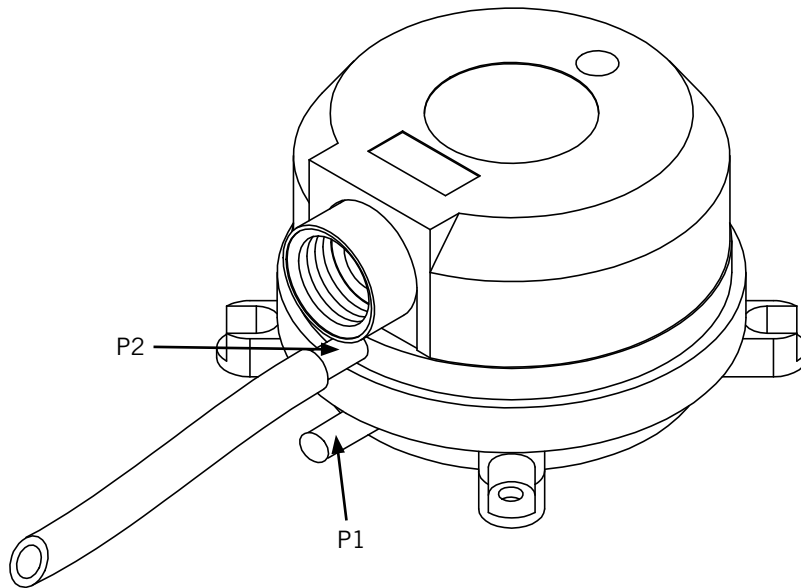

Connect hose to P2

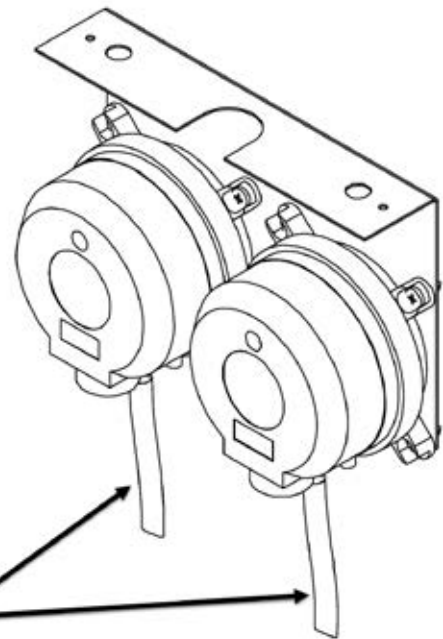

Hoses need to be connected to the P2 port (port closest to front)

Alarm Index

Index	Alarm	Reference (to Manual Section Unless Otherwise Noted)
0	Error in the number of retain memory writings	Call Bard Technical Service
1	Error in retain memory writings	Call Bard Technical Service
2	Circuit 1 Return Air Temperature Sensor Alarm	See Temperature Control section
3	Circuit 1 High Return Air Temperature Alarm	See Temperature Control section
4	Circuit 2 Return Air Temperature Sensor Alarm	See Temperature Control section
5	Circuit 2 High Return Air Temperature Alarm	See Temperature Control section
6	Circuit 1 Mixed Air Temperature Sensor Alarm	See Economizer section
7	Circuit 1 Mixed Air High Temperature	See Economizer section
8	Circuit 1 Mixed Air Low Temperature	See Economizer section
9	Circuit 2 Mixed Air Temperature Sensor Alarm	See Economizer section
10	Circuit 2 Mixed Air High Temperature	See Economizer section
11	Circuit 2 Mixed Air Low Temperature	See Economizer section
12	Circuit 1 Supply Air Temperature Sensor Alarm	See Indoor Airflow section
13	Circuit 1 High Supply Air Temperature Alarm	See Indoor Airflow section
14	Circuit 1 Low Supply Air Temperature Alarm	See Indoor Airflow section
15	Circuit 2 Supply Air Temperature Sensor Alarm	See Indoor Airflow section
16	Circuit 2 High Supply Air Temperature Alarm	See Indoor Airflow section
17	Circuit 2 Low Supply Air Temperature Alarm	See Indoor Airflow section
18	Outdoor Air Temperature Sensor Alarm	See Economizer section
19	Outdoor Air Humidity Sensor Alarm	See Economizer section
20	Circuit 1 Dust Sensor Alarm	See Economizer section
21	Circuit 1 Dust Sensor High Dust Detection Alarm	See Economizer section
22	Circuit 2 Dust Sensor Alarm	See Economizer section
23	Circuit 2 Dust Sensor High Dust Detection Alarm	See Economizer section
24	Circuit 1 Liquid Line Temp Sensor Alarm	See Condenser Fan section
25	Circuit 2 Liquid Line Temp Sensor Alarm	See Condenser Fan section
26	Circuit 1 Liquid Line Pressure Sensor Alarm	See Condenser Fan section
27	Circuit 2 Liquid Line Pressure Sensor Alarm	See Condenser Fan section
28	Circuit 1 Discharge Temp Sensor Alarm	See Condenser Fan section
29	Circuit 2 Discharge Temp Sensor Alarm	See Condenser Fan section
30	Circuit 1 Discharge Pressure Sensor Alarm	See Condenser Fan section
31	Circuit 2 Discharge Pressure Sensor Alarm	See Condenser Fan section
32	Circuit 1 Suction Temperature Sensor Alarm	See Electronic Expansion Valve (EEV) section
33	Circuit 2 Suction Temperature Sensor Alarm	See Electronic Expansion Valve (EEV) section
34	Circuit 1 Suction Pressure Sensor Alarm	See Electronic Expansion Valve (EEV) section

Index	Description	Reference (to Manual Section Unless Otherwise Noted)
35	Circuit 2 Suction Pressure Sensor Alarm	See Electronic Expansion Valve (EEV) section
36	Circuit 1 Low Pressure	See Compressor section
37	Circuit 2 Low Pressure	See Compressor section
38	Circuit 1 High Pressure	See Compressor section
39	Circuit 2 High Pressure	See Compressor section
40	Circuit 1 Damper Failed to Open	See Economizer section
41	Circuit 1 Damper Failed to Close	See Economizer section
42	Circuit 2 Damper Failed to Close	See Economizer section
43	Circuit 2 Damper Failed to Open	See Economizer section
44	Circuit 3 Damper Failed to Open	See Economizer section
45	Circuit 3 Damper Failed to Close	See Economizer section
46	Circuit 4 Damper Failed to Open	See Economizer section
47	Circuit 4 Damper Failed to Close	See Economizer section
48	Circuit 1 Freeze Temperature Sensor Alarm	See Electronic Expansion Valve (EEV) section
49	Circuit 2 Freeze Temperature Sensor Alarm	See Electronic Expansion Valve (EEV) section
50	Circuit 1 Freeze Condition	See Electronic Expansion Valve (EEV) section
51	Circuit 2 Freeze Condition	See Electronic Expansion Valve (EEV) section
52	Circuit 1 Blower Fail Alarm	See Indoor Airflow section
53	Circuit 2 Blower Fail Alarm	See Indoor Airflow section
54	Dirty Filter 1 Alarm	See Indoor Airflow section
55	Dirty Filter 2 Alarm	See Indoor Airflow section
56	Dirty Filter 3 Alarm	See Indoor Airflow section
57	Dirty Filter 4 Alarm	See Indoor Airflow section
58	Circuit 1 Dirty Condenser Coil Alarm	<i>Not currently available</i>
59	Circuit 2 Dirty Condenser Coil Alarm	<i>Not currently available</i>
60	Emergency Ventilation Mode Active	See Economizer section
61	Emergency Cooling Mode Active	See Economizer section
62	Extreme High Return Temp Alarm (Heat Cutout)	
63	Unit Disable/Smoke Detector Alarm	See Unit Disable Option section
64	Circuit 1 Power Loss Detected	
65	Circuit 2 Power Loss Detected	
66	Circuit 1 Low SuperHeat	See Electronic Expansion Valve (EEV) section
67	Circuit 1 Low Evaporation Pressure	See Electronic Expansion Valve (EEV) section
68	Circuit 1 High Evaporation Pressure	See Electronic Expansion Valve (EEV) section
69	Circuit 1 High Condenser Temperature	See Electronic Expansion Valve (EEV) section
70	Circuit 1 Low Suction Pressure	See Electronic Expansion Valve (EEV) section
71	Circuit 1 EEV Motor Error	See Electronic Expansion Valve (EEV) section
72	Circuit 1 Self Tuning Error	See Electronic Expansion Valve (EEV) section
73	Circuit 1 Emergency Close	See Electronic Expansion Valve (EEV) section
74	Circuit 1 High Delta Temperature	See Electronic Expansion Valve (EEV) section
75	Circuit 1 High Delta Pressure	See Electronic Expansion Valve (EEV) section
76	Circuit 1 Range Error	See Electronic Expansion Valve (EEV) section
77	Circuit 1 Service Position Percent	See Electronic Expansion Valve (EEV) section
78	Circuit 1 Valve ID	See Electronic Expansion Valve (EEV) section

Index	Description	Reference (to Manual Section Unless Otherwise Noted)
79	Circuit 2 Low SuperHeat	See Electronic Expansion Valve (EEV) section
80	Circuit 2 Low Evaporation Pressure	See Electronic Expansion Valve (EEV) section
81	Circuit 2 High Evaporation Pressure	See Electronic Expansion Valve (EEV) section
82	Circuit 2 High Condenser Temperature	See Electronic Expansion Valve (EEV) section
83	Circuit 2 Low Suction Pressure	See Electronic Expansion Valve (EEV) section
84	Circuit 2 EEV Motor Error	See Electronic Expansion Valve (EEV) section
85	Circuit 2 Self Tuning Error	See Electronic Expansion Valve (EEV) section
86	Circuit 2 Emergency Close	See Electronic Expansion Valve (EEV) section
87	Circuit 2 High Delta Temperature	See Electronic Expansion Valve (EEV) section
88	Circuit 2 High Delta Pressure	See Electronic Expansion Valve (EEV) section
89	Circuit 2 Range Error	See Electronic Expansion Valve (EEV) section
90	Circuit 2 Service Position Percent	See Electronic Expansion Valve (EEV) section
91	Circuit 2 Valve ID	See Electronic Expansion Valve (EEV) section
92	Th-Tune Device Offline	See latest revision of manual 2100-678
93	Th-Tune Temperature Probe Alarm	See latest revision of manual 2100-678
94	Th-Tune Humidity Probe Alarm	See latest revision of manual 2100-678
95	Th-Tune Clock Board Alarm	See latest revision of manual 2100-678
96	c.pCOe Offline	See Modbus Troubleshooting for MEGA-TEC
97	Offline EBM Blower 1	See Modbus Troubleshooting for MEGA-TEC
98		
99	Offline EBM Blower 2	See Modbus Troubleshooting for MEGA-TEC
100		
101	Offline EBM Fan 1	See Modbus Troubleshooting for MEGA-TEC
102		
103	Offline EBM Fan 2	See Modbus Troubleshooting for MEGA-TEC
104		
105	Circuit 1 Low Return Air Temperature Alarm	See Temperature Control section
106	Circuit 2 Low Return Air Temperature Alarm	See Temperature Control section
107	Panel Switch	See Figure 53

Modbus Troubleshooting for MEGA-TEC

Use the following instructions if alarm 97, 99, 101 or 103 occurs.

1. Disconnect the communication wires from the condenser fan (Figure 57) and unplug the ModBus from the expansion module (C.PCOe) as shown in Figure 58. Verify that the other end of the ModBus is plugged into the upper field bus connection (FieldBus 1) on the PLC board (Figure 59).

FIGURE 57

Disconnect Condenser Fan Communication Wires



FIGURE 58

Unplug Modbus from Expansion Module



FIGURE 59

Verify Modbus is Connected to PLC Board



2. Is the blower motor online?

FIGURE 60

Verify Blower Motor Is Online

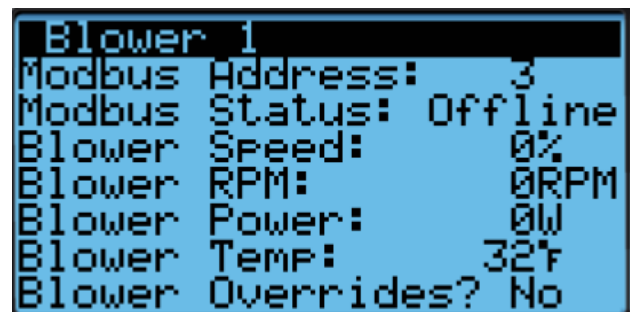

- A. Yes. Proceed to Step 3.
- B. No. Reverse the polarity of the wires coming from the blower motor at the terminal block (terminals 14 and 18, see Figure 61).

FIGURE 61

Reverse Polarity of Wires from Blower Motor

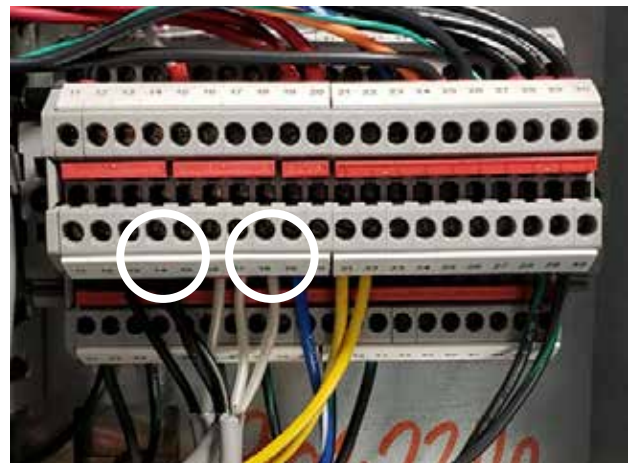

- C. Check for communication, is the blower online?
 - i. Yes. Proceed to Step 3
 - ii. No. Blower must be removed for wiring verification and/or replacement.
 - a. Verify high voltage to blower and check communication wires for short, open or grounded circuits. If a wiring problem is found, make corrections, re-install and verify communication. If no problems are found, replace motor.
3. Reconnect the communication wires at the condenser fan.
 4. Is the blower still online?
 - A. Yes. Proceed to Step 5.
 - B. No. Reverse the polarity on the communication wires at the condenser fan motor (see Figure 57 on page 49). Is the blower online?
 - i. Yes. Proceed to Step 5.
 - ii. No. Verify that none of the wires are shorted or grounded. Then disconnect communication wires at condenser fan motor. Is the blower online?
 - a. Yes. Replace condenser fan motor.
 - b. No. Return to Step 1.
 5. Is the condenser fan online?
 - A. Yes. Proceed to Step 6.
 - B. No. Reverse the communication wires for the condenser motor only (at terminal block in control panel). Is condenser fan online?
 - i. Yes. Verify blower is still online and proceed to Step 6.
 - a. If blower is not online at this point, double check wiring and/or return to Step 1.
 - ii. No. Replace condenser fan.
 6. Plug in expansion module (C.PCOe).
 7. Are the blower and condenser fan still online?
 - A. Yes. Proceed to Step 8.
 - B. No. Reverse the communication wires on the communication terminal block that is plugged into the expansion module (C.PCOe). Are the blower and condenser fan online?
 - i. Yes. Proceed to Step 9.
 - ii. No. Unplug the expansion module (C.PCOe) and verify that the blower and condenser fan are online. Check wiring very carefully to confirm no shorts or grounding has occurred. If unable to establish communication with the condenser fan and blower while plugged

into the expansion module (C.PCOe), but have verified that communication is consistent while not plugged in, the expansion module (C.PCOe) may be bad. Replace the expansion module (C.PCOe).

8. Is the expansion module (C.PCOe) online?
 - A. Yes. Proceed to Step 9.
 - B. No. Check that the address is set to 2 (see Figure 62).

FIGURE 62
Check Address



- c. Is the expansion module (C.PCOe) online?
 - i. Yes. Proceed to Step 9.
 - ii. No. Reverse the communication wires at the communication terminal block that plugs into the expansion module (C.PCOe). Is the expansion module (C.PCOe) online?
 - a. Yes. Verify the blower and fan are still online and proceed to Step 9.
 - b. No. Check wiring very carefully to confirm no shorts or grounding has occurred. If unable to establish communication with the expansion module (C.PCOe) with the blower and condenser fan online, with address set and polarity verified, the expansion module (C.PCOe) will need to be replaced. To verify the expansion module (C.PCOe) is faulty,

the communication wires should be isolated from the blower and condenser fan and only connected to the PLC to establish if communication is possible. If the procedure above has been followed correctly, then the expansion module (C.PCOe) will remain offline. If this is not the case, then wires leading to the condenser fan and blower should be able to be reconnected and communication established. Please contact Bard Technical Service prior to replacing any components if this situation occurs.

9. Replace all covers, tidy up the wiring, clear alarms and resume operations.

Blower Speeds

TABLE 16
Blower Speeds

Mode		Unit	
		7.5 Ton	10 Ton
Free Cooling		57	57
Cooling Stage 1	High Sensible	38.5	48.5
	Nominal	33	42
	Enhanced Latent	27.6	32.6
Cooling Stage 2	High Sensible	52	63
	Nominal	45	57
	Enhanced Latent	36.4	43.8
Cooling Stage 3	High Sensible	52	63
	Nominal	45	57
	Enhanced Latent	36.4	43.8
Heating Stage 1		57	57
Heating Stage 2		57	57
Emergency Ventilation		100	100
Freeze Alarm		80	80
Dehumidification		45	57

FIGURE 63
Ventilation Airflow Paths

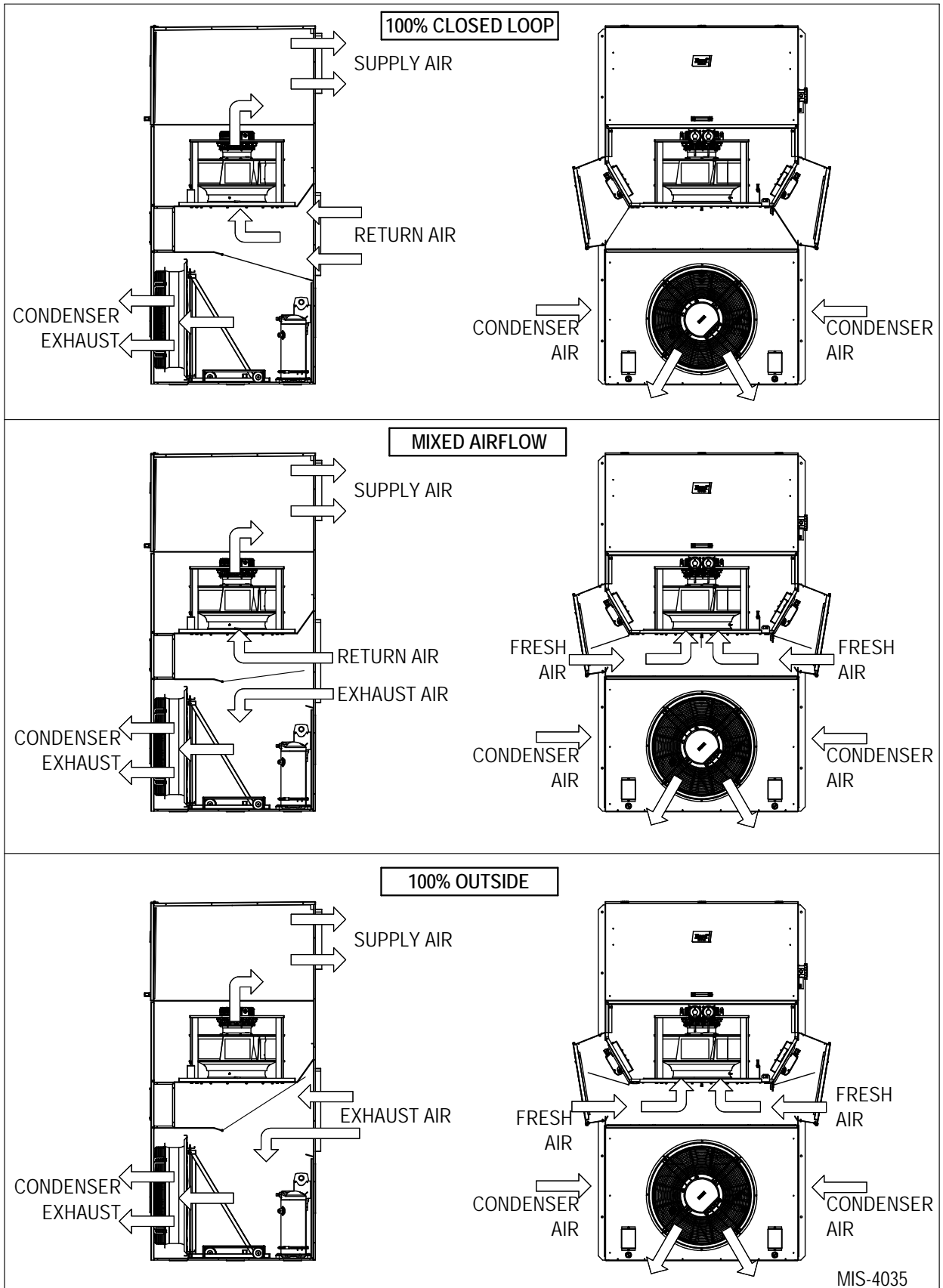

I/O Layout

