INSTALLATION INSTRUCTIONS

Bard Guard BG1000 Anti-Theft System

Description

The purpose of the Bard Guard anti-theft system is to deter coil theft from Bard commercial HVAC systems. The comprehensive system includes both mechanical and electronic methods for deterring theft and notifying owner upon unauthorized unit entry. The Bard Guard anti-theft system is optional on the FUSION-TEC wall-mount units.

The anti-theft system consists of a large interlocking metal frame that encapsulates the unit front access panels and a series of switches wired to a control box. When an attempt is made to steal a coil, an alarm is sounded and a signal sent to a remote network operating center.

The external mounted security frame is both for cabinet security and visual deterrent. The frame is assembled with four 2" x 2" x 1/8" angles that each independently hinge away from the front of the unit. The hinges are internal to the frame angles to prevent tampering and each frame has four captivated security fasteners to prevent attempts at cutting the fastener or removal without the required tool. The security key used for removing the fasteners is shipped in a plastic bag with the unit. The four angles are also interlocked to each other, requiring the four security fasteners be completely removed prior to internal unit access by an authorized technician. The frame is designed to remain attached to the unit at all times for safety and ease of use.

The four plunger switches and the pressure switch monitor the state of the air conditioner. Should the system's pressures change or panels open, indicating an attempt to remove one or both of the coil assemblies from the air conditioner, an alarm will sound through an 80db audio speaker on the unit (a pre-recorded audible warning in English and Spanish) and a signal is sent to a remote network operating center via the LV1000 controller.

Installation

WARNING

Electric shock hazard.

Disconnect VAC and VDC power supplies before servicing.

Failure to do so could result in electric shock or death.

List of Materials and Tools Needed for Installation

Additional hardware and miscellaneous supplies are needed for installation. These items are field supplied and must be sourced before installation. This list also includes tools needed for installation.

- Personal protective equipment/safety devices/anti-static wrist straps
- Miscellaneous hand and power tools and jobsite or shop materials, including 7/8" socket (for tri-groove socket – security key) and multipurpose spray lubricant (for frame hinges)
- Electrical supplies:
 - 18 gauge shielded wire (for communication wiring)
 - Minimum 16, maximum 14 gauge wire (for supply wiring)
 - Miscellaneous electrical supplies including rigid/flexible conduit and fittings, wire connectors and supports

Refer to the National Electrical Code (NEC) for complete current carrying capacity data on the



Climate Control Solutions

Bard Manufacturing Company, Inc.
Bryan, Ohio 43506
www.bardhvac.com

Manual: 2100-672C
Supersedes: 2100-672B
Date: 10-20-17

various insulation grades of wiring material. All wiring must conform to NEC and all local codes.

IMPORTANT: When working with circuit board components, Bard recommends the use of an anti-static wrist strap to prevent static electricity shorts to electronic controls.

1. Mounting the BG1000 Controller

The controller can be installed anywhere inside the shelter that is suitable, preferably at eye level and near the LV1000 controller. The dimensions of the BG1000 controller are 5-1/2" x 11-1/2" x 3". Four mounting holes are provided for mounting to the wall and holes for conduit connection are provided in the base and sides of the controller. Use #12 screws to secure the controller in its intended location. **Conduit is recommended for all wiring.**

The BG1000 controller includes a fused power supply terminal in the terminal block. Before connecting wires to the terminal block, confirm that the fuse in the fuse holder is in the proper position (active) as shown in Figure 1.

The BG1000 controller is not weatherproof and is intended for use inside weathertight structures only.

FIGURE 1

BG1000 Fused Power Supply Terminal



2. Connecting Wall-Mount Units to BG1000 Controller

The wall-mount unit front panel plunger switches and pressure switch are wired in series and terminated at terminals 7 and 8 on a terminal block inside the control panel of the wall-mount unit. The speaker wires are also terminated on the terminal block at terminals 5 and 6. Run a total of four wires (two for the switches and two for the speaker) from the wall-mount unit terminal block

to the Bard Guard controller in the shelter. Up to four units can be connected to a single BG1000. **The system is limited to using two speakers.**

Use 18 gauge shielded cable to connect the switches and speakers (via terminal block) to the BG1000 controller. The BG1000 wires can be run through the same conduit as the FUSION-TEC unit communication wires.

Refer to Figure 2 and Table 1 for terminal block reference and connection points from the wall-mount unit to the BG1000 and the BG1000 to the LV1000 controller.

FIGURE 2
BG1000 Terminal Block

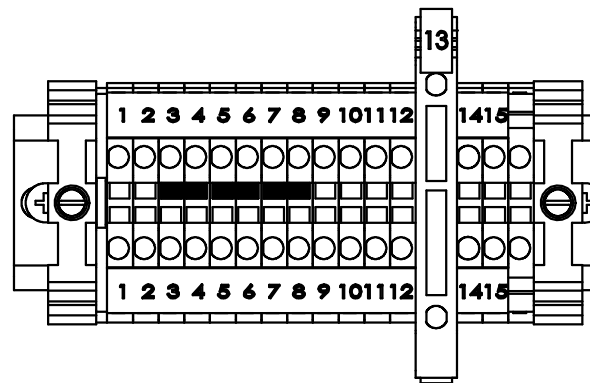

- Terminals 1-8 are switch connections (from FUSION-TEC unit)
- Terminals 9-10 are relay contacts for remote notification (to LV controller)
- Terminals 12-13 (polarity sensitive) are -48VDC power (to LV controller)
- Terminals 14-15 are speaker connections (from FUSION-TEC unit)

3. Connecting BG1000 Controller to LV1000

The BG1000 needs to be connected to the LV1000 controller to receive power and send remote alarm notification. The BG1000 power supply wires and remote notification wires can be run through the same conduit.

Supply Wiring

The BG1000 controller is powered by -48VDC from the LV1000 controller. Field-supplied supply wiring should be minimum 16 gauge, maximum 14 gauge. **These connections are polarity sensitive.** Run wiring from BG1000 terminals 12 (+) and 13 (-) to LV1000 terminals 1 (+) and 2 (-) as shown in Figure 3. Although a blocking diode is in place to protect the system, it is very important that the supply wiring is installed properly.

A reliable earth ground must be connected in addition to any grounding from conduit. Grounding bolts and nuts are supplied with the BG1000. Use the bolts and nuts with a field-supplied grounding lug to connect ground.

TABLE 1
Terminal Block Schedule for Connecting FUSION-TEC Units to Bard Guard

Wall-Mount Unit	LV Controller Terminal #	FUSION-TEC Terminal #	BG1000 Terminal #
1		7, 8	1, 2
2		7, 8	3, 4 ^①
3		7, 8	5, 6 ^①
4		7, 8	7, 8 ^①
	14		9
	15		10
	1 (+)		12 (+)
	2 (-)		13 (-)
		5 ^②	14
		6 ^②	15

- ① Jumpers must be removed from the BG1000 terminal block when using these terminals. See wiring diagram in Figure 7 on page 6 for information on which jumpers to remove.
- ② Limit two speakers per Bard Guard anti-theft system.

FIGURE 3
Connecting BG1000 to LV1000 Controller
(-48VDC Power Supply and Remote Notification)

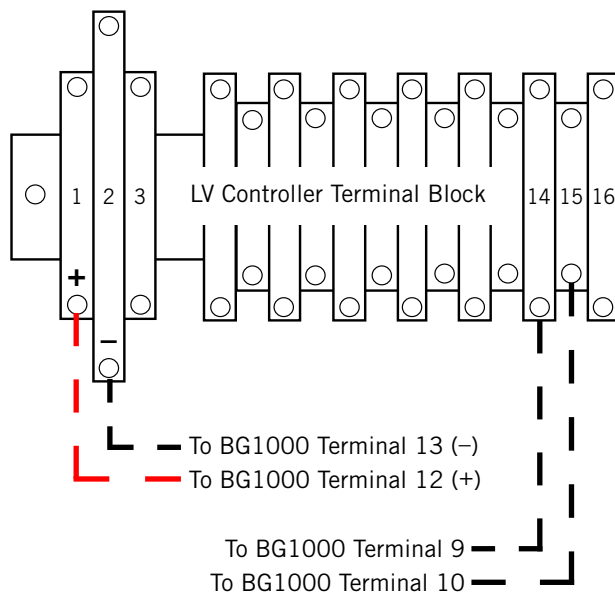

Remote Notification Communication Wiring

The LV will indicate an anti-theft alarm when the BG1000 controller indicates an alarm to the anti-theft input on the LV. This alarm will open an alarm relay output to the remote network operating center for remote notification. Connect BG1000 terminals 9 and 10 to LV1000 terminals 14 and 15 using 18 gauge shielded cable as shown in Figure 3.

When the input no longer indicates a theft, the alarm will automatically clear and the alarm relay will return to its normal state.

4. Enabling Anti-Theft in LV1000

In order to operate properly, the Bard Guard anti-theft system must be enabled in the LV1000 controller. Refer to **Anti-Theft Alarm** in the latest version of LV1000 Service Instructions manual 2100-673 for information on enabling the anti-theft in the LV and changing direction of the alarm input and output (if required).

At this stage, the installation of the BG1000 controller is complete.

Operation

Arming System

When the system powers up for the first time, it arms automatically. Once all sensors are satisfied (circuit closed), a red indicator light will be illuminated on the front of the BG1000 controller. If system does not arm when first powered, press the DISARM/RESET button once to be sure the red light is on.

When the red LED is illuminated, the system is armed. When the sensors are not satisfied (circuit is open), the red LED will turn off and the following will happen:

- An alarm will sound with a prerecorded message. The alarm will continue to sound for up to 10 minutes depending on the preset time (default approximately 2-1/2 minutes—see Figure 4 on page 4 for information on adjusting alarm time).

FIGURE 4
Adjusting Timers on BG1000 Security Board

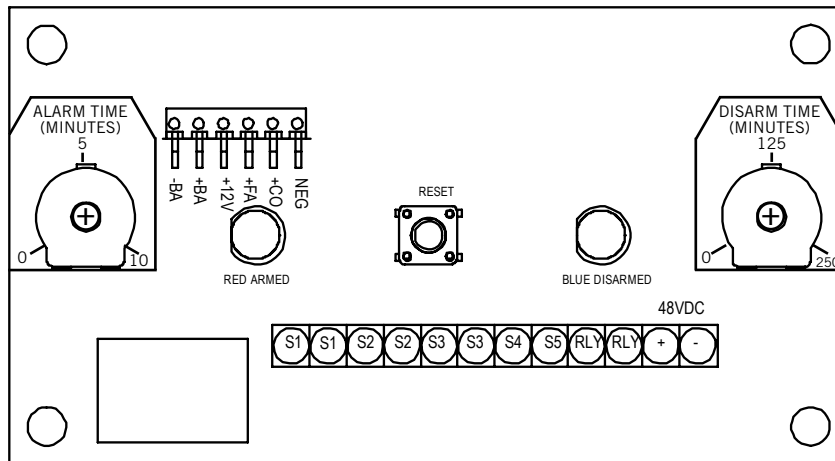

Use small screwdriver to adjust the ALARM TIME and DISARM TIME timers.
 Defaults: ALARM TIME approx. 2.5 minutes, DISARM TIME approx. 15 minutes.

- The ALARM function key on the LV1000 controller will be activated. The alarm is acknowledged by pressing the ALARM key. This calls up the anti-theft alarm display screen (see Figure 5). When the input no longer indicates a theft, the alarm will automatically clear and the alarm relay will return to its normal state.
- An alarm signal will be sent to the remote network operating center via the LV controller.

The alarm can be reset temporarily at any time while the alarm is sounding by pushing the DISARM/RESET button or closing the circuit.

If the alarm has exceeded the time limit, press DISARM/RESET to rearm the system and once again the red LED will be illuminated.

FIGURE 5
LV1000 Anti-Theft Alarm Screen



Disarming System

While the system is powered, push DISARM/RESET button. Once the button is pushed, the blue LED will illuminate. As long as the blue LED is illuminated, the Bard Guard system is disarmed and will remain disarmed depending on the preset time for up to 250 minutes (default approximately 15 minutes—see Figure 4 for information on adjusting disarm time). After the preset time expires, the system will rearm automatically.

For situations that require an individual unit to be disconnected from the Bard Guard security system for an extended period of service time (longer than the maximum 250 minutes disarm time), place a jumper across the appropriate terminals on the BG1000 terminal block to temporarily remove the unit from the security system. **Be sure to remove the jumper from the terminals after service has been completed.**

FIGURE 6
Bard Guard Unit Components (Switches and Speaker) Wiring Diagram

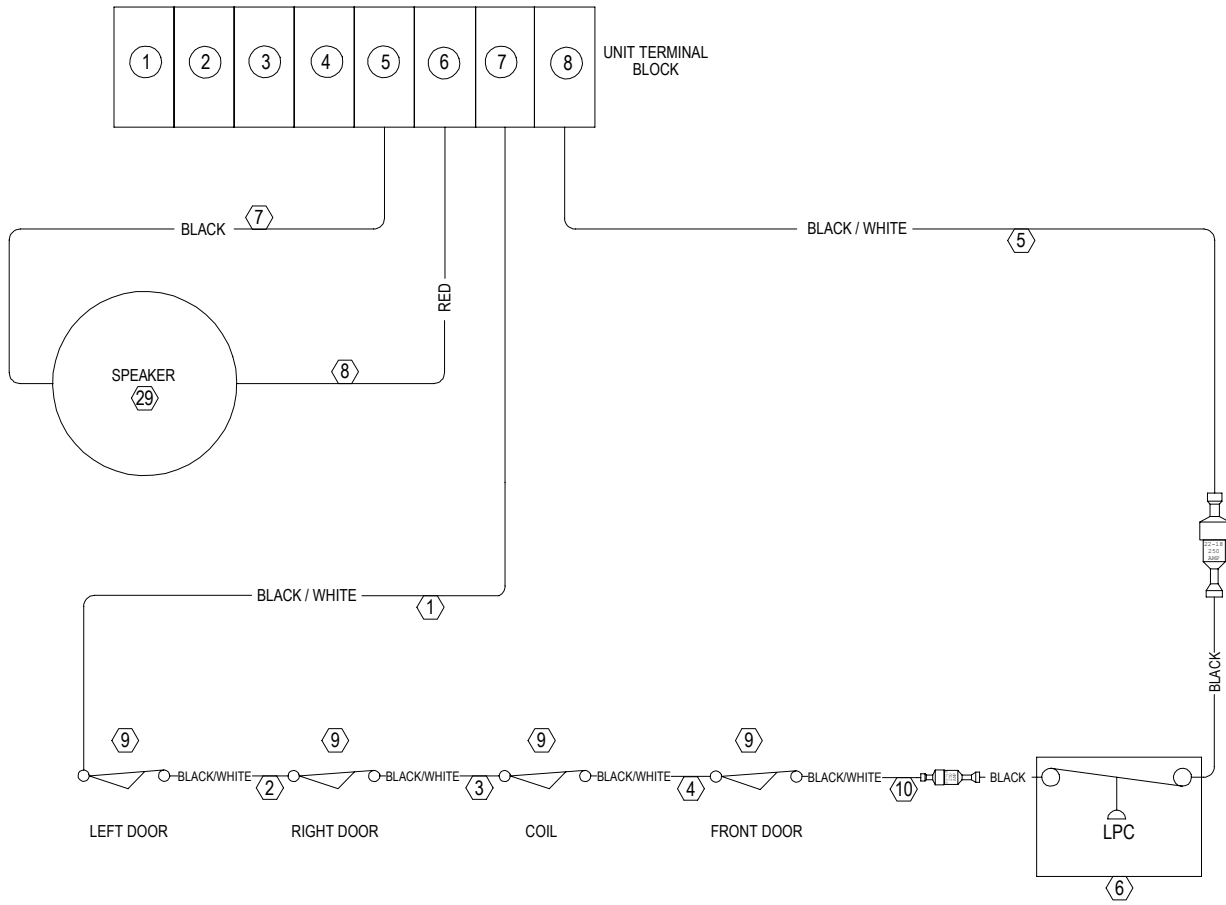

4209-101 B

**FIGURE 7
BG1000 Wiring Diagram**

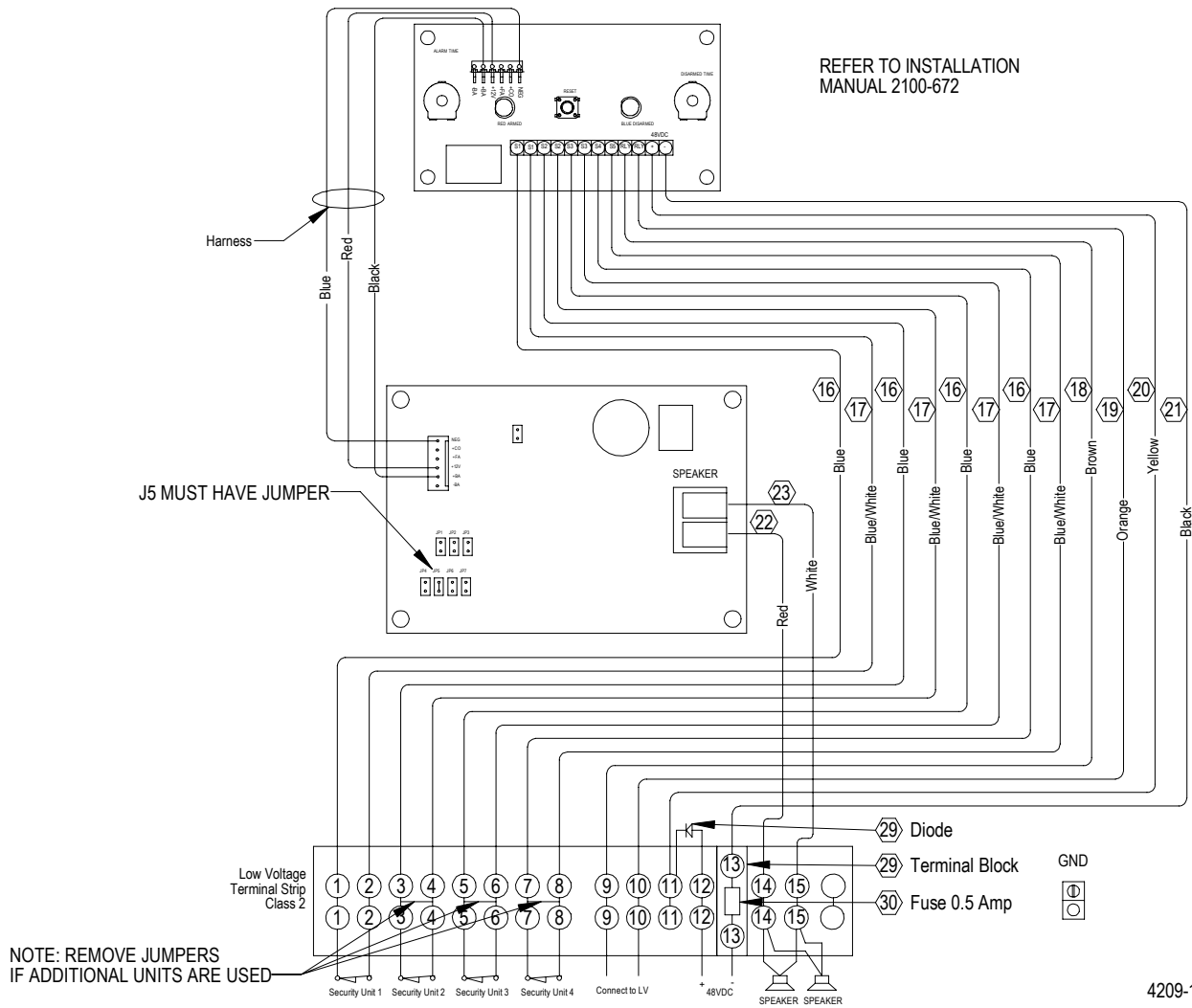

4209-100 C

BG1000 Replacement Parts

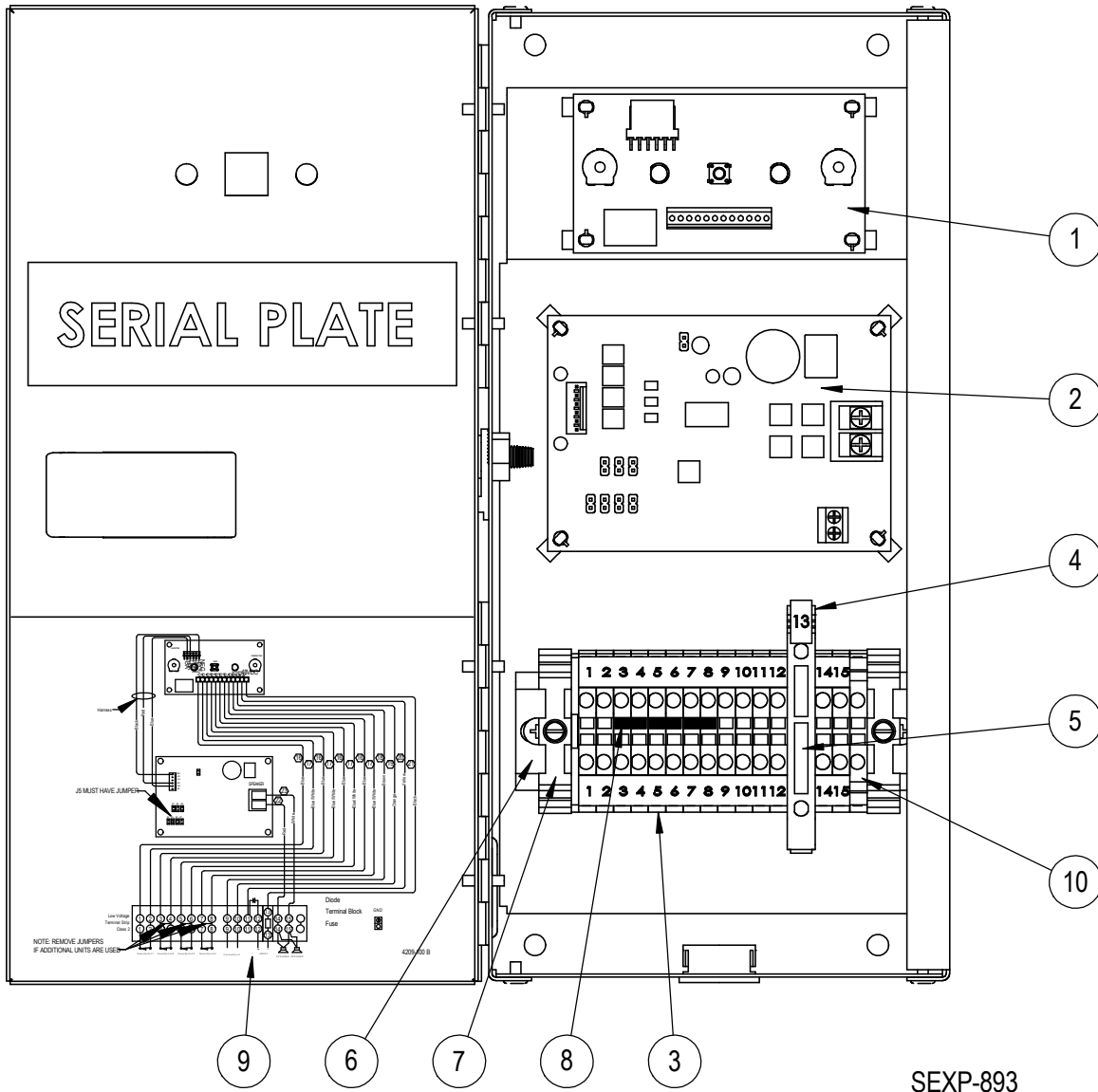

SEXP-893

Dwg. No.	Part Number	Description	BG1000
1	8612-062	Security Board	X
2	8301-071	Voice Driver Module	X
3	8611-150	Terminal Block	14
4	8614-061	Fused Terminal Block	1
5	8614-060	0.5 Amp Fuse	1
6	8611-205	Din Rail	1
7	8611-144	End Clamp (for Din Rail)	2
8	8611-194	Jumper 2 Position	3
9	4209-100A	Wiring Diagram	1
10	8611-215	Ground Terminal Block	1

Bard Guard Anti-Theft System Wall-Mount Unit Replacement Parts

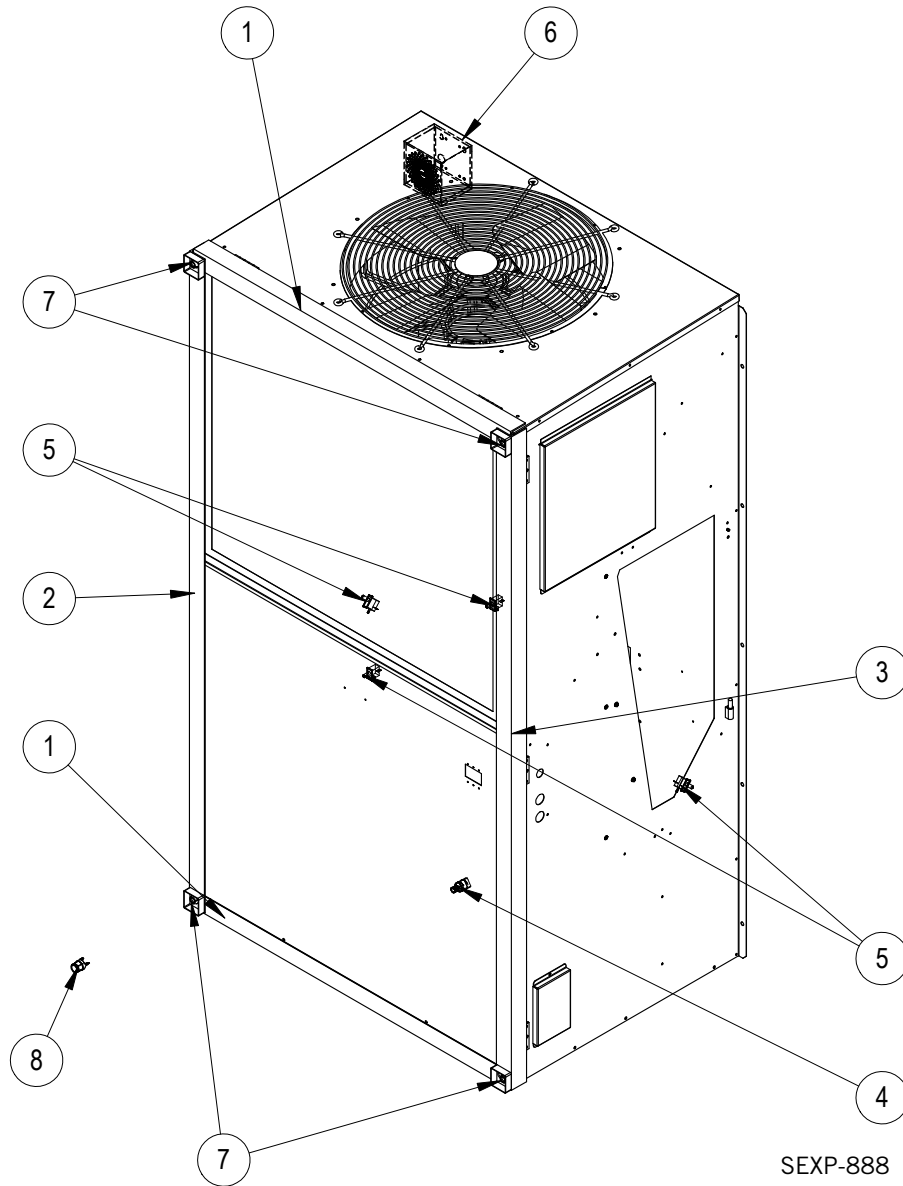

Dwg No.	Part Number	Description	HR36AP*	HR58AP*
1	9050-001	Frame Top/Bottom	2	2
2	9050-002	Left Frame Side	1	1
3	9050-003	Right Frame Side	1	1
4	8406-135	Low Pressure Switch	1	1
5	8406-156	Panel Switch	4	4
6	910-2038	Speaker Assembly	1	1
7	1012-346	Tri-Groove Nut	4	4
8	2151-022	Tri-Groove Socket – Security Key	1	1