INSTALLATION INSTRUCTIONS

Bard Air Conditioning System



FUSION-TEC® HR Series Wall-Mount Air Conditioner

Models:

HR35BPA HR35BPB
HR36BPA HR36BPB
HR58BPA HR58BPB



LV1000-300 Lead/Lag Controller

NOTE: LV1000 controller is required for operation when FUSION-TEC HR**BP* wall-mount units are used.



Climate Control Solutions

Bard Manufacturing Company, Inc.
Bryan, Ohio 43506
www.bardhvac.com

Manual: 2100-674J
Supersedes: 2100-674I
Date: 6-11-20

CONTENTS

General Information	4	Additional Information.....	46
Air Conditioning System.....	4	Menu Screens and Password Levels.....	46
Wall-Mount Air Conditioner Units.....	4	Setpoints.....	46
Controller	4	Calibrating Sensors.....	46
General	5	Reset to Factory Defaults	47
Shipping Damage.....	5	Remote Indoor Temperature/Humidity Sensor	
Additional Publications	5	Orientation	49
List of Necessary Materials/Tools.....	6		
Site Preparation.....	7	FIGURES	
Model Identification.....	7	Figure 1	FUSION-TEC HR Series Model
New Shelter Installation vs. Retrofit Installation ..	7	Nomenclature	7
Minimum Clearance.....	8	Figure 2	Dimensions
Clearance to Combustibles	8	Figure 3	Prefilling Traps on Indoor Drain Pan
Wall-Mount Unit Mounting.....	10	Hoses.....	11
Mounting the Units.....	10	Figure 4	Hanging Front Access Panel to Allow
Supply Air Grill Installation	12	Access to Control Panel	11
Wall-Mount Unit Wiring	18	Figure 5	Fold-Out Diverter.....
Main Power Wiring.....	18	Figure 6	Downward Curved Diverter Blades
Unit Control Voltage Wiring.....	20	Figure 7	View of Installed Grille
Software Update.....	22	Figure 8	HR35 Mounting Instructions.....
Software Information	22	Figure 9	HR36/HR58 Mounting Instructions....
FUSION-TEC Software Information	22	Figure 10	Electric Heat Clearance.....
LV1000 Software Information.....	22	Figure 11	Wall Mounting Instructions
Software Versioning Guide	22	Figure 12	Wall Mounting Instructions
Preliminary Start Up.....	23	Figure 13	Common Wall Mounting Installations..
Running in Orphan Mode	23	Figure 14	Wire Routing.....
LV1000 Controller Installation.....	24	Figure 15	WIRING: VAC Supply Wiring
LV1000 Controller	25	Landing Points	19
Mounting the LV Controller.....	25	Figure 16	Side Communication and Power Wire
Installing Remote Indoor		Entrances (Recommended).....	19
Temperature/Humidity Sensor(s).....	26	Figure 17	Rear Communication and Power Wire
Additional LV1000 Connections.....	28	Entrances (Optional)	20
Communication Wiring.....	29	Figure 18	Adjusting the 230/208 VAC
LV1000 Supply Wiring.....	34	Transformer.....	21
System Set Up	37	Figure 19	FUSION-TEC HR Series Software Info ..
TEC-EYE™ Hand-Held Diagnostic Tool.....	37	Figure 20	LV1000 Software Info
Tec-Eye Status Screen	37	Figure 21	Cool and Heat Setpoints.....
Setting Up Wall-Mount Units for Operation	38	Figure 22	Typical LV1000 Component Location ..
1. Address Each Wall-Mount Unit	38	Figure 23	LV1000 Fused Power Supply Terminal
2. Execute a Run Test on Each Unit.....	38	Figure 24	Remote Indoor Temperature/Humidity
3. Clear Unit Alarm Logs on Each Unit.....	39	Sensor Installation.....	26
Setting Up LV1000 for Operation.....	40	Figure 25	Additional Remote Sensor Installation
LV1000 Status Screen.....	40	Figure 26	Communication Wiring (Daisy Chain) ..
4. Set LV Controller Timezone and		Figure 27	Communication Wiring (Alt. Method) ..
Date/Time.....	40	Figure 28	Placement of Communication Filters ..
5. Configure NOC Relay Outputs	41	Figure 29	Communication Wiring: Termination
6. Configure Sensors.....	42	at the Controller	31
7. Enter Total Number of Units.....	44	Figure 30	Communication Wiring: Termination
8. Verify Units are Online.....	45	at the First Wall-Mount Unit	32
9. Clear Controller Alarm Logs	45	Figure 31	Communication Wiring: Termination
10. Complete Installation.....	45	at Additional Wall-Mount Units	33
		Figure 32	LV1000-300 Controller Supply Wiring
		Figure 33	Controller Grounding Posts
		Figure 34	WIRING: LV1000-300 Wiring Diagram..
			36

Figure 35	TEC-EYE Connection to Unit Control...	37
Figure 36	TEC-EYE Display and Interface	38
Figure 37	Changing Unit Setup Values	38
Figure 38	Changing Economizer Control Type	38
Figure 39	Executing Run Test.....	39
Figure 40	Run Test Summary.....	39
Figure 41	Run Test: Motors & Sensors	39
Figure 42	Run Test: A/C Circuit.....	39
Figure 43	Clearing Unit Alarm Logs.....	39
Figure 44	Changing Timezone.....	40
Figure 45	LV1000 Controller Display/Interface ...	40
Figure 46	Setting Controller Date and Time.....	41
Figure 47	Changing Output Values	41
Figure 48	Changing HVAC Fail Outputs.....	42
Figure 49	Changing HVAC Maintenance Outputs	42
Figure 50	Configuring Indoor Humidity 1 Sensor	43
Figure 51	Configuring Indoor Humidity 2 Sensor	43
Figure 52	Configuring Indoor Humidity 3 Sensor	43
Figure 53	Configuring Indoor Temp 1 Sensor.....	44
Figure 54	Configuring Indoor Temp 2 Sensor.....	44
Figure 55	Configuring Indoor Temp 3 Sensor.....	44
Figure 56	Entering Total Number of Units.....	44
Figure 57	Verifying Units.....	45
Figure 58	Clearing LV1000 Alarm Logs.....	45
Figure 59	Adjusting Sensor Offset Value	46
Figure 60	Restoring Factory Default Settings.....	47
Figure 61	Current Sensor Orientation	49
Figure 62	Earlier Sensor Orientation.....	49

TABLES

Table 1	Clearance Required for Service Access and Adequate Condenser Airflow	8
Table 2	Minimum Clearance Required to Combustible Materials.....	8
Table 3	Electrical Specifications	18
Table 4	Software Versioning Guide	22
Table 5	LV1000-300 Terminal Block Index.....	35
Table 6	LV1000/TEC-EYE Passwords (Defaults).	46
Table 7	Unit Status Messages.....	48
Table 8	LV1000 Status Messages	48

 **WARNING**

Electrical shock hazard.

Have a properly trained individual perform these tasks.

Failure to do so could result in electric shock or death.

 **WARNING**

Fire hazard.

Maintain minimum 1/4" clearance between the supply flange and combustible materials.

Failure to do so could result in fire causing damage, injury or death.

 **WARNING**

Heavy item hazard.

Use more than one person to handle unit.

Failure to do so could result in unit damage or serious injury.

 **CAUTION**

Cut hazard.

Wear gloves to avoid contact with sharp edges.

Failure to do so could result in personal injury.

GENERAL INFORMATION

Air Conditioning System

This Bard air conditioning system is composed of FUSION-TEC HR Series wall-mounted air conditioners matched with an LV1000 lead/lag controller. The wall mounts are specifically engineered for telecom/motor control center rooms.

NOTE: The LV1000 lead/lag controller and FUSION-TEC HR Series wall-mount units are designed specifically to work together. The controller cannot run other Bard models or other brands of systems, nor can other controllers run the HR Series wall-mount units. They are a complete system, and must be used together.

Wall-Mount Air Conditioner Units

The FUSION-TEC HR Series wall-mount units operate on VAC power. The units will supply 100% of rated cooling airflow in free cooling mode with ability to exhaust the same amount through the unit itself without any additional relief openings in the shelter.

Each of these units are fully charged with refrigerant and may have optional auxiliary heat.

Controller

LV1000 controller and accessories included are shown below.

LV1000-300 Series Controller and Accessories Included with Controller



(1) LV1000 Programmable Logic Controller



(1) TEC-EYE™ Hand-Held Diagnostic Tool
Bard P/N 8301-059



(1) Remote Temperature/Humidity Sensor¹
Bard P/N 8403-079



(1) 35' 5-Wire 18 Gauge Shielded Cable



(2) Communication EMI Filters
Bard P/N 8301-055

Optional Sensors:



Remote Temperature/Humidity Sensor¹
Bard P/N 8403-079



Remote Temperature Only Sensor
Bard P/N 8301-058

¹ One remote temperature/humidity sensor is included with the LV1000 controller. Up to two additional remote temperature/humidity sensors can be purchased and installed. Temperature-only sensors (Bard P/N 8301-058) may be used instead of the additional temperature/humidity sensors, but will also need to be purchased separately. Temperature-only sensors require field-supplied 2-wire shielded cable.

General

The equipment covered in this manual is to be installed by trained, experienced service and installation technicians.

The refrigerant system is completely assembled and charged. All internal wiring is complete.

The unit is designed for use without duct work. Flanges are provided for transition from unit to wall grilles. A field-supplied wall sleeve may be necessary between the supply and return flanges and grilles.

These instructions explain the recommended method to install the air cooled self-contained unit and the electrical wiring connections to the unit.

These instructions and any instructions packaged with any separate equipment required to make up the entire air conditioning system should be carefully read before beginning the installation. Note particularly any tags and/or labels attached to the equipment.

While these instructions are intended as a general recommended guide, they do not supersede any national and/or local codes in any way. Authorities having jurisdiction should be consulted before the installation is made. See **Additional Publications** for information on codes and standards.

Sizing of systems for proposed installation should be based on heat loss and heat gain calculations made according to methods of Air Conditioning Contractors of America (ACCA). The supply flange should be installed in accordance with the *Standards of the National Fire Protection Association for the Installation of Air Conditioning and Ventilating Systems of Other Than Residence Type, NFPA No. 90A*, and *Residence Type Warm Air Heating and Air Conditioning Systems, NFPA No. 90B*. Where local regulations are at a variance with instructions, installer should adhere to local codes.

Shipping Damage

Upon receipt of equipment, the cartons should be checked for external signs of shipping damage. If damage is found, the receiving party must contact the last carrier immediately, preferably in writing, requesting inspection by the carrier's agent. These units must remain in upright position at all times.

Additional Publications

These publications can help when installing the air conditioner. They can usually be found at the local library or purchased directly from the publisher. Be sure to consult the current edition of each standard.

National Electrical Code	ANSI/NFPA 70
Standard for the Installation of Air Conditioning and Ventilating Systems	ANSI/NFPA 90A
Standard for Warm Air Heating and Air Conditioning Systems	ANSI/NFPA 90B
Load Calculation for Residential Winter and Summer Air Conditioning	ACCA Manual J

For more information, contact these publishers:

Air Conditioning Contractors of America (ACCA)

1712 New Hampshire Ave. N.W.
Washington, DC 20009
Telephone: (202) 483-9370 Fax: (202) 234-4721

American National Standards Institute (ANSI)

11 West Street, 13th Floor
New York, NY 10036
Telephone: (212) 642-4900 Fax: (212) 302-1286

American Society of Heating, Refrigeration and Air Conditioning Engineers, Inc. (ASHRAE)

1791 Tullie Circle, N.E.
Atlanta, GA 30329-2305
Telephone: (404) 636-8400 Fax: (404) 321-5478

National Fire Protection Association (NFPA)

Batterymarch Park
P. O. Box 9101
Quincy, MA 02269-9901
Telephone: (800) 344-3555 Fax: (617) 984-7057

ANSI Z535.5 Definitions:

DANGER: Indicate[s] a hazardous situation which, if not avoided, will result in death or serious injury. The signal word "DANGER" is to be limited to the most extreme situations. DANGER [signs] should not be used for property damage hazards unless personal injury risk appropriate to these levels is also involved.

WARNING: Indicate[s] a hazardous situation which, if not avoided, could result in death or serious injury. WARNING [signs] should not be used for property damage hazards unless personal injury risk appropriate to this level is also involved.

CAUTION: Indicate[s] a hazardous situation which, if not avoided, could result in minor or moderate injury. CAUTION [signs] without a safety alert symbol may be used to alert against unsafe practices that can result in property damage only.

NOTICE: [this header is] preferred to address practices not related to personal injury. The safety alert symbol shall not be used with this signal word. As an alternative to "NOTICE" the word "CAUTION" without the safety alert symbol may be used to indicate a message not related to personal injury.



LIST OF NECESSARY MATERIALS/TOOLS

Additional hardware and miscellaneous supplies are needed for installation. These items are field supplied and must be sourced before installation. This list also includes tools needed for installation.

List of Materials/Tools

- Personal protective equipment/safety devices/ anti-static wrist straps
- SGR-5W Supply Grille and RGR-5W Return Grille
- Field-fabricated sleeves (if necessary)
- Bottom mounting bracket #113-140 (optional)
- Fasteners sufficient for mounting the units such as 5/16" diameter anchor/lag bolts
- 7/8" diameter washers
- Fasteners appropriate for the shelter wall construction to attach the controller to the wall
- Commercial grade outdoor silicone sealant
- Miscellaneous hand and power tools and jobsite or shop materials
- Lifting equipment with the necessary capacity and rigging to safely move/install the systems
- Water to prime drain traps
- Electrical supplies
 - Various size circuit breakers for the shelter AC breaker box (see Table 3 on page 18)
 - High-voltage wire of various gauges (see Table 3)
 - 16 gauge minimum, 14 gauge maximum power wire to connect controller to shelter power source
 - 5-wire, 18 gauge shielded cable for remote temperature and humidity sensors (2-wire, 18 gauge shielded cable for temperature-only sensors)
 - Communication wire: 2-wire, 18 gauge, shielded with drain
 - 18 gauge non-shielded wire for connecting smoke detector, hydrogen detector and/or generator, if applicable, to controller
 - CAT 6 Ethernet cable of field-determined length (for remote communication, if applicable)
 - 2 hole grounding lug (to be used with supplied 1/4" bolts and nuts for grounding controller box)
 - Miscellaneous electrical supplies including rigid/flexible conduit and fittings, 2" x 4" junction boxes (one per temperature/humidity sensor), wire connectors and supports

NOTICE

The following is required and must be sourced prior to installation of these units.

- **One (1) 5A circuit breaker for the shelter DC power plant (for the controller)**

Circuit breakers for Emerson Network Power (ENP) power plants (used in most telecomm shelters built today) are available directly through the following distributors:

- **Emerson Network Power: 440.288.1122**
- **Master Electronics: 888.473.5297 or www.onlinecomponents.com**

Emerson Network Power (ENP) Part Number

- **5A circuit breaker: P/N 101598**

Always confirm the application before ordering.

Model Identification

Identify the specific model using the model nomenclature information found in Figure 1 and the model/serial tag found on the unit. See Figure 2 on page 9 for dimensions and critical installation requirements.

New Shelter Installation vs. Retrofit Installation

These installation instructions cover both new shelter installations and retrofit installations. Each installation

is unique and may require special accommodations and modifications. Although Bard Manufacturing follows a long-established tradition of manufacturing equipment using industry standard dimensions for building penetration, it is occasionally necessary to move or enlarge supply and return openings when replacing non-standardized equipment in a retrofit application.

IMPORTANT: All retrofit installations require any existing supply and return grilles be removed and discarded. This is a counterflow unit and requires specified grilles to ensure proper system performance.

FIGURE 1
FUSION-TEC HR Series Wall-Mount Unit Model Nomenclature

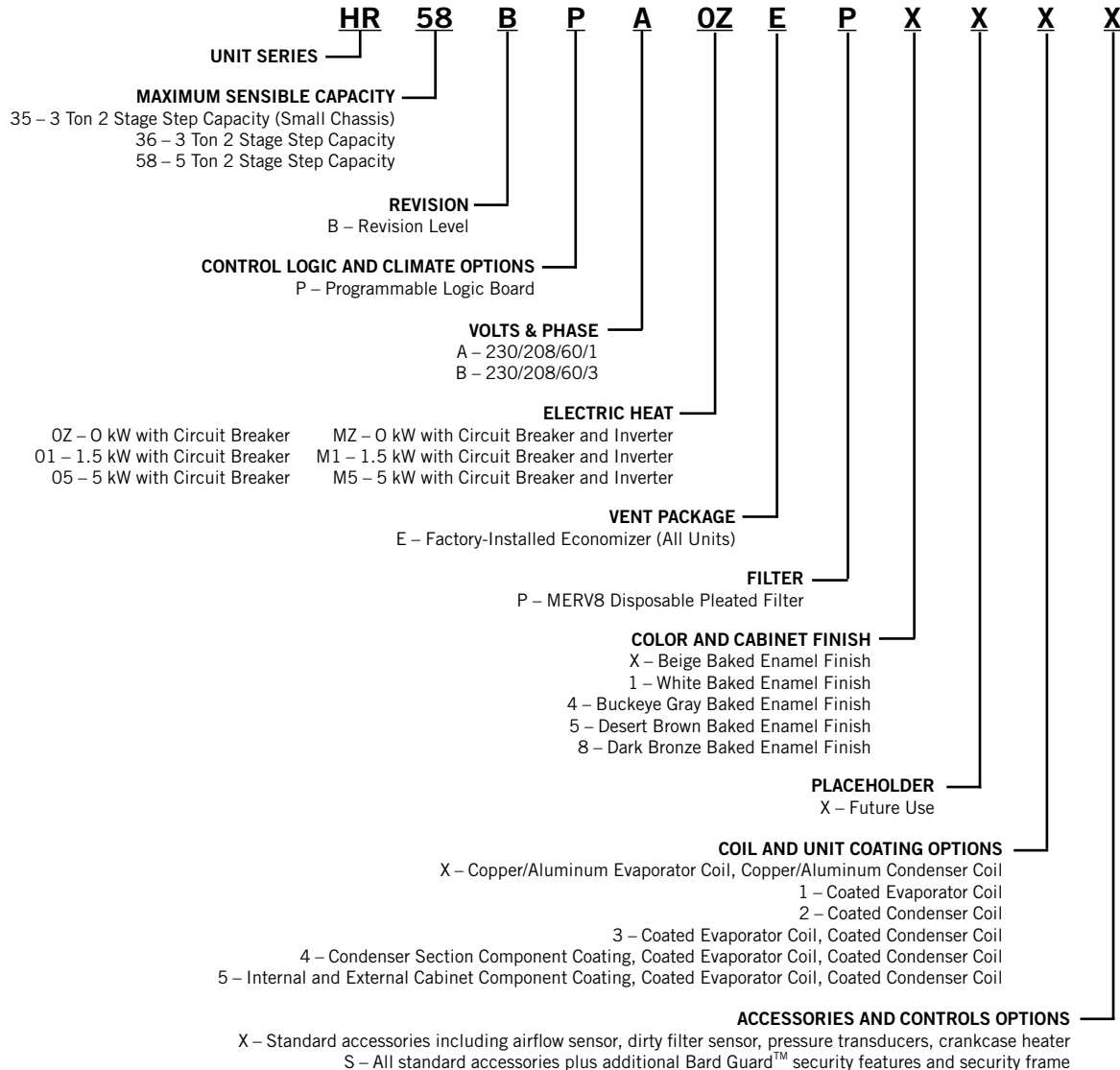

Minimum Clearance

Counter flow wall-mount air conditioner models have a removable lower front service panel that allows access to the control panel, blower, compressor, circuit breakers and heat strip. There is a hinged access panel on both sides for filter change and evaporator coil service.

The upper side panel is removable to allow access to condenser fan, condenser coil and filter drier. The design allows for installations to place units within close proximity without complicating maintenance and repair.

To maintain full serviceability, side-by-side installations require 15" of clearance between units.

The condenser discharge air exits through the top of the unit. Although this reduces the potential for recirculation, it is still critical to system performance that any obstruction, shrubbery or structure adhere to minimum clearances listed (see Table 1).

For overhangs not exceeding 12" from exterior wall, minimum allowable clearance from top of unit to bottom of overhang should be no less than 5". For overhangs greater than 12" from exterior wall, minimum allowable clearance from top of unit to bottom of overhang should be no less than 10".

Clearance to Combustibles

The unit itself is suitable for 0" clearance, but the supply air flange requires a minimum of 1/4" clearance to combustible material. However, it is generally recommended that a 1" clearance is used for ease of installation and maintaining the required clearance to combustible material. See Figure 8 on page 13 for details on opening sizes.

WARNING

Fire hazard.

Maintain minimum 1/4" clearance between the supply flange and combustible materials.

Failure to do so could result in fire causing damage, injury or death.

TABLE 1
Clearance Required for Service Access and Adequate Condenser Airflow

Model	Side(s)	Discharge (Top) Overhang 12" or less	Discharge (Top) Overhang Exceeding 12"	Intake (Base)	Front of Unit	Shelter Equipment from Supply Grille
HR35 HR36 HR58	15"	5"	10"	15" from Snowline	36"	24"

TABLE 2
Minimum Clearances Required to Combustible Materials

Model	Supply Air Flange	Cabinet
HR35 HR36 HR58	1/4"	0"

FIGURE 2

Dimensions of Basic Unit for Architectural and Installation Requirements (Nominal)

Model	Width (W)	Depth (D)	Height (H)	Return		Supply		G	I	J	K	L	M	N	O	P	Q	R
				A	B	C	B											
HR35	36.86	27.33	71.61	7.75	27.75	13.77	27.75	29.73	18.06	31.08	21.27	33.08	36.08	3.45	37.92	2.33	16.00	3.92
HR36	42.00	30.00	76.00	9.88	29.88	14.25	29.88	34.13	30.00	29.13	13.00	31.13	34.13	3.50	43.00	2.69	17.00	3.88

All dimensions are in inches. Dimensional drawings are not to scale.

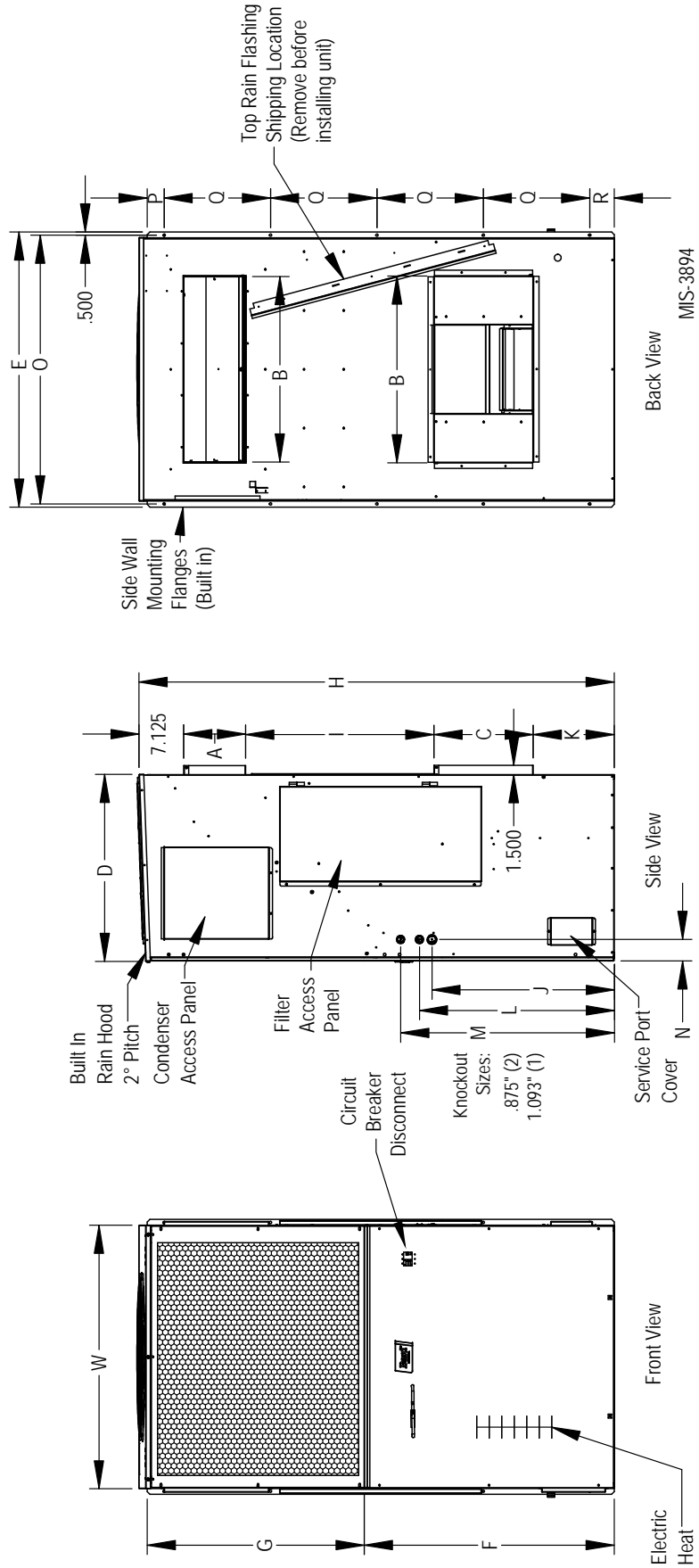

WALL-MOUNT UNIT MOUNTING

Mounting the Units

WARNING

Heavy item hazard.

Use more than one person to handle unit.

Failure to do so could result in unit damage or serious injury.

NOTE: *It may be best to spot some electrical knockouts (such as those located on the sides of the wall-mount unit) before units are mounted and access is unavailable or limited (see Figure 2 to locate pre-punched knockouts).*

Two holes for the supply and return air openings must be cut through the wall as shown in Figure 8 (page 13) and Figure 9 (page 14). On wood frame walls, the wall construction must be strong and rigid enough to carry the weight of the unit without transmitting any unit vibration. All walls must be thoroughly inspected to ensure that they are capable of carrying the weight of the installed unit.

In retrofit (unit replacement) installations, the openings cut for the original equipment may not line up exactly with needs of this installation. Modifications may need to be made, such as increasing or decreasing the size of the wall cutouts. The existing bolt placement may not line up in which case the original bolts would need to be removed or cut away.

These units are secured by full-length mounting flanges built into the cabinet on each side. An optional bottom mounting bracket (purchased separately) is available, but not required.

The unit itself is suitable for 0" clearance, but the supply air flange requires a minimum of 1/4" clearance to combustible material. However, it is generally recommended that a 1" clearance is used for ease of installation and maintaining the required clearance to combustible material. See Figures 8 and 9 for details on opening sizes.

IMPORTANT: *When removing the shipping pallet from beneath the wall unit, **do not** loosen or remove any of the screws from either side of the unit.*

1. Locate and mark lag bolt locations on both sides and location for optional bottom mounting bracket, if desired (see Figure 8 or 9).

NOTE: *Top rain flashing is attached to back of unit for shipping purposes. Be sure to remove this flashing before installing unit.*

2. If desired, hook top rain flashing under back bend of top.
3. Position unit in opening and secure with fasteners sufficient for the application such as 5/16" lag/anchor bolts; use 7/8" diameter flat washers on the lag bolts. It is recommended that a bead of commercial grade outdoor silicone sealant caulk be placed behind the side mounting flanges.

NOTE: *Opening and removing the filter access door from each side may make fastening unit to wall easier.*

4. Secure optional rain flashing to wall and caulk around entire unit (see Figure 8 or 9).
5. For additional mounting rigidity, the return air and supply air frames or collars can be drilled and screwed or welded to the structural wall itself (depending upon wall construction). Be sure to observe required clearance if combustible wall.
6. Four plastic drain hoses extend from the condenser and evaporator drain pans. The drain hoses are secured to fittings mounted to the unit base.

NOTE: *At the time of installation, Bard highly recommends prefilling of the traps on both of the indoor drain pan hoses to ensure proper unit drainage at start. The water traps can easily be seen with the front service panel removed. To fill traps, pour water into both sides of evaporator drain pan until the drain hoses are visibly full (see Figure 3).*

A unique feature of the FUSION-TEC is the ability to hang the front service panel on the unit in a position that allows full access to the control panel (see Figure 4) while the unit remains fully functional for troubleshooting and testing. To do this, remove the panel and hook top lip of panel into bottom channel of control panel. For added front panel stability, use several of the screws that were removed to temporarily connect the panel to the unit.

FIGURE 3
Prefilling Traps on Indoor Drain Pan Hoses



Evaporator Drain Pan Left Side Drain Hose



Evaporator Drain Pan Right Side Drain Hose

Pour water into evaporator drain pan directly above left and right drain fittings until coiled drain tubes in blower section are visibly full.

FIGURE 4
Hanging Front Access Panel to Allow Access to Control Panel



Supply Air Grill Installation

Bard model SGR-5W grille is custom designed for utilization with Bard wall-mount unit HR**AP* for optimizing the air flow pattern and distribution to minimize recirculation issues, and optimizing airflow patterns within the shelter. It is engineered to ensure that the distributed air is forced in a downward and outward direction to eliminate obstructions and such from causing the distributed air from stratifying close to the unit and getting drawn back into the return air opening. With the optimized air pattern, the shelter should experience distributed air at the opposite end of the room.

To accomplish this, the grille has two special features:

1. The grille has a specialty fold-out diverter on the backside of the grille that directs the supply airflow in an outward pattern, thereby eliminating the potential for the obstruction of supply air if

FIGURE 5
Fold-Out Diverter



Rear deflector as shipped



Rear deflector raised and secured together

equipment would be directly mounted in front of the unit. The rear deflector must be folded out and secured by the installer with the supplied screws (see Figure 5).

2. The grille is also equipped with downward curved diverter blades to ensure a smooth and efficient means of directing the air pattern in a downward pattern, and away from being drawn back into the return air opening. The curved diverter blades are shipped in the flat position and need to be folded out to between 75-90° (best tuned to each individual structure). See Figures 6 and 7.

FIGURE 6
Downward Curved Diverter Blades



Diverter blades as shipped (left), and after raising (right)

FIGURE 7
View of Installed Grille (as seen from above)



FIGURE 8
HR35 Mounting Instructions

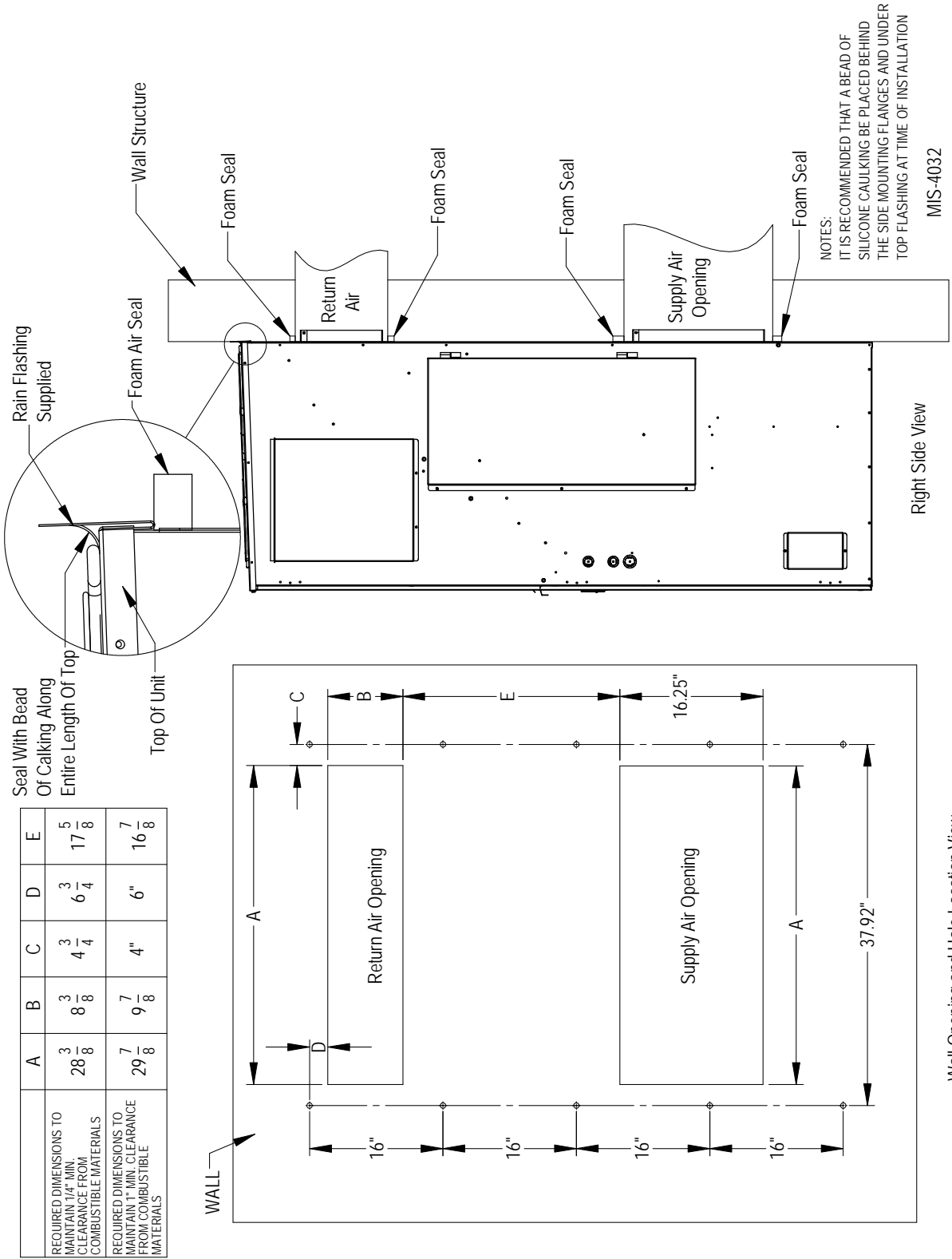
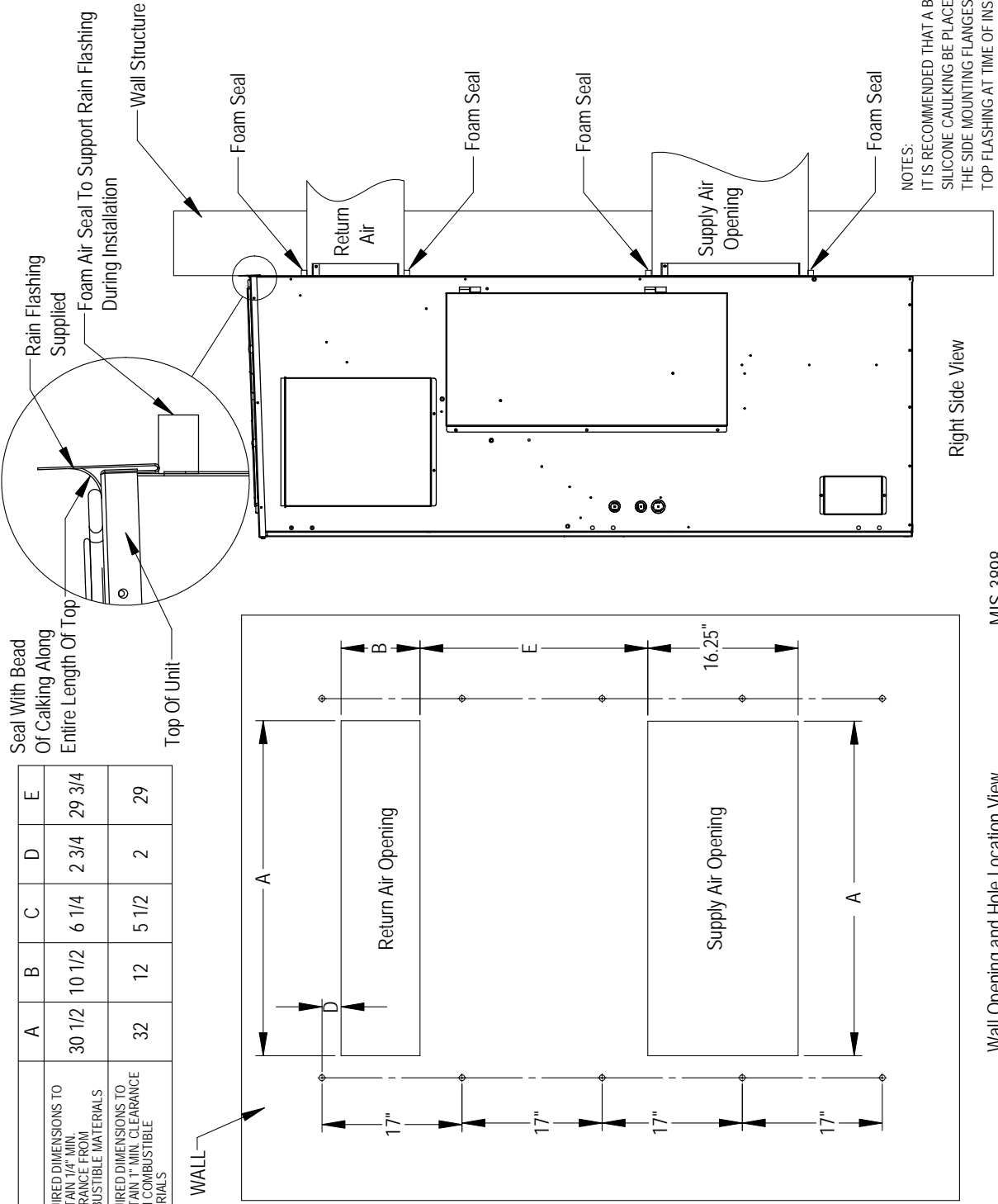

FIGURE 9
HR36/HR58 Mounting Instructions

REQUIRED DIMENSIONS TO MAINTAIN 1/4" MIN. CLEARANCE FROM COMBUSTIBLE MATERIALS	A	B	C	D	E
	30 1/2	10 1/2	6 1/4	2 3/4	29 3/4
REQUIRED DIMENSIONS TO MAINTAIN 1" MIN. CLEARANCE FROM COMBUSTIBLE MATERIALS	32	12	5 1/2	2	29



NOTES:
IT IS RECOMMENDED THAT A BEAD OF SILICONE CAULKING BE PLACED BEHIND THE SIDE MOUNTING FLANGES AND UNDER TOP FLASHING AT TIME OF INSTALLATION

MIS-3898

Wall Opening and Hole Location View

FIGURE 10
Electric Heat Clearance

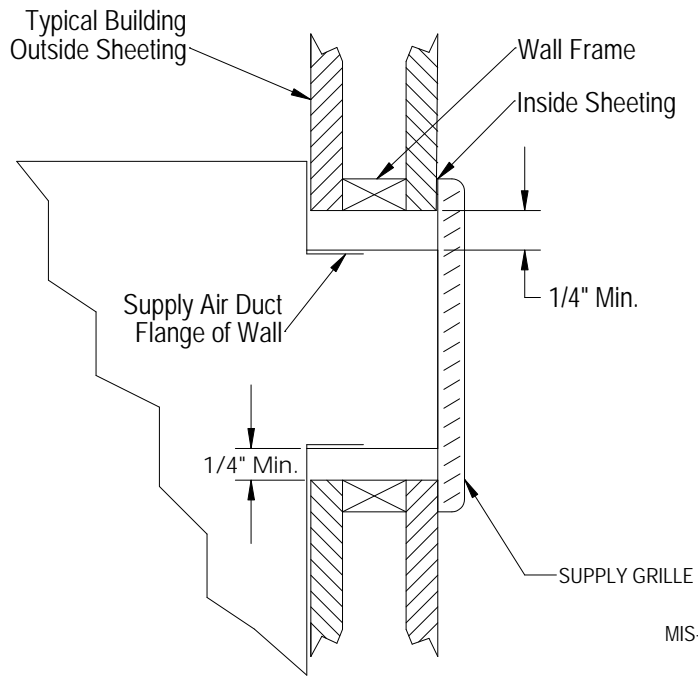

FIGURE 11
Wall Mounting Instructions

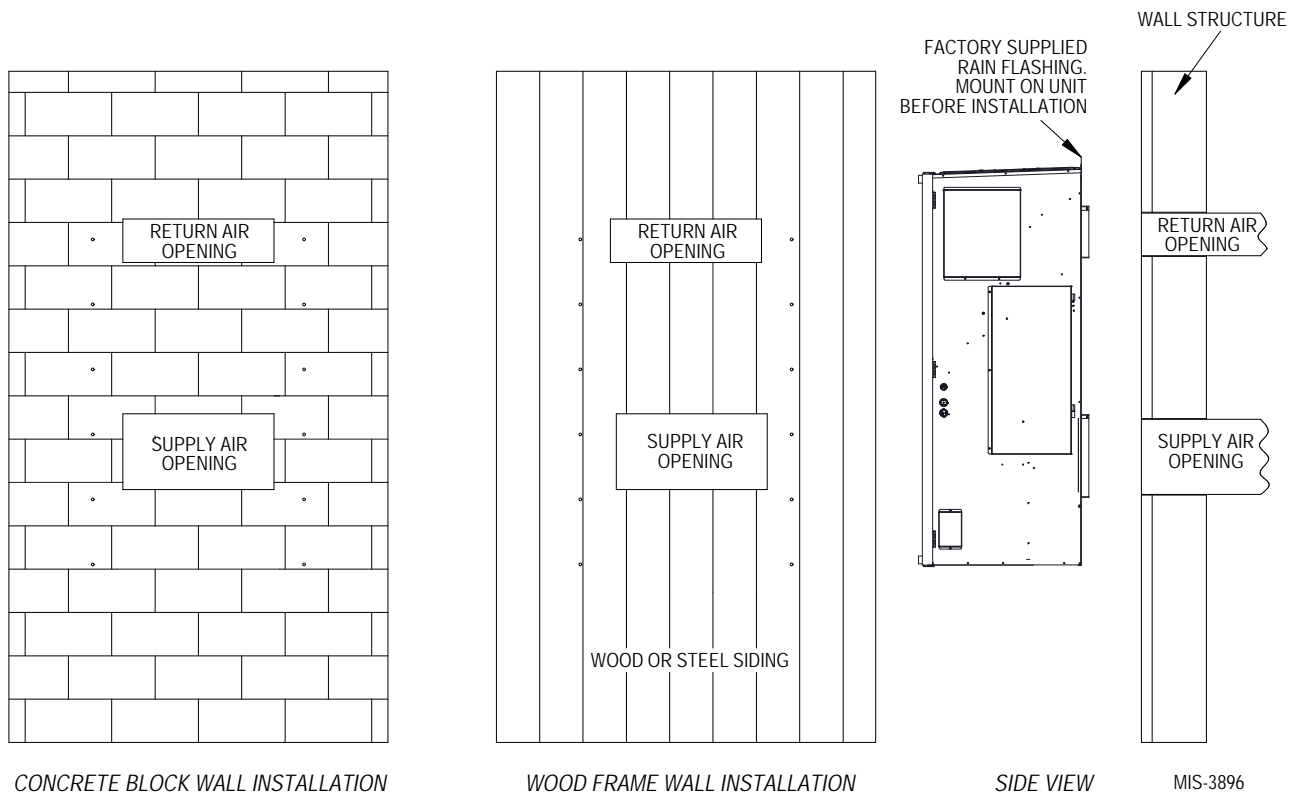
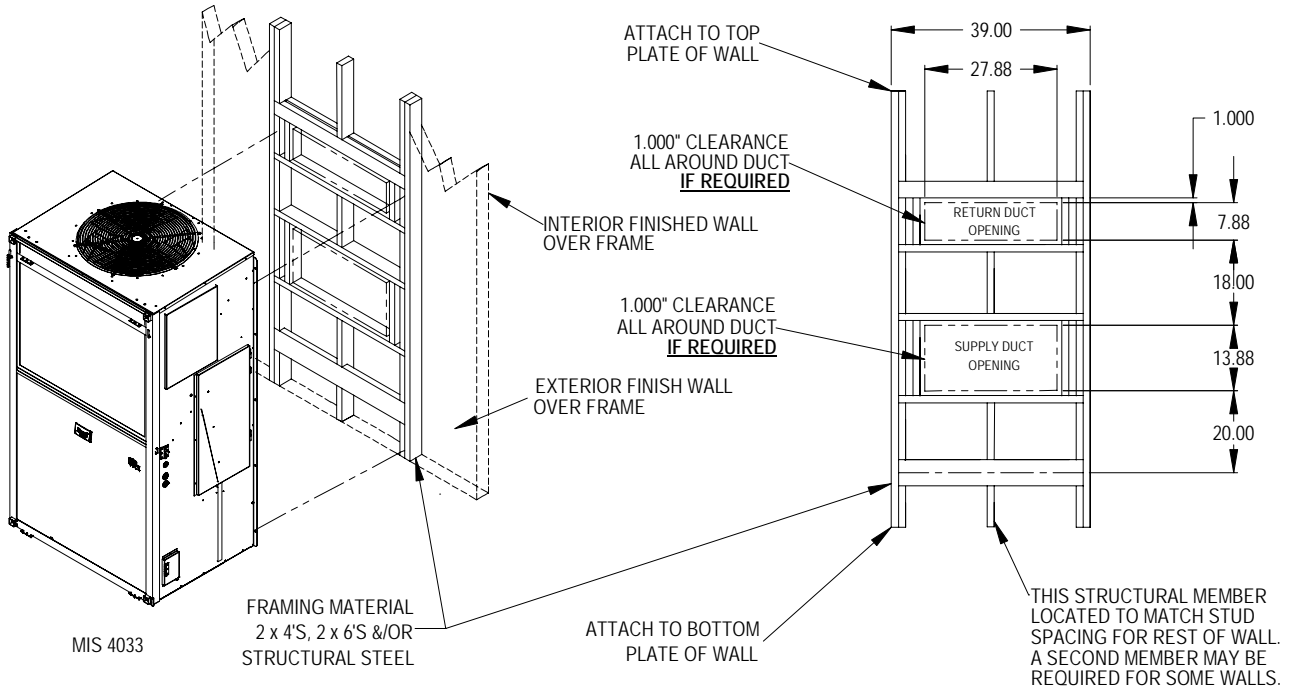

FIGURE 12 Wall Mounting Instructions

HR35 Models



HR36/HR58 Models

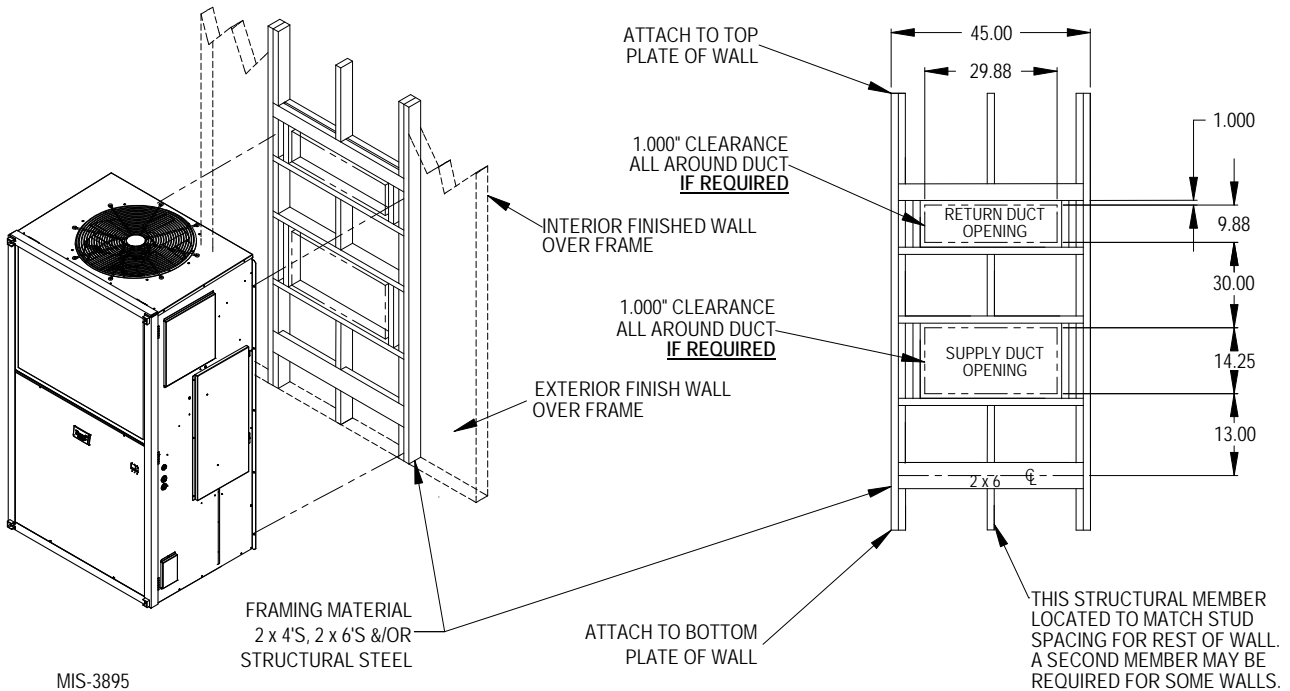
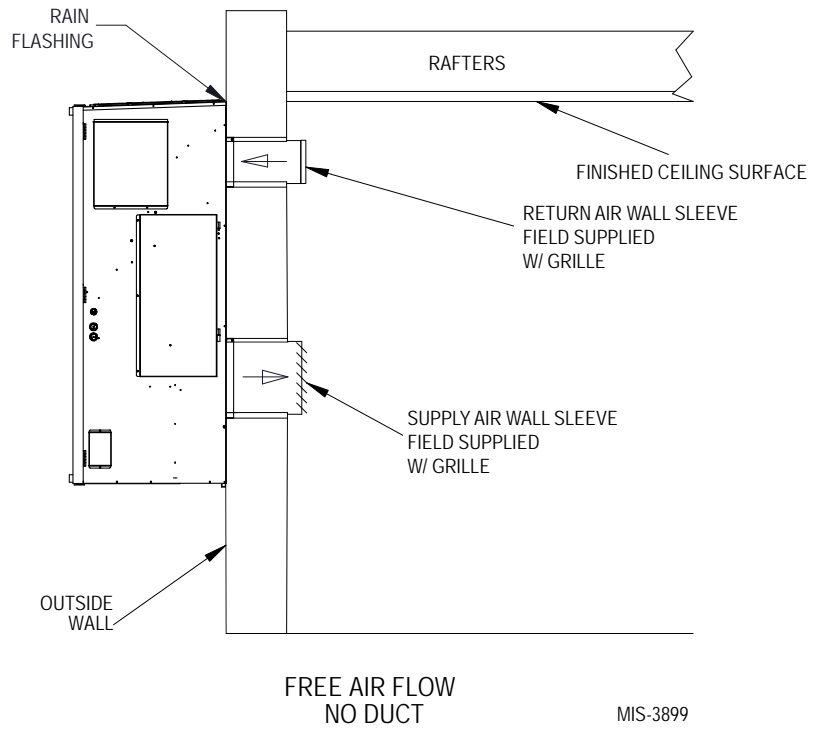

FIGURE 13
Common Wall Mounting Installation



WALL-MOUNT UNIT WIRING

WARNING

Electrical shock hazard.

Have a properly trained individual perform these tasks.

Failure to do so could result in electric shock or death.

Main Power Wiring

Refer to the unit rating plate or Table 3 for wire sizing information and maximum fuse or circuit breaker size. Each outdoor unit is marked with a “Minimum Circuit Ampacity”. The field wiring used must be sized to carry that amount of current. Depending on the installed KW of electric heat, there may be two field power circuits

required. If this is the case, the unit rating plate will so indicate. All models are suitable only for connection with copper wire. Each unit and/or wiring diagram will be marked “Use Copper Conductors Only”. These instructions **must be** adhered to. Refer to the National Electrical Code (NEC) for complete current carrying capacity data on the various insulation grades of wiring material. All wiring must conform to NEC and all local codes.

The unit rating plate and Table 3 list fuse and wire sizes (75°C copper) for all models including the most commonly used heater sizes. Also shown are the number of field power circuits required for the various models with heaters.

The unit rating plate lists a maximum circuit breaker or fuse that is to be used with the equipment. The correct size must be used for proper circuit protection and also to ensure that there will be no nuisance tripping due to the momentary high starting current of the compressor motor.

TABLE 3
Electrical Specifications

Model	Rated Volts & Phase	No. Field Power Circuits	Single Circuit			
			③ Minimum Circuit Ampacity	① Maximum External Fuse or Circuit Breaker	② Field Power Wire Size	② Ground Wire
HR35 A0Z, AMZ A01, AM1 A05, AM5	230/208-1	1	26	35	8	10
		1	26	35	8	10
		1	30	35	8	10
HR35 B0Z B05	230/208-3	1	25	30	10	10
		1	25	30	10	10
HR36 A0Z, AMZ A01, AM1 A05, AM5	230/208-1	1	26	35	8	10
		1	26	35	8	10
		1	30	35	8	10
HR36 B0Z B05	230/208-3	1	25	30	10	10
		1	25	30	10	10
HR58 A0Z, AMZ A01, AM1 A05, AM5	230/208-1	1	43	60	8	10
		1	43	60	8	10
		1	43	60	8	10
HR58 B0Z B05	230/208-3	1	30	45	8	10
		1	30	45	8	10

① Maximum size of the time delay fuse or circuit breaker for protection of field wiring conductors.

② Based on 75°C copper wire. All wiring must conform to the National Electrical Code and all local codes.

③ These “Minimum Circuit Ampacity” values are to be used for sizing the field power conductors. Refer to the National Electrical code (latest version), Article 310 for power conductor sizing.

CAUTION: When more than one field power circuit is run through one conduit, the conductors must be derated. Pay special attention to Note 8 of Table 310 regarding Ampacity Adjustment Factors when more than three current carrying conductors are in a raceway.

IMPORTANT: While this electrical data is presented as a guide, it is important to electrically connect properly sized fuses and conductor wires in accordance with the National Electrical Code and all local codes.

The main unit circuit breaker disconnect access is located on the front panel of the unit. Located at the upper right corner of this panel is the rubber circuit breaker boot. This allows unit power to be disconnected without panel removal.

Route all field power wires in channel under the control panel as shown in Figure 14. See Figure 15 to reference VAC landing points.

FIGURE 14
Wire Routing



FIGURE 15
VAC Supply Wiring Landing Points

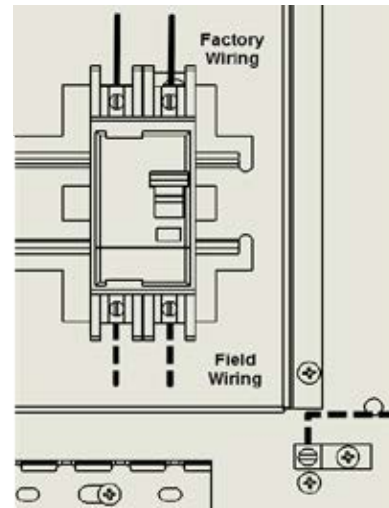

Route wires into unit through recommended side entrances (see Figure 16). Optional rear entry points are also available (see Figure 17 on page 20).

When running wires to unit from shelter, be careful to not place wiring and conduit where it will interfere with opening filter access doors.

FIGURE 16
Side Communication and Power Wire Entrances (Recommended)

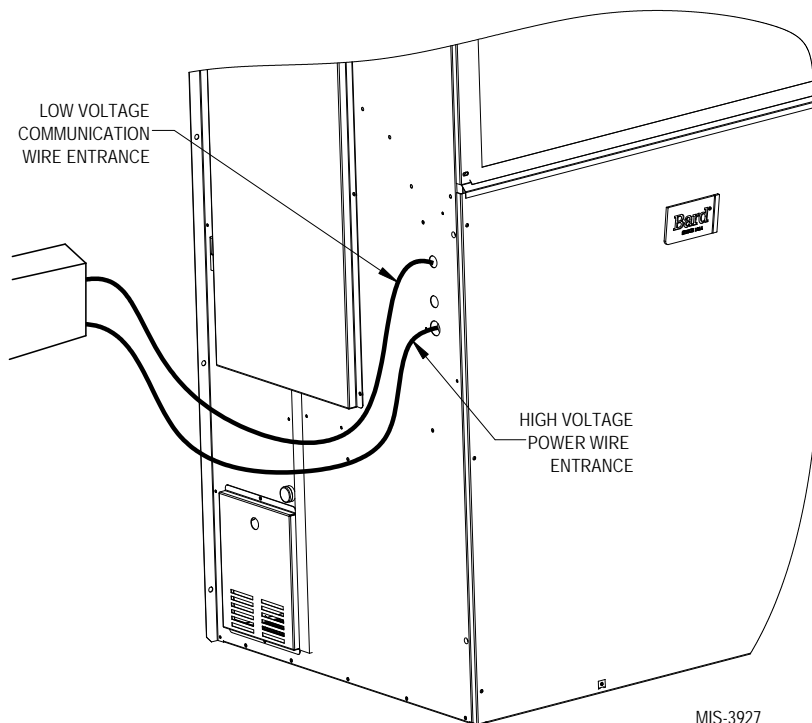
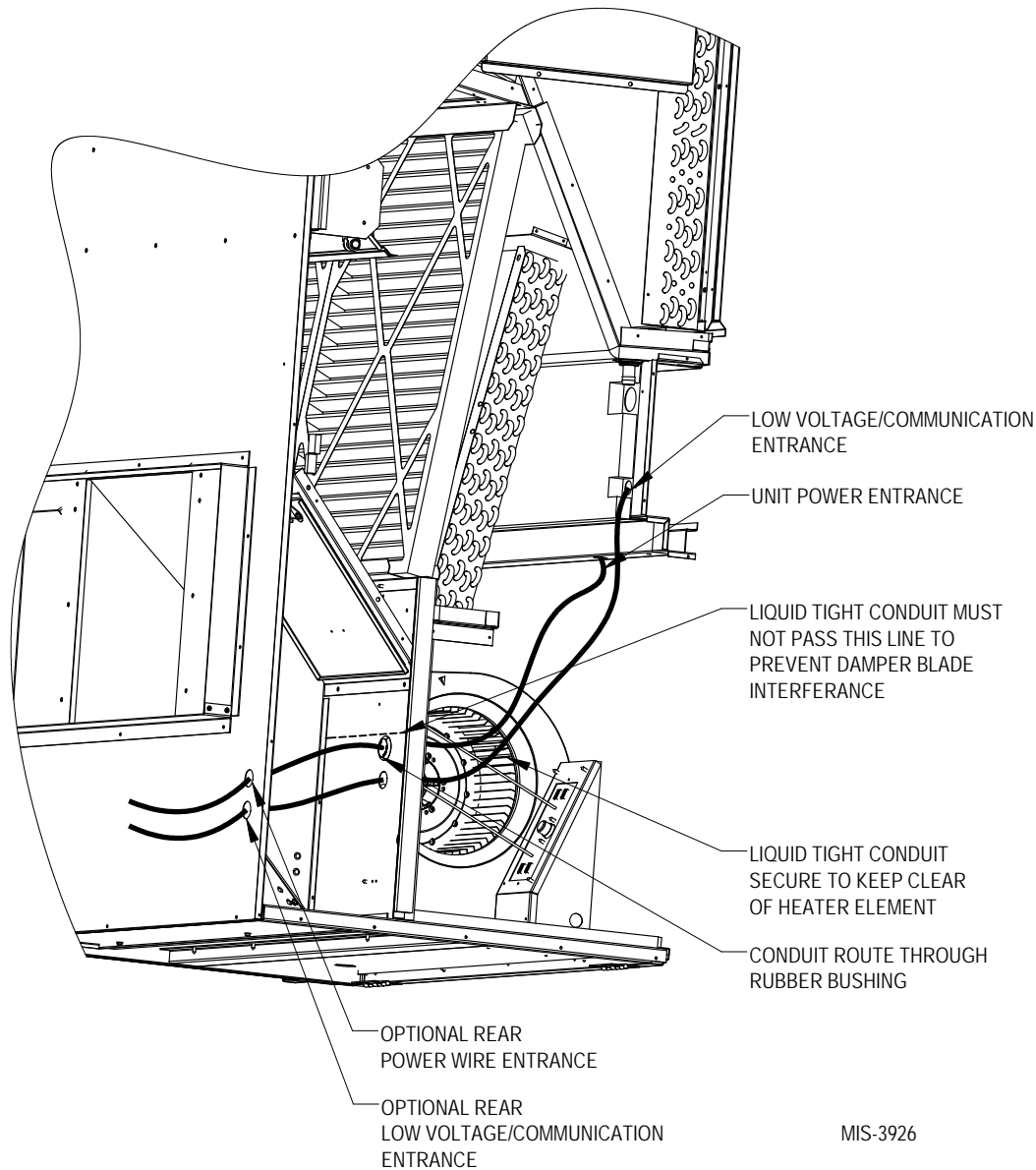

FIGURE 17
Rear Communication and Power Wire Entrances (Optional)



MIS-3926

Unit Control Voltage Wiring

230/208V 1 phase and 3 phase equipment use dual primary voltage transformers. All equipment leaves the factory wired on 240V tap. **It is very important that the correct voltage tap is used.** For 208V operation, reconnect from 240V to 208V tap. The acceptable operating voltage range for the 240 and 208V taps are: 240V tap (253 – 216) and 208 tap (220 – 197). To verify voltage and adjust voltage tap (if necessary), see Figure 18.

NOTE: *The voltage should be measured at the field power connection point in the unit and while the unit is operating at full load (maximum amperage operating condition).*

FIGURE 18
Adjusting the 230/208 VAC Transformer

230/208V 1 phase and 3 phase equipment use dual primary voltage transformers. All equipment leaves the factory wired on 240V tap. **It is very important that the correct voltage tap is used.** For 208V operation, reconnect from 240V to 208V tap. The acceptable operating voltage range for the 240 and 208V taps are: 240V Tap (253 – 216) and 208V Tap (220 – 197).

1. Verify incoming AC voltage: Multimeter set to VAC

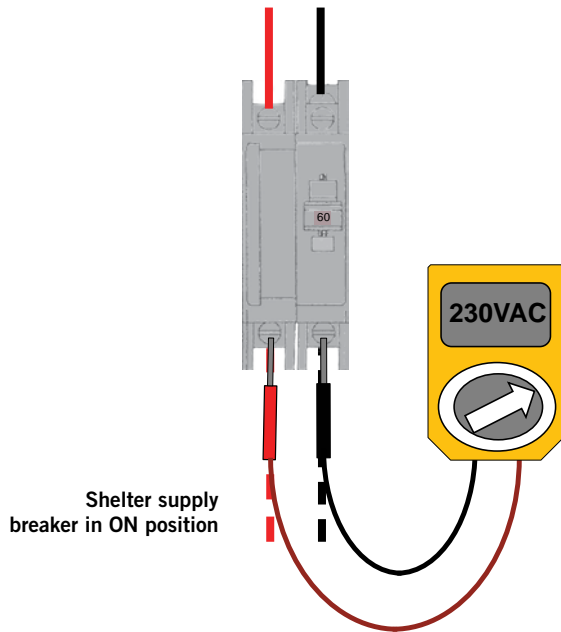

230V/208V Single Phase Voltage Range:
197VAC – 253VAC

230V/208V Three Phase Voltage Range:
197VAC – 253VAC
 (not shown)

2. If incoming AC voltage is 220VAC or above...

...do not adjust transformer

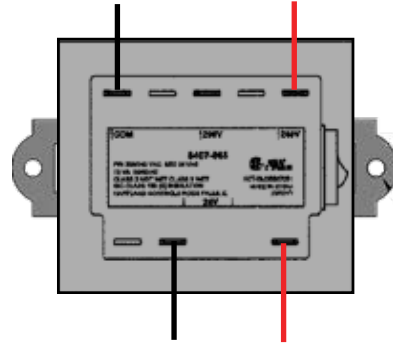

3. If incoming AC voltage is below 220VAC...

...shut off AC breaker to unit
 and move factory "240V" wire to "208V" terminal

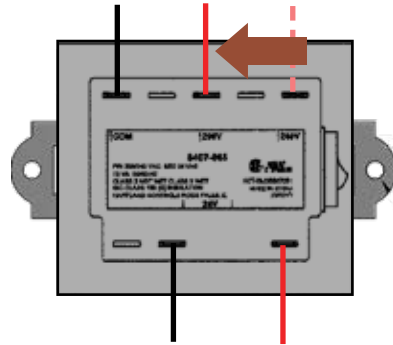

Software Update

Once power is applied to the installed wall unit and/or supervisory controller, Bard advises that the software should be updated to the latest version. Visit the Bard software download page for the latest software. Then, check the versioning of each software; see the steps below for each device.

Software Info

The software information screens display all program version information for the PLC (see **Software Versioning Guide**). This screen also displays the PLC operating system version and processor core type. The processor core type is needed when deciding what software update package to download for the controller. If the OS Version line is blank after the numerical version numbers, or has a “Core 0” identifier after the numerical version numbers, then the PLC requires an update package that does not have a `_core#` suffix or has the `_core0` suffix in the software update package. If the OS Version line has a “Core 2” identifier after the numerical version numbers, then the PLC requires an update package that has the `_core2` suffix in the software update package.

Software update packages can be found at <http://bardhvac.com/software-download/>

For more information on the software updating process, please refer to the 7960-798 LV1000, FUSION-TEC HR Series Software Update Manual (included with any software update download package).

FUSION-TEC Software Information

1. Connect the TEC-EYE diagnostic tool to the control board located in the unit.
2. From the Main screen, press UP or DOWN button until Quick Menu displays the “I” icon. Press ENTER button.
3. Press UP or DOWN button until the software version screen is displayed (see Figure 19).

FIGURE 19
FUSION-TEC HR Series Software Info

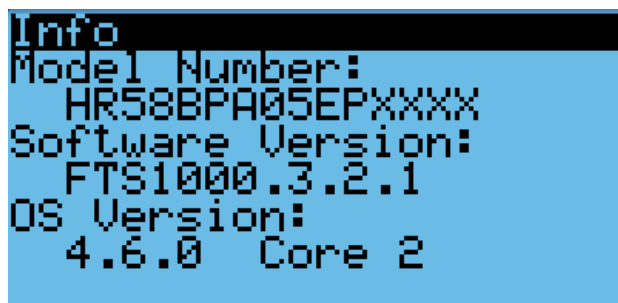

LV1000 Software Information

1. From the Main screen, press UP or DOWN button until Quick Menu displays the “I” icon. Press ENTER button.
2. Press UP or DOWN button until the cursor highlights the System Info Menu. Press the ENTER button.
3. Press UP or DOWN button until the software version screen is displayed (see Figure 20).

FIGURE 20
LV1000 Software Info



Software Versioning Guide

LVS1000.X.Y.Z_Core#

Software Name: The name of the software is the base part number used to identify which product the software is used in.

TABLE 4
Software Versioning Guide

Product	Software Name
LV1000	LVS1000
FUSION-TEC (HR)	FTS1000

- X The letter X represents a major change to the software effecting product compatibility or function of the equipment.
- Y The letter Y represents a minor change to the software that either adds, removes, or alters a feature of the equipment without effecting compatibility with other products.
- Z The letter Z represents a change to the software that fixes existing features or user interface.

Core: This identifier is only shown in the software download package. It identifies the processor core type of the PLC and can only be used in a PLC with the corresponding processor core type. (See **Software Info** above for more information on how to identify processor core type.)

Running in Orphan Mode

FUSION-TEC HR Series wall-mount units have the capability to run without the LV1000 controller attached—this feature is called orphan mode. This keeps the shelter between 45°F and 79°F (factory default settings) by the use of the factory-installed return air sensor in each wall-mount unit. In orphan mode, no auxiliary temperature measurement devices are required for operation. The wall-mount unit automatically uses a continuous blower setting to circulate room air into the return air inlet and uses the return air temperature sensor to control room temperature.

To verify or change the wall-mount unit cooling and heating setpoints in orphan mode:

1. Connect the TEC-EYE diagnostic tool to the control board located in the unit.
2. From the Status screen, press UP or DOWN key until Quick Menu displays Setpoints icon (). Press ENTER key.
3. Press ENTER key to scroll to the selected choice (see Figure 21).
4. Press UP or DOWN key on desired setpoint until desired value is displayed.
5. Press ENTER key to save and scroll to next parameter.
6. Press ESCAPE key until Main Menu screen is displayed.

During installation, the ability to run in orphan mode allows deactivation of one of the existing, older wall-mount units, while keeping the shelter cool with the other unit still operating. Once the first of the Bard FUSION-TEC HR Series wall-mount units is installed and powered on, it will operate in orphan mode—keeping the climate inside the shelter stable and the installers comfortable while the remainder of the older equipment is removed and the remaining Bard FUSION-TEC HR Series wall-mount units and LV1000 controller are installed.

Additionally, should any or all of the FUSION-TEC HR Series wall-mount units lose communication with the LV1000 controller (such as during maintenance), they will continue to serve the shelter's needs until a repair can be made.

FIGURE 21
Cool and Heat Setpoints



LV1000 CONTROLLER INSTALLATION

FIGURE 22
Typical LV1000 Component Location

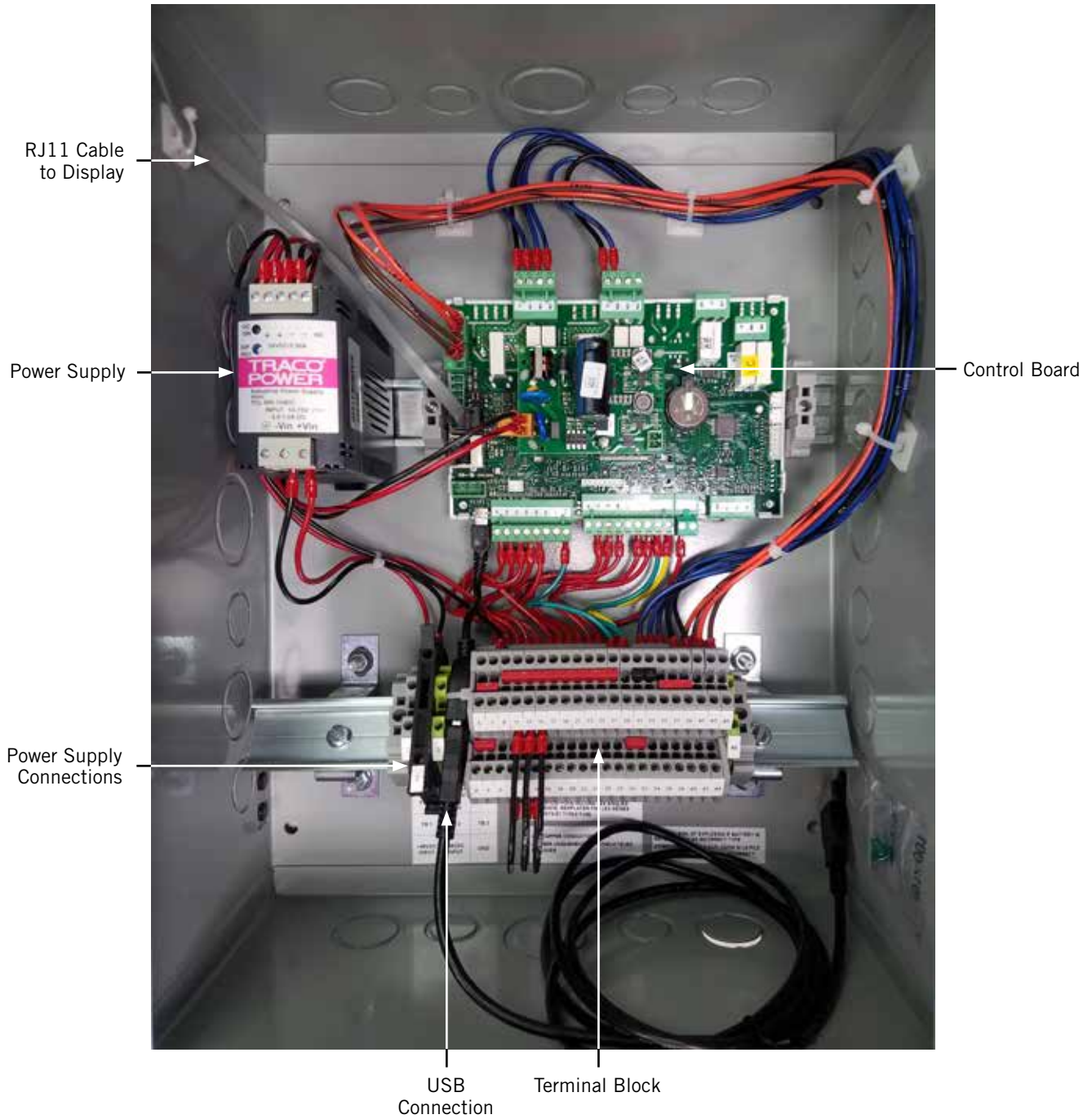

WARNING

Electrical shock hazard.

Disconnect VAC and VDC power supplies before servicing.

Failure to do so could result in electric shock or death.

IMPORTANT: *When working with circuit board components, Bard recommends the use of an anti-static wrist strap to prevent static electricity shorts to electronic controls.*

LV1000 Controller

The LV1000 controller is part of this Bard air conditioning system. It is used to control up to four (4) wall-mount air conditioners from one controller. The microprocessor control provides an easy-to-read interface with large LCD graphical display. It provides control for redundancy for the structure and equal wear on all units. The LV1000 controller is configured for first on/next on sequence.

Conduit is recommended for all wiring. Route communication wiring and power supply wiring in their own separate conduits.

The LV1000 controller is not weatherproof and is intended for use in weathertight structure.

Mounting the LV1000 Controller

The dimensions of the LV controller are 16" by 12" by 6".

Because the LV1000 controller utilizes a remote temperature sensor as opposed to one located in the controller box, the controller itself can be installed in any indoor location that is suitable, preferably at eye level. Four (4) mounting holes are provided for mounting to the wall and holes for conduit connection are provided in the base, sides and top of the controller.

Ground case before doing any work or do not connect power (48VDC) to unit until earth ground is connected.

The LV1000 controller includes a fused power supply terminal in the terminal block. Before connecting wires to the terminal block, confirm that the fuse in the fuse holder is in the proper position (active) as shown in Figure 23.

FIGURE 23
LV1000 Fused Power Supply Terminal

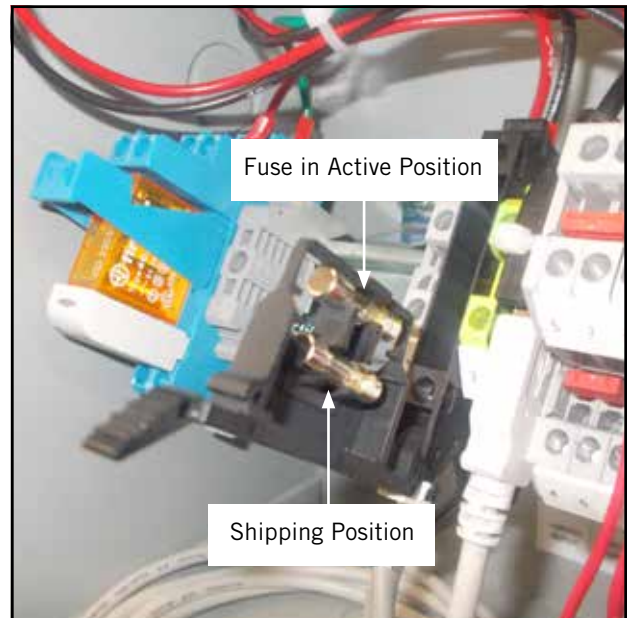

Installing Remote Indoor Temperature/Humidity Sensor(s)

One remote indoor temperature/humidity sensor and 35' of 18 gauge 5-conductor shielded cable is included with the controller. This sensor must be installed for proper operation. Mount the temperature/humidity sensor in a location least likely to be affected by open doors, rack-mounted fans, radiant heat sources, etc. Location height should be approximately 60" above the floor. The sensor should be installed on a 2" x 4" junction box to allow for control wire conduit (see Figure 24). Use shielded cable to connect to controller. The maximum cable length to connect the temperature/humidity sensor to the LV1000 is 98'.

FIGURE 24
Remote Indoor Temperature/Humidity Sensor Installation

1. Connect wires from the 18 gauge shielded cable to LV1000 terminals #24, #25, #18, #19 and #30.

LV1000 TB#	Sensor	Description	Wire Mark
24	NTC OUT	Indoor Temperature 1	B6
25	NTC OUT	Ground	GND
18	OUT H	Indoor Humidity 1 Signal: 0-1 VDC	B2
19	M (G)	Indoor Humidity 1 Common	GND
30	+ (G)	Indoor Humidity 1 Power	+VDC

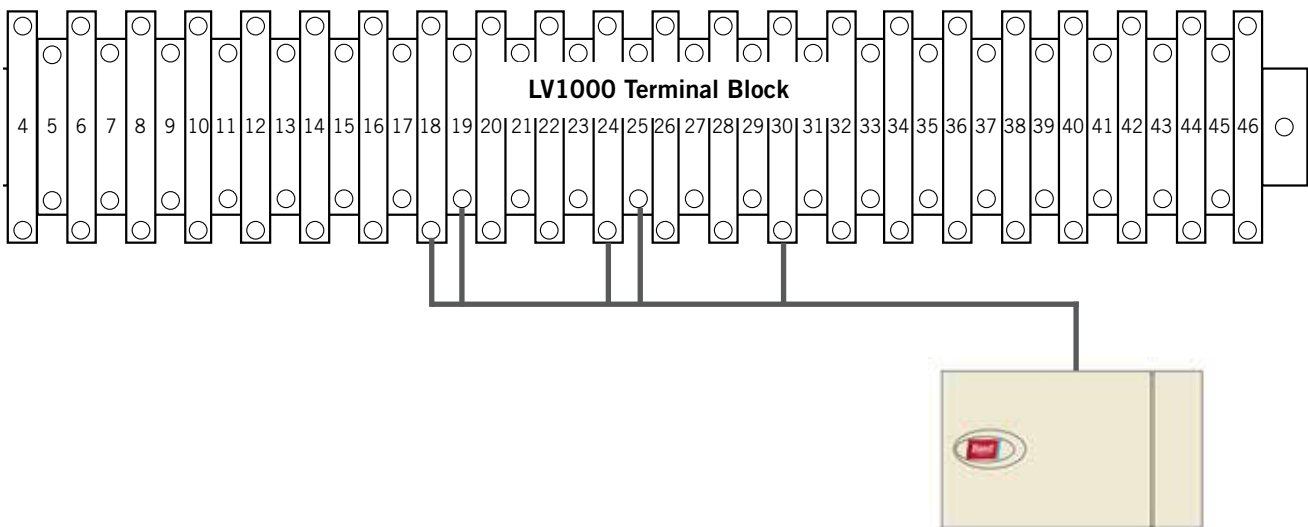

2. Connect the other end of the shielded cable to the sensor terminals. Be sure wires are connected to proper terminals as shown in table above.

Sensor jumpers need to be positioned for 0-1 V. With sensor oriented as shown in image to right, move both jumpers to right position (DP1 and DP2 set to OFF). **This applies to all indoor temperature/humidity sensors connected to the LV controller.** See illustration mounted inside of sensor cover for further detail on jumper position.

Earlier versions of this sensor may be mounted in a different orientation which would affect the positioning of the sensor jumpers. See page 49 for additional information on sensor orientation.

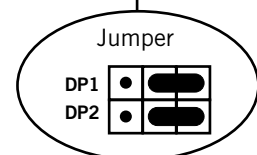
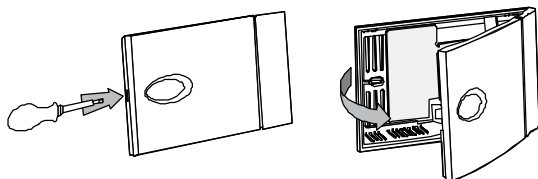

Up to two additional temperature and humidity sensors can be purchased and installed. Alternately, temperature-only sensors can be purchased and installed instead of the combination sensors. Use shielded cable to connect additional sensors to controller.

FIGURE 25
Additional Remote Temperature and Temperature/Humidity Sensor Installation

Up to two additional temperature/humidity sensors may be added. **Be sure the sensors are connected to the proper terminals on the terminal block and sensor as listed below.** See page 26 for information on correct sensor jumper position. The maximum cable length to connect temperature or temperature/humidity sensors to the LV1000 is 98'.

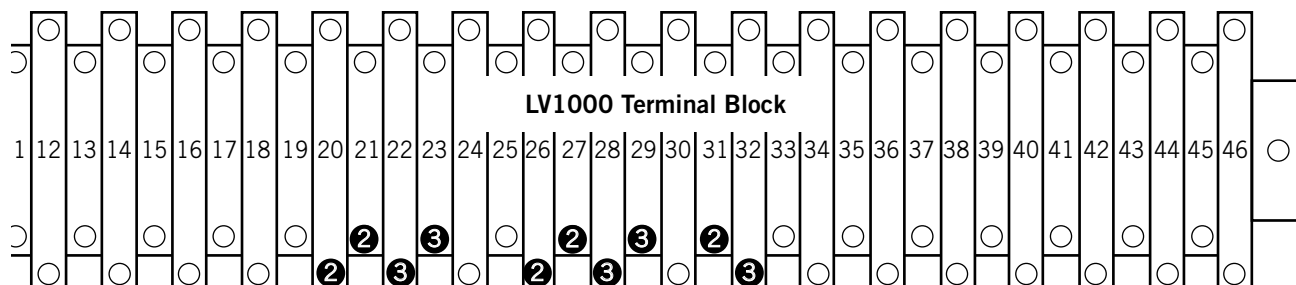

2
Optional Remote Temperature/Humidity Sensor
Terminals 26, 27, 20, 21 & 31

LV1000 TB#	Sensor	Description	Wire Mark
26	NTC OUT	Indoor Temperature 2	B7
27	NTC OUT	Ground	GND
20	OUT H	Indoor Humidity 2 Signal: 0-1 VDC	B3
21	M (G)	Indoor Humidity 2 Common	GND
31	+ (G)	Indoor Humidity 2 Power	+VDC

3
Optional Remote Temperature/Humidity Sensor
Terminals 28, 29, 22, 23 & 32

LV1000 TB#	Sensor	Description	Wire Mark
28	NTC OUT	Indoor Temperature 3	B8
29	NTC OUT	Ground	GND
22	OUT H	Indoor Humidity 3 Signal: 0-1 VDC	B4
23	M (G)	Indoor Humidity 3 Common	GND
32	+ (G)	Indoor Humidity 3 Power	+VDC

Temperature-only sensors can be used in place of the additional temperature/humidity sensors. #2 temperature-only sensor will connect to TB# 26 and 27. #3 temperature-only sensor will connect to TB# 28 and 29. The wire connections for the temperature-only sensors are not polarity sensitive.

Additional LV1000 Connections

There are factory-installed jumpers across terminals #10 and #11 (hydrogen detector), #12 and #13 (generator run) and #14 and #15 (anti-theft device). Remove the factory-installed jumpers before connecting to the hydrogen detector, generator and/or anti-theft device (if applicable).

INPUTS				
	LV1000 Connections		Sensor Connections	Description
	Wire Mark	Terminal	Terminal	
Smoke	DI1	8	Varies	Smoke Detector Input
	GND	9		Ground
Hydrogen	DI2	10		Hydrogen Detector Input
	GND	11		Ground
Generator	DI3	12		Generator Run Input
	GND	13		Ground
Anti-Theft	DI4	14	9 (BG1000)	Anti-Theft Device
	GND	15	10 (BG1000)	Ground

OUTPUTS				
	LV1000 Connections		External Connections	Description
	Wire Mark	Terminal	Terminal	
Humidifier	NO1	34	Varies	Humidifier Output
	C1	35		Common
HVAC Fail	NO2	36		Alarm Relay – HVAC Fail
	C1	37		Common
HVAC Maintenance	NO3	38		Alarm Relay – HVAC Maintenance
	C1	39		Common
Anti-Theft	NO4	40	Alarm Relay – Anti-Theft	
	C2	41	Common	

COMMUNICATIONS				
	LV1000 Connections		External Connections	Description
	Wire Mark	Terminal	Terminal	
Fieldbus 1*	FB-1 (-)	42	2	Wall Unit Daisy Chain
	FB-1 (+)	43	1	Wall Unit Daisy Chain
Fieldbus 2*	FB-2 (-)	44	-	-
	FB-2 (+)	45	+	-
Ground	FB-2 (-)	46	Drain	Drain for Daisy Chain

* Polarity Sensitive

Communication Wiring

Connect the communication wiring from the wall-mount units to the controller in the manner shown in Figures 26, 27 or 28. **The daisy chain does not need to follow the addressing order.** The communication wire should be 2-wire, 18 gauge shielded cable with drain. Any color can be used. Be sure to match "+" and "-" symbols on controller terminal blocks to prewired unit control terminal block (see Figures 30 and 31 on pages 32 and 33). Attach communication wire filters as shown in Figures 26, 27 or 28. Filters go inside the unit or controller box; they are shown out of unit for identification purposes only. **Do not run communication wiring in same conduit as supply wiring. Route communication wiring and power supply wiring in their own separate conduits.**

FIGURE 26
Communication Wiring (Daisy Chain Method)

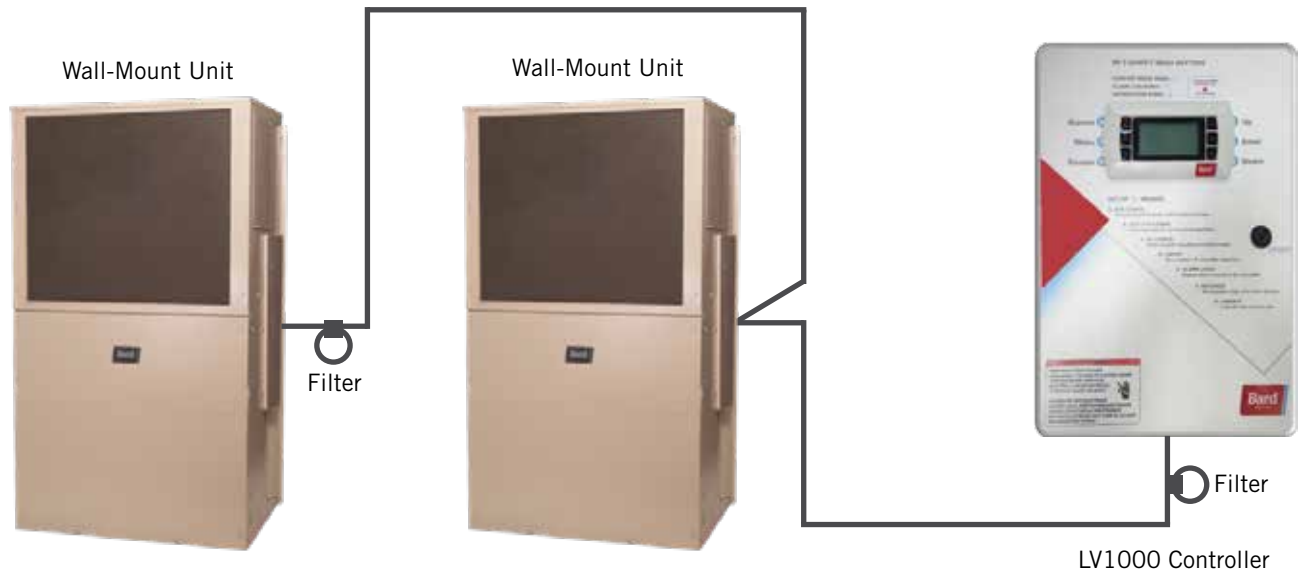

In addition to the "daisy chain" method of connecting the communication wiring shown in Figure 26, the wall-mount units can also be connected in the manner shown in Figure 27. If connecting wall units this way, be sure to place the communication wire filters in the positions shown in Figure 27. See Figure 28 on page 30 for more information on the correct placement of the communication wire filters depending on the wiring method used.

FIGURE 27
Communication Wiring (Alternate Method)

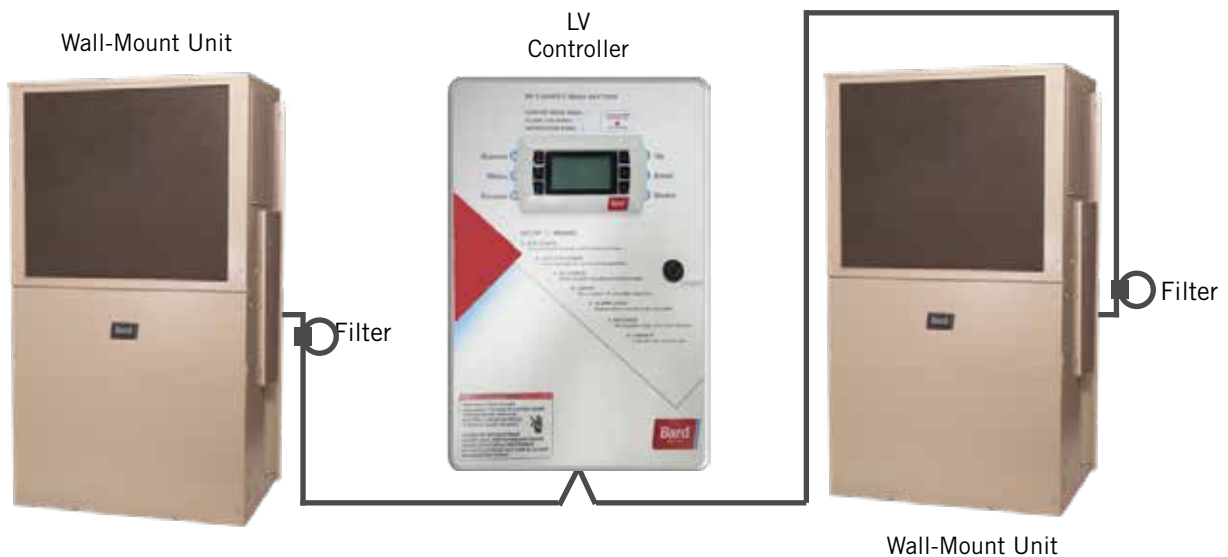
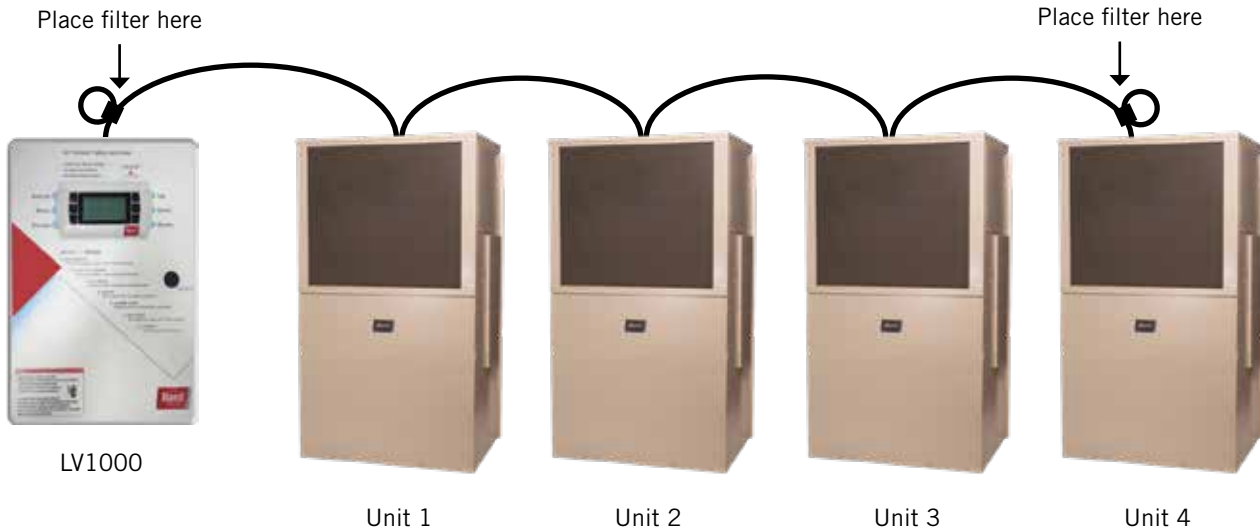

FIGURE 28
Placement of Communication Wire Filters (Daisy Chain and Alternate Methods)

Daisy Chain Wiring (up to four units)



Alternate Wiring (up to four units)



NOTE: Line filters can be on either the unit or controller, whichever device is on the end of the chain. No matter how many units there are, the two end devices will only have ONE communication cable, whereas the center devices will all have TWO (as shown above). Filters go inside the unit or controller; shown out of unit above for identification only.

The steps outlined on the following pages show how to connect the communication wiring using the daisy chain method shown in Figure 26. If using the alternate method (as shown in Figure 27), the connections to the controller and each wall-mount unit will be the same but the filters need to be placed in the positions shown in Figure 28.

FIGURE 29
Communication Wiring: Termination at the Controller

1. Using the field-provided shielded cable, make a small service loop after entering the controller and attach the provided EMI filter at the intersection of the loop.

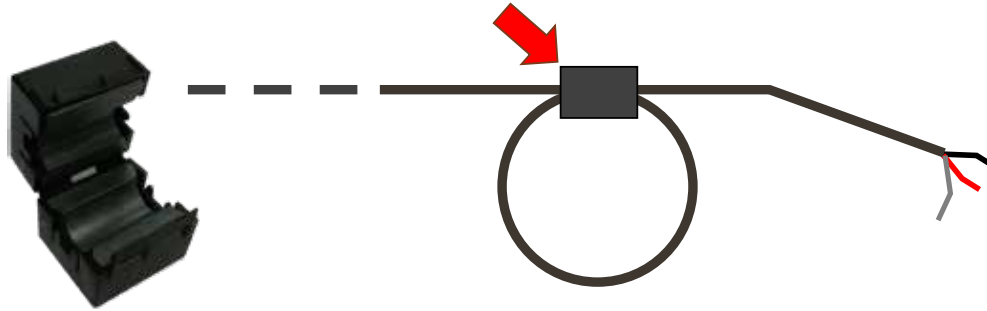

2. Connect one wire to terminal #42 (NEGATIVE), the other wire to terminal #43 (POSITIVE) and the drain wire to ground terminal #46.

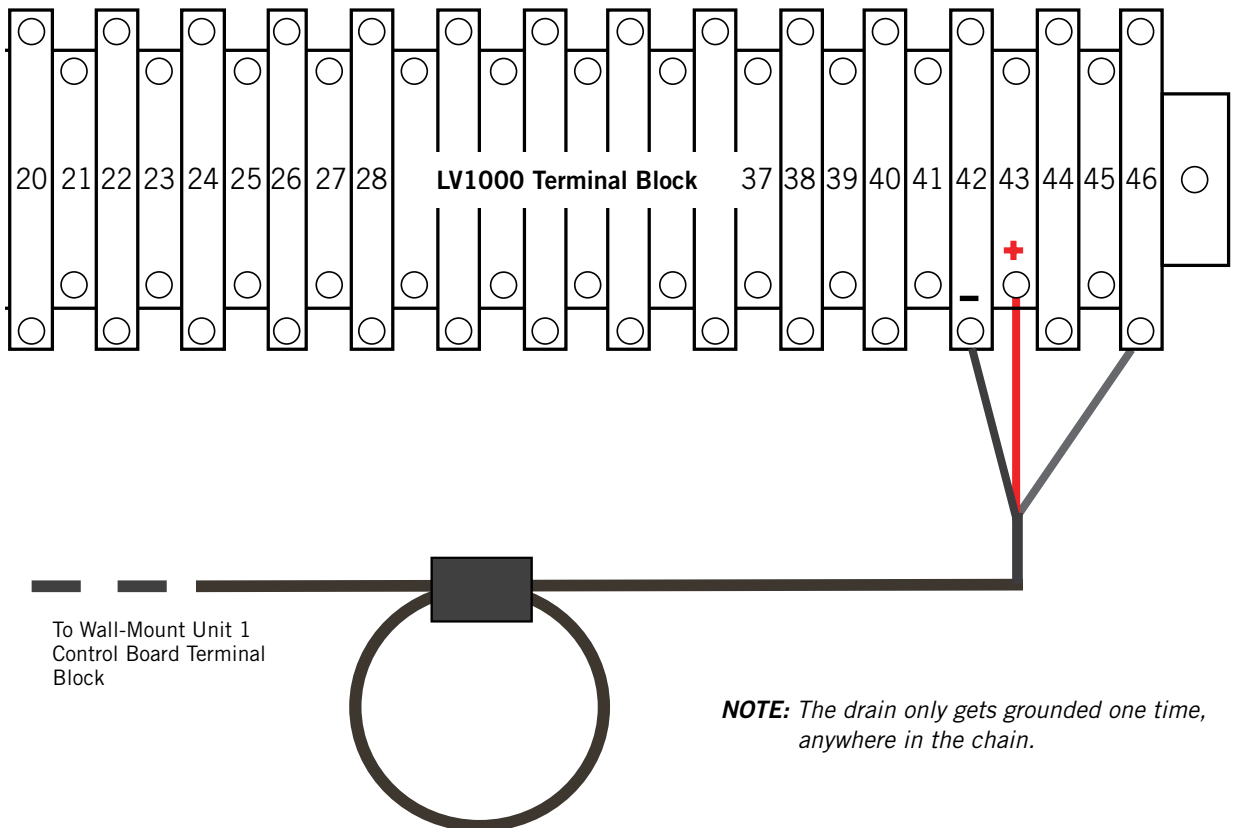
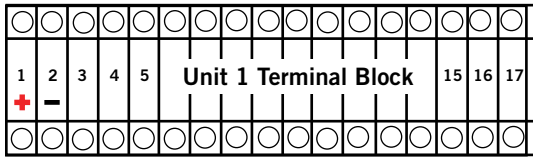
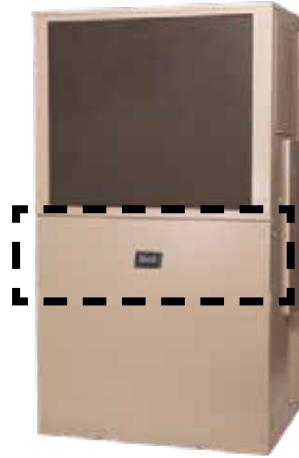

FIGURE 30
Communication Wiring: Termination at the First Wall-Mount Unit



1. From the controller, extend the shielded cable through a separate conduit and route to the provided terminal block next to the wall-mount control board.

These connections are polarity-sensitive. Two-wire communication from control board is prewired to terminal block. Make sure to match "+" and "-" symbols on controller terminal block.



Wall-Mount Unit 1

2. Connect the wires matching the terminal designations (+/-) of the controller terminals. Leave the drain wire loose.

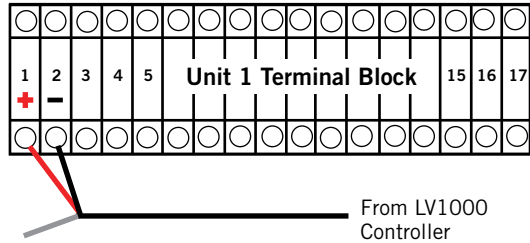

3. Connect another cable in a similar fashion ("daisy chain") to route in conduit to the second wall-mount unit. Connect both drain wires with wire nut.

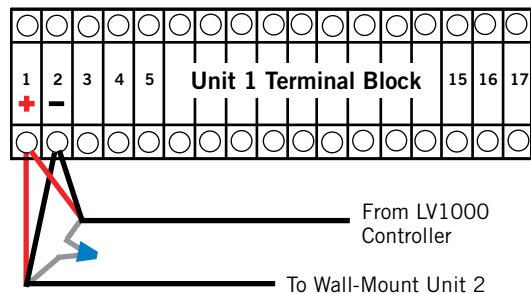
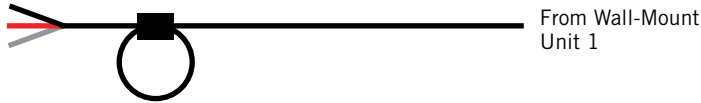
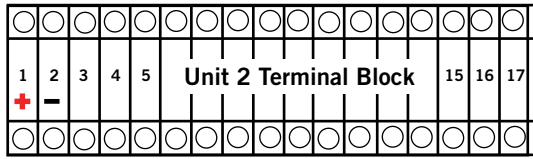

FIGURE 31
Communication Wiring: Termination at Additional Wall-Mount Units



Wall-Mount Unit 2

1. Route the cable from the first wall-mount unit to the terminal block of the second wall-mount unit. If this is the last unit to be connected, make a small service loop and attach EMI filter as shown.

2. Connect the wires matching the terminal designations (+/-) of the controller terminals. Cap the loose drain with a wire nut or electrical tape.

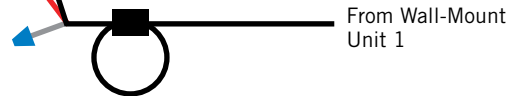
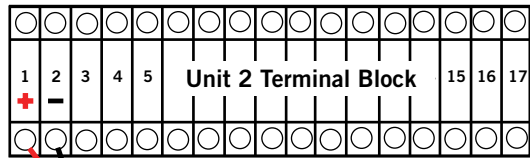

3. Continue daisy chaining units by connecting "+" to "+", "-" to "-" and wire nutting drain together until last unit which is capped with a wire nut. **Attach EMI filter as shown above at last unit.** Up to four wall-mount units can be connected and controlled by one LV1000 controller.

LV1000 Supply Wiring

The LV1000 controller is powered by -48VDC from the shelter. A field-supplied 5 amp DC circuit breaker is required. Field-supplied supply wiring should be minimum 16 gauge, maximum 14 gauge (see Figure 32). A reliable earth ground must be connected in addition to any grounding from conduit. Grounding bolts and nuts are included with the controller for this purpose; a 2 hole grounding lug must be field supplied. Install as shown in Figure 33. **Failing to ground the controller box properly could result in damage to the equipment.**

FIGURE 32
LV1000-300 Controller Supply Wiring

The controller requires a separate -48VDC power supply, an additional 5-amp DC breaker (field supplied) and minimum 16 gauge supply wire.

-48VDC termination at controller: Bring the -48VDC power supply wires through conduit to the controller box. Land the positive (+) 48VDC wire to terminal #1 and the negative (-) 48VDC wire to terminal #2.



NOTE: If the DC wiring is not terminated correctly on the specific polarity-indicated terminals of the block, the controller will not activate and will not function. Verify polarity of connections and wait to initialize controller until "system start up."

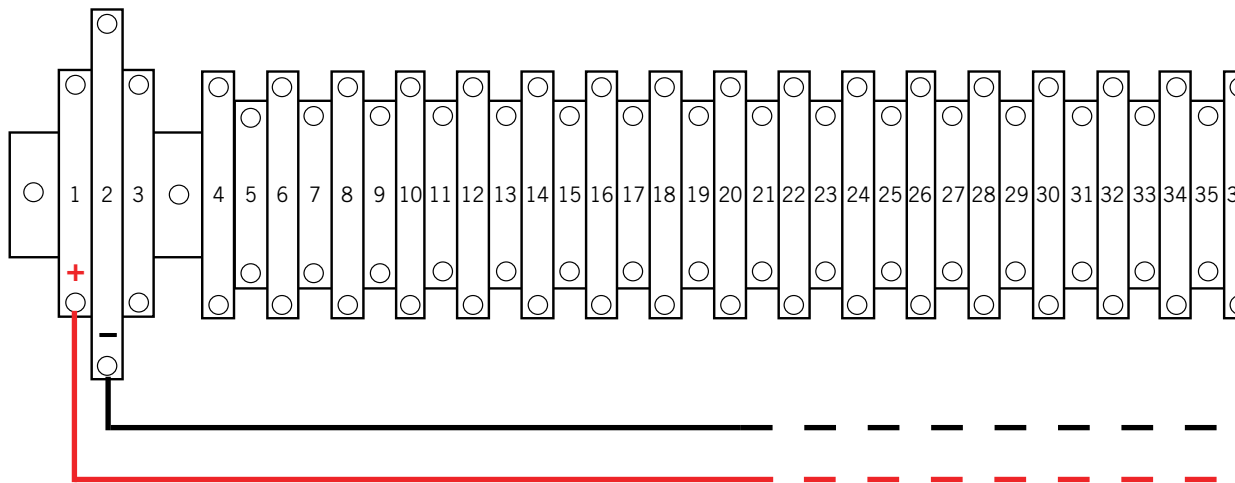

FIGURE 33
Controller Grounding Posts

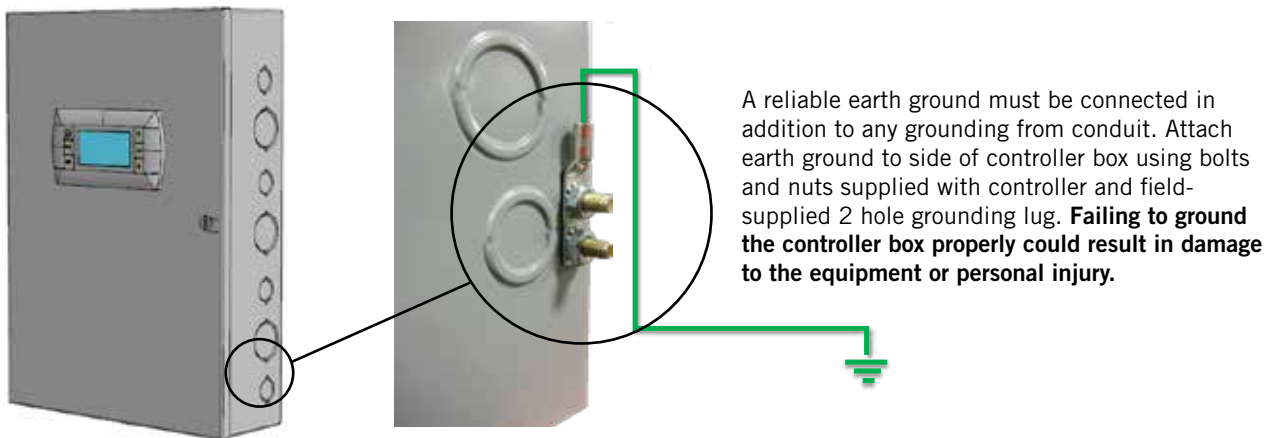
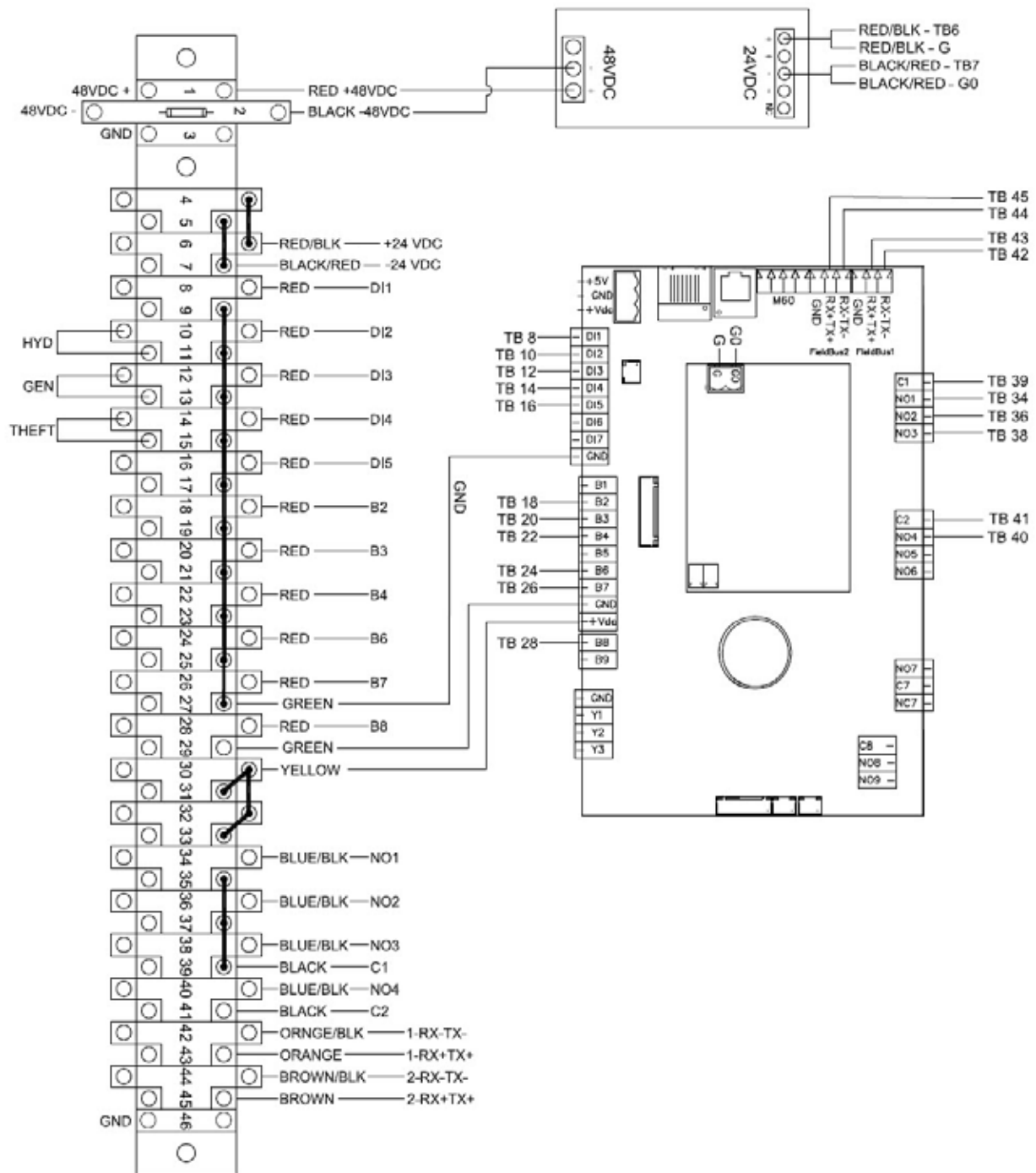

TABLE 5
LV1000-300 Terminal Block Index

TB#	Wire Mark	Description
1	48+	48VDC +Input
2	48-	48VDC - Input
3	GND	Ground
4	24+	24VDC +
5	24-	24VDC -
6	24+	24VDC +
7	24-	24VDC -
8	DI1	Smoke Detector Input
9	GND	Smoke Detector Common
10	DI2	Hydrogen Detector Input
11	GND	Hydrogen Detector Common
12	DI3	Generator Run Input
13	GND	Generator Run Common
14	DI4	Anti Theft Input
15	GND	Anti Theft Common
16	DI5	Inverter Fault Input
17	GND	Inverter Fault Common
18	B2	Humidity Sensor 1
19	GND	Ground
20	B3	Humidity Sensor 2
21	GND	Ground
22	B4	Humidity Sensor 3
23	GND	Ground

TB#	Wire Mark	Description
24	B6	Remote Temperature Sensor 1
25	GND	Ground
26	B7	Remote Temperature Sensor 2
27	GND	Ground
28	B8	Remote Temperature Sensor 3
29	GND	Ground
30	VDC+	Humidity Sensor 1 +24VDC (B2)
31	VDC+	Humidity Sensor 2 +24VDC (B3)
32	VDC+	Humidity Sensor 3 +24VDC (B4)
33	VDC+	Spare Power +24VDC
34	NO1	Humidifier Output Relay
35	C1	Common
36	NO2	HVAC Fail
37	C1	Common
38	NO3	HVAC Maintenance
39	C1	Common
40	NO4	HVAC Anti Theft
41	C2	Common
42	FB1R-	RS485 RX- / TX- (Wall Units)
43	FB1R+	RS485 RX+ / TX+ (Wall Units)
44	FB2R-	RS485 RX- / TX- (Fieldbus 1)
45	FB2R+	RS485 RX+ / TX+ (Fieldbus 1)
46	-	Ground

FIGURE 34
LV1000-300 Wiring Diagram



The LV1000 controller and TEC-EYE hand-held diagnostic tool will both be used to set up the Bard air conditioning system.

TEC-EYE™ Hand-Held Diagnostic Tool

The microprocessor control used in the FUSION-TEC HR Series wall-mount air conditioners allows for complete control and monitoring through the use of the provided TEC-EYE hand-held monitor.

The menu driven interface provides users the ability to scroll through two menu levels: Quick Menu and Main Menu. The menus permit the user to easily view, control and configure the unit. See latest version of FUSION-TEC HR Series Service Instructions manual 2100-694 for more information on using the TEC-EYE.

The TEC-EYE connects to the wall-mount unit control board via an RJ11 modular phone connector as shown in Figure 35.

When not being used, the TEC-EYE hand-held diagnostic tool should be stored inside or near the LV1000 controller. Do not let the TEC-EYE leave the shelter.

TEC-EYE Status Screen

The Status screen is the default start-up screen and also the return screen after 5 minutes of no activity. The screen can be accessed any time by pressing the ESCAPE key repeatedly.

FIGURE 35
TEC-EYE Connection to Unit Control

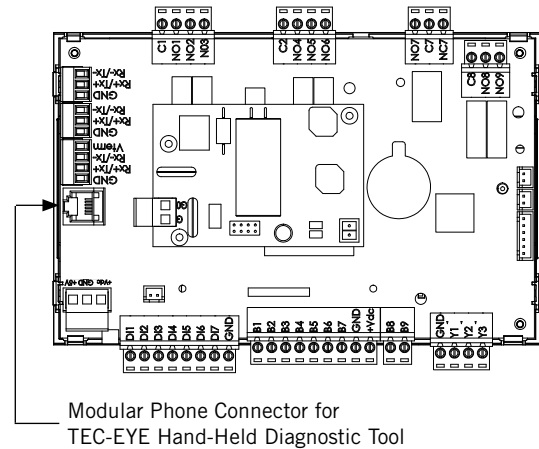

The wall-mount unit address is displayed in the upper right corner on the Status screen (see Figure 36). The Status screen also shows the current date, time, return air temperature, mixed air temperature, outdoor air temperature, outdoor humidity and outdoor dew point conditions. Blower speed, condenser fan speed, damper position and unit status are also displayed. See Table 7 on page 48 for wall-mount unit status messages.

FIGURE 36
TEC-EYE (Bard P/N 8301-059) Display and Interface (Status Screen Shown)



ALARM KEY

Allows viewing of active alarms
Silences audible alarms
Resets active alarms

MENU KEY

Allows entry to Main Menu

ESCAPE KEY

Returns to previous menu level
Cancels a changed entry

UP KEY

Steps to next screen in the display menu
Changes (increases) the value of a modifiable field

ENTER KEY

Accepts current value of a modifiable field
Advances cursor

DOWN KEY

Steps back to previous screen in the display menu
Changes (decreases) the value of a modifiable field

NOTE: Screenshots shown in this manual reflect default settings (when applicable).

NOTICE

It is important to check the software version during installation to ensure that the latest version has been installed. Current software versions and installation instructions are available on the Bard website at <http://www.bardhvac.com/software-download/>

Setting Up Wall-Mount Units for Operation

The TEC-EYE hand-held diagnostic tool is needed to set up the wall-mount unit(s).

1. Address Each Wall-Mount Unit

Each unit must have a unique address for the system to operate correctly with the LV controller (Ex: 1, 2, 3, 4 depending on the number of units). The unit only needs the address to be changed for the communication to work properly. The wall-mount unit address is displayed in the upper right corner on the Status screen on the TEC-EYE display (see Figure 36 on page 37).

To change the unit address:

- 1) Press MENU key to access the Main Menu screen.
- 2) Press UP or DOWN keys and ENTER key to enter TECHNICIAN password 1313.
- 3) Press UP or DOWN keys to scroll to **Sys Config**; press ENTER key.
- 4) Press UP or DOWN keys to scroll to **Unit Setup (A1)** screen.
- 5) Press ENTER key to scroll to **Unit Address** (see Figure 37).

FIGURE 37
Changing Unit Setup Values

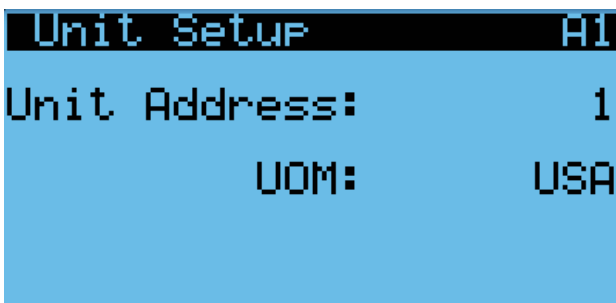

- 6) Press UP or DOWN keys to change the address to a value between 1 and 4.

NOTE: Each unit must have a unique address for the communication to work properly. Bard also recommends labeling each unit for ease in identification.

In addition to setting up the address, the user may also want to set the unit of measure (UOM) and economizer control type.

To change these settings:

- 1) Press MENU key to access the Main Menu screen.
- 2) Press UP or DOWN keys and ENTER key to enter TECHNICIAN password 1313.
- 3) Press UP or DOWN keys to scroll to **Sys Config**; press ENTER key.
- 4) Press UP or DOWN keys to scroll to **Unit Setup (A1)** screen.
- 5) Press ENTER key to scroll to **UOM** (see Figure 34).
- 6) If desired, press UP or DOWN keys to change the value from **USA** to **SI, NC, LON, CAN** or **UK**. Units are preconfigured for each selection.
- 7) Press ENTER key to save and move the cursor back to the top left position.
- 8) Press DOWN key to navigate to **Economizer Setup (A2)** screen.
- 9) Press ENTER key to scroll to **Type** (see Figure 38).
- 10) Press UP or DOWN keys to change economizer type to **None, Drybulb, Temperature and Humidity** or **Enthalpy**.
- 11) Press ENTER key to save.

Basic wall unit parameter settings are now set and the unit is ready to communicate with the LV.

NOTE: Once the wall unit is communicating with the LV, local cooling, heating and free cooling setpoints will be overridden with system setpoints from the LV.

FIGURE 38
Changing Economizer Control Type

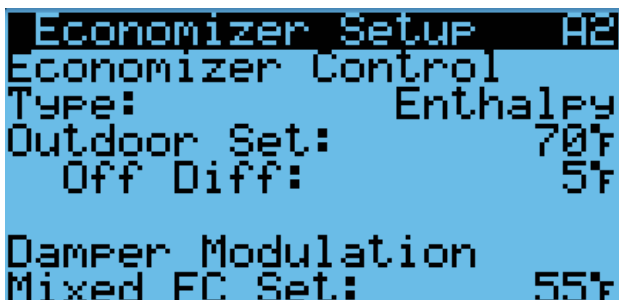

2. Execute a Run Test on Each Unit

Execute a run test on each unit to verify the equipment is functioning correctly. The run test parameters are not adjustable.

- 1) Press MENU key to access the Main Menu screen.
- 2) Press UP or DOWN keys and ENTER key to enter TECHNICIAN password 1313.
- 3) Press UP or DOWN keys to scroll to **Sys Config**; press ENTER key.
- 4) Press UP key to scroll to **Run Test (A10)** screen.
- 5) Press ENTER key to scroll to **Run Test Enable** (see Figure 39).
- 6) Press UP or DOWN key to change value to **ON**. The run test will begin and the screen will change to **Run Test Summary**.
- 7) Press UP or DOWN key to scroll between **Run Test Summary** (Figure 40), **Motors & Sensors** (Figure 41) and **A/C Circuit** (Figure 42) screens.

NOTE: If the Run Test screens have been exited out of, they can be returned to by navigating to **Run Test (A10)** as provided in the instructions above, pressing ENTER key to scroll to **Return to Screens**, pressing UP or DOWN key to change value to YES and pressing ENTER key.

FIGURE 39
Executing Run Test

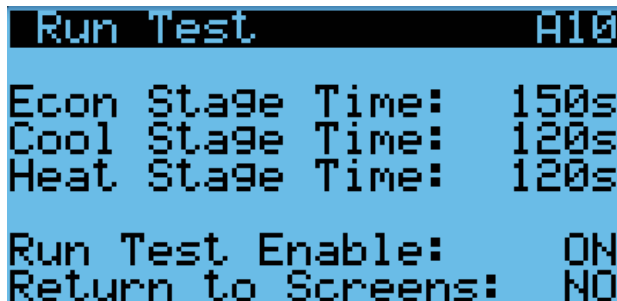

The **Run Test Summary** screen (Figure 40) contains a readout of the test that is currently taking place, and the Task the technician should be completing to verify operation.

The **Motors & Sensors** screen (Figure 41) displays output and estimated positional values for unit motors and actuators, and also temperature and humidity sensor values.

The **A/C Circuit** screen (Figure 42) displays all unit inputs, outputs and calculations associated with the A/C circuit operation.

FIGURE 40
Run Test Summary

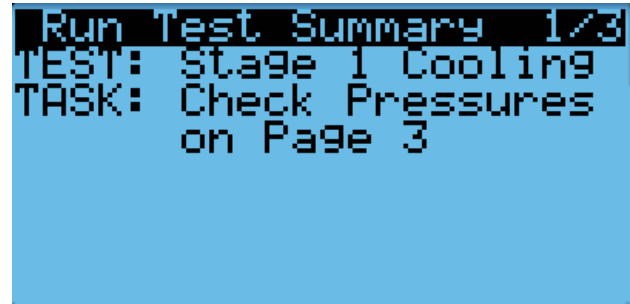

FIGURE 41
Run Test: Motors & Sensors

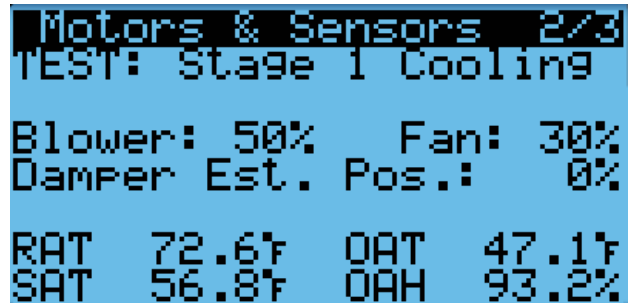
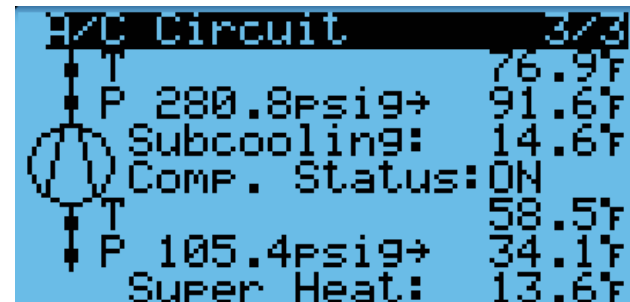

FIGURE 42
Run Test: A/C Circuit



Run Test Parameter Description

Econ Stage Time: Amount of time (in seconds) allowed for damper blade movement in each direction.

Cool Stage Time: Amount of time (in seconds) allowed for each stage of cooling.

Heat Stage Time: Amount of time (in seconds) allowed for heating stage.

3. Clear Unit Alarm Logs on Each Unit

To clear the wall-mount unit alarm logs:

- 1) Press MENU key to go to the Main Menu screen.
- 2) Use UP or DOWN keys and ENTER key to enter TECHNICIAN password 1313.

- 3) Press UP or DOWN keys to scroll to **Settings**; press ENTER key.
- 4) Press UP or DOWN keys to scroll to **Initialization**; press ENTER key.
- 5) Press ENTER key to scroll to **Clear Alarm Logs?** (see Figure 43).
- 6) Press UP or DOWN key to value to **YES**; press ENTER key.
- 7) Press ESCAPE key several times to return to Main Menu screen.

After each of the wall-mount units have been addressed, had a run test performed and had the alarm logs cleared, the rest of the system set up can proceed.

FIGURE 43
Clearing Unit Alarm Logs

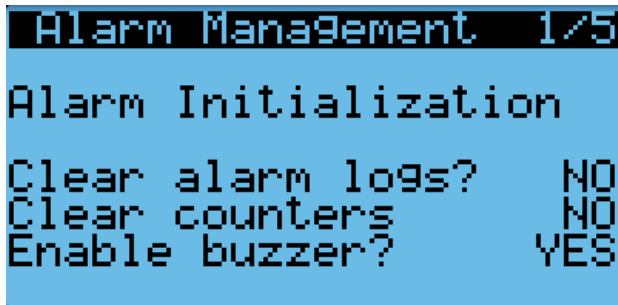

Setting Up LV1000 for Operation

The LV1000 controller will be used for the remaining steps in the set up process.

LV1000 Status Screen

The Status screen is the default start-up screen and also the return screen after 5 minutes of no activity on the LV1000. The screen can be accessed any time by pressing the ESCAPE key repeatedly.

The LV1000 Status screen displays the current date and time, indoor room conditions and system status (see Figure 45). See Table 8 on page 48 for system status messages.

4. Set LV Controller Timezone and Date/Time:

The FUSION-TEC HR Series/LV1000 system uses the LV1000 date/time to sync all attached wall-mount units on the system.

- 1) Press MENU key to access the Main Menu screen.
- 2) Press UP or DOWN keys and ENTER key to enter USER password 1313.
- 3) Press the UP or DOWN keys to scroll to the **Settings**; press ENTER key.
- 4) Press UP or DOWN keys to scroll to **Date/Time**; press ENTER key.
- 5) Press UP or DOWN keys to scroll to **Timezone**; press ENTER key.
- 6) Press UP or DOWN keys to scroll through available timezones (see Figure 44).

FIGURE 44
Changing Timezone

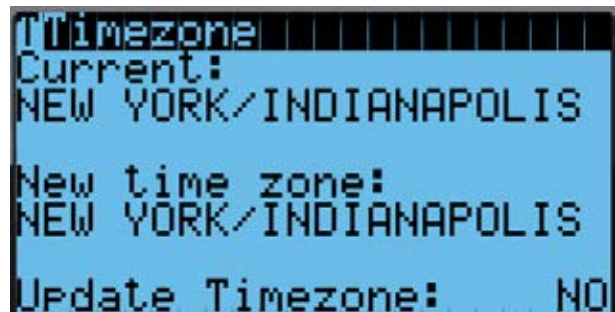

FIGURE 45
LV1000 Controller Display and Interface (Status Screen Shown)



LV1000 interface key functions are the same as those shown for the TEC-EYE in Figure 33 on page 34.

- 7) Press ENTER key to scroll to **Update Timezone**.
- 8) Press UP or DOWN key to change value to **YES**.
- 9) Press ENTER key to save and scroll to top of screen.
- 10) Press UP or DOWN keys to navigate to **Date/Time change**.
- 11) Press ENTER key to scroll to the desired value to be changed (see Figure 46).
- 12) Press UP or DOWN keys to change the value.
- 13) Press ENTER key to save.
- 14) Press the ESCAPE key several times to return to Main Menu screen.

FIGURE 46
Setting Controller Date and Time

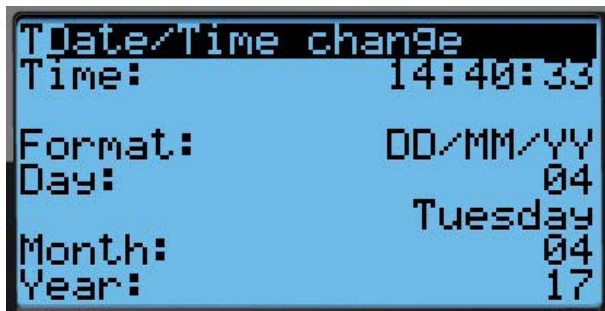

5. Configure NOC Relay Outputs

The LV1000 contains relay outputs for remote alarm monitoring site notification. These relays include an HVAC Fail alarm, HVAC Maintenance alarm and Anti-Theft (Bard Guard) alarm.

HVAC Fail Alarm

The LV monitors all connected wall-mount unit alarms. If any of the units communicate specific alarms, the LV will actuate an HVAC fail alarm relay output. The following wall-mount unit events have the possibility of actuating an HVAC failure: High pressure (always), low pressure (always), blower failure (always), high temperature warning (user selectable), high temperature alarm (user selectable) and low temperature alarm (user selectable). Each event will be displayed individually on the LV. However, any of these alarms (when enabled) will actuate the alarm relay for HVAC failure. This output is connected to the NOC for remote notification. When all of these events are no longer present, the alarm relay output will close, signaling there are no HVAC failure alarms.

The LV will actuate a relay output when this alarm occurs. The output is set up to open when an alarm occurs by default. The direction of this alarm output can be changed if required.

To change the direction of the HVAC fail alarm output:

- 1) Press MENU key to go to the Main Menu screen.
- 2) Use UP or DOWN keys and ENTER key to enter TECHNICIAN password 1313.
- 3) Press UP or DOWN keys to scroll to **IO Config**; press ENTER key.
- 4) Press UP or DOWN keys to scroll to **Digital Out Config (C2)**.
- 5) Press ENTER key to scroll to the variable in the table that intersects **HVACfail** and **Dir** (see Figure 47).
- 6) Press UP or DOWN key to change direction.

FIGURE 47
Changing Output Values

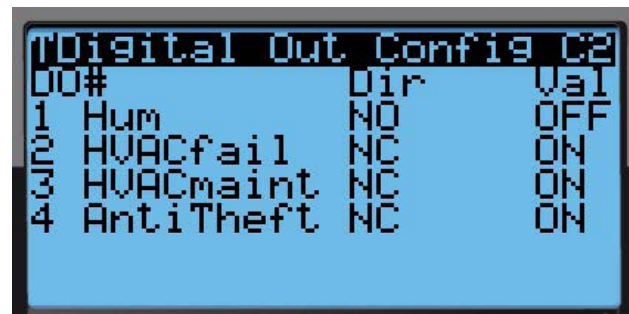

To change the alarms that actuate an HVAC fail alarm:

- 1) Press MENU key to go to the Main Menu screen.
- 2) Use UP or DOWN keys and ENTER key to enter TECHNICIAN password 1313.
- 3) Press UP or DOWN keys to scroll to **IO Config**; press ENTER key.
- 4) Press UP or DOWN keys to scroll to **HVAC Fail Config (C3)**.
- 5) Press ENTER key to scroll to the failure type enable (see Figure 48 on page 42).
- 6) Press UP or DOWN key to change value.
- 7) Press ENTER key to save.

FIGURE 48
Changing HVAC Fail Outputs



HVAC Maintenance Alarm

The LV monitors all connected wall-mount unit alarms, and if any of the units communicate specific alarms, the LV will actuate an HVAC maintenance alarm relay output. The following alarms/events have the possibility of actuating HVAC maintenance: Dirty filter alarm (always), dirty condenser coil alarm (always), lead +1/lag unit running (user delectable), economizer fail (user selectable), communications failure (user selectable). For all cases except lead +1, each of the alarms will be displayed individually on the LV. However, any of these alarms (when enabled) will actuate the alarm relay for HVAC maintenance, which is connected to the NOC for remote notification. When all of these events are no longer present, the alarm relay output will close signaling there are no HVAC maintenance alarms.

The LV will actuate a relay output when this alarm occurs. The output is set up to open when an alarm occurs by default. The direction of this alarm output can be changed if required.

To change the direction of the maintenance alarm output:

- 1) Press MENU key to go to the Main Menu screen.
- 2) Use UP or DOWN keys and ENTER key to enter TECHNICIAN password 1313.
- 3) Press UP or DOWN keys to scroll to **IO Config**; press ENTER key.
- 4) Press UP or DOWN keys to scroll to **Digital Out Config (C2)**.
- 5) Press ENTER key to scroll to the variable in the table that intersects **HVACmaint** and **Dir** (see Figure 47 on page 41).
- 6) Press UP or DOWN key to change direction.

To change the alarms that actuate an HVAC maintenance alarm:

- 1) Press MENU key to go to the Main Menu screen.

- 2) Use UP or DOWN keys and ENTER key to enter TECHNICIAN password 1313.
- 3) Press UP or DOWN keys to scroll to **IO Config**; press ENTER key.
- 4) Press UP or DOWN keys to scroll to **HVAC Maint Config (C4)**.
- 5) Press ENTER key to scroll to the maintenance type enable (see Figure 49).
- 6) Press UP or DOWN key to change value.
- 7) Press ENTER key to save.

FIGURE 49
Changing HVAC Maintenance Outputs

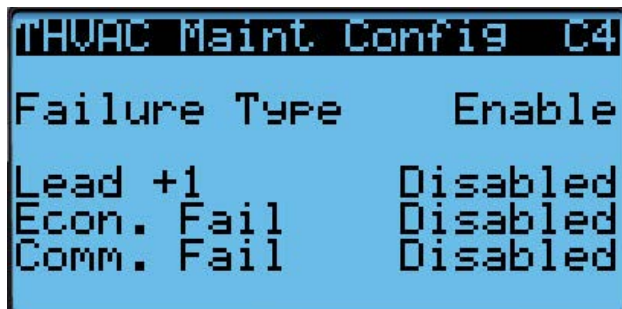

Anti-Theft Alarm

The LV will actuate a relay output when this alarm occurs. The output is set up to open when an alarm occurs by default. The direction of this alarm output can be changed if required.

To change the direction of the anti-theft alarm output:

- 1) Press MENU key to go to the Main Menu screen.
- 2) Use UP or DOWN keys and ENTER key to enter TECHNICIAN password 1313.
- 3) Press UP or DOWN keys to scroll to **IO Config**; press ENTER key.
- 4) Press UP or DOWN keys to scroll to **Digital Out Config (C2)**.
- 5) Press ENTER key to scroll to the variable in the table that intersects **AntiTheft** and **Dir** (see Figure 47 on page 41).
- 6) Press UP or DOWN key to change direction.

6. Configure Sensors

The system may need to be configured for the number of temperature and humidity sensors installed. The system is shipped with one combination temperature and humidity sensor. Additional combination sensors may be purchased or alternatively, temperature-only sensors may be purchased instead. The LV is capable of utilizing

three temperature sensors and three humidity sensors. The system may need to be configured for the various configurations.

NOTE: The Indoor Humidity 1 and Indoor Temperature 1 sensors are enabled by default. The additional indoor humidity and indoor temperature sensors are disabled by default.

If necessary, the sensors could be calibrated at this time too. For information on calibrating the sensors (adjusting the offset), see page 45.

To enable/disable **Indoor Humidity 1:**

- 1) Press MENU key to go to the Main Menu screen.
- 2) Press UP or DOWN keys and ENTER key to enter TECHNICIAN password 1313.
- 3) Press UP or DOWN keys to scroll to **IO Config**; press ENTER key.
- 4) Press UP or DOWN keys to scroll to **Indoor Humidity 1 (C6)**.
- 5) Press ENTER key to scroll to **Enable** (see Figure 50).
- 6) Press UP or DOWN key to change value to ON to enable sensor (or change value to OFF to disable sensor).

FIGURE 50
Configuring Indoor Humidity 1 Sensor

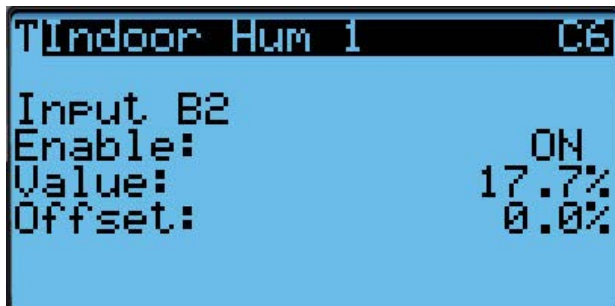

To enable/disable **Indoor Humidity 2:**

- 1) Press MENU key to go to the Main Menu screen.
- 2) Press UP or DOWN keys and ENTER key to enter TECHNICIAN password 1313.
- 3) Press UP or DOWN keys to scroll to **IO Config**; press ENTER key.
- 4) Press UP or DOWN keys to scroll to **Indoor Humidity 2 (C8)**.
- 5) Press ENTER key to scroll to **Enable** (see Figure 51).
- 6) Press UP or DOWN key to change value to ON to enable sensor (or change value to OFF to disable sensor).

FIGURE 51
Configuring Indoor Humidity 2 Sensor

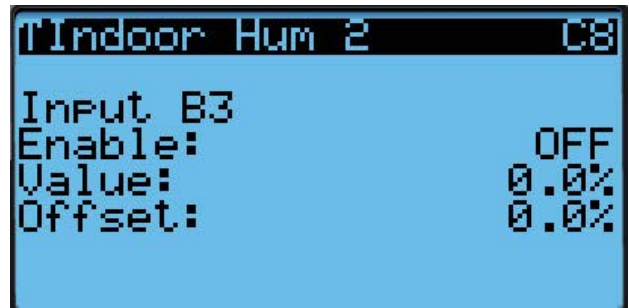

To enable/disable **Indoor Humidity 3:**

- 1) Press MENU key to go to the Main Menu screen.
- 2) Press UP or DOWN keys and ENTER key to enter TECHNICIAN password 1313.
- 3) Press UP or DOWN keys to scroll to **IO Config**; press ENTER key.
- 4) Press UP or DOWN keys to scroll to **Indoor Humidity 3 (C10)**.
- 5) Press ENTER key to scroll to **Enable** (see Figure 52).
- 6) Press UP or DOWN key to change value to ON to enable sensor (or change value to OFF to disable sensor).

FIGURE 52
Configuring Indoor Humidity 3 Sensor

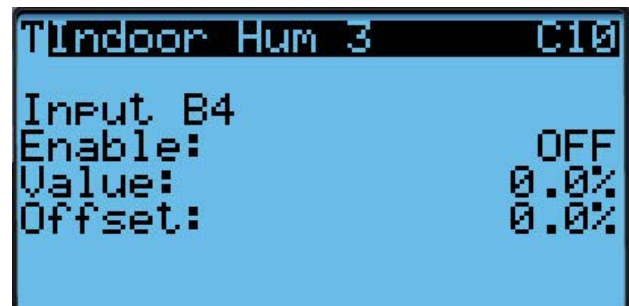

To enable/disable **Indoor Temperature 1:**

- 1) Press MENU key to go to the Main Menu screen.
- 2) Press UP or DOWN keys and ENTER key to enter TECHNICIAN password 1313.
- 3) Press UP or DOWN keys to scroll to **IO Config**; press ENTER key.
- 4) Press UP or DOWN keys to scroll to **Indoor Temperature 1 (C5)**.
- 5) Press ENTER key to scroll to **Enable** (see Figure 53 on page 44).

- 6) Press UP or DOWN key to change value to ON to enable sensor (or change value to OFF to disable sensor).

FIGURE 53
Configuring Indoor Temperature 1 Sensor

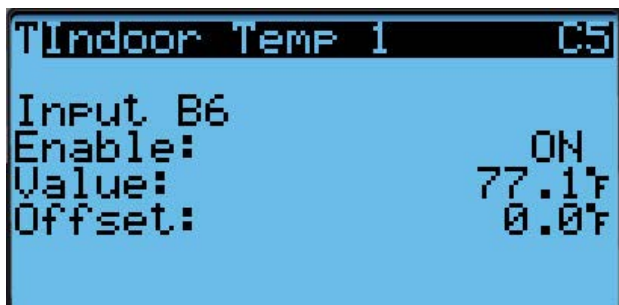

To enable/disable **Indoor Temperature 2**:

- 1) Press MENU key to go to the Main Menu screen.
- 2) Press UP or DOWN keys and ENTER key to enter TECHNICIAN password 1313.
- 3) Press UP or DOWN keys to scroll to **IO Config**; press ENTER key.
- 4) Press UP or DOWN keys to scroll to **Indoor Temperature 2 (C7)**.
- 5) Press ENTER key to scroll to **Enable** (see Figure 54).
- 6) Press UP or DOWN key to change value to ON to enable sensor (or change value to OFF to disable sensor).

FIGURE 54
Configuring Indoor Temperature 2 Sensor

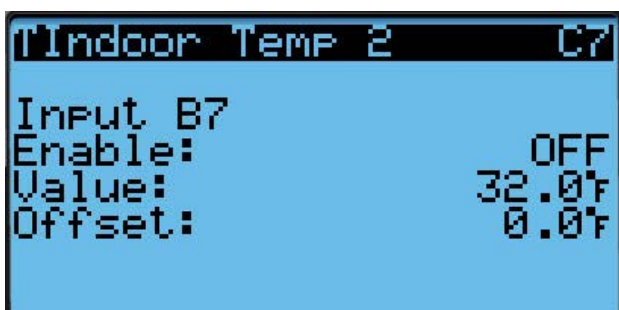

To enable/disable **Indoor Temperature 3**:

- 1) Press MENU key to go to the Main Menu screen.
- 2) Press UP or DOWN keys and ENTER key to enter TECHNICIAN password 1313.
- 3) Press UP or DOWN keys to scroll to **IO Config**; press ENTER key.

- 4) Press UP or DOWN keys to scroll to **Indoor Temperature 3 (C9)**.
- 5) Press ENTER key to scroll to **Enable** (see Figure 55).
- 6) Press UP or DOWN key to change value to ON to enable sensor (or change value to OFF to disable sensor).

FIGURE 55
Configuring Indoor Temperature 3 Sensor



See latest version of LV1000 Service Instructions manual 2100-673 for information on setting up the smoke, hydrogen, generator, anti-theft and inverter relays.

7. Enter Total Number of Units

- 1) Press MENU key to go to the Main Menu screen.
- 2) Press UP or DOWN keys and ENTER key to enter TECHNICIAN password 1313.
- 3) Press UP or DOWN keys to scroll to **Sys Config**; press ENTER key.
- 4) Press UP or DOWN keys to scroll to **Unit Setup (A1)**; press ENTER key.
- 5) Press ENTER key to scroll to **Total Units** (see Figure 56).
- 6) Press UP or DOWN keys to adjust value to correct number of units.
- 7) Press ENTER key to save value.

FIGURE 56
Entering Total Number of Units

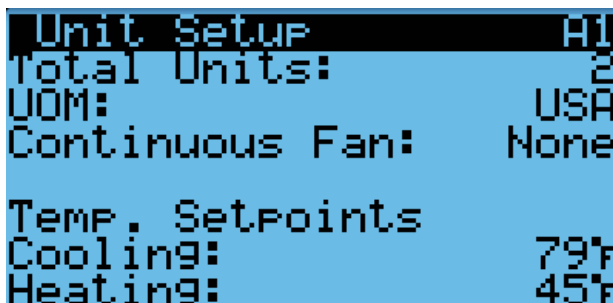

NOTE: The cooling and heating setpoints are also displayed on the **Unit Setup (A1)** screen. See **Control Operation** in LV1000 Service Instructions manual 2100-673 for information on adjusting the cooling and heating setpoints. Information on changing UOM (Units of Measure) and Continuous Fan settings can also be found in the LV1000 Service Instructions manual.

8) Press the ESCAPE key several times to return to Main Menu screen.

8. Verify Units Are Online

Once a unit is uniquely addressed, communication can be verified at the LV controller.

With the correct number of units set at the LV controller, each unit can be remotely viewed from the controller information screen.

To view these screens:

- 1) Press ESCAPE key to view the Status screen. (May need to be pressed more than once.)
- 2) Press UP or DOWN key until the Quick Menu in the lower right corner of the screen displays the Information icon (); press ENTER key.
- 3) Press UP or DOWN keys to scroll through the Information screens until the desired unit Information screen appears (see Figure 57). Three Info screens are available for each unit. Unit serial number and model number and 24-hour run time information can also be viewed on these screens.

In addition to being able to remotely view the units, an alarm will be generated on the LV controller for units not communicating.

FIGURE 57
Verifying Units



9. Clear Controller Alarm Logs

To clear the LV controller alarm logs:

- 1) Press MENU key to go to the Main Menu screen.
- 2) Use UP or DOWN keys and ENTER key to enter TECHNICIAN password 1313.

- 3) Press UP or DOWN keys to scroll to **Settings**; press ENTER key.
- 4) Press UP or DOWN keys to scroll to **Initialization**; press ENTER key.
- 5) Press ENTER key to scroll to **Clear Alarm Logs?** (see Figure 58).
- 6) Press UP or DOWN key to value to **YES**; press ENTER key.
- 7) Press ESCAPE key several times to return to Main Menu screen.

FIGURE 58
Clearing LV1000 Alarm Logs

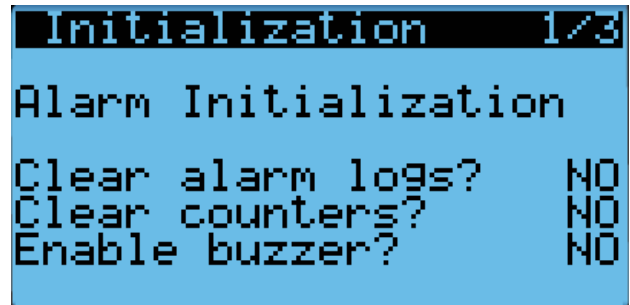

10. Complete Installation

Once all the installation steps have been completed, all alarms and alarm logs have been cleared and system verification and run test results were satisfactory, the installation can now be considered "complete".

Additional programming information can be found in FUSION-TEC HR Series Service Instructions manual 2100-694 and LV1000 Service Instructions manual 2100-673.

ADDITIONAL INFORMATION

Menu Screens and Password Levels

FUSION-TEC HR Series Unit

Quick Menu

Setpoints (Orphan Mode Temp. Setpoints)
Information
Alarm Log

Main Menu

System Config: A1-A10 User (2000)
Adv. System Config: B1-B4 Technician (1313)
I/O Config: C1-C18 Technician (1313)
On/Off: User (2000)
Alarm Logs: User (2000)
Settings
Date/Time: Technician (1313)
Language: User (2000)
Import/Export:
Parameter Config: Engineer (9254)
Alarm Export: User (2000)
Trend Log Export: User (2000)
Initialization
Clear Logs: User (2000)
System Default: Engineer (9254)
Serial Ports: Technician (1313)
Change Passwords
Logout: Used to log out of the current password level. Entering back into the menu requires password.

LV1000 Controller

Quick Menu

Setpoints (Comfort Mode)
Information
System Information
Unit 1 Information
Unit 2 Information (when configured)
Unit 3 Information (when configured)
Unit 4 Information (when configured)
Alarm Log

Main Menu

System Configuration: A1-A10 User (2000)
Adv. System Config: B1-B4 Technician (1313)
I/O Configuration: C1-C18 Technician (1313)
On/Off: User (2000)
Alarm Log: User (2000)
Settings
Date/Time: Technician (1313)
Language: User (2000)
Network Configuration: Technician (1313)
Modbus TCP Config: Technician (1313)
Import/Export: User (2000)
Initialization: User (2000)
Change Passwords
Logout

TABLE 6
LV1000/TEC-EYE Passwords (Defaults)

User	2000
Technician	1313
Engineer	9254
Use UP or DOWN keys and ENTER key to enter password	

Setpoints

The LV1000 setpoints will determine the cooling and heating setpoints when *communicating with the wall-mount units*. The *unit* cooling and heating setpoints will determine the cooling and heating setpoints when *in stand alone mode*.

If at any time the unit(s) loses communication with the LV1000 controller, the unit(s) will go into stand alone mode.

Calibrating Sensors

1. Press MENU key on LV controller interface to go to the Main Menu screen.
2. Use UP or DOWN keys and ENTER key to enter TECHNICIAN password 1313.
3. Press UP or DOWN keys to scroll to **I/O Config**; press ENTER key.
4. Press UP or DOWN keys to scroll to sensor to be adjusted (**Indoor Hum 1**, **Indoor Temp 1**, etc.).
5. Press ENTER key to scroll to **Offset** (see Figure 59).
6. Press UP or DOWN keys to add or subtract to the sensor offset value.
7. Press ENTER key to save.

FIGURE 59
Adjusting Sensor Offset Value

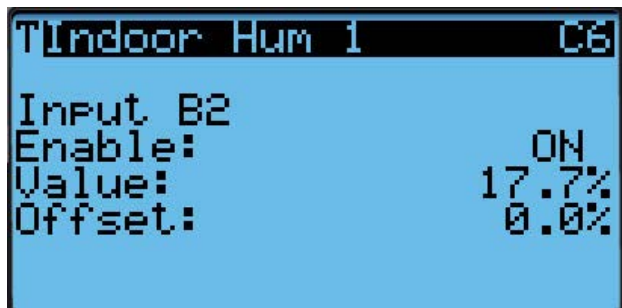

Reset to Factory Defaults

Both the LV1000 controller and FUSION-TEC HR Series wall-mount units can be reset to factory defaults. To reset an individual wall-mount unit, use the TEC-EYE hand-held tool.

To reset to factory default settings:

1. Press MENU key to go to the Main Menu screen.
2. Use UP or DOWN keys and ENTER key to enter ENGINEER password 9254.
3. Press UP or DOWN keys to scroll to **Settings**; press ENTER key.
4. Press UP or DOWN keys to scroll to **Initialization**; press ENTER key.
5. Press UP or DOWN keys to scroll to the **Default Installation** screen; press ENTER key.
6. Press ENTER key to scroll to **Reset to Factory Defaults** (see Figure 60). The wall-mount unit Default Installation screen is very similar to the LV screen shown.
7. Press UP or DOWN key to value to **YES**; press ENTER key.
8. System (or wall-mount unit) will restart with default values.

FIGURE 60
Restoring Factory Default Settings



TABLE 7
Unit Status Messages

Message	Description
Waiting...	PLC is on and has not started running the application yet.
Stand-Alone	Unit is on and in orphan mode with no calls for heating or cooling.
LV Online	Unit is on and communicating with the LV1000 with no heating or cooling calls.
Cont. Blower	Unit is operating with continuous blower when no heating or cooling calls are present.
Power Loss	Unit has experienced a loss of main utility power. Alarm only available with inverter units.
Freecooling	Unit is actively economizing.
Optimized Cool	Unit is mechanical cooling while actively economizing.
Cooling	Unit is actively mechanical cooling.
Heating	Unit is actively heating.
Passive Dehum	Unit is taking measures to decrease humidity without using extra energy.
Active Dehum	Unit is taking active measures to decrease humidity.
Self Test	Unit is performing a self test.
Off by Alarm	Unit has major fault preventing operation.
Off by DI	Unit is disabled by the local unit disable/smoke input.
Off by LV	Unit has been turned off by the supervisory controller.
Off by Keyboard	Unit has been turned off by the local user.
Override Active	There is an active override on the system.
Emergency Vent	Unit is in Emergency Ventilation. LV1000 has an active hydrogen alarm.
Emergency Cool	Unit is in Emergency Cooling. Indoor temperatures have exceeded high temp alarms.
Emergency Off	Unit is in Emergency Off. LV1000 has an active smoke alarm.

TABLE 8
LV1000 System Status Messages

Message	Description
Waiting...	POC is on and has not started the application yet.
Freecooling	System is actively economizing.
Cooling	System is actively mechanical cooling.
Optimized Cool	System is mechanical cooling while actively economizing.
Heating	System is actively heating.
Passive Dehum	System is taking measures to decrease humidity without using extra energy.
Active Dehum	System is taking active measures to decrease humidity.
Power Loss	Unit(s) in system have suffered a power loss.
Inverter Mode	System is operating on inverter power.
Off by Alarm	System has major fault preventing operation.
Off by BMS	System has been turned off from BMS system.
Off by Keypad	System has been turned off by local user.
Unit in Test	Unit(s) in system are currently conducting a self test.
Override Active	There is an active override on the system.
Comfort Mode	System is operating in Comfort Mode.
Emergency Vent	Unit is in Emergency Ventilation. System has active hydrogen alarm.
Emergency Cool	System is in Emergency Cooling. Indoor temperatures have exceeded high temp alarm.
Emergency Off	System is in Emergency Off. System has an active smoke alarm.

Remote Indoor Temperature/Humidity Sensor Orientation

Current versions of the remote indoor temperature/humidity sensor need to be installed with the shielded cable wires entering the bottom of the back of the sensor to connect to the sensor terminals (see Figure 61). Earlier versions of this sensor were installed so that the sensor wires entered through the top of the back of the sensor (see Figure 62). **The orientation of the sensor affects the position of the DP1/DP2 jumpers. Depending on how the sensor is installed, be sure to confirm that the jumpers are in the proper position for the 0-1 V setting as shown in the figures below.**

This applies to all indoor temperature/humidity sensors connected to the LV controller. See illustration mounted inside of sensor cover for further detail on jumper position.

FIGURE 61
Current Sensor Orientation
(Shielded Cable Wires Enter from Bottom)

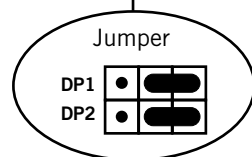
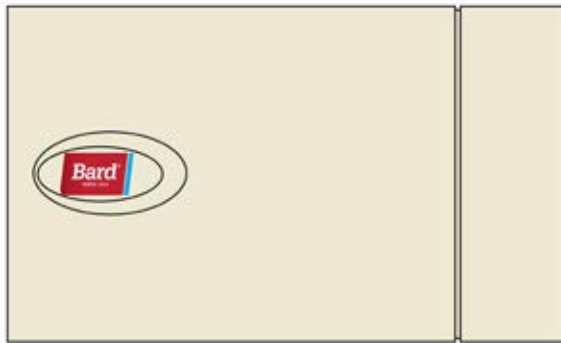

DP1 and DP2 Jumpers
 Positioned for 0-1V
 (Current Orientation)

FIGURE 62
Earlier Sensor Orientation
(Shielded Cable Wires Enter from Top)

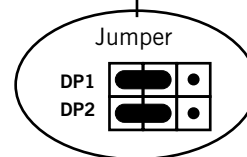
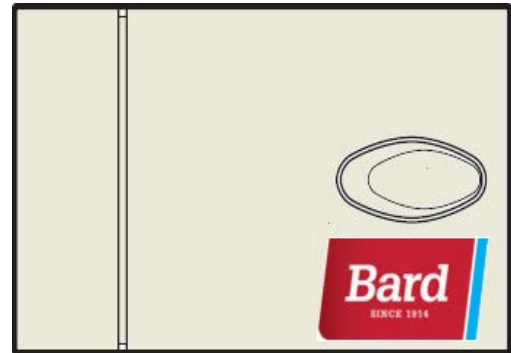

DP1 and DP2 Jumpers
 Positioned for 0-1V
 (Earlier Orientation)