SERVICE INSTRUCTIONS

WALL-MOUNT AIR CONDITIONER

Models:

WR36APA WR36APB
WR58APA WR58APB

Part of the Bard Free Cooling Unit System

NOTE: LC6000 controller is required for operation when multiple WR**AP* units are used.



Climate Control Solutions

Bard Manufacturing Company, Inc.
Bryan, Ohio 43506
www.bardhvac.com

Manual: 2100-688
Supersedes: **NEW**
Date: 4-6-18

CONTENTS

Using the TEC-EYE™6

TEC-EYE Hand-Held Diagnostic Tool	6
TEC-EYE Menu Structure	7
TEC-EYE Acronyms	7
Main Status Screen	7
Quick Menu	8
Setpoints	8
Information	8
Staging Information	8
Stand Alone Demand and Staging	8
Master Staging	8
A/C Circuit Measurements	9
Last 24 Hour Operation	9
Component Lifetime Hours	9
Software Versioning	9
Alarm Log	10
Menu Screens and Password Levels	10
Executing a Run Test	10
Run Test Parameters	11
Reset to Factory Defaults	11

Operation12

Unit On/Off	12
Alarm Adjustment	12
Acknowledging Alarms	12
Clearing Alarms	12
Clearing Alarm Logs and Counters	12
Exporting Alarm Logs	12
Exporting 7 Day Logs	13
Stand Alone (Orphan) Mode	13
Zone	13
Temperature/Humidity Control	14
Temperature/Humidity Control Components	14
Return Air Temperature Sensor	14
Return Air Temperature Alarm	14
Temperature/Humidity Control Operation	14
Cooling	14
Cooling w/No Economizer	14
Heating	14
Staging	14
Dehumidification	16
Electronic Expansion Valve (EEV)	16
EEV Components	16
Electronic Expansion Valve	16
Suction Pressure Transducer	16
Troubleshooting the Suction Pressure Transducer	16
Suction Pressure Alarm	17
Suction Temperature Sensor	17
Suction Temperature Alarm	17
Evaporator Freeze Condition Alarm	17
EEV Operation	18
EEV Superheat Control	18
EEV Instructions for Vacuum, Reclaim, Charge Unit	18
System Pressures	19
Additional EEV Alarms	19
Low Superheat Alarm	19
Indoor Airflow	19
Indoor Airflow Components	19

Blower	19
Blower Status Alarm	20
Differential Airflow Switch	20
Filters	21
Dirty Filter Switch	21
Dirty Filter Alarm	21
Filter Indicator Light	22
Freezestat	22
Indoor Airflow Operation	22
Blower Speed Control	22
Additional Indoor Airflow Alarms	22
Supply Air Temperature Alarm	22
Condenser Fan	23
Condenser Fan Components	23
Condenser Fan	23
Liquid Line Pressure Transducer	23
Troubleshooting the Discharge/ Liquid Pressure Transducer	24
Discharge/Liquid Pressure Transducer Alarm	24
Liquid Temperature Sensor	24
Condenser Fan Operation	24
Condenser Fan Speed Control	24
Mechanical Cooling Only	24
Optimized Cooling (Concurrent Economizer and Mechanical Cooling)	25
High Pressure Control	25
Condenser Fan Speed	25
Second Stage Drop Out	25
High Pressure Cut Out	25
Low Ambient Control	25
Additional Condenser Fan Alarms	25
Dirty Condenser Coil Alarm	25
Compressor	26
Compressor Components	26
Compressor	26
Compressor Control Module (CCM)	26
Delay-on-Make Timer	26
Short Cycle Protection/ Delay-on-Break	26
High Pressure Detection	26
Test Mode	27
Brownout Protection w/Adjustment	27
High Pressure Safety Switch	28
Refrigerant High Pressure Alarm	28
Phase Monitor	28
Compressor Operation	28
Additional Compressor Alarms	29
Refrigerant Low Pressure Alarm	29
Economizer	29
Economizer Components	29
Actuator	29
Dust Sensor	29
Dust Sensor Failure Alarm	30
High Dust Limit Alarm	30
Damper Blade	30
Damper Switch	30
Damper Failed to Open Alarm	31

Damper Failed to Close Alarm.....	31	Figure 23	Cooling w/No Economizer	15
Outdoor Temperature and Humidity		Figure 24	Heating	15
Combination Sensor	31	Figure 25	Viewing Unit Stages.....	16
Outdoor Temperature Sensor		Figure 26	Adjusting Suction Sensor/Transducer	
Failure Alarm	32		Pressure Values	16
Outdoor Humidity Sensor		Figure 27	Voltage to Pressure: Suction Pressure	
Failure Alarm	32		Transducer	17
Supply Temperature Sensor.....	32	Figure 28	Adjusting Suction Temperature Sensor	
Supply Temperature Sensor			Values	17
Failure Alarm	33	Figure 29	Adjusting Freeze Setpoint and Alarm	
High Supply Air Temperature			Delay.....	17
Alarm	33	Figure 30	Overriding EEV Output	18
Low Supply Air Temperature		Figure 31	Electronic Expansion Valve (EEV) and	
Alarm	33		Service Tool	18
Economizer Operation	33	Figure 32	Putting Blower Output into Override	
Emergency Cooling Mode.....	35		Mode.....	19
Emergency Ventilation Mode	35	Figure 33	Adjusting Air Flow Alarm Delay	20
Model/Serial Number Configuration.....	35	Figure 34	Dirty Filter Switch/Blower Status	
Electric Heat Option	35		Switch.....	21
Electric Heat Components	35	Figure 35	Verifying Differential Airflow Status	21
Electric Heating Element	35	Figure 36	Dirty Filter Switch and Filter Indicator	
Thermal Overload.....	35		Light	22
Electric Heat Operation	36	Figure 37	Verifying Condenser Fan Output	23
Bard Guard Anti-Theft System Option	36	Figure 38	Fan Blade Setting.....	23
Smoke Detector Unit Disable Option	36	Figure 39	Adjusting Discharge/Liquid Transducer	
Inverter Option.....	36		Pressure Values	23
Refrigerant Information	38	Figure 40	Voltage to Pressure: Discharge/Liquid	
General	38		Pressure Transducer.....	24
Topping Off System Charge	38	Figure 41	Adjusting Discharge/Liquid	
Safety Practices.....	38		Temperature Input	24
Important Installer Note.....	38	Figure 42	Condenser Fan Speed Control	25
R410-A Refrigerant Charge	38	Figure 43	Adjusting Dirty Condenser Coil Alarm	
Pressure Service Ports	39		Settings.....	26
Maintenance.....	40	Figure 44	8201-164 Compressor Control Module.....	27
Standard Maintenance Procedures.....	40	Figure 45	Adjusting Compressor Delays	28
Bard Guard Anti-Theft System Option	40	Figure 46	Adjusting Low Pressure Alarm Settings	29
		Figure 47	Damper Override	29
		Figure 48	Dust Sensor	30
		Figure 49	Adjusting Dust Sensor Alarm Setpoint	30
		Figure 50	Damper Switch.....	31
		Figure 51	Adjusting Damper Alarm Delay.....	31
		Figure 52	Outdoor Air Sensor	32
		Figure 53	Outdoor Humidity Sensor	32
		Figure 54	Supply Air Sensor	32
		Figure 55	Adjusting Supply Air Temperature	
			Differential	33
		Figure 56	Economizer Setup	34
		Figure 57	Economizer Setup – Enthalpy Control.....	34
		Figure 58	Economizer Setup – TempHum Control	34
		Figure 59	WR Series Wall-Mount Unit Model	
			Nomenclature	37
		Table 1	Unit Status Message	7
		Table 2	LC6000/TEC-EYE Passwords (Defaults)	10
		Table 3A	WR36AP* Blower Speeds.....	19
		Table 3B	WR58AP* Blower Speeds.....	20
		Table 4	Rated Airflow	20
		Table 5	Indoor Blower Performance.....	20
		Table 6	Maximum ESP of Operation:	
			Electric Heat Only	20
		Table 7	Filter Switch Pressure Settings	21
		Table 8	Economizer Default Settings.....	35
		Table 9	Cooling Pressures	39
FIGURES AND TABLES				
Figure 1	TEC-EYE Display and Interface	6		
Figure 2	TEC-EYE Connection to Unit Control	6		
Figure 3	Quick Menu Icons.....	8		
Figure 4	Cool and Heat Setpoints.....	8		
Figure 5	Stand Alone Demand and Staging	8		
Figure 6	Master Staging.....	8		
Figure 7	A/C Circuit Measurements	9		
Figure 8	Last 24 Operation.....	9		
Figure 9	Component Lifetime Hours.....	9		
Figure 10	Software Versioning	9		
Figure 11	Executing Run Test.....	10		
Figure 12	Run Test Summary	10		
Figure 13	Run Test: Motors & Sensors.....	11		
Figure 14	Run Test: A/C Circuit	11		
Figure 15	Restoring Factory Default Settings.....	11		
Figure 16	Clearing All Alarms	12		
Figure 17	Clearing Alarm Logs and Counters.....	12		
Figure 18	Exporting Alarm Logs	13		
Figure 19	Exporting 7 Day Log.....	13		
Figure 20	Changing Zone	14		
Figure 21	Adjusting Return Air Sensor.....	14		
Figure 22	Cooling w/Economizer	14		

GENERAL INFORMATION

Free Cooling Unit System

This Bard Free Cooling Unit System is composed of WR Series wall-mounted air conditioners matched with an LC6000 lead/lag controller. The wall mounts are specifically engineered for telecom/motor control center rooms.

NOTE: *The LC6000 lead/lag controller and WR Series wall-mount units are designed specifically to work together. The controller cannot run other Bard models or other brands of systems, nor can other controllers run the WR Series wall-mount units. They are a complete system, and must be used together.*

Wall-Mount Air Conditioner Units

The wall-mount units operate on VAC power. The units will supply 100% of rated cooling airflow in free cooling mode with ability to exhaust the same amount through the unit itself without any additional relief openings in the shelter.

Each of these units are fully charged with refrigerant and have optional auxiliary heat.

General

The equipment covered in this manual is to be installed by trained, experienced service and installation technicians.

The refrigerant system is completely assembled and charged. All internal wiring is complete.

The unit is designed for use without duct work. Flanges are provided for transition from unit to wall grilles.

These instructions explain the recommended method to install the air cooled self-contained unit and the electrical wiring connections to the unit.

These instructions and any instructions packaged with any separate equipment required to make up the entire air conditioning system should be carefully read before beginning the installation. Note particularly any tags and/or labels attached to the equipment.

While these instructions are intended as a general recommended guide, they do not supersede any national and/or local codes in any way. Authorities having jurisdiction should be consulted before the installation is made. See **Additional Publications** for information on codes and standards.

Sizing of systems for proposed installation should be based on heat loss and heat gain calculations made according to methods of Air Conditioning Contractors of America (ACCA). The supply flange should be installed in accordance with the *Standards of the National Fire Protection Association for the Installation of Air*

Conditioning and Ventilating Systems of Other Than Residence Type, NFPA No. 90A, and Residence Type Warm Air Heating and Air Conditioning Systems, NFPA No. 90B. Where local regulations are at a variance with instructions, installer should adhere to local codes.

Shipping Damage

Upon receipt of equipment, the cartons should be checked for external signs of shipping damage. If damage is found, the receiving party must contact the last carrier immediately, preferably in writing, requesting inspection by the carrier's agent.

These units must remain in upright position at all times.

Additional Publications

These publications can help when installing the air conditioner. They can usually be found at the local library or purchased directly from the publisher. Be sure to consult the current edition of each standard.

National Electrical CodeANSI/NFPA 70
Standard for the Installation of Air Conditioning
and Ventilating SystemsANSI/NFPA 90A
Standard for Warm Air Heating
and Air Conditioning SystemsANSI/NFPA 90B
Load Calculation for Residential Winter
and Summer Air Conditioning ACCA Manual J

For more information, contact these publishers:

Air Conditioning Contractors of America (ACCA)
1712 New Hampshire Ave. N.W.
Washington, DC 20009
Telephone: (202) 483-9370 Fax: (202) 234-4721

American National Standards Institute (ANSI)
11 West Street, 13th Floor
New York, NY 10036
Telephone: (212) 642-4900 Fax: (212) 302-1286

**American Society of Heating, Refrigeration and Air
Conditioning Engineers, Inc. (ASHRAE)**
1791 Tullie Circle, N.E.
Atlanta, GA 30329-2305
Telephone: (404) 636-8400 Fax: (404) 321-5478

National Fire Protection Association (NFPA)
Batterymarch Park
P. O. Box 9101
Quincy, MA 02269-9901
Telephone: (800) 344-3555 Fax: (617) 984-7057

ANSI Z535.5 Definitions:

DANGER: Indicate[s] a hazardous situation which, if not avoided, will result in death or serious injury. The signal word “DANGER” is to be limited to the most extreme situations. DANGER [signs] should not be used for property damage hazards unless personal injury risk appropriate to these levels is also involved.

WARNING: Indicate[s] a hazardous situation which, if not avoided, could result in death or serious injury. WARNING [signs] should not be used for property damage hazards unless personal injury risk appropriate to this level is also involved.

CAUTION: Indicate[s] a hazardous situation which, if not avoided, could result in minor or moderate injury. CAUTION [signs] without a safety alert symbol may be used to alert against unsafe practices that can result in property damage only.

NOTICE: [this header is] preferred to address practices not related to personal injury. The safety alert symbol shall not be used with this signal word. As an alternative to “NOTICE” the word “CAUTION” without the safety alert symbol may be used to indicate a message not related to personal injury.



WARNING

Electrical shock hazard.

Have a properly trained individual perform these tasks.

Failure to do so could result in electric shock or death.

WARNING

Fire hazard.

Maintain minimum 1/4" clearance between the supply flange and combustible materials.

Failure to do so could result in fire causing damage, injury or death.

WARNING

Heavy item hazard.

Use more than one person to handle unit.

Failure to do so could result in unit damage or serious injury.

CAUTION

Cut hazard.

Wear gloves to avoid contact with sharp edges.

Failure to do so could result in personal injury.

USING THE TEC-EYE™

FIGURE 1
TEC-EYE (Bard P/N 8301-059) Display and Interface (Status Screen Shown)



ALARM KEY

Allows viewing of active alarms
Silences audible alarms
Resets active alarms

MENU KEY

Allows entry to Main Menu

ESCAPE KEY

Returns to previous menu level
Cancels a changed entry

UP KEY

Steps to next screen in the display menu
Changes (increases) the value of a modifiable field

ENTER KEY

Accepts current value of a modifiable field
Advances cursor

DOWN KEY

Steps back to previous screen in the display menu
Changes (decreases) the value of a modifiable field

TEC-EYE Hand-Held Diagnostic Tool

The microprocessor control used in the WR Series wall-mount air conditioners allows for complete control and monitoring through the use of the provided TEC-EYE hand-held monitor. This comprehensive service tool utilizes the latest in state-of-the-art technology including a large, easy-to-read backlit LCD graphic display.

The menu driven interface provides users the ability to scroll through two menu levels: Quick Menu and Main Menu. The menus permit the user to easily view, control and configure the unit.

The controller is completely programmed at the factory; the default setpoints and their ranges are easily viewed and adjusted from the TEC-EYE display. The program and operating parameters are permanently stored on FLASH-MEMORY in case of power failure. The controller is designed to manage temperature levels to a user-defined setpoint via control output signals to the wall-mount air conditioning system.

The TEC-EYE connects to the wall-mount unit control board via an RJ11 modular phone connector as shown in Figure 2.

FIGURE 2
TEC-EYE Connection to Unit Control

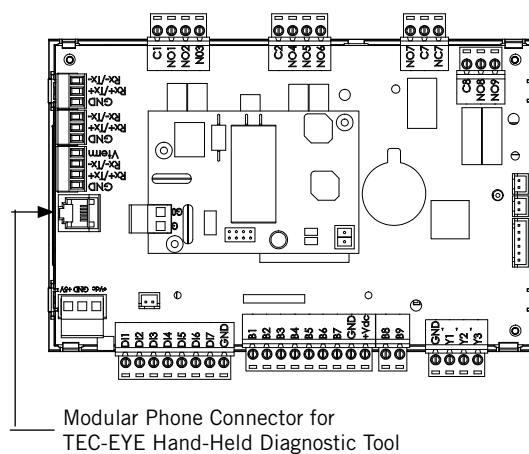

When not being used, the TEC-EYE hand-held diagnostic tool should be stored inside or near the LC6000 controller. Do not let the TEC-EYE leave the shelter.

NOTE: Screenshots shown in this manual reflect default settings (when applicable).

TEC-EYE Menu Structure

Quick Menu

- Setpoints
- Information
- Alarm Log

Main Menu

- System Configuration
- Advanced System Configuration
- I/O Configuration
- On/Off
- Alarm Logs
- Settings
 - Date/Time
 - Language
 - Initialization
 - Serial Ports
 - Change Password
- Logout

In addition to the menu structure above, there are also Status and Alarm screens.

TEC-EYE Acronyms

MAT – Mixed air temperature (calculated value)
 RAT – Return air temperature
 SAT – Supply air temperature
 OAT – Outdoor air temperature
 OAH – Outdoor air humidity
 ODP – Outdoor dew point (calculated value)
 Blower – Indoor blower speed
 Fan – Outdoor fan speed
 Damper – Free cooling damper position
 FC – Free cooling status
 CL1 – Compressor stage 1 status
 CL2 – Compressor stage 2 status
 H1 – Heater stage 1 status
 H2 – Heater stage 2 status
 ST – Number of start requests in last hour

NOTE: Digital refers to On/Off whereas analog is a variable input.

Main Status Screen

The main Status screen is the default start-up screen and also the return screen after 5 minutes of no activity. The screen can be accessed at any time by pressing the ESCAPE key repeatedly.

The wall-mount unit address is displayed in the upper right corner on the main Status screen (see Figure 1). The main Status screen also shows the current date, time, return air temperature (RAT), mixed air temperature (MAT), supply air temperature (SAT), outdoor air temperature (OAT), outdoor air humidity (OAH) and outdoor dew point (ODP) conditions. Blower speed, condenser fan speed, damper position and unit status are also displayed. See Table 1 for wall-mount unit status messages.

The Quick Menu is accessible from the main Status screen. Setpoints, Information and Alarm Log are

TABLE 1
Unit Status Messages

Message	Description
Waiting...	PLC is on and has not started running the application yet.
Stand-Alone	Unit is on and in orphan mode with no calls for heating or cooling.
LC Online	Unit is on and communicating with the LC6000 with no heating or cooling calls.
Cont. Blower	Unit is operating with continuous blower when no heating or cooling calls are present.
Power Loss	Unit has experienced a loss of main utility power. Alarm only available with inverter units.
Freecooling	Unit is actively economizing.
Optimized Cool	Unit is mechanical cooling while actively economizing.
Cooling	Unit is actively mechanical cooling.
Heating	Unit is actively heating.
Passive Dehum	Unit is taking measures to decrease humidity without using extra energy.
Active Dehum	Unit is taking active measures to decrease humidity.
Self Test	Unit is performing a self test.
Off by Alarm	Unit has major fault preventing operation.
Off by DI	Unit is disabled by the local unit disable/smoke input.
Off by LC	Unit has been turned off by the supervisory controller.
Off by Keyboard	Unit has been turned off by the local user.
Override Active	There is an active override on the system.
Emergency Vent	Unit is in Emergency Ventilation. LC6000 has an active hydrogen alarm.
Emergency Cool	Unit is in Emergency Cooling. Indoor temperatures have exceeded high temp alarms.
Emergency Off	Unit is in Emergency Off. LC6000 has an active smoke alarm.

available through the Quick Menu. Pressing the UP or DOWN keys while on the main Status screen will change the Quick Menu icon displayed (see Figure 3). Press the ENTER key when the desired icon is displayed.

FIGURE 3
Quick Menu Icons



Quick Menu

Setpoints

From this screen, the local unit heating and cooling setpoints, used for stand alone operation only, can be changed.

Once the supervisory controller is connected, cooling and heating setpoints will be communicated and local cooling and heating setpoints will be replaced with the communicated cooling and heating setpoints.

If at any time the wall-mount unit(s) loses communication with the LC6000 controller, the wall-mount unit(s) will go into stand alone mode and operate using the last communicated setpoints.

To verify or change the wall-mount unit cooling and heating setpoints in stand alone mode:

1. Connect the TEC-EYE diagnostic tool to the control board located in the unit.
2. From the Status screen, press UP or DOWN key until Quick Menu displays Setpoints icon. Press ENTER key.
3. Press ENTER key to scroll to the selected choice (see Figure 4).
4. Press UP or DOWN key on desired value until value displays correctly.
5. Press ENTER key to save and scroll to next parameter.
6. Press ESCAPE key until Main Menu screen is displayed.

FIGURE 4
Cool and Heat Setpoints



Information

The information screens are used as a quick reference to show unit operational information such as staging, A/C circuit measurements, last 24 hour run times, component lifetime hours and software versioning.

Staging Information

Staging information is used show any unit operation that should be taking place. The look of the staging display depends on if the unit is communicating with a supervisory controller.

Stand Alone Demand and Staging

If the unit is operating in a stand alone mode, the title will display as **Unit Demand** (see Figure 5). This signifies that the local unit has control of the unit heating and cooling stages.

FIGURE 5
Stand Alone Demand and Staging



Master Staging

If the unit is communicating with a supervisory controller, the title will display as **Master Staging** (see Figure 6). This signifies that the supervisory controller has control of the unit heating and cooling stages.

FIGURE 6
Master Staging

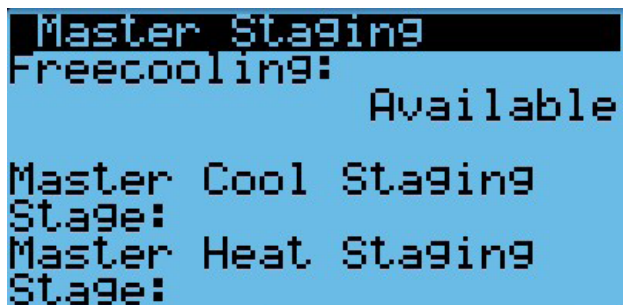

A/C Circuit Measurements

A/C Circuit Information can be found in two screens within the information menu (see Figure 7). The information and measurements provided are liquid line temperature, liquid line pressure, condensing saturated temperature, suction line temperature, suction line pressures, suction saturated temperature, super heat, sub-cooling and electronic expansion valve position.

FIGURE 7
A/C Circuit Measurements

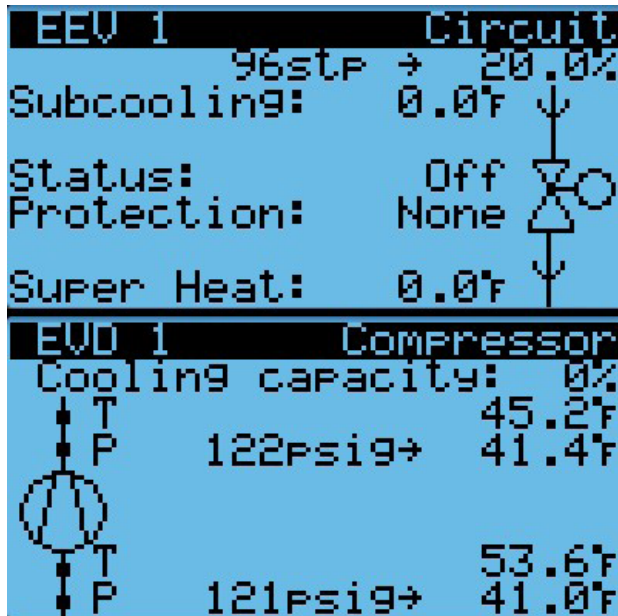

Last 24 Hour Operation

Last 24 Hour Operation information tracks the runtimes (**Time**) and start calls (**Start**) of different components or operations in the last 24 hour period (see Figure 8).

FIGURE 8
Last 24 Hour Operation

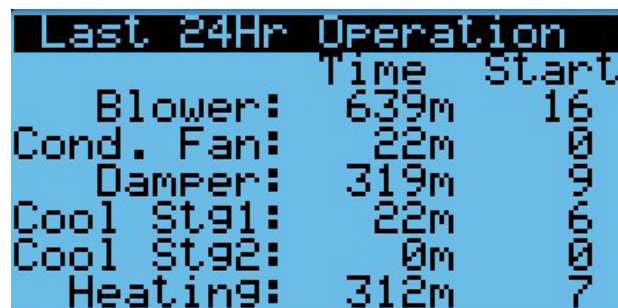

Component Lifetime Hours

Component Lifetime tracks the actual runtime of the following system components: Blower fan, condenser fan, compressor and damper actuator (see Figure 9).

FIGURE 9
Component Lifetime Hours



Software Versioning

The Software Version screen displays the model number of the unit as well as all software version information for the PLC (see Figure 10). This information can be used to determine whether a software update may be required based on information found in the software change log. This change log can be found at <http://www.bardhvac.com/software-download/>.

FIGURE 10
Software Versioning

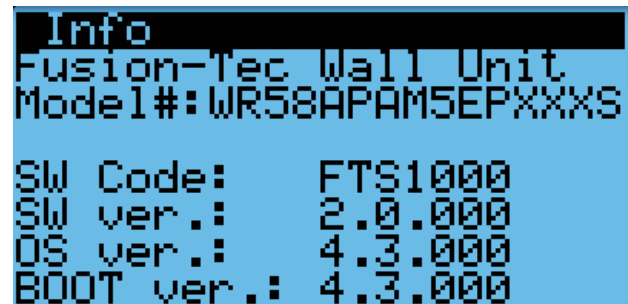

NOTICE

It is important to check the software version during installation to ensure that the latest version has been installed. Current software versions, change log and installation instructions are available on the Bard website at <http://www.bardhvac.com/software-download/>

Alarm Log

The alarm log screens show a log of each alarm. There will be a log for when alarm occurred and if the alarm auto clears, it will show when the alarm cleared.

Menu Screens and Password Levels

- A** System Config: A1-A10 User (2000)
- B** Adv Sys Config: B1-B4 Technician (1313)
- C** I-O Config: C1-C18 Technician (1313)
- D** On/Off: User (2000)
- E** Alarm Logs: User (2000)
- F** Settings
 - Date/Time: Technician (1313)
 - Language: User (2000)
 - Network Config: Technician (1313)
 - Serial Ports: Technician (1313)
 - Initialization
 - Clear Logs: User (2000)
 - System Default: Engineer (9254)
 - Restart: User (2000)
 - Parameter Config: Engineer (9254)
 - Alarm Export: User (2000)
- G** Logout: Used to log out of the current password level. Entering back into the menu requires password.

TABLE 2
LC6000/TEC-EYE Passwords (Defaults)

User	2000
Technician	1313
Engineer	9254
Use UP or DOWN keys and ENTER key to enter password	

Executing a Run Test

This unit has the ability to perform a run test that will operate all available unit functions in order to quickly determine unit operation. Some unit parameters are adjustable.

To execute a run test:

1. Press MENU key to access the Main Menu screen.
2. Press UP or DOWN keys and ENTER key to enter TECHNICIAN password 1313.
3. Press UP or DOWN keys to scroll to **Sys Config**; press ENTER key.
4. Press UP or DOWN keys to scroll to **Run Test (A10)** screen.

5. Press ENTER key to scroll to **Run Test Enable** parameter (see Figure 11).
6. Press UP or DOWN key to change value to ON. The run test will begin and the screen will change to **Run Test Summary**.
7. Press UP or DOWN key to scroll between **Run Test Summary** (Figure 12), **Motors & Sensors** (Figure 13) and **A/C Circuit** (Figure 14) screens.

NOTE: If the Run Test screens have been exited out of, they can be returned to by navigating to **Run Test (A10)** as provided in the instructions above, pressing ENTER key to scroll to **Return to Screens**, pressing UP or DOWN key to change value to YES and pressing ENTER key.

FIGURE 11
Executing Run Test

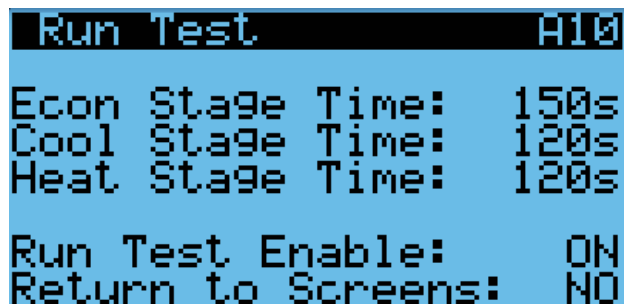

The **Run Test Summary** screen contains a readout of the test that is currently taking place, and the Task the technician should be completing to verify operation.

FIGURE 12
Run Test Summary

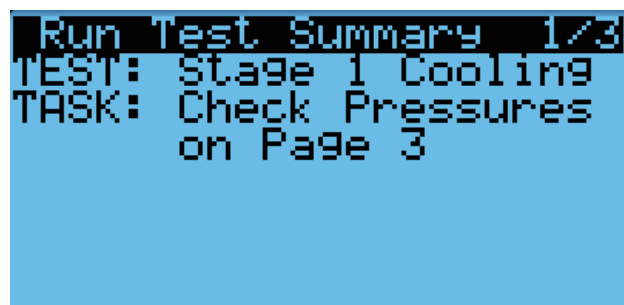

The **Motors & Sensors** screen displays output and estimated positional values for unit motors and actuators, and also temperature and humidity sensor values.

FIGURE 13
Run Test: Motors & Sensors

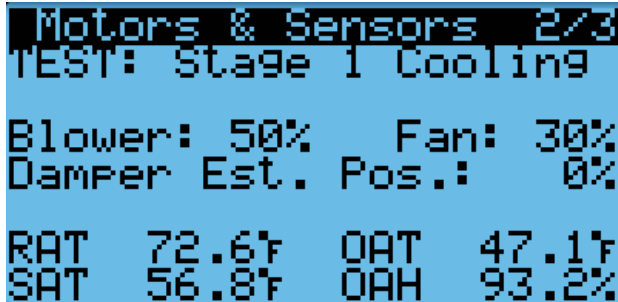

The **A/C Circuit** screen displays all unit inputs, outputs and calculations associated with the A/C circuit operation.

FIGURE 14
Run Test: A/C Circuit

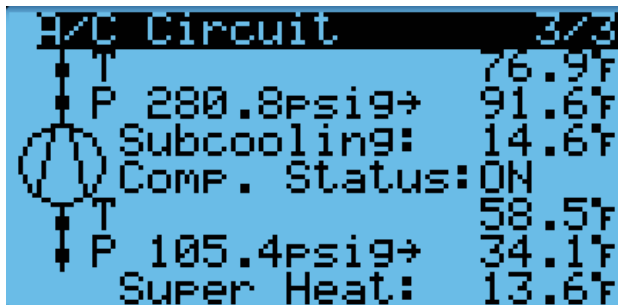

Run Test Parameter Description

Econ Stage Time: Amount of time (in seconds) allowed for damper blade movement in each direction.

Cool Stage Time: Amount of time (in seconds) allowed for each stage of cooling.

Heat Stage Time: Amount of time (in seconds) allowed for heating stage.

Reset to Factory Defaults

To reset to factory default settings:

1. Press MENU key to go to the Main Menu screen.
2. Use UP or DOWN keys and ENTER key to enter ENGINEER password 9254.
3. Press UP or DOWN keys to scroll to **Settings**; press ENTER key.
4. Press UP or DOWN keys to scroll to **Initialization**; press ENTER key.
5. Press UP or DOWN keys to scroll to the **Default Installation** screen; press ENTER key.
6. Press ENTER key to scroll to **Reset to Factory Defaults** (see Figure 15).
7. Press UP or DOWN key to change value to **YES**; press ENTER key.
8. System will restart with default values.

FIGURE 15
Restoring Factory Default Settings



OPERATION

NOTE: Screenshots shown in this manual reflect default settings (when applicable).

Unit On/Off

The wall-mount unit can be turned on and off from the TEC-EYE. Turning the unit off with the following instructions will disable all unit operation.

To turn the unit on or off:

1. Press MENU key to go to the Main Menu screen.
2. Press UP or DOWN keys and ENTER key to enter USER password 2000.
3. Press UP or DOWN keys to scroll to **On/Off**; press ENTER key.
4. Press UP or DOWN keys to change value from On to Off or from Off to On.
5. Press ESCAPE key several times to return to Main Menu screen.

The wall-mount unit may also be turned off by certain alarms such as the smoke alarm input on the wall-mount unit board or the return air temperature sensor failure when not connected to the LC6000.

Alarm Adjustment

Acknowledging Alarms

Alarm conditions activate a red LED indicator that backlights the ALARM function key. As an option, an alarm condition may also be enunciated by an audible alarm signal. An alarm is acknowledged by pressing the ALARM key. This calls up alarm display screen(s) that provide a text message detailing the alarm condition(s).

Clearing Alarms

Alarms can only be cleared after the alarm condition has been corrected. To clear a single alarm, press and hold the ALARM key for 3 seconds while viewing a specific alarm screen. To clear all alarms, navigate to the screen at the end of the alarm list (shown in Figure 16) and press and hold the ALARM key for 3 seconds.

FIGURE 16
Clearing All Alarms



Clearing Alarm Logs and Counters

To clear the alarm log and alarm counters:

1. Press MENU key to go to the Main Menu screen.
2. Use UP or DOWN keys and ENTER key to enter USER password 2000.
3. Press UP or DOWN keys to scroll to **Settings**; press ENTER key.
4. Press UP or DOWN keys to scroll to **Initialization**; press ENTER key. (**Alarm Management** screen will be displayed.)
5. Press ENTER key to scroll to **Clear Alarm Logs?** (see Figure 17).
6. Press UP or DOWN key to change value to **YES**; press ENTER key.
7. Press ENTER key to scroll to **Clear Counters**.
8. Press UP or DOWN key to value to **YES**; press ENTER key.

FIGURE 17
Clearing AlarmLogs and Counters

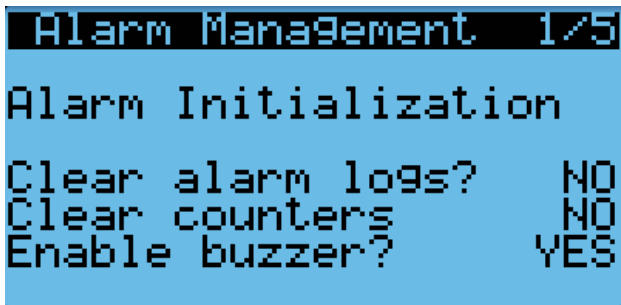

Exporting Alarm Logs

To export an alarm log:

1. Press MENU key to go to the Main Menu screen.
2. Use UP or DOWN keys and ENTER key to enter USER password 2000.
3. Press UP or DOWN keys to scroll to **Settings**; press ENTER key.
4. Press UP or DOWN keys to scroll to **Initialization**; press ENTER key.
5. Press UP or DOWN keys to scroll to **Alarm Log Export**.
6. Press ENTER key to scroll to **File Name** (see Figure 18).

NOTE: Make sure Memory type is set as INTERNAL FLASH MEMORY to ensure proper download.

7. Press UP or DOWN key to change the AL_EXPORT number, if desired.

8. Press ENTER key to scroll to **Confirm?**
9. Press UP or DOWN key to change value to **YES**; press ENTER key.
10. After download is complete, insert USB cable to remove file from PLC memory.

FIGURE 18
Exporting Alarm Logs

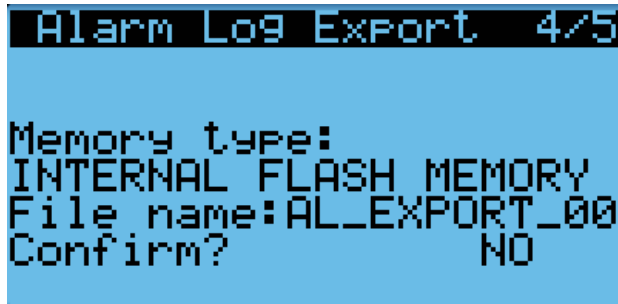

Exporting 7 Day Logs

To export a 7 day log:

1. Press MENU key to go to the Main Menu screen.
2. Use UP or DOWN keys and ENTER key to enter USER password 2000.
3. Press UP or DOWN keys to scroll to **Settings**; press ENTER key.
4. Press UP or DOWN keys to scroll to **Initialization**; press ENTER key.
5. Press UP or DOWN keys to scroll to **I/O Log Export**.
6. Press ENTER key to scroll to **File Name** (see Figure 19).

NOTE: Make sure Memory type is set as INTERNAL FLASH MEMORY to ensure proper download.

7. Press UP or DOWN key to change the FT_LOG number, if desired.
8. Press ENTER key to scroll to **Confirm?**
9. Press UP or DOWN key to change value to **YES**; press ENTER key.
10. After download is complete, insert USB cable to remove file from PLC memory.

FIGURE 19
Exporting 7 Day Log

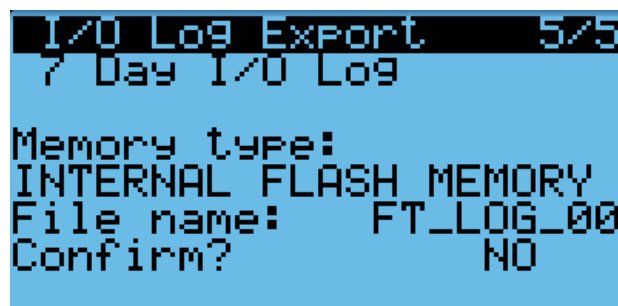

Stand Alone (Orphan) Mode

WR Series wall-mount units have the capability to run without the LC6000 controller attached—this feature is called stand alone or orphan mode. This keeps the shelter between 50°F and 79°F (factory default settings) by the use of the factory-installed return air sensor in each wall-mount unit. In stand alone mode, no auxiliary temperature measurement devices are required for operation. The wall-mount unit automatically uses a continuous blower setting to circulate room air into the return air inlet and uses the return air temperature sensor to control room temperature.

To change default setpoints, refer to **Setpoints** on page 8.

During installation, the ability to run in stand alone mode allows deactivation of one of the existing, older wall-mount units, while keeping the shelter cool with the other unit still operating. Once the first of the Bard wall-mount units is installed and powered on, it will operate in orphan mode—keeping the climate inside the shelter stable and the installers comfortable while the remainder of the older equipment is removed and the remaining Bard wall-mount units and LC6000 controller are installed.

Additionally, should any or all of the HR Series wall-mount units lose communication with the LC6000 controller (such as during maintenance), they will continue to serve the shelter's needs until a repair can be made.

Zone

When paired with a supervisory controller that uses zones to control groups of wall units, this unit uses the zone setting to relay to the supervisory controller what zone it is set to operate in.

To change the zone:

1. Press MENU key to access the Main Menu screen.
2. Press UP or DOWN keys and ENTER key to enter TECHNICIAN password 1313.
3. Press UP or DOWN keys to scroll to **Sys Config**; press ENTER key.
4. Press UP or DOWN keys to scroll to **Unit Setup (A1)** screen.
5. Press ENTER key to scroll to **Zone** (see Figure 20 on page 14).
6. Press UP or DOWN keys to change to the desired value.
7. Press ENTER key to save value.

FIGURE 20
Adjusting Return Air Sensor

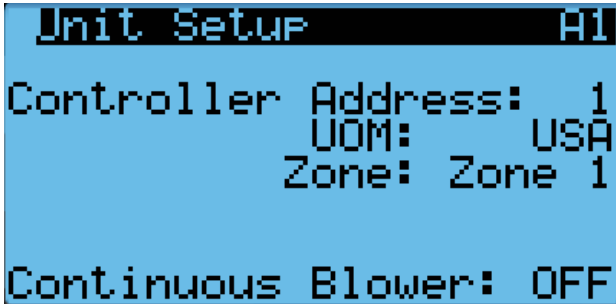

Temperature/Humidity Control

Temperature/Humidity Control Components

Return Air Temperature Sensor

The unit is equipped with a return air temperature sensor to monitor the space temperature when the unit is in stand alone mode. The return air sensor is located in the upper part of the return opening in such a way that it is exposed to the entering airstream. An alarm signal will be sent to the LC controller if the return air temperature sensor is disconnected. The temperature is measured with a 10k ohm NTC thermistor.

This sensor can be verified and adjusted by:

1. Press MENU key to go to the Main Menu screen.
2. Press UP or DOWN keys and ENTER key to enter TECHNICIAN password 1313.
3. Press UP or DOWN keys to scroll to **I/O Config**; press ENTER key.
4. Press UP or DOWN keys to scroll to **Return Air Sensor (C5)**; press ENTER key.
5. Verify the measurement displayed on screen is accurate (see Figure 21).



6. If the measurement needs to be adjusted, apply an offset value by pressing ENTER to scroll to **Offset**.
7. Press UP or DOWN keys to adjust the offset.

8. The update will not take effect until the cursor is moved out of the **Offset** parameter.
9. Once adjusted, press the ESCAPE key several times to return to Main Menu screen.

Return Air Temperature Alarm

When the return air temperature sensor value is out of range (-41.0 to 303.0°F), the controller will generate a sensor failure alarm to indicate the sensor is not working properly.

This alarm is fixed and cannot be adjusted.

Temperature/Humidity Control Operation

The unit utilizes a PID control loop for space control. This control will compare the space temperature to the space setpoint. Based on how far away from the setpoint the temperature is, the loop will output a cooling or heating capacity number between 0 and 100%. The unit will then take all of the available cooling methods and distribute them evenly across the 0-100% range. The stages are then brought on as the heating or cooling capacity reaches the percentage that brings the stages on or off. There are separate setpoints for cooling and heating.

To change or view the unit setpoint:

1. From the Status screen, press UP or DOWN key until Quick Menu displays Setpoints icon (). Press ENTER key.
2. Press ENTER key to scroll to **Cool Setpoint** or **Heat Setpoint** (see Figure 4 on page 8).
3. Press UP or DOWN keys to change the value to desired heating and/or cooling setpoint.

Cooling

The unit is equipped with 1 stage of freecooling and 2 stages of mechanical cooling (compressor and solenoid) for a total of 3 cooling stages (see Figure 22).

Cooling w/No Economizer

The unit is equipped with 1 stage of freecooling and 2 stages of mechanical cooling (compressor and solenoid). However, the outdoor conditions are not favorable for economizer operation so there are a total of 2 cooling stages (see Figure 23).

Heating

The unit is equipped with 1 stage of electric heat (see Figure 24).

Staging

The unit will stage the cooling components based on the cooling demand referenced in the temperature control. The unit will stage the economizer on first if the indoor and outdoor conditions are favorable. The compressor stage 1 will be enabled next as the demand increases. Finally, the compressor stage 2 will be enabled as the demand continues to increase.

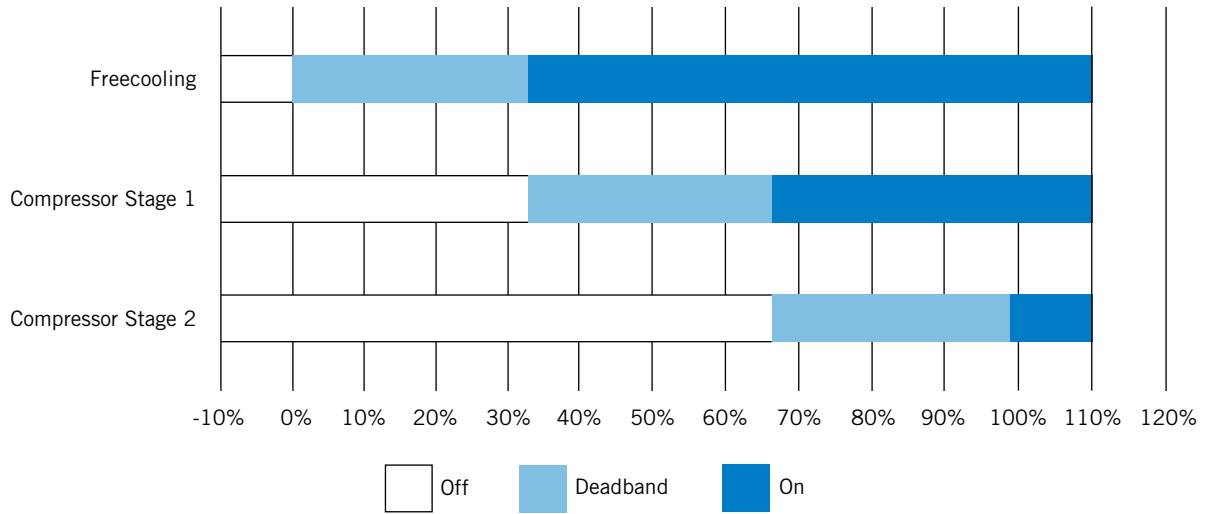

Deadband (sometimes called a neutral zone or dead zone) is an interval of a signal domain or band where no action occurs

FIGURE 23
Cooling w/No Economizer

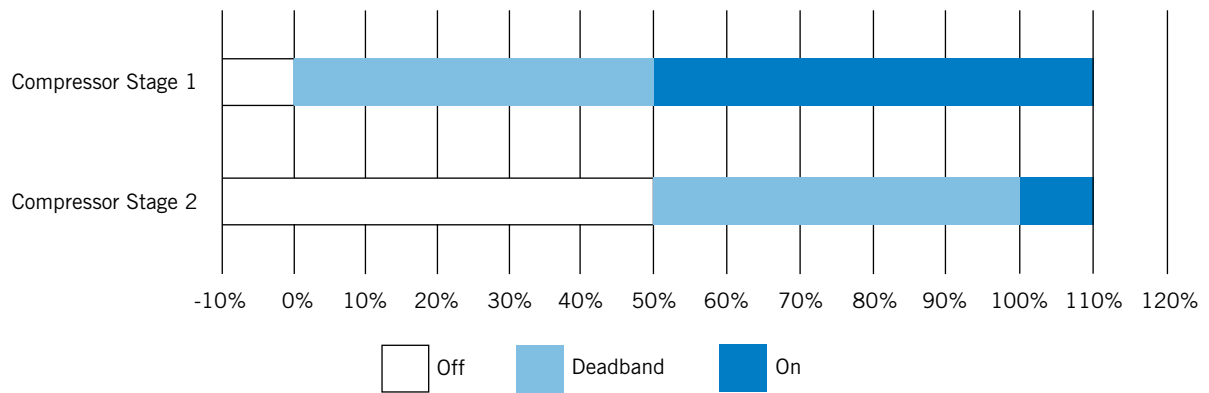

Deadband (sometimes called a neutral zone or dead zone) is an interval of a signal domain or band where no action occurs

FIGURE 24
Heating

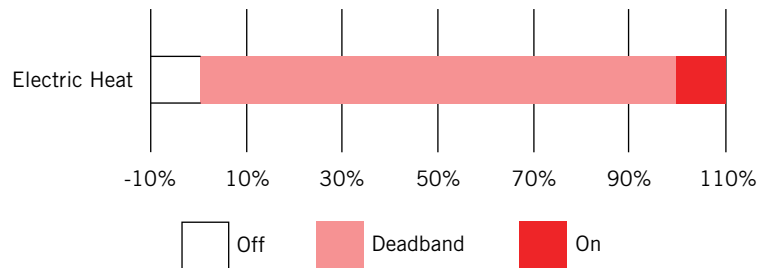

Deadband (sometimes called a neutral zone or dead zone) is an interval of a signal domain or band where no action occurs

The unit is only equipped with one stage of heat and will turn on based on the heating demand.

To view unit stages:

1. From the Status screen, press UP or DOWN key until Quick Menu displays Unit Information icon (). Press ENTER key.
2. The cooling and heating demand are visible on this screen. The unit stages will display here when active as FC, CL1, CL2 or H1 (see Figure 25).

FIGURE 25
Viewing Unit Stages



Dehumidification

The unit uses a dehumidification sequence that does not require the electric heat to run at the same time as the compressor. Instead, the unit will turn on the compressor to cool down to the heating setpoint. Once the lower setpoint has been reached, the unit will heat the space back up to the upper setpoint. This cycle continues until the humidity level in the shelter reaches an acceptable level. At this point, the unit will revert back to normal operation. The economizer will also be disabled while the unit is in the dehumidification mode.

NOTE: This feature is dependent upon the LC6000 indoor humidity sensors and a command from the LC to enter dehumidification mode. See the latest revision of LC6000 Service Instructions 2100-669 for adjustment of the dehumidification setpoint and differentials.

Electronic Expansion Valve (EEV)

EEV Components

Electronic Expansion Valve

The electronic expansion valve is a stepper motor that is controlled with a step output from the controller. The valve is capable of 480 steps represented by a 0-100% signal on the controller. The motor drives a needle valve that regulates the flow of refrigerant.

Suction Pressure Transducer

The unit has a pressure transducer installed on the suction line between the evaporator coil and compressor. The transducer is used for system monitoring of suction system pressures. The sensor is used with the suction temperature sensor to provide a real time superheat calculation that determines the EEV position.

This sensor can be verified and adjusted by:

1. Press MENU key to go to the Main Menu screen.
2. Press UP or DOWN keys and ENTER key to enter TECHNICIAN password 1313.
3. Press UP or DOWN keys to scroll to **I/O Config**; press ENTER key.
4. Press UP or DOWN keys to scroll to **Suction Pr Sensor (C11)**; press ENTER key.
5. Verify the measurement displayed on screen is accurate (see Figure 26).
6. If the measurement needs to be adjusted, apply an offset value by pressing ENTER to scroll to **Offset**.
7. Press UP or DOWN keys to adjust the offset.
8. The update will not take effect until the cursor is moved out of the **Offset** parameter.
9. Once adjusted, press the ESCAPE key several times to return to Main Menu screen.

FIGURE 26
Adjusting Suction Sensor/Transducer Pressure Values

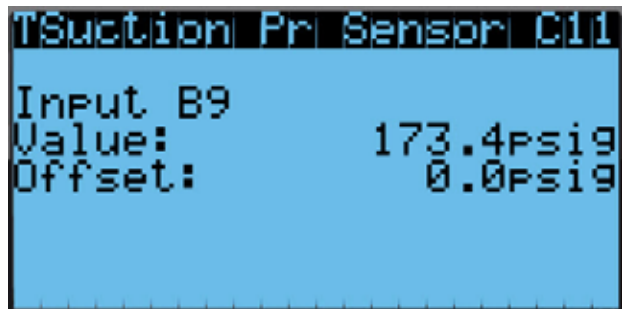

Troubleshooting the Suction Pressure Transducer

0-250 psig

-5v Nominal .5 – 4.5v Actual

4v/250 psig = .016 volts per 1 psig

Example: 125 psig x .016 + .5 volts = 2.5 volts

Formula for Tech:

Measured Pressure x .016 + Sensor Offset = Expected Transducer Signal Voltage (see Figure 27).

FIGURE 27
Voltage to Pressure: Suction Pressure Transducer

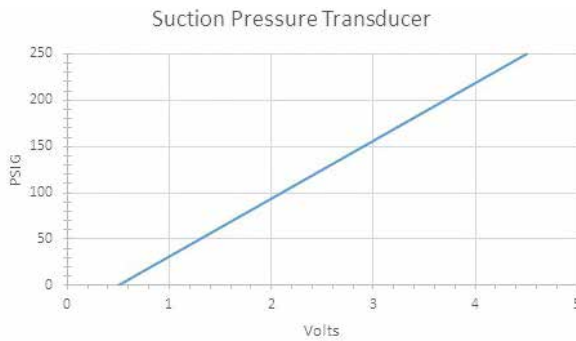

Suction Pressure Alarm

When the suction pressure transducer value is out of range (0-250 PSIG), the controller will generate a sensor failure alarm to indicate the sensor is not working properly.

This alarm cannot be adjusted.

Alarm index numbers: 141, 142, 143, 144

Suction Temperature Sensor

The suction temperature sensor is used to calculate superheat. The EEV uses this value to control the EEV. The temperature is measured with a 10k ohm NTC thermistor.

The suction temperature sensor measurement can be verified and adjusted by:

1. Press MENU key to go to the Main Menu screen.
2. Press UP or DOWN keys and ENTER key to enter TECHNICIAN password 1313.
3. Press UP or DOWN keys to scroll to **I/O Config**; press ENTER key.
4. Press UP or DOWN keys to scroll to **Suct Temp Sensor (C9)**; press ENTER key.
5. Verify the measurement displayed on screen is accurate (see Figure 28).

FIGURE 28
Adjusting Suction Temperature Sensor Values

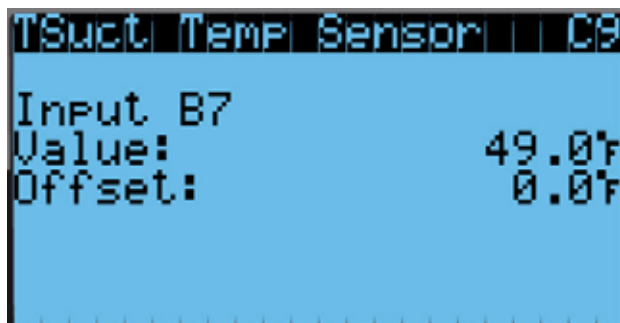

6. If the measurement needs to be adjusted, apply an offset value by pressing ENTER to scroll to **Offset**.
7. Press UP or DOWN keys to adjust the offset.
8. The update will not take effect until the cursor is moved out of the **Offset** parameter.

Suction Temperature Alarm

When the suction temperature sensor value is out of range (-41.0 to 303.0°F), the controller will generate a sensor failure alarm to indicate the sensor is not working properly.

This alarm cannot be adjusted.

Alarm index numbers: 137, 138, 139, 140

Evaporator Freeze Condition Alarm

The FUSION-TEC Freeze alarm (Evaporator Coil Freeze Protection) uses the suction temperature sensor to alarm and manage operation when conditions are favorable for an evaporator coil freeze condition. Whenever the compressor is running, the system will constantly monitor the suction line temperature. If the suction line temperature falls below the freeze setpoint (33°F factory default) for a period of time exceeding freeze alarm delay time (180 seconds factory default), the system will alarm a freeze condition. Once a freeze condition is triggered, the system will stop the compressor operation and increase the blower speed to 80% in order to rapidly warm and thaw the evaporator coil. After a period of 5 minutes has elapsed, normal operation will continue.

To adjust the freeze setpoint and/or alarm delay time:

1. Press MENU key to go to the Main Menu screen.
2. Press UP or DOWN keys and ENTER key to enter USER password 2000.
3. Press UP or DOWN keys to scroll to **System Config**; press ENTER key.
4. Press UP or DOWN keys to scroll to **Alarm Setup (A7)**; press ENTER key.
5. Press ENTER key to scroll to **Freeze Setpoint** (see Figure 29).

FIGURE 29
Adjusting Freeze Setpoint and Alarm Delay

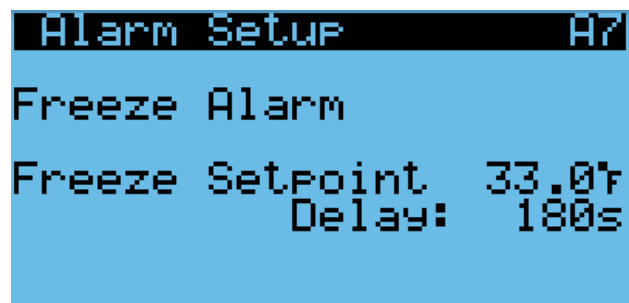

6. Press UP or DOWN keys to change to the desired value.
7. Press ENTER key to save the value/scroll to **Delay**.
8. Press UP or DOWN keys to change to the desired **Delay** value.
9. Press ENTER key to save the value.

EEV Operation

EEV Superheat Control

The electronic expansion valve (EEV) will open or close to maintain 10° of superheat while the compressor is running. When the compressor is not running, the valve will close.

Low superheat protection will be active once the superheat value is at or below 5°F. At this point, the control will aggressively close the valve so that superheat is maintained.

EEV Instructions for Vacuum, Reclaim, Charge Unit

The electronic expansion valve moves to the 20% open position when the unit is not actively cooling. The valve may need to be manually positioned for service or troubleshooting. The valve can be positioned by using a menu override.

To manually override the valve:

NOTE: *The unit must be off to perform this override.*

1. Press MENU key to go to the Main Menu screen.
2. Press UP or DOWN keys and ENTER key to enter TECHNICIAN password 1313.
3. Press UP or DOWN keys to scroll to **I/O Config**; press ENTER key.
4. Press UP or DOWN keys to scroll to **TEEV Service (C16)**; press ENTER key.

5. Press ENTER key to scroll to **Enable** (see Figure 30).
6. Press UP or DOWN key to change **Disable** to **Enable**.
7. Press ENTER key to scroll to **Position**.
8. Press UP or DOWN keys to adjust to the desired value.
9. Press ENTER key to save.

FIGURE 30
Overriding EEV Output

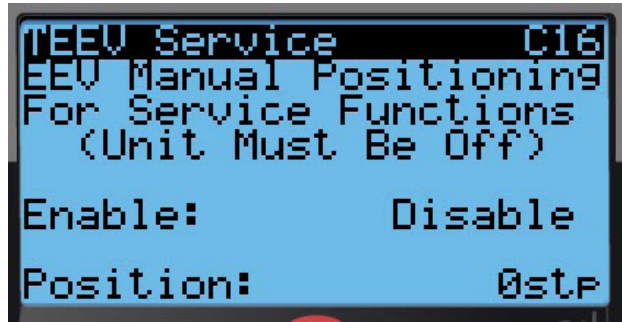

The valve can also be opened or closed using the EEV service tool (Bard Part # 2151-021). This magnetic EEV service tool (shown in Figure 31) is used to manually open the EEV. To do this, remove the EEV stator coil (red color with retaining nut on top), slide the magnetic tool over the shaft where the stator was removed and turn in a clockwise direction to open the valve to the full open position (directional arrows are provided on the tool). Opening the valve to the full open position will aid in the refrigerant reclamation and evacuation processes.

With the stator removed, the resistance should be 40 ohms +/- 10%. There are two sets of three wires that will have this resistance.

FIGURE 31
Electronic Expansion Valve (EEV) and Service Tool

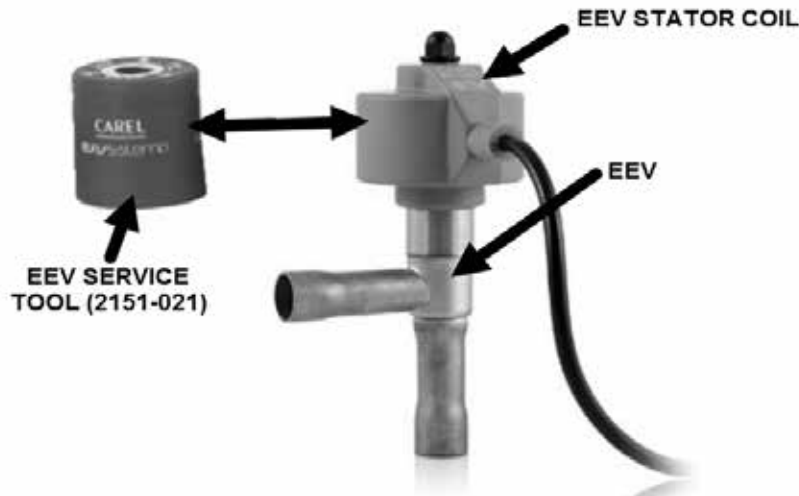

Reapply the EEV stator coil and retaining nut. Upon powering the unit back up, the control board will automatically drive the EEV back to the fully shut position, and then back to the 20% open position prior to starting the compressor back up. Once the compressor starts, the control board will again modulate the EEV position to control the system superheat.

System Pressures

To view system pressure and temperatures during this process:

1. From the Status screen, press UP or DOWN key until Quick Menu displays Unit Information icon (). Press ENTER key.
2. Press UP or DOWN keys to scroll to **EEV 1 Circuit** and **EVD 1 Compressor** screens.
3. Reference the **Pressures** and **Temperatures** on **EVD 1 Compressor** and the **Superheat** and **Subcooling** on **EEV 1 Circuit**.

Additional EEV Alarms

Low Superheat Alarm

This alarm will become active when the calculated superheat goes below 5°F. This alarm will clear itself when the condition is no longer present.

This alarm cannot be adjusted.

Indoor Airflow

Indoor Airflow Components

Blower

The unit is equipped with a blower that is driven by an electronically commutated motor (ECM). This blower is controlled by a 0-10v signal provided from the controller. This 0-10v signal is converted to a PWM signal with an adapter. The blowers on both the WR36AP* and WR58AP* models use a 10" diameter wheel. The WR36AP* operates between 250-850 rpm while the WR58AP* operates between 250-1400 rpm.

The blower output can be put into an override mode for verification or troubleshooting.

To put the blower into override:

1. Press MENU key to go to the Main Menu screen.
2. Press UP or DOWN keys and ENTER key to enter TECHNICIAN password 1313.
3. Press UP or DOWN keys to scroll to **I/O Config**; press ENTER key.
4. Press UP or DOWN keys to scroll to **Blower Fan (C13)**; press ENTER key.
5. Press ENTER key to scroll to **Blower OV Speed** (see Figure 32).

6. Press UP or DOWN keys to adjust the speed to the desired output. See Table 3A (below) or 3B (on page 20).
7. Press ENTER key to scroll to **Override**.
8. Press UP or DOWN key to change **Disabled** to **Enabled**.
9. Press ENTER key to save.

FIGURE 32
Putting Blower Output into Override Mode



TABLE 3A
WR36AP* Blower Speeds

Mode	Speed Percentage	Controller Output Volts	CFM
Freezestat Active	94.0	9.4 v	1500
High Sensible Full Load Cooling	94.0	9.4 v	1500
High Sensible Part Load Cooling	54.0	5.4 v	1100
Standard Full Load Cooling	63.0	6.3 v	1200
Standard Part Load Cooling	43.0	4.3 v	950
Economizer Speed	63.0	6.3 v	1200
Heating	63.0	6.3 v	1200
Dehumidification Mode	19.0	1.9 v	470

TABLE 3B
WR58AP* Blower Speeds

Mode	Speed Percentage	Controller Output Volts	CFM
Freezestat Active	80.0	8.0 v	2260
High Sensible Full Load Cooling	75.0	7.5 v	2180
High Sensible Part Load Cooling	50.0	5.0 v	1705
Standard Full Load Cooling	55.0	5.5 v	1830
Standard Part Load Cooling	35.0	3.5 v	1335
Economizer Speed	45.0	4.5 v	1600
Heating	35.0	3.5 v	1335
Dehumidification Mode	35.0	3.5 v	1335

TABLE 4
Rated Airflow

	Nominal Rated CFM		Nominal Rated ESP
	High	Low	
WR36AP*	1200	950	0.00
WR58AP*	1800	1400	0.10

TABLE 5
Indoor Blower Performance

	Speed	High		Low	
	ESP (Inch H ₂ O)	Dry Coil	Wet Coil	Dry Coil	Wet Coil
WR36AP*	0.00	1260	1200	995	950
WR58AP*	0.10	1885	1800	1470	1400

TABLE 6
Maximum ESP of Operation
Electric Heat Only

Model	Static Pressure*
-A0Z	.00"
-A05	.00"
-B0Z	.00"
-B06	.00"

* Unit is rated for free blow non-ducted operation with SGR-5W Supply Grille and RGR-5W Return Grille.

Blower Status Alarm

If the blower is commanded on and the fan status switch (differential pressure) has not indicated the fan is running within 45 seconds, the system will generate an alarm.

This alarm is just a notification and will clear itself when the conditions are no longer present.

To adjust the air flow alarm delay:

1. Press MENU key to go to the Main Menu screen.
2. Press UP or DOWN keys and ENTER key to enter USER password 2000.
3. Press UP or DOWN keys to scroll to **System Config**; press ENTER key.
4. Press UP or DOWN keys to scroll to **Alarm Setup (A8)**; press ENTER key.
5. Press ENTER key to scroll to **Air Flow Alarm Del** (see Figure 33).
6. Press UP or DOWN keys to change to the desired value.
7. Press ENTER key to save the value.

FIGURE 33
Adjusting Air Flow Alarm Delay

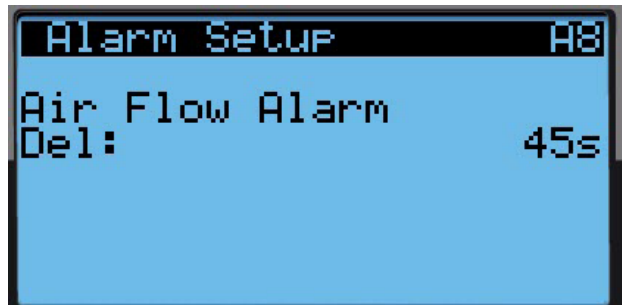

Differential Airflow Switch

The unit is equipped with a differential pressure airflow switch to monitor the blower (see Figure 34). If the blower is turned on and the switch doesn't close to indicate there is differential pressure between the inlet and outlet of the blower, an alarm will be generated. For switch settings, see Figure 34.

Differential airflow status can be viewed by:

1. Press MENU key to go to the Main Menu screen.
2. Press UP or DOWN keys and ENTER key to enter TECHNICIAN password 1313.
3. Press UP or DOWN keys to scroll to **I/O Config**; press ENTER key.
4. Press UP or DOWN keys to scroll to **Digital In Config (C2)**; press ENTER key.
5. Reference **7 NoAir** row and **Val** column (see Figure 35).

FIGURE 34
Dirty Filter Switch and Blower Status Switch

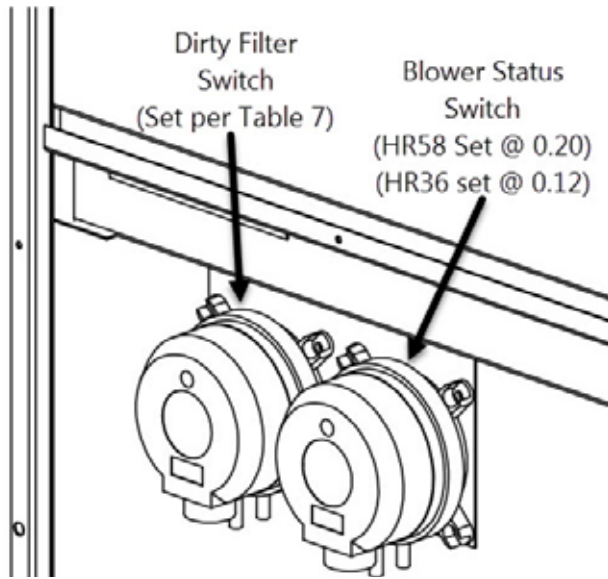
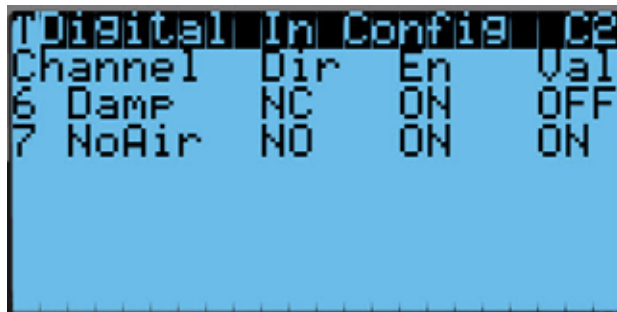

FIGURE 35
Verifying Differential Airflow Status



Filters

The unit is equipped with two (2) 20" x 30" x 2" MERV 8 filters. The filters slide into position making them easy to service. The filters can be serviced from the outside by removing either the right or left filter access panel.

Dirty Filter Switch

These units are equipped with a differential pressure switch to indicate when the filter(s) needs to be replaced (see Figure 34). The dirty filter switch measures the pressure difference across the filter through silicone tubing routed to the blower and vent areas of the unit.

The switch circuit consists of a *normally open* filter pressure switch. The switch will open when the pressure differential goes above the setting indicated on the dial. When the pressure difference returns below the setting on the dial, the switch will close.

Adjustment of dirty filter switch may be necessary to ensure proper operation. See Table 7 and Figure 36 on page 22 to aid in setting the filter switch to operate at different percentages of filter blockage.

Dirty Filter Alarm

The wall-mount unit is equipped with a differential pressure switch input to the controller. When the switch indicates a dirty filter, the controller will generate an alarm. Once the condition is no longer present, the alarm will automatically clear. Additionally, an indicator light will be turned on with the alarm and turned off when the alarm clears.

The threshold of this alarm is adjusted by changing the settings on the switch (see Table 7).

TABLE 7
Filter Switch Pressure Settings

Unit	Filter Blockage %	0%	10%	20%	30%	40%	50%	60%	70%
WR36AP* (Default) High S/T	Switch Static Setting	0.12	0.12	0.12	0.20	0.20	0.35	0.35	0.40
	Evaporator Airflow %	100%	99.3%	99.4%	98.7%	96.5%	92.1%	91.3%	87.9%
WR36AP* Standard Airflow	Switch Static Setting	0.12	0.12	0.12	0.12	0.20	0.20	0.20	0.30
	Evaporator Airflow %	100%	99.3%	99.4%	98.8%	97.3%	91.5%	89.8%	88.3%
WR58AP* (Default) High S/T	Switch Static Setting	0.40	0.50	0.60	0.70	0.75	0.80	0.90	1.00
	Evaporator Airflow %	100%	98.7%	98.1%	97.5%	91.7%	81.3%	79.1%	78.6%
WR58AP* Standard Airflow	Switch Static Setting	0.30	0.35	0.40	0.45	0.50	0.65	0.70	0.90
	Evaporator Airflow %	100%	99.8%	99%	98.5%	96.8%	89.9%	84%	82.2%

All units tested equipped with MERV 8 filters. Appropriate supply (SG) and return (RG) grilles installed during testing. Pressure switch adjustment may be necessary due to variations in filter type, installation and room pressure.

Bard recommends filter switch be set at 50% filter blockage or less. Higher settings may significantly hinder unit performance.

FIGURE 36
Dirty Filter Switch and Filter Indicator Light

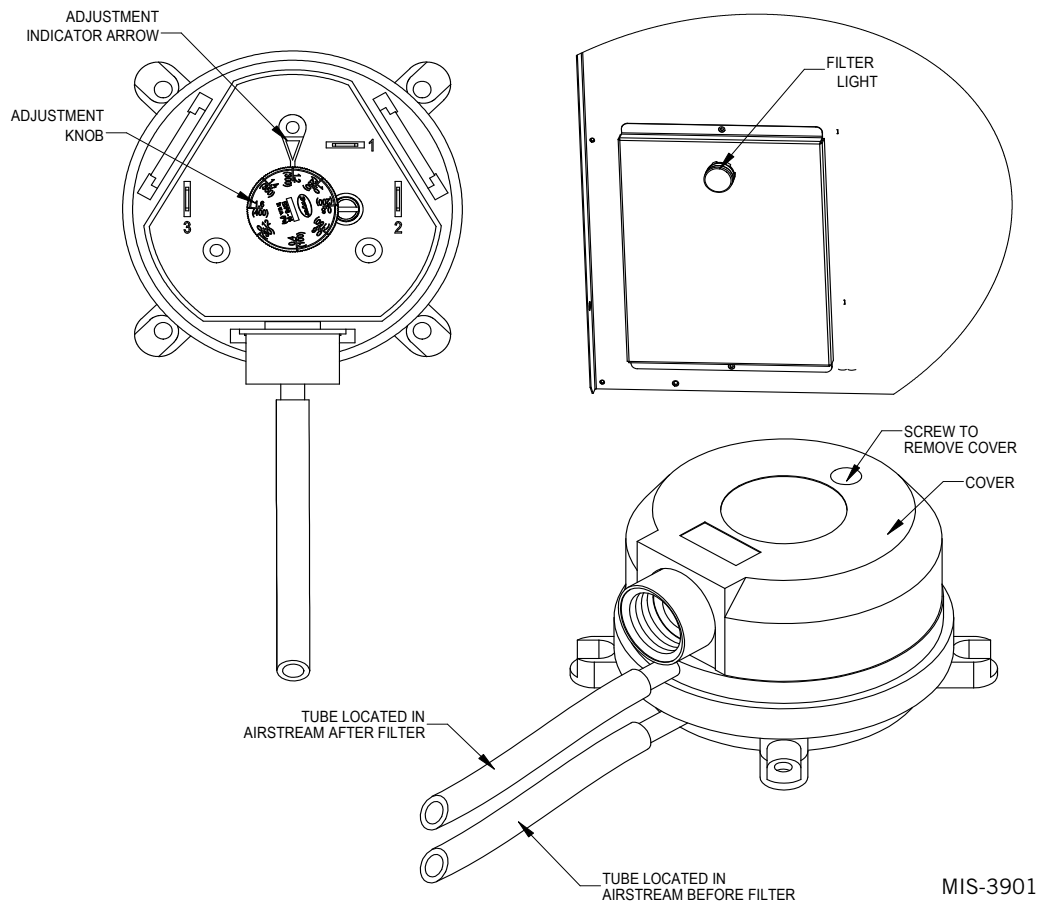

Filter Indicator Light

These units are equipped with a 24v indicator light mounted on side of unit that displays the current status of the filter (see Figure 36). When the light is on, the filter needs to be replaced. Once the filter(s) has been changed, the indicator light will turn off.

Freezestat

Earlier units were equipped with a switch that monitored the temperature of the refrigerant line leaving the evaporator coil. To prevent the coil from freezing and potentially allowing liquid refrigerant from the evaporator to enter the compressor, the freezestat switch was designed to open when the temperature at this sensor is between 26.5°F and 37.5°F and close again when the temperature is between 49.5°F and 64.5°F. This switch was used in units running software version 1.0.4 and earlier and has been removed. The evaporator coil freeze protection alarm is now calculated using system temperatures (see **Evaporator Freeze Condition Alarm** on page 17).

Indoor Airflow Operation

Blower Speed Control

The blower is capable of changing speeds to best match the requirements of the system depending on which mode the system is in (see Table 3A or Table 3B on pages 19 and 20).

The unit will automatically switch to the required speed for each mode. High sensible mode and dehumidification mode are both communicated separately from the LC. For more information on the high sensible command from LC, please see LC6000 Service Instructions 2100-669.

Additional Indoor Airflow Alarms

Supply Air Temperature Alarm

When the supply air temperature sensor value is out of range (-41.0 to 303.0°F), the controller will generate a sensor failure alarm to indicate the sensor is not working properly.

This alarm is fixed and cannot be adjusted.

Condenser Fan

Condenser Fan Components

Condenser Fan

The unit is equipped with a condenser fan that is driven by an electronically commutated motor (ECM). This fan is controlled by a 0-10v signal provided from the controller. The fan operates between 100-1200 rpm.

To view the output of the condenser fan:

1. Press MENU key to go to the Main Menu screen.
2. Press UP or DOWN keys and ENTER key to enter TECHNICIAN password 1313.
3. Press UP or DOWN keys to scroll to **I/O Config**; press ENTER key.
4. Press UP or DOWN keys to scroll to **Condenser Fan (C15)**; press ENTER key.
5. Reference **Fan Speed** parameter for the current output to the condenser fan (see Figure 37).

FIGURE 37
Verifying Condenser Fan Output

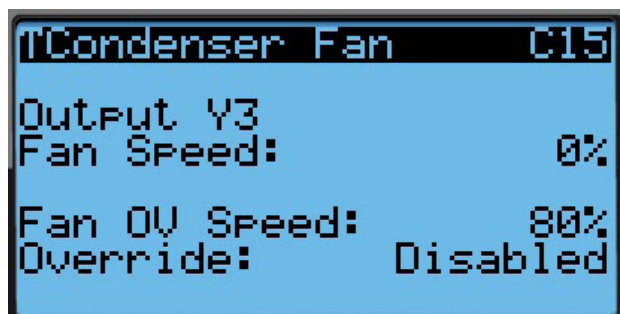

If required, the condenser fan output can be manually set for 5 minutes for troubleshooting purposes.

While looking at **Condenser Fan (C15)** screen:

1. Press ENTER key to scroll to **Fan OV Speed** (see Figure 36).
2. Press UP or DOWN keys to change the value to the desired override speed.
3. Press ENTER key to save the value and move cursor to the **Override** parameter.
4. Press UP or DOWN keys to change the value from **Disabled** to **Enabled**.
5. The fan should now run at the selected speed. The output can be verified by again referencing the **Fan Speed** parameter.

The override will last for 5 minutes or until the **Override** parameter is set to **Disabled** again.

Due to design considerations of the condenser section of the wall-mount unit, placement/clearance of the motor/fan blade is critical to heat dispersal. Should a

change of motor or fan blade be necessary, see Figure 38 for proper clearance adjustment.

FIGURE 38
Fan Blade Setting

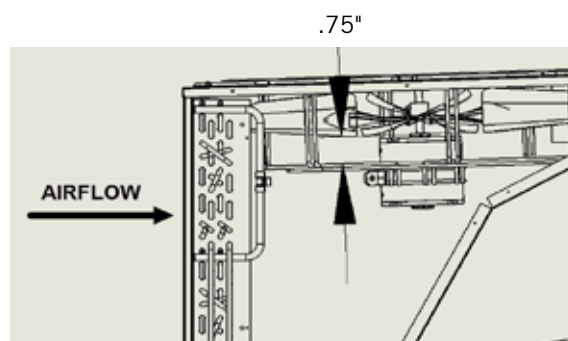

Liquid Line Pressure Transducer

The unit has a pressure transducer installed on the liquid line between the condenser and electronic expansion valve (EEV). The transducer is used for system monitoring of the liquid side system pressures. This information is used to indicate when outdoor coil cleaning is necessary based on outdoor conditions and system pressures. The sensor is also used to adapt the condenser fan speed for high and low ambient conditions. The liquid line transducer is also referred to as the discharge pressure sensor.

The discharge pressure sensor input can be verified and adjusted by:

1. Press MENU key to go to the Main Menu screen.
2. Press UP or DOWN keys and ENTER key to enter TECHNICIAN password 1313.
3. Press UP or DOWN keys to scroll to **I/O Config**; press ENTER key.
4. Press UP or DOWN keys to scroll to **Disch Pr Sensor (C10)**; press ENTER key.
5. Verify the measurement displayed on screen is accurate (see Figure 39).

FIGURE 39
Adjusting Discharge/Liquid Transducer Pressure Values



- If the measurement needs to be adjusted, apply an offset value by pressing the ENTER key to scroll to **Offset**.
- Press UP or DOWN keys to adjust the offset. The update will not take effect until the cursor is moved out of the offset parameter.
- Once adjusted, the ESCAPE key several times to return to Main Menu screen.

Troubleshooting the Discharge/Liquid Pressure Transducer

0-650 psig

0-5v

4v/650 psig = .00615 volts per 1 psig

Example: 325 psig x .00615 + .5 v = 2.5 volts

Formula for Tech:

Measured Pressure x .00615 + Sensor Offset = Expected Transducer Signal Voltage (see Figure 40).

FIGURE 40
Voltage to Pressure:
Discharge/Liquid Pressure Transducer

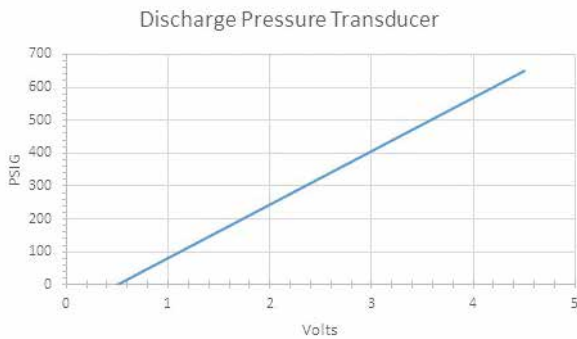

Discharge/Liquid Pressure Transducer Alarm

When the discharge pressure sensor value is out of range (0-650 PSIG), the controller will generate a sensor failure alarm to indicate the sensor is not working properly.

This alarm is fixed and cannot be adjusted.

Alarm index numbers: 153, 154, 155, 156

Liquid Temperature Sensor

The unit is equipped with a liquid line temperature sensor to monitor the temperature of the liquid refrigerant leaving the condenser and entering the EEV. The temperature is measured with a 10k ohm NTC thermistor.

The liquid temperature sensor can be verified and adjusted by:

- Press MENU key to go to the Main Menu screen.
- Press UP or DOWN keys and ENTER key to enter TECHNICIAN password 1313.
- Press UP or DOWN keys to scroll to **I/O Config**; press ENTER key.
- Press UP or DOWN keys to scroll to **Disch Temp Sensor (C3)**; press ENTER key.
- Reference the **Value** to verify the temperature (see Figure 41).
- If an offset needs to be applied, press ENTER key to scroll to **Offset**.
- Press UP or DOWN keys to change the offset to desired value.
- Press ENTER key to save.
- Press ESCAPE key several times to return to Main Menu screen.

FIGURE 41
Adjusting Discharge/Liquid Temperature Input

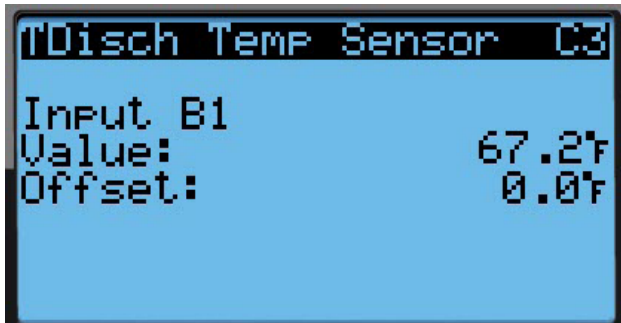

Condenser Fan Operation

Condenser Fan Speed Control

Mechanical Cooling Only

The condenser fan motor speed is selected based on outdoor air temperature. Above 80°F, the fan speed will be set to a nominal output speed. Below 80°F, the condenser fan speed will operate at reduced speeds based on outdoor air temperatures until the slowest fan speed is reached. This operation allows for more stable head pressures at lower ambient conditions, which also allows for increased unit efficiency. See Figure 42 for more detail.

NOTE: *If the outdoor temperature sensor fails, the condenser fan speed will be set to the nominal operating speed.*

FIGURE 42
Condenser Fan Speed Control

Condenser Fan Output @ Ambient Outdoor Temperature

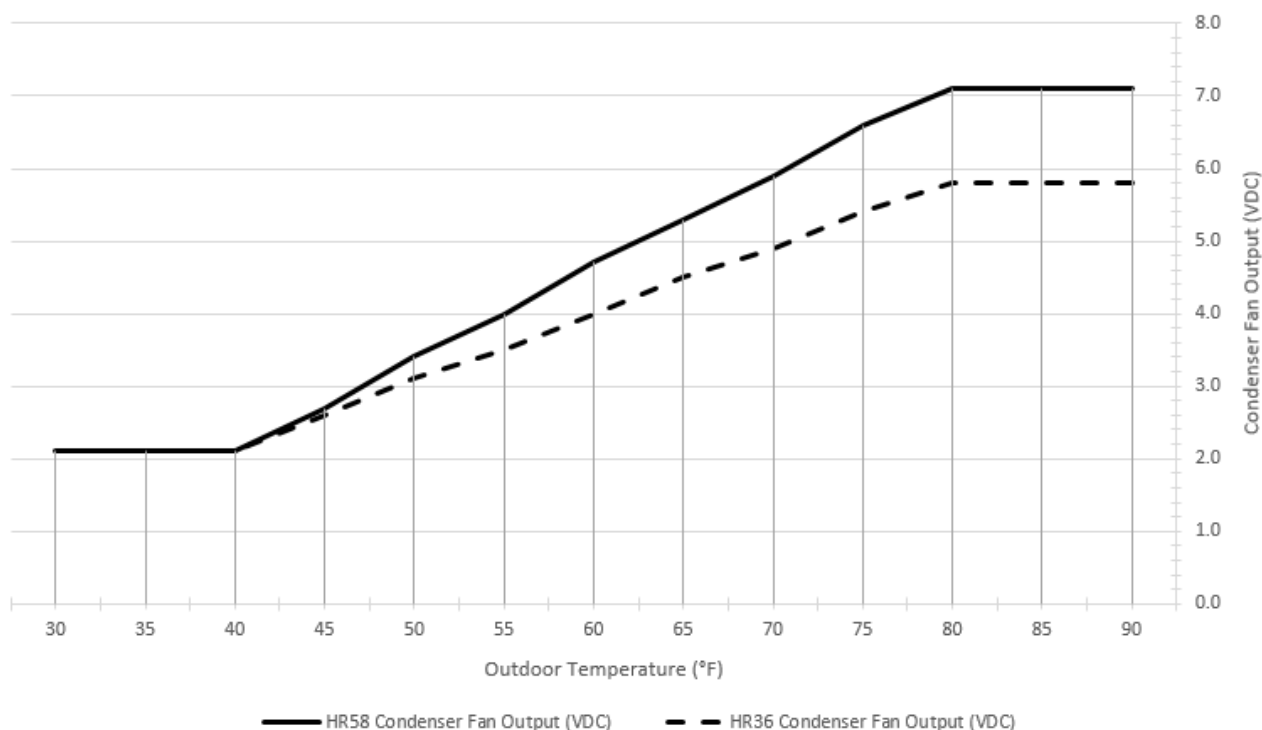

Optimized Cooling (Concurrent Economizer and Mechanical Cooling)

The condenser fan motor speed will be set to the normal operating speed and will not change based on outdoor air conditions. During optimized cooling, all fan speed control will be handled by the low ambient controls and high pressure controls if system pressures were to get out of range.

High Pressure Control

Condenser Fan Speed

When the liquid pressure reaches 590 PSI, the condenser fan will begin to speed up to attempt to bring the pressure back down. The speed will continue to ramp up until the liquid pressure reaches 630 PSI. At this point, the fan will be operating at full speed, moving as much air as possible.

Second Stage Drop Out

If the liquid pressure reaches 620 PSI, the second stage of cooling will be disabled for 2 minutes to reduce the required condenser airflow. After 2 minutes, if the pressure is less than the pressure cutout, it will resume stage 2 operation.

Low Ambient Control

At low ambient outdoor air temperatures, the fan motor will cycle as a means of controlling the system's head pressure to protect the system from evaporator coil freeze conditions. The process for this system is as follows: If the liquid pressure falls below 250 PSI, the condenser fan will turn off. The fan will remain off while the compressor remains running, allowing the head pressure to build up. Once the liquid pressure reaches 350 PSI, the fan will then turn back on at the appropriate speed. At lower ambient outdoor temperatures, this may cycle regularly as normal operation. In some cases, in higher wind prone areas, the condenser fan may stay off for prolonged durations due to low liquid pressures.

Additional Condenser Fan Alarms

Dirty Condenser Coil Alarm

The unit will continuously monitor system conditions to determine if the condenser coil is dirty or blocked. If the system monitors three consecutive cooling cycles that indicate a dirty condenser coil, an alarm will be generated. This alarm is a notification and will automatically reset when conditions are no longer present. The end user has the ability to adjust how dirty the coil gets before an alarm is generated and how many consecutive cycles before the alarm is triggered.

To change these settings:

1. Press MENU key to go to the Main Menu screen.
2. Press UP or DOWN keys and ENTER key to enter TECHNICIAN password 1313.
3. Press UP or DOWN keys to scroll to **Adv System Config**; press ENTER key.
4. Press UP or DOWN keys to scroll to **Dirty Cond Alarm (B4)**; press ENTER key.
5. Press ENTER key to scroll to **Alarm Threshold** (see Figure 43).
6. Press UP or DOWN keys to adjust the % restriction to desired level.
7. Press ENTER key to save value and move the cursor to **Trips before alarm**.
8. Press UP or DOWN keys to change the **Trips before alarm** to the desired value.
9. Press ENTER key to save.
10. Press ESCAPE key several times to return to Main Menu screen.

Alarm index numbers: 161, 162, 163, 164

FIGURE 43
Adjusting Dirty Condenser Coil Alarm Settings

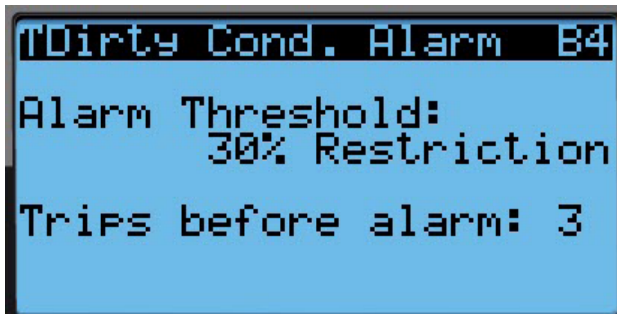

Compressor

Compressor Components

Compressor

Three Phase Scroll Compressor Start Up Information

Scroll compressors, like several other types of compressors, will only compress in one rotational direction. Direction of rotation is not an issue with single phase compressors since they will always start and run in the proper direction.

However, three phase compressors will rotate in either direction depending upon phasing of the power. Since there is a 50-50 chance of connecting power in such a way as to cause rotation in the reverse direction, verification of proper rotation must be made. Verification of proper rotation direction is made by observing that suction pressure drops and discharge pressure rises when the compressor is energized.

Reverse rotation also results in an elevated sound level over that with correct rotation, as well as substantially reduced current draw compared to tabulated values.

Verification of **proper rotation** must be made at the time the equipment is put into service. If improper rotation is corrected at this time, there will be no negative impact on the durability of the compressor. However, reverse operation for over 1 hour may have a negative impact on the bearing due to oil pump out.

NOTE: *If compressor is allowed to run in reverse rotation for an extended period of time, the compressor's internal protector will trip.*

All three phase compressors are wired identically internally. As a result, once the correct phasing is determined for a specific system or installation, connecting properly phased power leads to the same Fusite terminal should maintain proper rotation direction.

The direction of rotation of the compressor may be changed by reversing any two line connections to the wall-mount unit.

Compressor Control Module (CCM)

Delay-on-Make Timer
Short Cycle Protection/Delay-on-Break
Test Mode
High Pressure Detection
Brownout Protection with Adjustment

The LPC terminals are jumpered in this application. Instead, the low pressure transducer is used for low pressure monitoring.

Delay-on-Make Timer

In the event of power loss, a delay-on-make timer is included to be able to delay startup of the compressor. This is desired when more than one unit is on a structure so that all of the units do not start at the same time which could happen after a power loss or building shutdown. The delay-on-make time period is 2 minutes plus 10% of the delay-on-break time period. To ensure that all of the units do not start at the same time, adjust the delay-on-break timer on each unit to a slightly different delay time.

Short Cycle Protection/Delay-on-Break

An anti-short cycle timer is included to prevent short cycling the compressor. This is adjustable from 30 seconds to 5 minutes via the adjustment knob (see Figure 44). Once a compressor call is lost, the time period must expire before a new call will be initiated.

10% of this time is also considered on the delay-on-make timer (see above).

High Pressure Detection

High pressure switch monitoring allows for a lockout condition in a situation where the switch is open. If the high pressure switch opens, the CCM will de-energize the compressor. If the switch closes again,

FIGURE 44
8201-164 Compressor Control Module

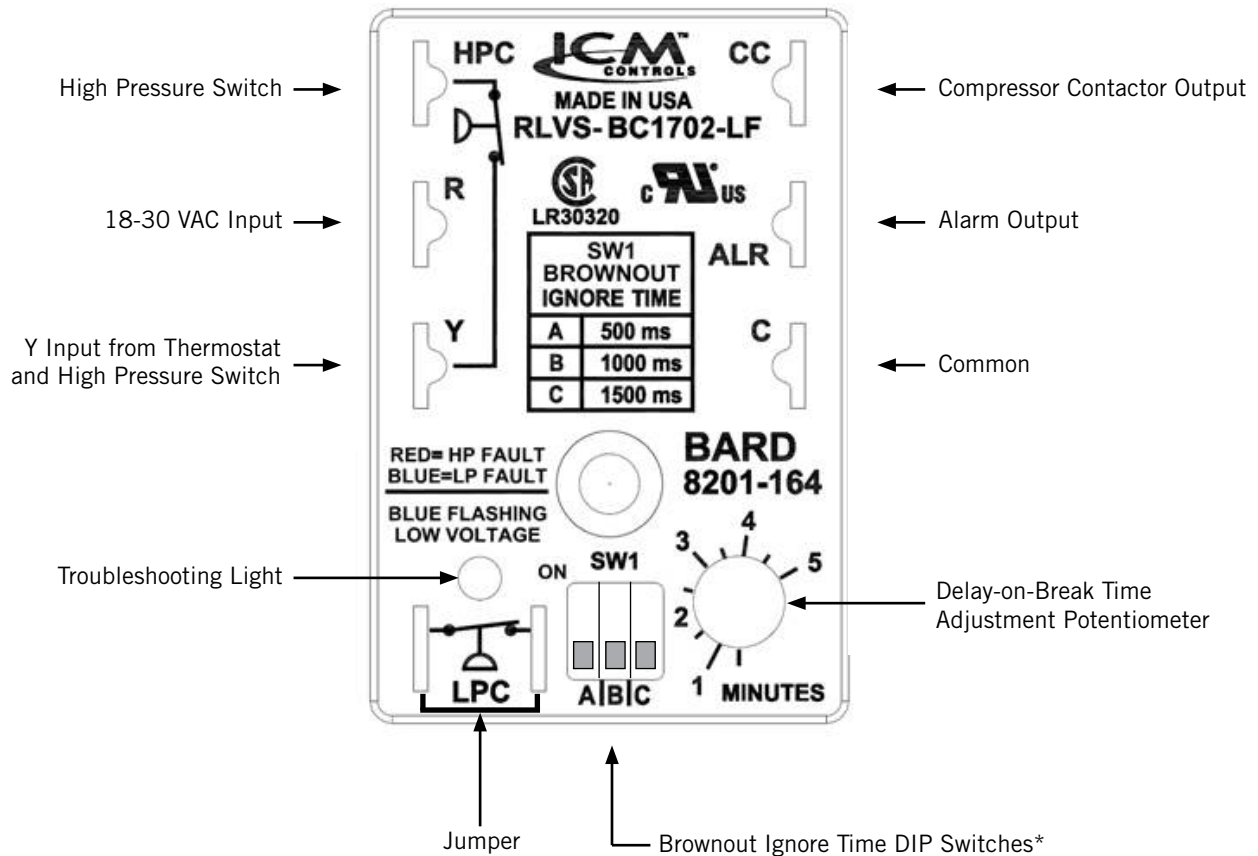

* Turn on only one switch for that specific ignore time setting

it will then restart the compressor after the delay-on-break setting has expired on the device. If the switch trips again during the same Y call, the compressor will be de-energized. The ALR terminal will be energized signalling the unit control board that a high pressure event has occurred (see **Refrigerant High Pressure Alarm** on page 28).

Test Mode

By rapidly rotating the potentiometer (POT) clockwise (see Figure 44), all timing functions will be removed for testing.

The conditions needed for the unit to enter test mode are as follows: POT must start at a time less than or equal to the 40 second mark. The POT must then be rapidly rotated to a position greater than or equal to the 280 second mark in less than ¼ second. Normal operation will resume after power on reset or after the unit has been in test mode for at least 5 minutes.

Brownout Protection with Adjustment

Brownout protection may be necessary if the utility power or generator power has inadequate power to prevent the voltage from dropping when the compressor

starts. This is rare but can happen if the generator is undersized at the site or if the site is in a remote location far from the main power grid. Under normal circumstances, allowing the brownout to be ignored for a time period should not be needed. The 8201-164 is shipped in “0” do not ignore position.

If ignoring the brownout is needed because of the above conditions, three preset timers can be set by DIP switches in order to delay signaling a power brownout for a specific length of time after compressor contactor is energized. This allows the compressor a time period to start even if the voltage has dropped and allows the voltage to recover. This delay only happens when the CC terminal energizes. The delay can be set to 500, 1000 or 1500 milliseconds; time is not cumulative—only the longest setting will apply. If the voltage recovers during the brownout time period, the compressor will start.

If the voltage doesn’t recover during the time period, the blue LED will flash. A flashing blue LED indicates that a brownout condition was sensed; the control will continue to flash the blue LED until the Y call has been satisfied. The compressor will not start if the blue LED is flashing.

If user chooses the “0” do not ignore position when the site has inadequate utility or generator power, this could lead to the compressor never starting. The control will see the brownout immediately and not start.

A common scenario and one that has been seen in the field is when a unit or units switches from utility power to generator power. With slower transfer switches, the time delay between the utility power and generator power didn't cause a problem. The units lost power, shut off and came back on line normally. With the introduction of almost instantaneous transfer switches, the millisecond long power glitch can be enough that the compressor will start to run backwards. In this scenario, the CCM will catch this and restart the units normally.

High Pressure Safety Switch

All units have a high pressure switch as a safety device. This device will open when pressure in the system reaches 650 PSIG. The sensor is directly connected to the dedicated compressor control module (see **High Pressure Detection**).

Refrigerant High Pressure Alarm

When the wall-mount unit receives a signal from the compressor control module (CCM) indicating a high pressure event, the wall-mount unit will generate an alarm. Upon receiving the alarm, the wall-mount unit will remove the “Y” call from the CCM, resetting the status of the CCM. The alarm will stay present on the wall-mount unit until manually cleared with TEC-EYE hand-held diagnostic tool.

Alarm index numbers: 21, 40, 55, 70

In addition to the CCM, the discharge pressure transducer is used to prevent a high pressure event. When the discharge pressure is above the discharge pressure alarm setpoint (set 30 pounds below high pressure switch, which is 650), the system will disable stage 2 of mechanical cooling.

Phase Monitor

Used only on three phase equipment, the phase monitor is a compressor protection device that will prohibit operation of the compressor if the device senses a possible reverse-rotation situation due to incorrect phasing. On a call for compressor (and only compressor), the device will check incoming phase, check for severe voltage imbalance and check for proper frequency. Under nominal conditions, a green LED light will show on the face of the monitor. If there is improper phasing, voltage imbalance or frequency deviation, the device will show a red LED light and prohibit compressor operation.

If a fault condition occurs, reverse two of the supply leads to the unit. **Do not reverse any of the unit factory wires as damage may occur.**

Compressor Operation

The compressor will be enabled when the unit (in stand alone mode) or LC provide a cooling stage 1 call. The compressor call from the controller has several delays that may affect the start or stop time of the compressor in regards to the cooling demand. The compressor has a minimum on time of 180 seconds to prevent short cycling the compressor. The compressor also has a minimum off time of 120 seconds to prevent start ups before the pressure in the refrigeration system equalizes. When the second stage is engaged, it also has a minimum run time of 120 seconds to allow the system to stabilize before returning to single stage or shutting down.

These delays can be changed by:

1. Press MENU key to go to the Main Menu screen.
2. Press UP or DOWN keys and ENTER key to enter TECHNICIAN password 1313.
3. Press UP or DOWN keys to scroll to **Adv System Config**; press ENTER key.
4. Press UP or DOWN keys to scroll to **Unit Config (B2)**; press ENTER key.
5. Press ENTER key to scroll to **Min On, Min Off, Min On Same, Unloader Del or Address Delay** (see Figure 45).
6. Press UP or DOWN keys to change the value.
7. Press ENTER key to save value and move the cursor to next parameter or top of screen.
8. Press ESCAPE key several times to return to Main Menu screen.

FIGURE 45
Adjusting Compressor Delays

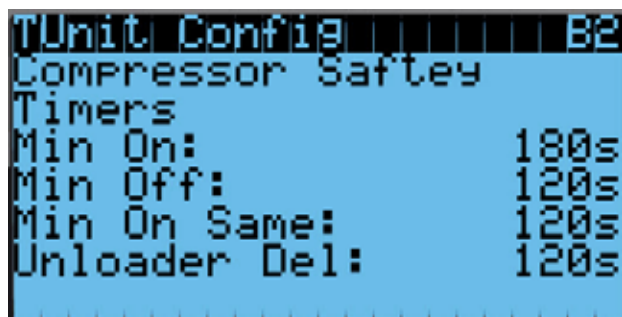

The address-based delay only applies to the wall-mount unit when in stand alone mode. The controller will delay the unit compressor based on the value entered on screen B2 multiplied by the unit address. This is intended to keep multiple units from starting their compressors at the same time when there is a quick change in the load. When connected to the LC, this is taken care of by LC logic.

Additional Compressor Alarms

Refrigerant Low Pressure Alarm

When the suction pressure transducer indicates a pressure value less than the low pressure alarm setpoint of 40 PSIG and there is an active call for cooling, the controller will disable the compressor (after a 180-second delay). **NOTE:** *The second call will be delayed based on the delay off value mentioned in the compressor section.* The controller will try to run the refrigeration system two (2) times within 900 seconds before the alarm will lock the compressor out. This alarm needs to be manually cleared before compressor operation will resume.

Alarm index numbers: 16, 35, 50, 65

To adjust the low pressure alarm settings:

1. Press MENU key to go to the Main Menu screen.
2. Press UP or DOWN keys and ENTER key to enter USER password 2000.
3. Press UP or DOWN keys to scroll to **System Config**; press ENTER key.
4. Press UP or DOWN keys to scroll to **Alarm Setup (A6)**; press ENTER key.
5. Press ENTER key to scroll to **Delay** to adjust how long the compressor waits before turning the compressor off (see Figure 46).
6. Press UP or DOWN keys to adjust the time delay.
7. Press ENTER key to scroll to **Two Count Del.**
8. Press UP or DOWN keys to adjust the delay value.
9. Press ENTER key to save.
10. Press the ESCAPE key several times to return to Main Menu screen.

FIGURE 46
Adjusting Low Pressure Alarm Settings

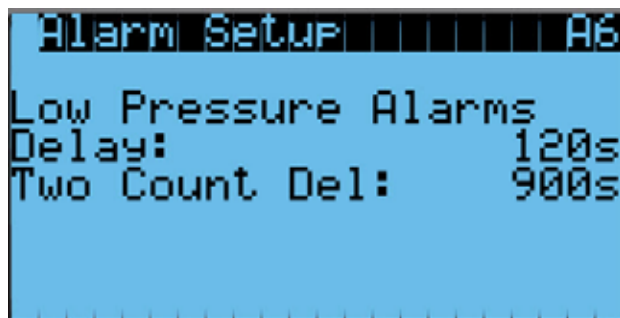

Economizer

Economizer Components

Actuator

The actuator rotates up to 90° based on a 0-10v signal sent to it by the controller. The actuator is rated at 44 lb-in and is spring return when power is lost. This component is what opens and closes the damper blade.

To verify the output from the controller to the actuator:

1. Press MENU key to go to the Main Menu screen.
2. Press UP or DOWN keys and ENTER key to enter TECHNICIAN password 1313.
3. Press UP or DOWN keys to scroll to **I/O Config**; press ENTER key.
4. Press UP or DOWN keys to scroll to **Damper Override (C14)**; press ENTER key.
5. Reference the **Damper Position** for the current output to the damper (see Figure 47).
6. To override the current position, press ENTER key to scroll to **Damper OV Pos.**
7. Press UP or DOWN keys to change the value to the desired output.
8. Press ENTER key to save the value and move cursor to **Override.**
9. Press UP or DOWN keys to change the value from **Disabled** to **Enabled.**
10. The **Damper Position** will update with the new override value and the damper will travel to that position.

NOTE: *This override will last for 5 minutes or until the Override is changed back to Disabled.*

FIGURE 47
Damper Override

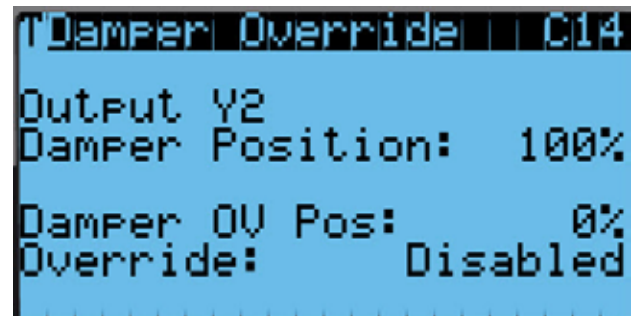

Dust Sensor

The unit has a dust sensor installed near the outdoor air inlet. The dust sensor checks for excessive particulates in the outdoor air, and will close the economizer if the dust is excessive. The sensor uses a PWM signal converted to 0-5v output to the controller.

To ensure proper performance, cleaning may be required. Vacuuming or blowing the dust off the sensor with forced air is recommended. **Avoid inserting any objects into the sensor.**

The dust sensor can be verified by:

1. Press MENU key to go to the Main Menu screen.
2. Press UP or DOWN keys and ENTER key to enter TECHNICIAN password 1313.
3. Press UP or DOWN keys to scroll to **I/O Config**; press ENTER key.
4. Press UP or DOWN keys to scroll to **Dust Sensor (C8)**; press ENTER key.
5. Reference the **Value** for the current sensor reading (see Figure 48).
6. To apply an offset to the current reading, press ENTER key to scroll to **Offset**.
7. Press UP or DOWN keys to adjust the value to the desired value.
8. Press ENTER key to save the value and move cursor to next parameter.

NOTE: The sensor can be disabled if required for troubleshooting.

9. With the cursor on the **Enable** parameter, press UP or DOWN keys to change the value from **ON** to **OFF**.
10. Press ENTER key to save.

FIGURE 48
Dust Sensor



Dust Sensor Failure Alarm

When the sensor reads a value that is outside of the acceptable 0 to 100% range, an alarm will be generated indicating the sensor has failed. This alarm is just a notification and will not disable any other features on the controller.

This alarm is fixed and cannot be adjusted.

Alarm index numbers: 149, 150, 151, 152

High Dust Limit Alarm

When dust content in the air is high and is a risk to prematurely reducing airflow through the filters,

the unit will restrict the use of the economizer. The controller has adjustable software setpoints (default to 80%) to indicate dust levels are too high and to disable the economizer operation for 5 minutes (unit default). This alarm is not communicated to the NOC. Once the conditions are no longer present, the alarm will automatically clear.

Alarm index numbers: 157, 158, 159, 160

To adjust the dust sensor alarm setpoint:

1. Press MENU key to go to the Main Menu screen.
2. Press UP or DOWN keys and ENTER key to enter USER password 2000.
3. Press UP or DOWN keys to scroll to **System Config**; press ENTER key.
4. Press UP or DOWN keys to scroll to **Alarm Setup (A9)**; press ENTER key.
5. Press ENTER key to scroll to **Setpoint** (see Figure 49).
6. Press UP or DOWN keys to change to the desired value.
7. Press ENTER key to save the value.

NOTE: When the temperature outside is measured at or below 0°F, the dust sensor alarm will be disabled to allow economizer operation. This is done because the compressor is disabled below 0°F and the system would not have the capability to cool.

FIGURE 49
Adjusting Dust Sensor Alarm Setpoint

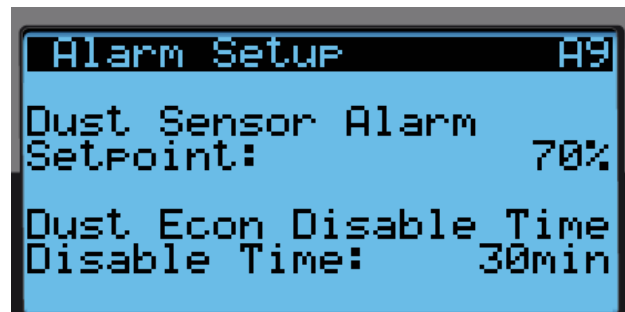

Damper Blade

The system utilizes three damper blades used to bring in outdoor air and exhaust space air for economizer operation. The damper blades are made of sheet metal and are integrated into the equipment.

Damper Switch

The economizer utilizes a magnetic switch to determine if the damper is operating correctly. This switch will be closed when the damper is closed and open when the damper is open.

To verify the status of the switch:

1. Press MENU key to go to the Main Menu screen.
2. Press UP or DOWN keys and ENTER key to enter TECHNICIAN password 1313.
3. Press UP or DOWN keys to scroll to **I/O Config**; press ENTER key.
4. Press UP or DOWN keys to scroll to **Digital In Config (C2)**; press ENTER key.
5. Reference the value located at **6 Damp** row and **Val** column (see Figure 50).
6. The input will display **ON** when the damper is closed (reflecting closed circuit on damper switch) and will display **OFF** when the damper is open (reflecting open circuit on damper switch).

FIGURE 50
Damper Switch

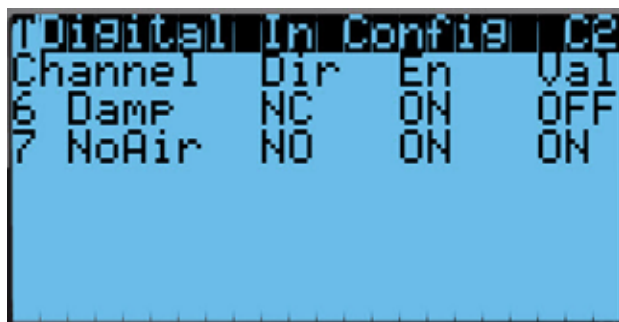

Channel	Dir	En	Val
6 Damp	NC	ON	OFF
7 NoAir	NO	ON	ON

Damper Failed to Open Alarm

When the controller commands the economizer damper actuator to a position other than 0% and the damper switch indicates the damper is not open, after a delay of 20 seconds the controller will generate a damper failed to open alarm. This alarm is just a notification and will not disable any features on the controller.

Alarm index numbers: 17, 36, 51, 66

To adjust the damper failed to open delay:

1. Press MENU key to go to the Main Menu screen.
2. Press UP or DOWN keys and ENTER key to enter USER password 2000.
3. Press UP or DOWN keys to scroll to **System Config**; press ENTER key.
4. Press UP or DOWN keys to scroll to **Alarm Setup (A4)**; press ENTER key.
5. Press ENTER key to scroll to **Open Delay** (see Figure 51).
6. Press UP or DOWN keys to change to the desired value.
7. Press ENTER key to save the value.

FIGURE 51
Adjusting Damper Alarm Delay

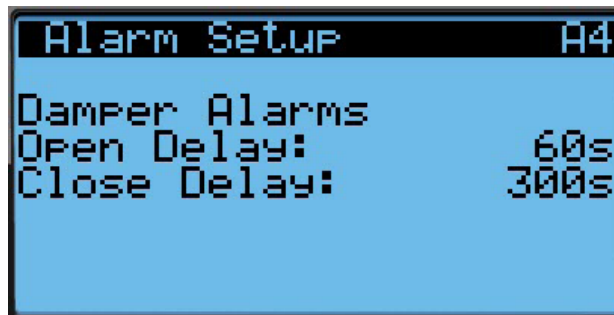

Damper Failed to Close Alarm

When the controller commands the economizer damper actuator to the 0% position and the damper switch indicates the damper is not closed, after a delay of 300 seconds the controller will generate a damper failed to close alarm. This alarm is just a notification and will not disable any features on the controller.

Alarm index numbers: 18, 37, 52, 67

To adjust the damper failed to close delay:

1. Press MENU key to go to the Main Menu screen.
2. Press UP or DOWN keys and ENTER key to enter USER password 2000.
3. Press UP or DOWN keys to scroll to **System Config**; press ENTER key.
4. Press UP or DOWN keys to scroll to **Alarm Setup (A4)**; press ENTER key.
5. Press ENTER key to scroll to **Close Delay** (see Figure 51).
6. Press UP or DOWN keys to change to the desired value.
7. Press ENTER key to save the value.

Outdoor Temperature and Humidity Combination Sensor

The unit is equipped with a combination outdoor temperature and humidity sensor to monitor outdoor conditions for the economizer operation. The temperature is measured with a 10k ohm NTC thermistor. The humidity is measured with a humidity sensor that outputs a 4-20mA signal to the controller.

The outdoor temperature can be verified by:

1. Press MENU key to go to the Main Menu screen.
2. Press UP or DOWN keys and ENTER key to enter TECHNICIAN password 1313.
3. Press UP or DOWN keys to scroll to **I/O Config**; press ENTER key.
4. Press UP or DOWN keys to scroll to **Outdoor Air Sensor (C4)**; press ENTER key.

- Reference the **Value** to see the input of the sensor (see Figure 52).

FIGURE 52
Outdoor Air Sensor

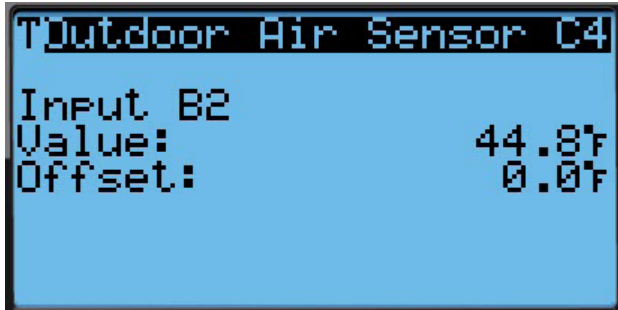

- To apply an offset, press ENTER key to scroll to **Offset**.
- Press UP or DOWN keys to change to the desired value.
- Press ENTER key to save the value.

The outdoor humidity can be verified by:

- Press MENU key to go to the Main Menu screen.
- Press UP or DOWN keys and ENTER key to enter TECHNICIAN password 1313.
- Press UP or DOWN keys to scroll to **I/O Config**; press ENTER key.
- Press UP or DOWN keys to scroll to **Outdoor Hum Sensor (C7)**; press ENTER key.
- Reference the **Value** to see the input of the sensor (see Figure 53).
- To apply an offset, press ENTER key to scroll to **Offset**.
- Press UP or DOWN keys to change to the desired value.
- Press ENTER key to save the value.

FIGURE 53
Outdoor Humidity Sensor



Outdoor Temperature Sensor Failure Alarm

When the sensor reads a value that is outside of the acceptable -41 to 303.0° range, an alarm will be generated indicating the sensor has failed. This alarm condition will disable the economizer.

This alarm is fixed and cannot be adjusted.

Alarm index numbers: 11, 30, 45, 60

Outdoor Humidity Sensor Failure Alarm

When the sensor reads a value that is outside of the acceptable 0 to 100% RH range, an alarm will be generated indicating the sensor has failed. This alarm condition will disable the economizer when the mode is set to temperature and humidity or enthalpy.

This alarm is fixed and cannot be adjusted.

Alarm index numbers: 13, 32, 47, 62

Supply Temperature Sensor

The unit is equipped with a supply air temperature sensor to monitor the leaving air temperature of the unit. The temperature is measured with a 10k ohm NTC thermistor.

The supply air temperature can be verified by:

- Press MENU key to go to the Main Menu screen.
- Press UP or DOWN keys and ENTER key to enter TECHNICIAN password 1313.
- Press UP or DOWN keys to scroll to **I/O Config**; press ENTER key.
- Press UP or DOWN keys to scroll to **Supply Air Sensor (C6)**; press ENTER key.
- Reference the **Value** to see the input of the sensor (see Figure 54).
- To apply an offset, press ENTER key to scroll to **Offset**.
- Press UP or DOWN keys to change to the desired value.
- Press ENTER key to save the value.

FIGURE 54
Supply Air Sensor



Supply Temperature Sensor Failure Alarm

When the sensor reads a value that is outside of the acceptable -41.0 to 303.0° range, an alarm will be generated indicating the sensor has failed.

This alarm is fixed and cannot be adjusted.

Alarm index numbers: 145, 146, 147, 148

High Supply Air Temperature Alarm

When the supply air temperature measurement is above the outdoor air temperature setpoint (70°F) for the economizer to be enabled for 120 seconds, an alarm will be generated and the economizer will be disabled until the cooling call has been removed. This alarm will automatically reset once the economizer is no longer disabled.

Alarm index numbers: 14, 33, 48, 63

To change the high supply air temperature alarm:

1. Press MENU key to go to the Main Menu screen.
2. Press UP or DOWN keys and ENTER key to enter USER password 2000.
3. Press UP or DOWN keys to scroll to **System Config**; press ENTER key.
4. Press UP or DOWN keys to scroll to **Alarm Setup (A5)**; press ENTER key.
5. Press ENTER key to scroll to **Hi and Diff** value (see Figure 55).
6. Press UP or DOWN keys to change the differential to the desired value.
7. Press ENTER key to save and scroll to the next parameter.

FIGURE 55
Adjusting Supply Air Temperature Differential

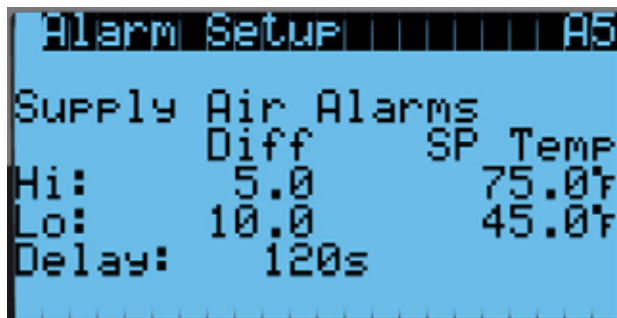

Low Supply Air Temperature Alarm

When the supply air temperature is below 45°F for 120 seconds, an alarm will be generated and the economizer will be disabled until the cooling call has been removed. This alarm will automatically reset when the economizer is no longer disabled.

Alarm index numbers: 15, 34, 49, 64

To change the low supply air temperature alarm:

1. Press MENU key to go to the Main Menu screen.
2. Press UP or DOWN keys and ENTER key to enter USER password 2000.
3. Press UP or DOWN keys to scroll to **System Config**; press ENTER key.
4. Press UP or DOWN keys to scroll to **Alarm Setup (A5)**; press ENTER key.
5. Press ENTER key to scroll to **Lo and Diff** value (see Figure 54).
6. Press UP or DOWN keys to change the differential to the desired value.
7. Press ENTER key to save value and scroll to **Delay**.
8. Press UP or DOWN keys to adjust the delay value.

NOTE: This delay is also applied to the high supply air temperature alarm.

9. Press ENTER key to save.

Economizer Operation

The economizer has four types of operation. The first mode is "None" where the economizer is never utilized, except for emergency purposes. The second mode is "Dry Bulb" where the outdoor temperature is the only consideration for economizer use on a freecooling call. The third mode is "TempHum" where the outdoor temperature and humidity are considered for economizer use on a freecooling call. The fourth mode is "Enthalpy" where the outdoor temperature, humidity and calculated dew point are considered for economizer operation on a freecooling call.

To change the economizer type:

1. Press MENU key to go to the Main Menu screen.
2. Press UP or DOWN keys and ENTER key to enter USER password 2000.
3. Press UP or DOWN keys to scroll to **System Config**; press ENTER key.
4. Press UP or DOWN keys to scroll to **Economizer Setup (A2)**; press ENTER key.
5. Press ENTER key to scroll to **Type** (see Figure 56 on page 34).
6. Press UP or DOWN keys to change the **Type** desired value to **None**, **Dry Bulb**, **TempHum** or **Enthalpy**.
7. Press ENTER key to save the value and scroll to the next parameter.

FIGURE 56
Economizer Setup

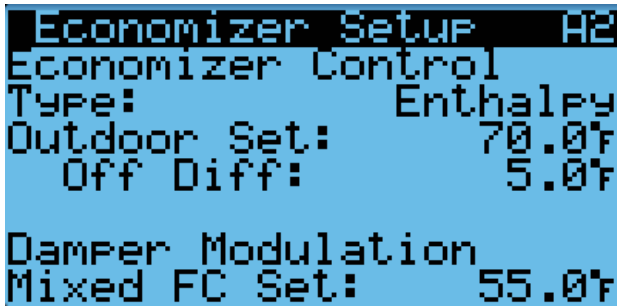

NOTE: The following parameters are for the temperature consideration for economizer use. Applies to **Dry Bulb**, **TempHum** and **Enthalpy** type.

8. The cursor should now be on the **Outdoor Set** parameter.
9. Press UP or DOWN keys to change the parameter to the desired value.
10. Press ENTER key to save the value and scroll to the next parameter.
11. The cursor should now be on **Off Diff** parameter.
12. Press UP or DOWN keys to change the parameter to the desired value.
13. Press ENTER key to save the value and move to the next parameter.
14. The cursor is now on the **Mixed FC Set** parameter.
15. Press UP or DOWN keys to change the parameter to the desired value.
16. Press ENTER key to save the value.
17. Press the DOWN key to navigate to the **A3** screen.

NOTE: This screen will not display if economizer mode is set to **Dry Bulb** or **None**. Also, the contents of the screen will change when type is set to **Enthalpy** (see Figure 57) as compared to when type is set to **TempHum** (see Figure 58). The following menu shows the **Enthalpy** content which also contains parameters that would be shown on **TempHum**.

18. Press ENTER key to scroll to **OA Humid Set** (see Figure 56).
19. Press UP or DOWN keys to change the humidity setpoint to desired value.
20. If set to **TempHum**, continue on to Step 22. If set to **Enthalpy**, press ENTER key to save the value and scroll to **OA Dew Pt Set**.
21. Press UP or DOWN keys to adjust the outdoor dew point setpoint for economizer operation to the desired value.
22. Press ENTER key to save the value and scroll to **On Diff**.

23. Press UP or DOWN keys to adjust the outdoor humidity differential for which the economizer is re-enabled.
24. Press ENTER key to save the value and scroll to parameter **Delay**.
25. Press UP or DOWN keys to adjust the time the actual measurements can be outside of the disabling parameters before the economizer operation is disabled.
26. Press ENTER key to save the value.
27. Press ESCAPE key several times to return to Main Menu screen.

See Table 8 for default settings for economizer operation.

FIGURE 57
Economizer Setup – Enthalpy Control

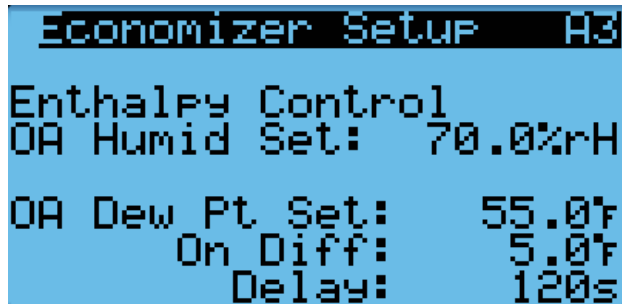
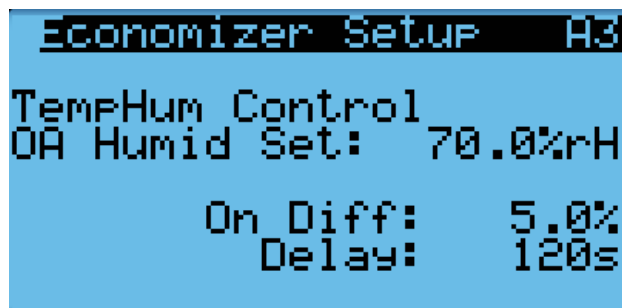

FIGURE 58
Economizer Setup – TempHum Control



When the economizer is activated during a freecooling call only, using any of the previously mentioned modes, a 0-10v analog signal will be sent to the economizer actuator. The actuator will then open and close the damper blades to maintain a supply air temperature of 55°F. If the economizer is active during optimized cooling mode, the actuator will maintain a mixed air temperature of 55°F. When the supply/mixed air temperature increases, the damper will open and when the mixed air temperature decreases, the damper will close.

The economizer may be disabled by the LC if the system determines it needs to enter dehumidification mode. More information about the dehumidification

**TABLE 8
Economizer Default Settings**

Mode			Consideration	Economizer Available for Cooling	Economizer Not Available for Cooling
Temp Only	Temp & Humidity	Enthalpy*	Temperature	When the outdoor air temperature is below 70°F	When the outdoor air temperature is above 75°F
			Humidity	LC Online: When the outdoor humidity is below 80%	LC Online: When the outdoor humidity is above 80%
				LC Offline: When the outdoor humidity is below 60%	LC Offline: When the outdoor humidity is above 60%
		Dew Point	When the outdoor dew point is below 55°F	When the outdoor dew point is above 60°F	

* In Enthalpy mode, outdoor temperature, humidity and calculated dew point are all considered for economizer operation.

sequence can be found on page 15 and in the latest revision of LC6000 Service Instructions 2100-669. In addition to dehum mode, the economizer may be disabled for 5 minutes (adjustable) if the dust sensor indicates the outdoor air may cause particulate buildup in the air filters. After the time has expired and on a call for cooling, the economizer will open again to sample the air. The wall-mount unit will either return to normal operation or remain locked out for another 5 minutes.

Emergency Cooling Mode

If the shelter temperature is above the high temperature alarm setpoint on the LC, the unit will be commanded into emergency cooling mode. In this mode, the unit will operate the economizer regardless of the economizer setup, as long as the outdoor temperature is below the indoor temperature. The cooling demand will be automatically set to 100% in this mode, meaning mechanical cooling should be operating at full capacity while this mode is active. This will stay active until the LC returns the unit to normal operation. This mode is only available when connected to the LC.

Emergency Ventilation Mode

If a hydrogen detector is connected to the LC/FUSION-TEC system and there is a hydrogen alarm event, the system will go into emergency ventilation mode. In emergency ventilation mode, the economizers on the wall units will be commanded to 100%. After 2 minutes, the blowers will turn on in order to exhaust any hydrogen gas buildup within the shelter. Once the hydrogen alarm clears, the system will resume normal operation. This mode is only available when connected to the LC.

Model/Serial Number Configuration

HR Series wall-mount units configure some settings based on the model number that is input into the unit. The model and serial number are entered at the factory, and should be retained during a software update. However, after a software update, it is best practice to verify that the model and serial number is still present

and accurate. If the model and/or serial number is missing or incorrect they will need to be re-entered.

To update model/serial numbers:

1. Press MENU key to go to the Main Menu screen.
 2. Press UP or DOWN keys and ENTER key to enter ENGINEER password 9254.
 3. Press UP or DOWN keys to scroll to **Adv Sys Config**; press ENTER key.
 4. Press UP or DOWN keys to scroll to **Factory Settings (B1)**.
 5. Press ENTER key to advance the cursor to the digit that needs changed in the model/serial number.
 6. Press UP or DOWN keys to change value of the digit.
- NOTE:** The characters are in ASCII format and some digits may not have a character assigned to them. This will required pressing the UP or DOWN key until these characters are passed.
7. Continue Steps 5 and 6 until the model/serial number(s) are correct and reflect the number on the product label.

For more information on the options and settings available for specific model numbers, please see the model number breakdown in Figure 59 on page 37.

Electric Heat Option

Electric Heat Components

Electric Heating Element

The unit is optionally equipped with a 1.5kw or 5kw heat strip. The heat strip is located next to the blower assembly and uses resistive heat.

Thermal Overload

The heater assembly has a thermal overload wired in series with the heating element. This device has a cycling limit which opens at 130°F and resets at 80°F. The limit is also equipped with a redundant thermal fuse that will open at 150°F.

Electric Heat Operation

The heat strip will be activated on a call for heat. This call can be generated by the LC or the wall-mount unit operating in stand alone mode.

Bard Guard Anti-Theft System Option

The unit has the option to be shipped from the factory with a low pressure switch, panel sensors and a speaker. These devices are used with the Bard Guard BG1000 anti-theft controller to provide an anti-theft measure. These sensors and switch form a loop that when connected to the BG1000 controller will cause the system to go into alarm if any of the front panels or coil assemblies are removed without being disarmed. The speaker provides an audible alert that the system is being tampered with. The Bard Guard anti-theft control sensor connection is wired to terminals 7 and 8 on the wall-mount unit. The speaker connection is wired to terminals 5 and 6 on the wall-mount unit. See the latest revision of BG1000 Installation Instructions 2100-672 for directions on connecting the wall-mount units to the BG1000 controller.

Alarm index number: 79

Smoke Detector Unit Disable Option

The unit is equipped with an input that can be used with a smoke detector or unit disable switch with a dry contact. When this input indicates a smoke event, the system will be shut down. The alarm will automatically clear when the alarm condition is no longer present.

Alarm index numbers: 22, 41, 56, 71

Inverter Option

The inverter is only used in applications where a generator is not present and the wall-mount units must run during a power loss event. The inverter will always keep power available to the wall-mount units during a power outage. In the event of a power outage, a power loss relay in the wall-mount unit will be energized and will only allow the blower and economizer to run while powering the controller. The inverter converts either 24 VDC or 48 VDC, depending on the model, to 230 VAC. A relay output from the inverter will also communicate an alarm to the supervisory controller in the event of an inverter failure. This variable can be communicated through the Ethernet port for integration into a building management system. The units will continue to run in economizer-only operation until power has been restored or the battery power has been depleted.

When the wall-mount unit is operating under inverter power, shelter economizer cooling will only occur if outside temperatures fall below indoor temperatures and blower speeds are slightly reduced to conserve battery power.

FIGURE 59
WR Series Wall-Mount Unit Model Nomenclature

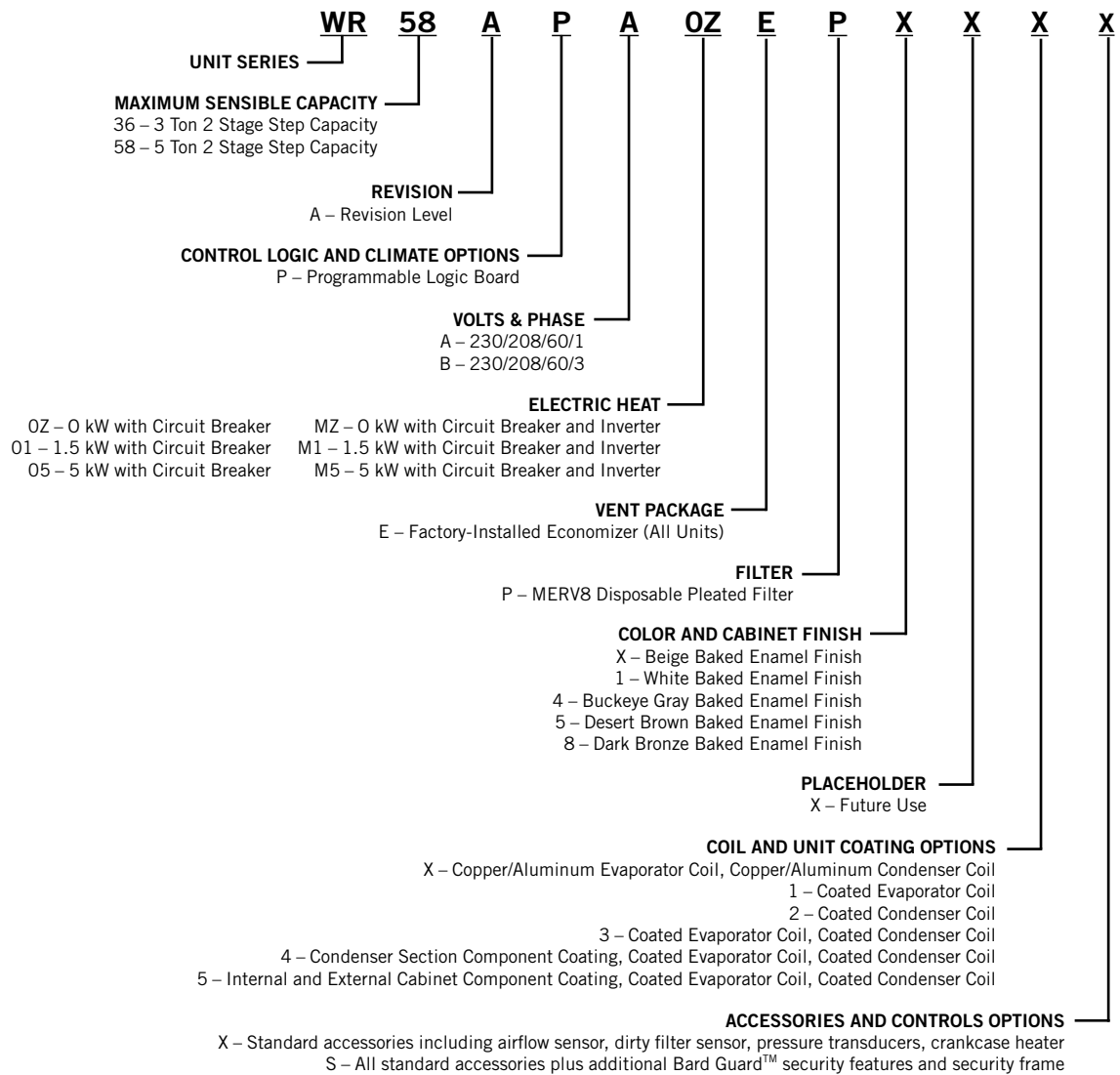

REFRIGERANT INFORMATION

NOTICE

These units require R-410A refrigerant and polyol ester oil.

General

1. Use separate service equipment to avoid cross contamination of oil and refrigerants.
2. Use recovery equipment rated for R-410A refrigerant.
3. Use manifold gauges rated for R-410A (800 PSI/250 PSI low).
4. R-410A is a binary blend of HFC-32 and HFC-125.
5. R-410A is nearly azeotropic—similar to R-22 and R-12. Although nearly azeotropic, charge with liquid refrigerant.
6. R-410A operates at 40-70% higher pressure than R-22, and systems designed for R-22 cannot withstand this higher pressure.
7. R-410A has an ozone depletion potential of zero, but must be reclaimed due to its global warming potential.
8. R-410A compressors use polyol ester oil.
9. Polyol ester oil is hygroscopic; it will rapidly absorb moisture and strongly hold this moisture in the oil.
10. A liquid line dryer must be used—even a deep vacuum will not separate moisture from the oil.
11. Limit atmospheric exposure to 15 minutes.
12. If compressor removal is necessary, always plug compressor immediately after removal. Purge with small amount of nitrogen when inserting plugs.

Topping Off System Charge

If a leak has occurred in the system, Bard Manufacturing recommends reclaiming, evacuating (see criteria above) and charging to the nameplate charge. If done correctly, topping off the system charge can be done without problems.

With R-410A, there are no significant changes in the refrigerant composition during multiple leaks and recharges. R-410A refrigerant is close to being an azeotropic blend (it behaves like a pure compound or single component refrigerant). The remaining refrigerant charge in the system may be used after leaks have occurred. “Top-off” the charge by utilizing the pressure charts on the inner control panel cover as a guideline.

REMEMBER: When adding R-410A refrigerant, it must come out of the charging cylinder/tank as a liquid to avoid any fractionation and to insure optimal system performance. Refer to instructions for the cylinder that is being utilized for proper method of liquid extraction.

Safety Practices

1. Never mix R-410A with other refrigerants.
2. Use gloves and safety glasses. Polyol ester oils can be irritating to the skin, and liquid refrigerant will freeze the skin.
3. Never use air and R-410A to leak check; the mixture may become flammable.
4. Do not inhale R-410A—the vapor attacks the nervous system, creating dizziness, loss of coordination and slurred speech. Cardiac irregularities, unconsciousness and ultimately death can result from breathing this concentration.
5. Do not burn R-410A. This decomposition produces hazardous vapors. Evacuate the area if exposed.
6. Use only cylinders rated DOT4BA/4BW 400.
7. Never fill cylinders over 80% of total capacity.
8. Store cylinders in a cool area, out of direct sunlight.
9. Never heat cylinders above 125°F.
10. Never trap liquid R-410A in manifold sets, gauge lines or cylinders. R-410A expands significantly at warmer temperatures. Once a cylinder or line is full of liquid, any further rise in temperature will cause it to burst.

Important Installer Note

For improved start-up performance, wash the indoor coil with a dishwashing detergent.

R410-A Refrigerant Charge

This wall-mount unit was charged at the factory with the quantity of refrigerant listed on the serial plate. AHRI capacity and efficiency ratings were determined by testing with this refrigerant charge quantity.

Table 9 shows nominal pressures for the units. Since many installation specific situations can affect the pressure readings, this information should only be used by certified technicians as a guide for evaluating proper system performance. They shall not be used to adjust charge. If charge is in doubt, reclaim, evacuate and recharge the wall-mount unit to the serial plate charge.

Pressure Service Ports

High and low pressure service ports are installed on all wall-mount units so that the system operating pressures can be observed. Pressures are shown in Table 9.

This unit employs high-flow Coremax valves instead of the typical Schrader type valves.

WARNING! Do NOT use a Schrader valve core removal tool with these valves. Use of such a tool could result in eye injuries or refrigerant burns!

To change a Coremax valve without first removing the refrigerant, a special tool is required which can be obtained at www.fastestinc.com/en/SCCA07H. See the replacement parts manual for replacement core part numbers.

TABLE 9
Cooling Pressures

Full Load Cooling			Air Temperature Entering Outdoor Coil °F										
Model	Return Air Temp (DB/WB)	Pressure	75	80	85	90	95	100	105	110	115	120	125
WR36	75/62	Low Side	130	131	132	134	135	136	137	138	139	140	142
		High Side	290	312	334	359	384	411	439	468	498	530	564
	80/67	Low Side	139	140	141	143	144	145	147	148	149	150	152
		High Side	297	320	343	368	394	422	450	480	511	544	578
	85/72	Low Side	144	145	146	148	149	150	152	153	154	155	157
		High Side	307	331	355	381	408	437	466	497	529	563	598
WR58	75/62	Low Side	129	130	131	132	133	134	136	137	137	139	140
		High Side	318	340	365	389	414	440	467	495	527	553	584
	80/67	Low Side	138	139	140	141	142	143	145	146	147	149	150
		High Side	326	349	374	399	425	451	479	508	537	567	599
	85/72	Low Side	143	144	145	146	147	148	150	151	152	154	155
		High Side	337	361	387	413	440	467	496	526	556	587	620

Part Load Cooling			Air Temperature Entering Outdoor Coil °F										
Model	Return Air Temp (DB/WB)	Pressure	75	80	85	90	95	100	105	110	115	120	125
WR36	75/62	Low Side	119	125	131	136	140	143	146	148	149	150	149
		High Side	268	288	308	331	354	378	405	432	460	490	522
	80/67	Low Side	127	134	140	145	150	153	156	158	159	160	159
		High Side	275	295	316	339	363	388	415	443	472	503	535
	85/72	Low Side	131	139	145	150	155	158	161	164	165	166	165
		High Side	285	305	327	351	376	402	430	459	489	521	554
WR58	75/62	Low Side	135	136	136	137	137	138	138	140	141	142	143
		High Side	283	304	327	350	375	402	428	456	486	416	547
	80/67	Low Side	144	145	145	146	147	148	148	150	151	152	153
		High Side	290	312	335	359	385	412	439	468	498	529	561
	85/72	Low Side	149	150	150	151	152	153	154	155	156	157	158
		High Side	300	323	347	372	398	426	454	484	515	548	581

Low side pressure ± 4 PSIG
High side pressure ± 10 PSIG

Tables are based upon rated CFM (airflow) across the evaporator coil. If there is any doubt as to correct operating charge being in the system, the charge should be removed and system evacuated and recharged to serial plate charge weight.

NOTE: Pressure table based on high speed condenser fan operation. If condensing pressures appear elevated check condenser fan wiring. See "Condenser Fan Operation" on page 23.

MAINTENANCE

Standard Maintenance Procedures

WARNING

Electrical shock hazard.

Disconnect all power supplies before servicing.

Failure to do so could result in electric shock or death.

CAUTION

Cut hazard.

Wear gloves to avoid contact with sharp edges.

Failure to do so could result in personal injury.

1. Disable system from LC6000 controller (see latest revision of LC6000 Service Instructions 2100-669).
2. Turn off AC breakers at wall-mount units.
3. Check inlet sides of condenser and evaporator coils for obstructions/debris—clean if necessary using a quality manufactured coil cleaning product specific for the evaporator or condenser coil.
 - Condenser coil: Remove the upper side panels from the condenser section. This will give clear access to the inlet side of the coil for cleaning. Follow the coil cleaner manufacturer's directions for necessary safety gear and precautions, as well as for application and use. More than one application may be necessary. Rinse thoroughly.
 - Evaporator coil: Open filter access panels and remove filters. Apply specific evaporator cleaner directly to the inlet side of coil, being very careful not to overspray into insulation or surrounding panels and wiring. Residual cleaner and dissolved debris should drip into the drain pan and leave the unit through the condensate hose. More than one application may be necessary. Rinse thoroughly.
4. Manually spin fan and blower motors to ensure they turn freely. All motors are permanently lubricated, so no oil is necessary.
5. Inspect free cooling damper actuator and linkage.
6. Install new air filter; check for additional filter grilles internal to the structure.
7. Inspect the control panel of the system.
 - Look for insect or rodent activity and remove any nesting materials.
 - Manually push contactor closed, observe for movement—contactor points should have minimal discoloration, no spalling or other signs of arcing. Replace if doubtful.
 - Check field and factory wiring for tightness and look for signs of overheating (discoloration of terminals or wire insulation).
8. Ensure that supply and return registers are not obstructed, and more importantly, are not recycling the air to one another. Adjust supply louvers if necessary to direct discharge air away from any direct route to the return grille.
9. Re-assemble wall-mount unit, turn breakers back on.
10. Enable system to LC6000 controller (see latest revision of LC6000 Service Instructions 2100-669).
11. Repeat steps for additional wall-mount units.

Bard Guard Anti-Theft System Option

While the system is powered, push DISARM/RESET button to disarm the system. Once the button is pushed, the blue LED will illuminate. As long as the blue LED is illuminated, the Bard Guard system is disarmed and will remain disarmed depending on the preset time for up to 250 minutes (default approximately 15 minutes). After the preset time expires, the system will rearm automatically.

For situations that require an individual unit to be disconnected from the Bard Guard security system for an extended period of service time (longer than the maximum 250 minutes disarm time), place a jumper across the appropriate terminals on the BG1000 terminal block to temporarily remove the unit from the security system. **Be sure to remove the jumper from the terminals after service has been completed.**

See the latest revision of BG1000 Installation Instructions 2100-672 for information on operating the BG1000 controller.