INSTALLATION INSTRUCTIONS

Partial Flow Commercial Room Ventilator 24 Volt On/Off with Spring Return and Exhaust

Models:
CRV-F2 CRV-F3

For Use with Bard Wall Mount
Air Conditioner and Heat Pump Models:

CRV-F2: W18A/LB, W24A/LB, W18HB, W24HB
CRV-F3: W30A/LB, W36A/LB, W30HB, W36HB



Climate Control Solutions

Bard Manufacturing Company, Inc.
Bryan, Ohio 43506
www.bardhvac.com

Manual: 2100-691A
Supersedes: 2100-691
Date: 11-1-19

CONTENTS

General Information	3
Commercial Room Ventilator Model Nomenclature...	3
Unpacking	3
Field-Supplied Tools Needed	3
General	3
Description	3
Application	3
Installation of Field-Installed CRV-F*	4
Basic Installation.....	4
Preparing Unit for CRV-F Installation	4
Commercial Room Ventilator (CRV) No Hood Installation	7
Blade Adjustment for Desired Ventilation Air	13
Balanced Climate™ Mode.....	13
Figures	
Figure 1 Wall Mount Unit Access Panels	4
Figure 2 Condenser Exhaust Plate with Screen.....	5
Figure 3 Filter Bracket and Filter Bracket Fill Plate Installation	6
Figure 4 Extension Cable Installation	7
Figure 5 Damper Assembly Installation	8
Figure 6 Vent Door Assembly.....	8
Figure 7 Programmable Thermostat Connections for CRV-F* with Air Conditioners.....	9
Figure 8 Programmable Thermostat Connections for CRV-F* with Heat Pumps	10
Figure 9 Non-Programmable Thermostat Connections for CRV-F* with Air Conditioners	11
Figure 10 Non-Programmable Thermostat Connections for CRV-F* with Heat Pumps	12
Figure 11 Blade Adjustment for Ventilation Air	13
Figure 12 Call for Ventilation With or Without Compressor Operation	16
Figure 13 Call for Compressor or Fan Only with Ventilation Off	17
Figure 14 Wiring Diagram.....	18
Graphs	
Graph 1 W18 Ventilation Delivery.....	14
Graph 2 W24 Ventilation Delivery.....	14
Graph 3 W30 Ventilation Delivery.....	15
Graph 4 W36 Ventilation Delivery.....	15

WARNING

Electrical shock hazard.
Disconnect remote electrical power supply or supplies before servicing.
Failure to do so could result in electric shock or death.

WARNING

Exposed moving parts.
Disconnect all electrical power before servicing.
Failure to do so can result in severe injury or amputation.

CAUTION

Sharp metallic edges.
Take care and wear appropriate protective devices to avoid accidental contact with sharp edges.
Failure to do so can result in personal injury.

CRV Features

- One piece construction – easy to install.
- Exhaust air damper – built in with positive closed position. Provides exhaust air capability to prevent pressurization of tight buildings.
- Actuator motor – 24 volt, power open, spring return with built in torque limiting switch.

Commercial Room Ventilator Model Nomenclature

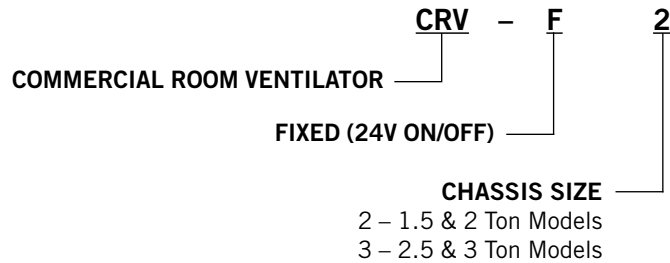

Unpacking

Upon receipt of the equipment be sure to compare the model number found on the shipping label with the accessory identification information on the ordering and shipping document to verify that the correct accessory has been shipped.

Inspect the carton housing of each ventilator as it is received, and before signing the freight bill, verify that all items have been received and that there is no visible damage. Note any shortages or damage on all copies of the freight bill. The receiving party must contact the last carrier immediately, preferably in writing, requesting inspection by the carrier's agent. Concealed damage not discovered until after loading must be reported to the carrier within 15 days of its receipt.

Field-Supplied Tools Needed

- Appropriate personal protection equipment, including gloves and safety glasses
- 5/16" nut driver
- Phillips head screwdriver
- Small flat head screwdriver for securing wire in terminal blocks
- Electrical tools
- Multimeter

General

The ventilator should only be installed by a trained heating and air conditioning technician. These instructions serve as a guide to the technician installing the ventilator package. They are not intended as a step-by-step procedure with which the mechanically inclined owner can install the package.

The ventilator housing is shipped in one carton which contains the electrical harness, miscellaneous hardware and installation instructions.

Description

Commercial room ventilators CRV-F2 and CRV-F3 are designed to be used with the specific models with "letter" revision codes as designated on the front page of this installation instructions manual.

The CRV-F ventilator is an electromechanical vent system designed to provide fresh air to meet indoor air quality standards.

Commercial room ventilators CRV-F2 and CRV-F3 are internally mounted dampers with exhaust designed to provide up to 50% fresh air. The damper blade is powered by a 24 VAC motor with spring return on power loss. The damper is powered open anytime A is energized. Blade stop screws are located under the fresh air blade and will provide 10 different airflow settings.

When installed in the models listed on the front page, the CRV-F provides built-in exhaust provisions. When the damper blade opens to bring fresh air in, the damper also opens an exhaust relief. The exhaust air will flow into the condenser section of the unit. The condenser fan will help draw exhaust air out when it is operating with compressor in cooling or heat pump mode.

Application

The amount of outside fresh air brought into the structure is dependent on the supply and return duct static pressure present in the duct system. Refer to Graphs 1-4 on pages 14 – 15 for ventilation air that will be supplied at different blade settings and duct static pressures. For duct-free applications with return air filter grilles and supply grilles, use 0.00 supply air static pressure.

INSTALLATION OF FIELD-INSTALLED CRV-F*

Basic Installation

Preparing Unit for CRV-F Installation

1. Disconnect power to unit.
2. Unpack the CRV-F assembly, which includes the integral controls and electrical harness, body panels, miscellaneous hardware and installation instructions.
3. From existing wall mount unit, remove and save (or discard) as directed (see Figure 1):
 - Blower access panel (save)
 - Ventilation access panel (discard)
 - Filter access panel (save)
 - Filter (save)
 - Outer and inner control panel doors (save)
 - Filter tray (discard, if applicable)
 - Exhaust cover plate (discard)
4. Install new condenser exhaust plate with screen over opening into condenser section (see Figure 2).
5. Remove filter brackets. Two types of filter brackets have been used with these wall mount units. If the filter brackets are mounted flat, they can be used with the commercial room ventilator (CRV). If the brackets are set at a 30° angle, they must be removed, discarded and fill plates added (see Step 6). The circuit breaker offset plate must be loosened and moved slightly to gain access to several of the screws holding the filter brackets in place. Tighten the screws holding control panel after the filter brackets have been removed.

If filter brackets were removed in Step 5, proceed to Step 6. If the brackets were not removed, proceed to **Commercial Room Ventilator (CRV) No Hood Installation** on page 7.
6. Install filter bracket fill plate (if applicable) as shown in Figure 3 on page 6.
7. Install provided filter brackets on CRV-F assembly (see Figure 3).

FIGURE 1
Wall Mount Unit Access Panels

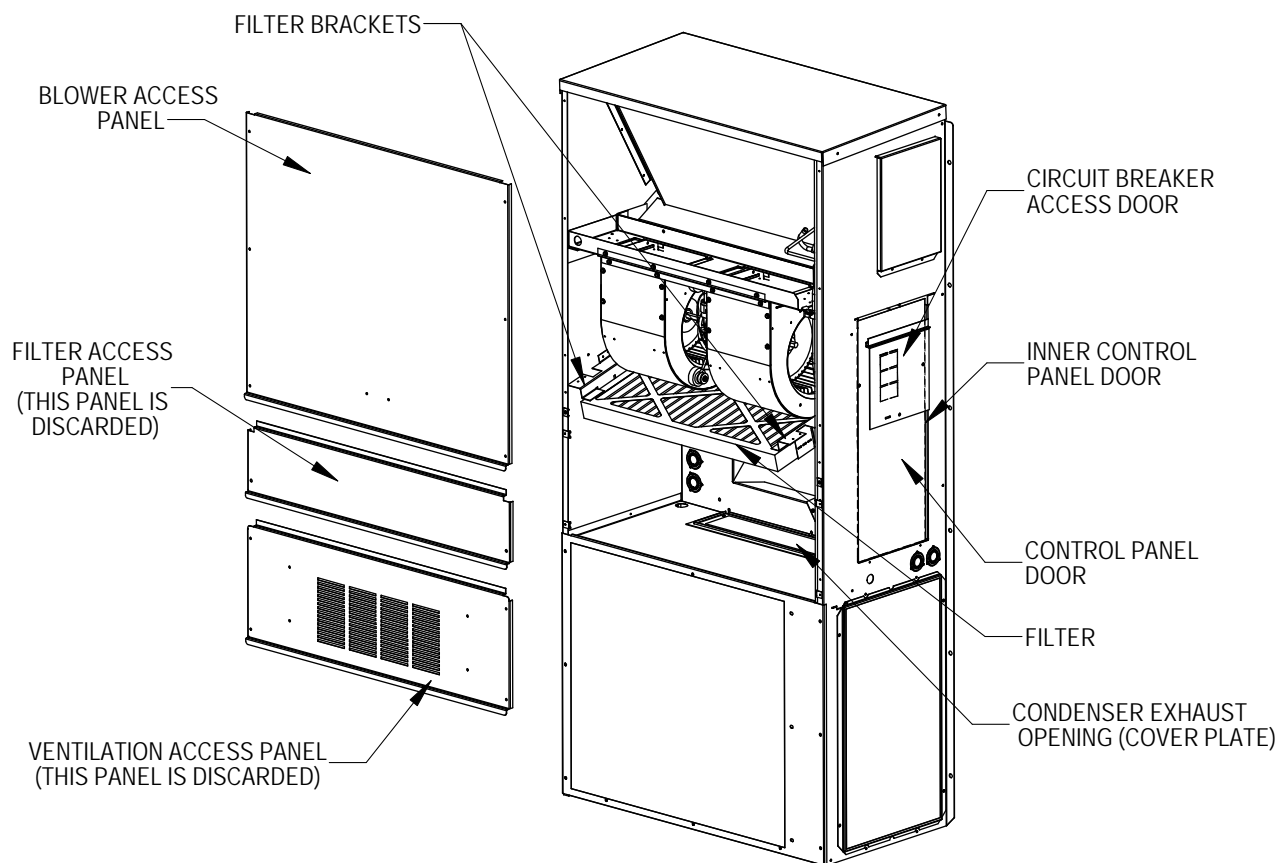

MIS-3619 A

FIGURE 2
Condenser Exhaust Plate with Screen

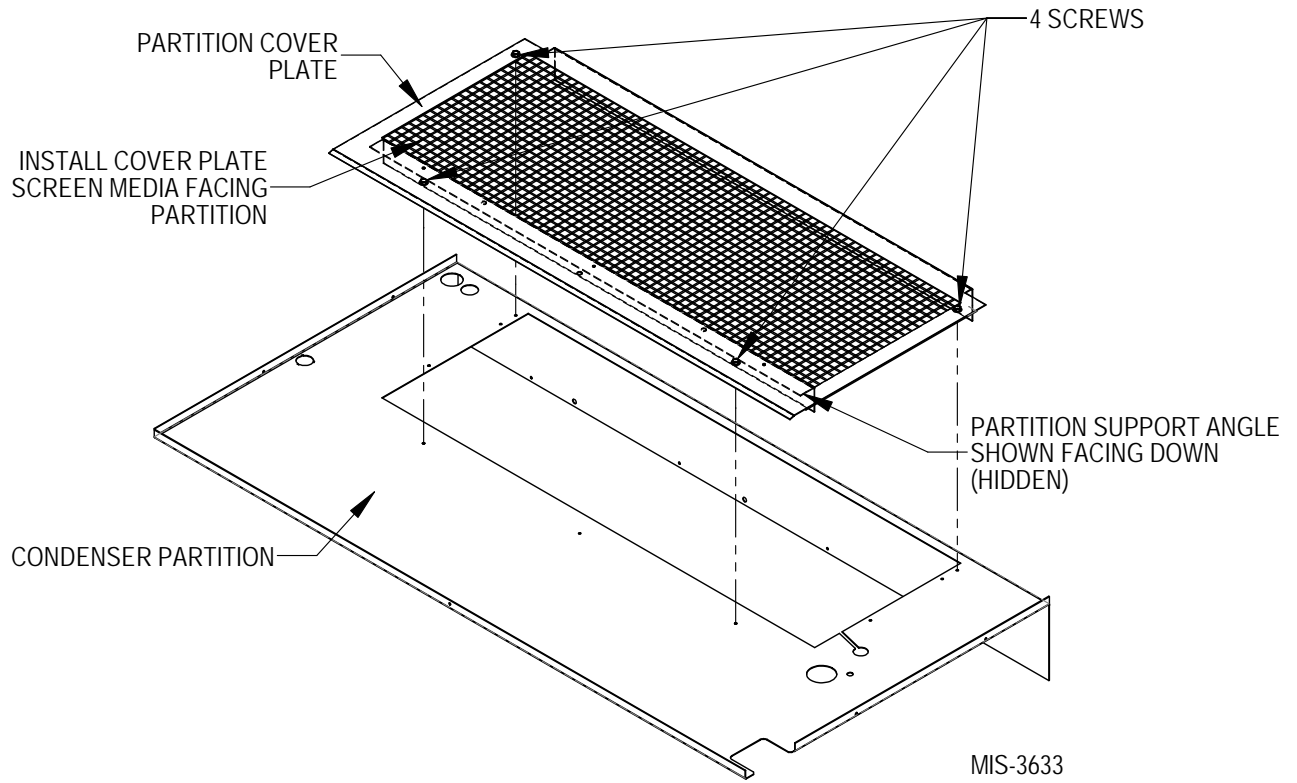
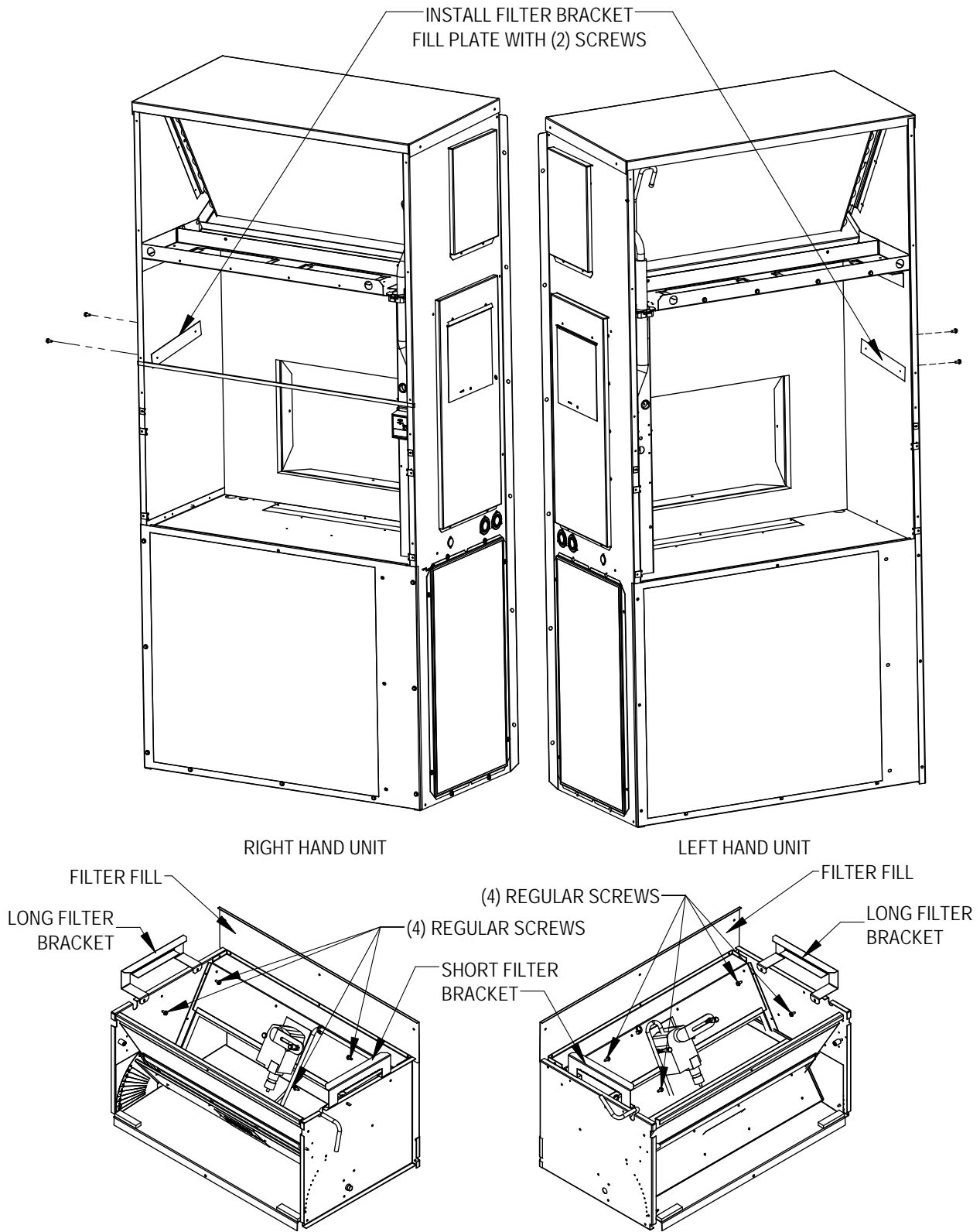

FIGURE 3
Filter Bracket and Filter Bracket Fill Plate Installation



MIS-3988

Commercial Room Ventilator (CRV) No Hood Installation

1. Insert CRV into opening in the wall mount unit between the filter rack and the condenser section, being careful not to tear the unit insulation. Fully seat CRV assembly to rear of the cavity. Slide the CRV toward the control panel so that it lines up with the return air opening in the rear of the wall mount unit (see Figure 5 on page 8).
2. Insert and lock in the 12-pin plug end of the wire assembly into the front side of the unit's control panel (see Figure 5).
3. Replace the air filter if it was removed (airflow direction is up).
4. Put mist eliminator filter into place (as shown in Figure 6 on page 8), then install the unit filter door.
5. Make all the required thermostat connections per the applicable connection diagram found on pages 9 or 10, and restore power to the unit.
6. Replace the lower vent option door with new door provided using the four (4) screws provided as shown in Figure 6.

FIGURE 4
Extension Cable Installation

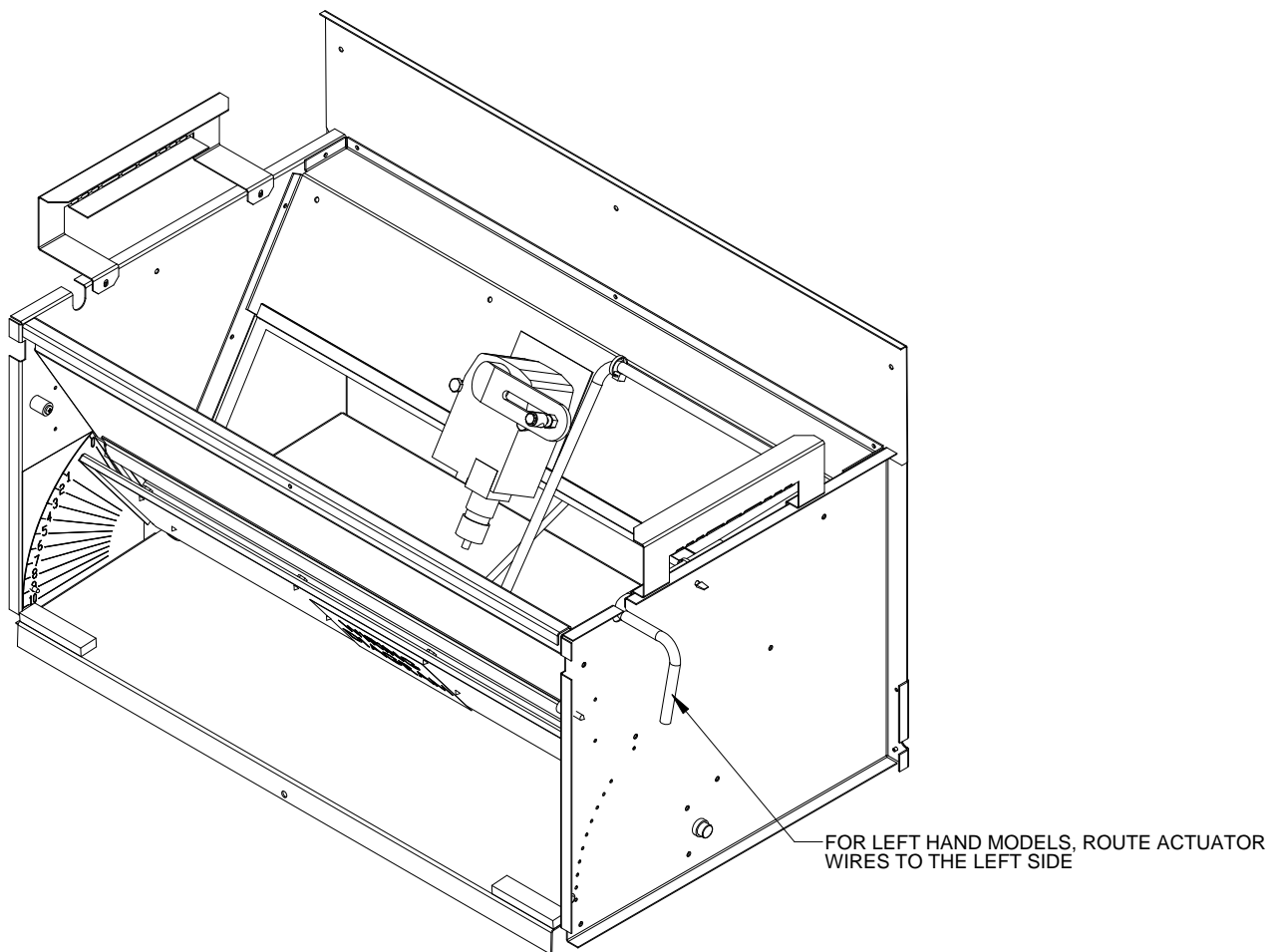

NOTE: Incorporated with the CRV-F is one piece of 20" split tubing. The tubing will cover the wire assembly routed to the actuator. The tubing and wires will be routed under the actuator assembly.

MIS-3989

FIGURE 5
Damper Assembly Installation

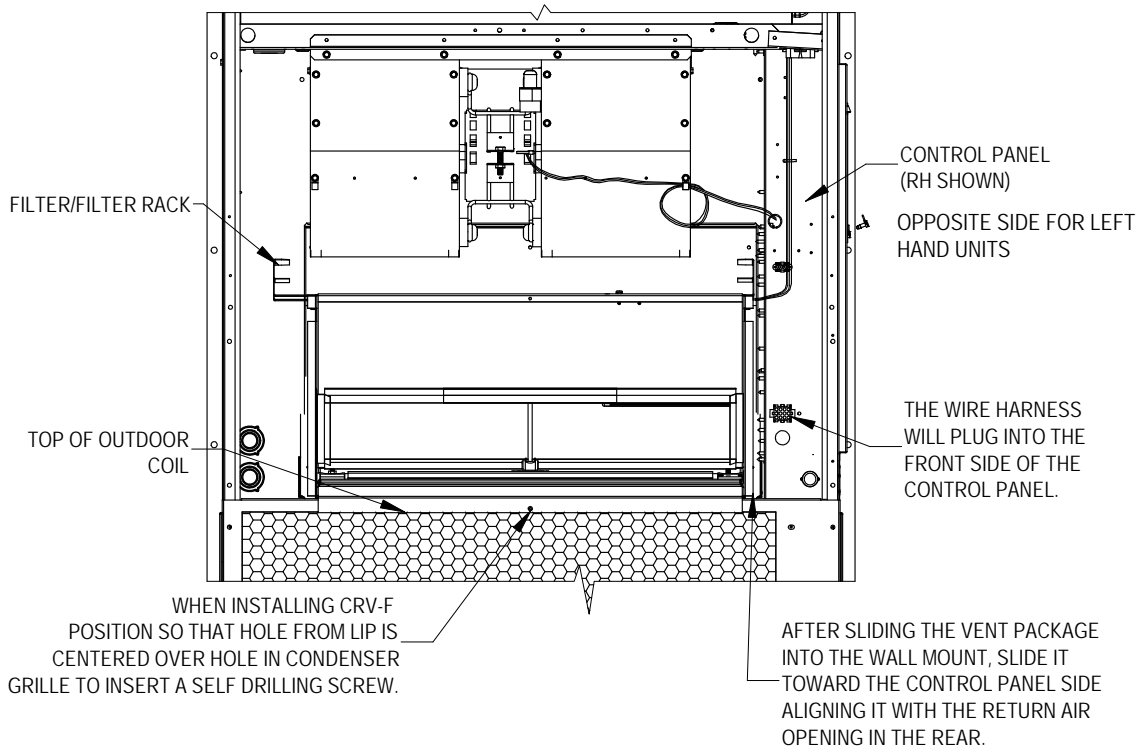

MIS-3999

FIGURE 6
Vent Door Assembly

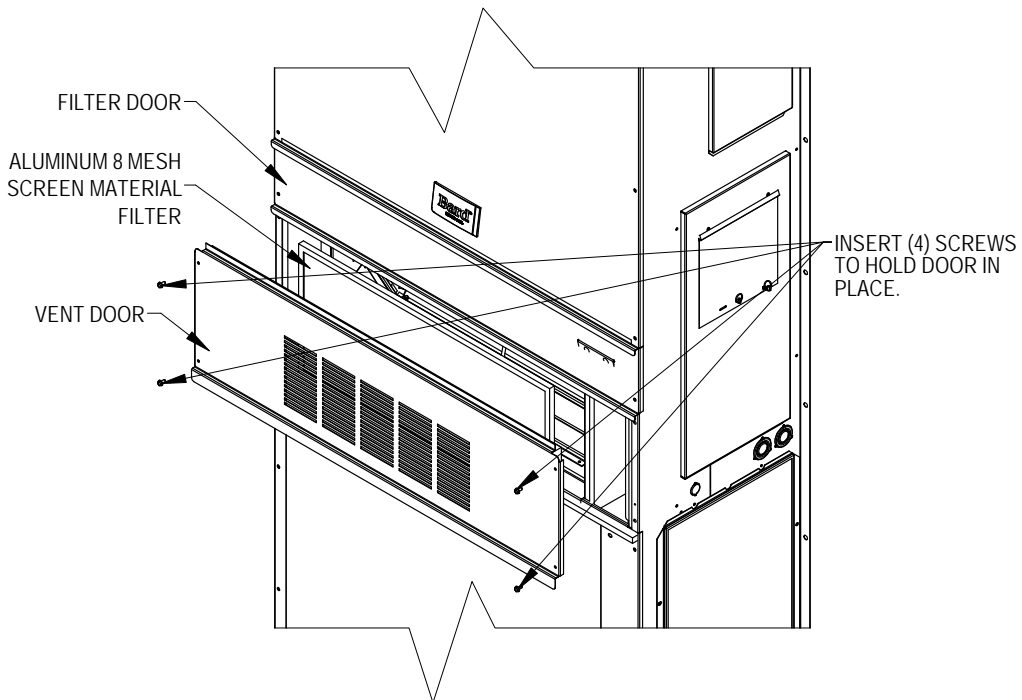

MIS-3865

FIGURE 7
Programmable Thermostat Connections for CRV-F* with Air Conditioners

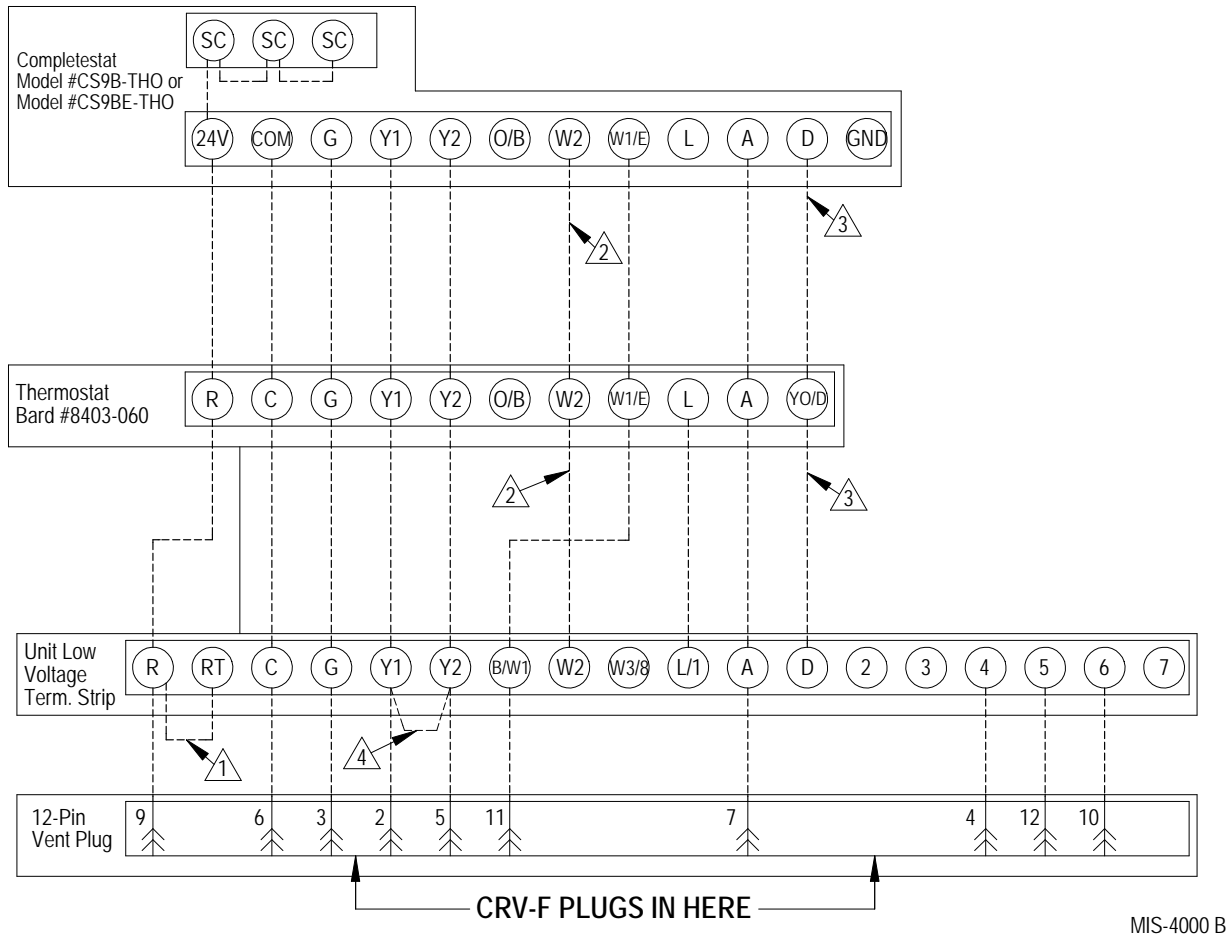

△1 Factory installed jumper. Remove jumper and connect to N.C fire alarm circuit if emergency shutdown required.
 △2 Not needed below 15KW.

△3 Additional wire required for dehumidification models.
 △4 Factory installed jumper. Remove to activate Balanced Climeate™ mode. A 2 stage thermostat is recommended for Balanced Climate mode.

FIGURE 8
Programmable Thermostat Connections for CRV-F* with Heat Pumps

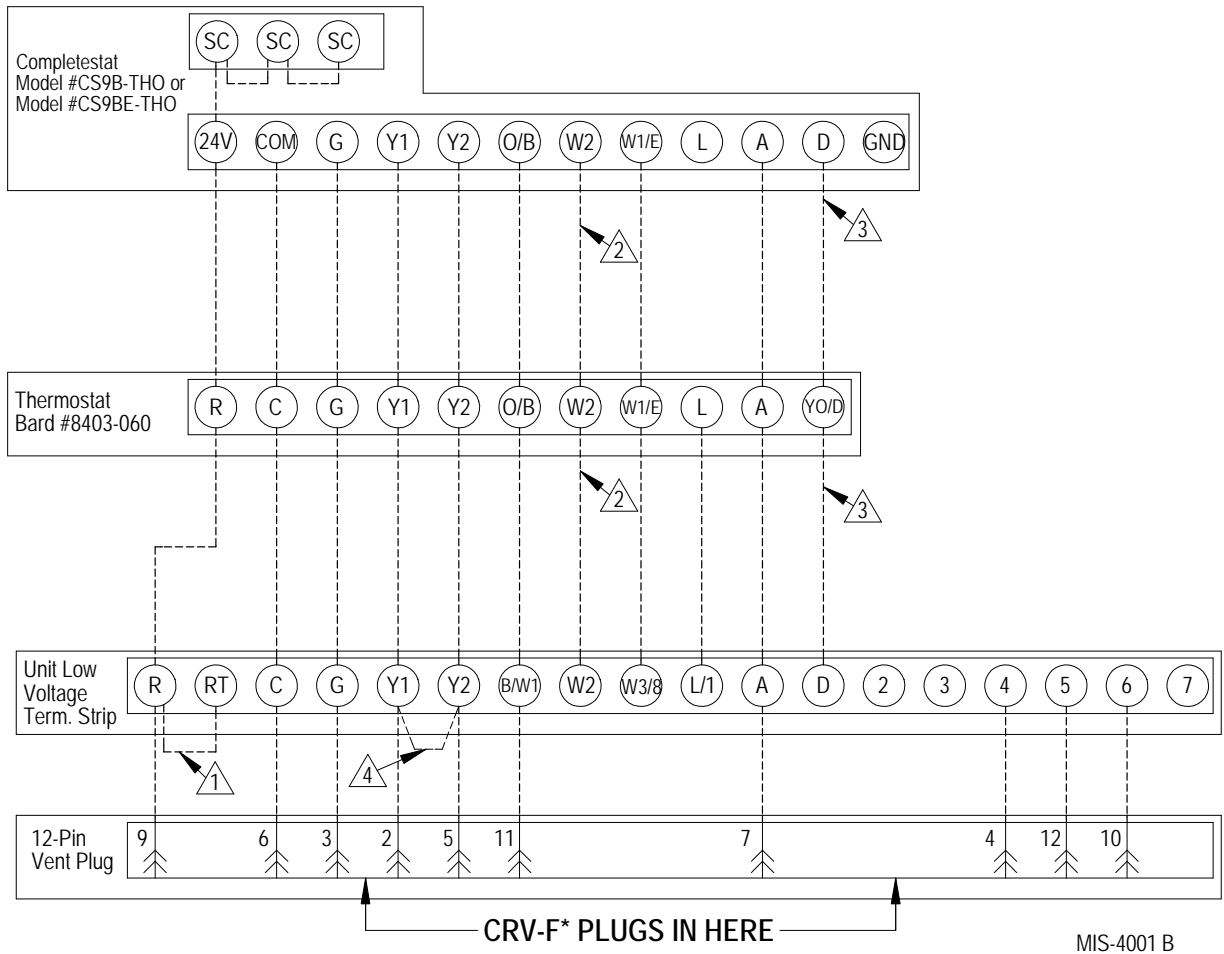

MIS-4001 B

1 Factory installed jumper. Remove jumper and connect to N.C fire alarm circuit if emergency shutdown required.

2 Not needed below 15KW.

3 Additional wire required for dehumidification models.

4 Factory installed jumper. Remove to activate Balanced Climeate™ mode. A 2 stage thermostat is recommended for Balanced Climate mode.

FIGURE 9
Non-Programmable Thermostat Connections for CRV-F* with Air Conditioners

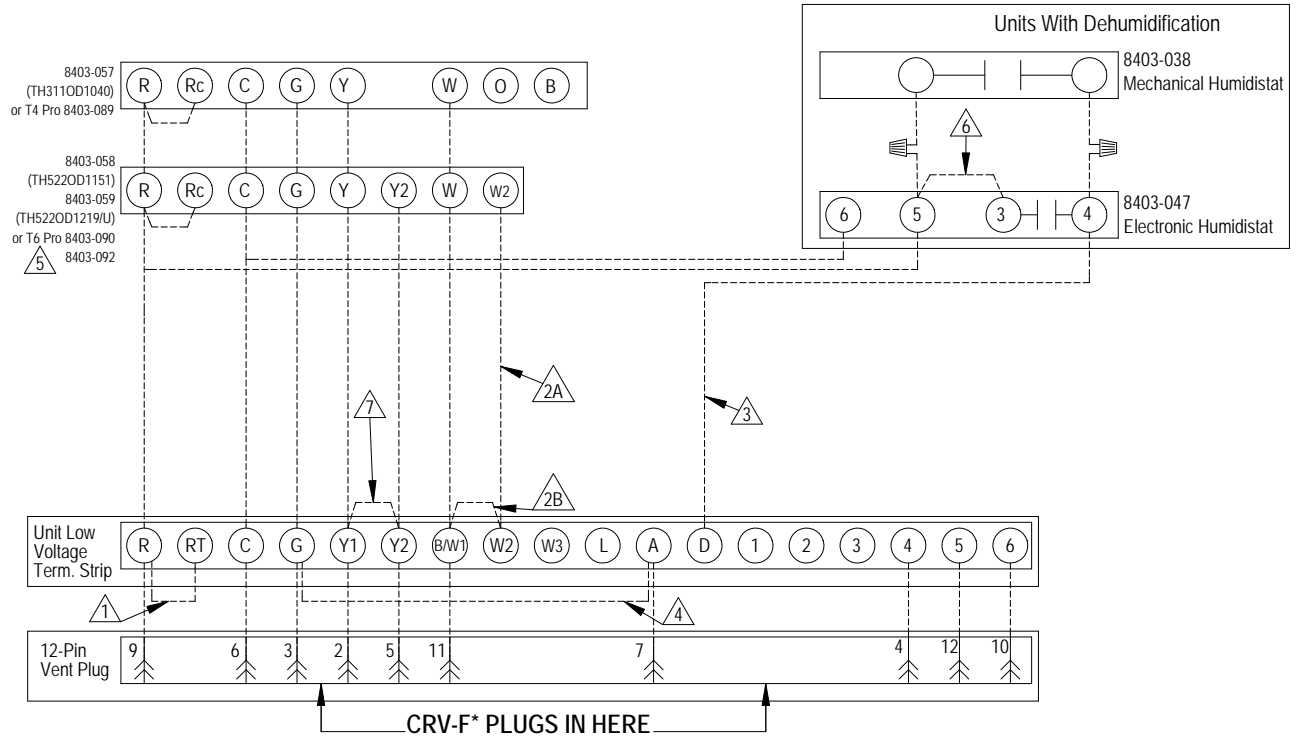

If not equipped with a ventilation option to plug in, a jumper plug must be installed.

- | | |
|--|---|
| <p>⚠ Factory installed jumper. Remove jumper and connect to N.C fire alarm circuit if emergency shutdown required.</p> <p>⚠ Wire not needed below 15KW.</p> <p>⚠ Install Jumper for 1 stage electric heat on units with more than 10KW.</p> <p>⚠ Wire required for dehumidification models only.</p> <p>⚠ Add jumper for vent to operate when blower is energized.</p> | <p>⚠ For 8403-058, change "system type", set up Function 1, From 5 (2 Heat/ 1 Cool heat Pump) to 6 (2 Heat / 2 Cool Conventional). For 8403-059, No change required.</p> <p>⚠ Jumper needs added.</p> <p>⚠ Factory installed jumper. Remove jumper to activate Balanced Climate™ Mode. A 2-stage thermostat is recommended for Balanced Climate mode.</p> |
|--|---|

MIS-4120

FIGURE 10
Non-Programmable Thermostat Connections for CRV-F* with Heat Pumps

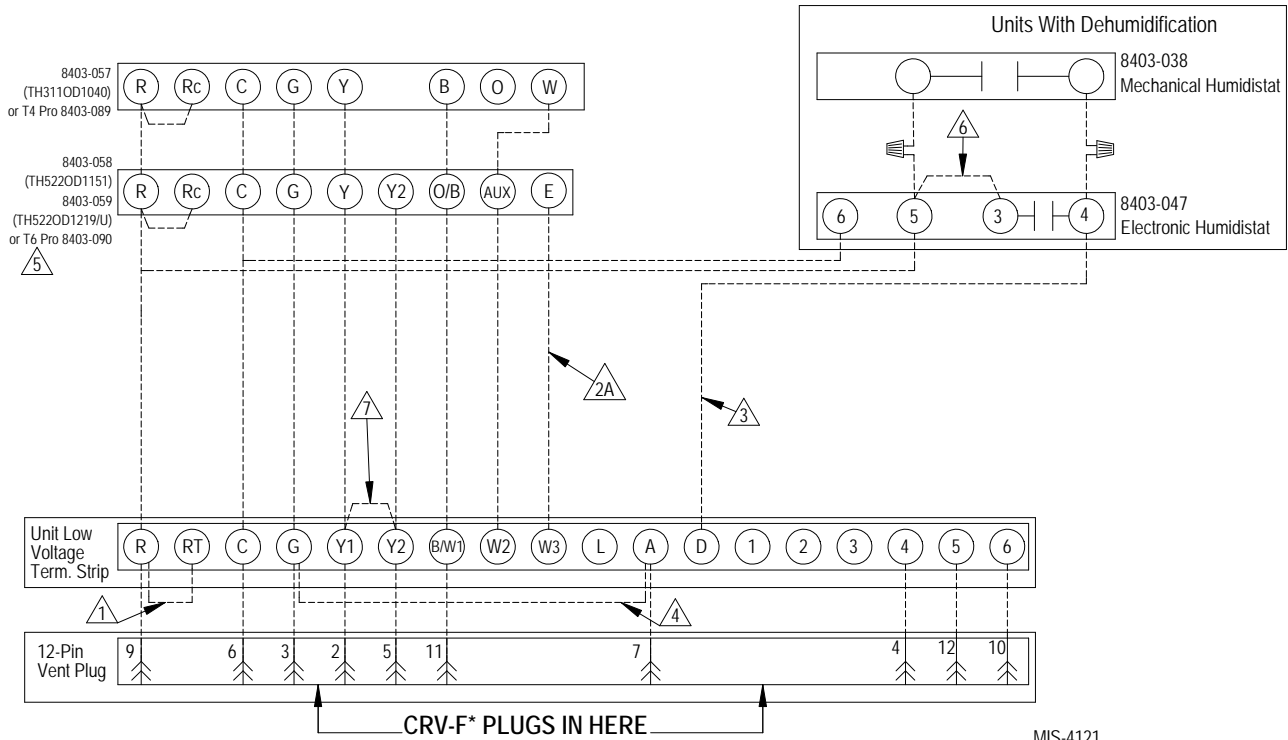

MIS-4121

If not equipped with a ventilation option to plug in, a jumper plug must be installed.

- ⚠️ 1 Factory installed jumper. Remove jumper and connect to N.C fire alarm circuit if emergency shutdown required.
- ⚠️ 2 Wire not needed below 15KW.
- ⚠️ 3 Wire required for dehumidification models only.
- ⚠️ 4 Add jumper for vent to operate when blower is energized.
- ⚠️ 5 For 8403-058, change "system type", set up Function 1, From 5 (2 Heat/ 1 Cool heat Pump) to 6 (2 Heat / 2 Cool Conventional). For 8403-059, No change required.
- ⚠️ 6 Jumper needs added.
- ⚠️ 7 Factory installed jumper. Remove jumper to activate Balanced Climate™ Mode. A 2-stage thermostat is recommended for Balanced Climate mode.

Blade Adjustment for Desired Ventilation Air

The amount of ventilation air supplied by the commercial room ventilator is dependant on four factors.

1. Return air duct static pressure drop.
2. Supply air duct static pressure drop.
3. Indoor blower motor speed.
4. Damper blade open position setting.

Refer to the appropriate graph on the following pages to determine the blade setting needed for required airflow. Adjust blade stop screws accordingly (see Figure 11).

NOTE: Blade setting shipped from factory in #2 position. This will provide 100-150 CFM fresh air.

Balanced Climate™ Mode

Balanced Climate mode can be used for duct free and ducted applications below 0.2" W.C. ESP total static.

If Balanced Climate mode is enabled, blade stop screw positions will need to be adjusted to allow approximately 28% more outdoor air to maintain minimum ventilation requirements.

FIGURE 11
Blade Adjustment for Desired Ventilation Air

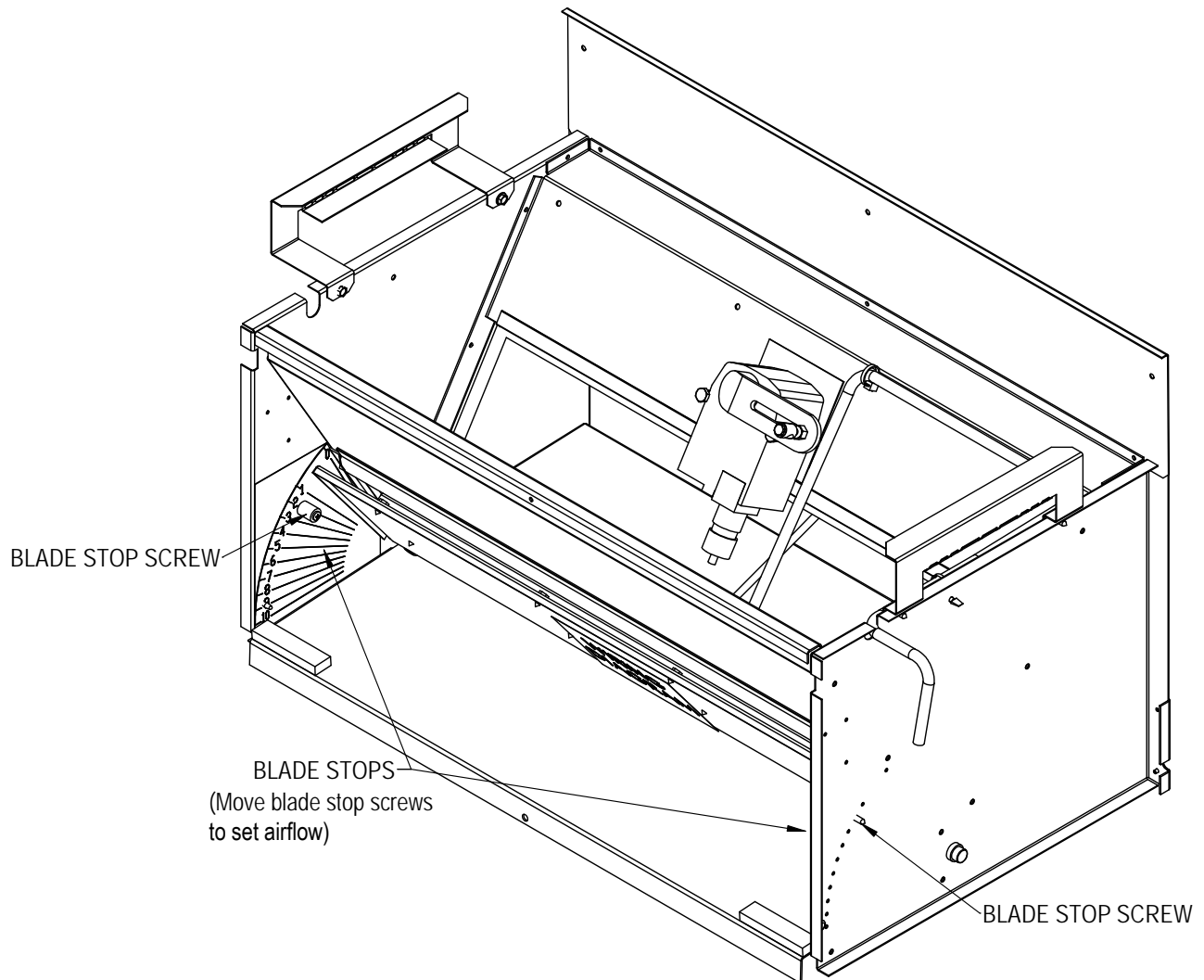

MIS-4002 A

**GRAPH 1
W18 Ventilation Delivery**

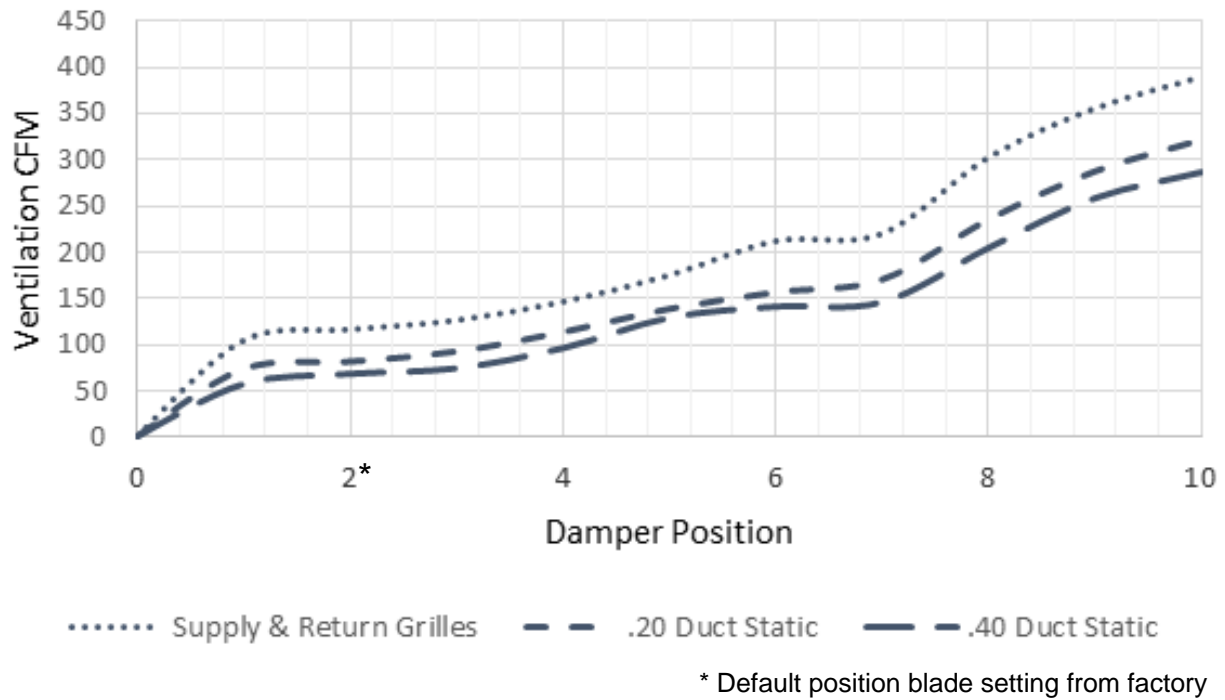

**GRAPH 2
W24 Ventilation Delivery**

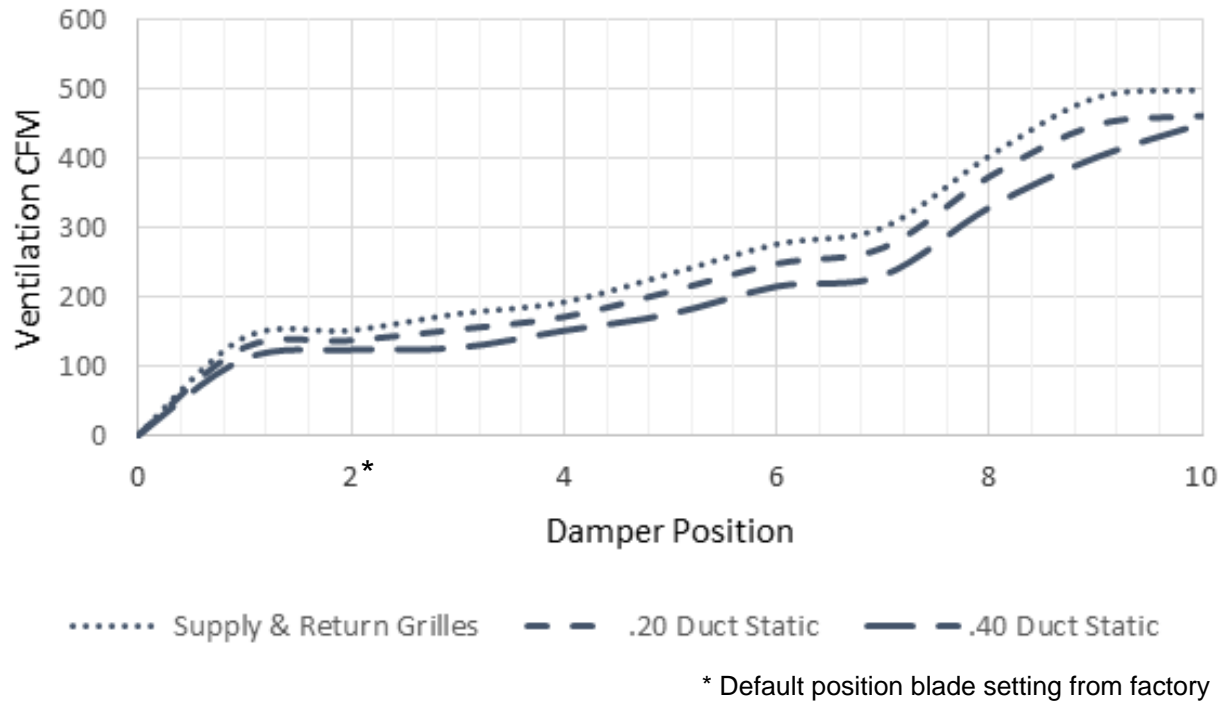

GRAPH 3
W30 Ventilation Delivery



* Default position blade setting from factory

GRAPH 4
W36 Ventilation Delivery

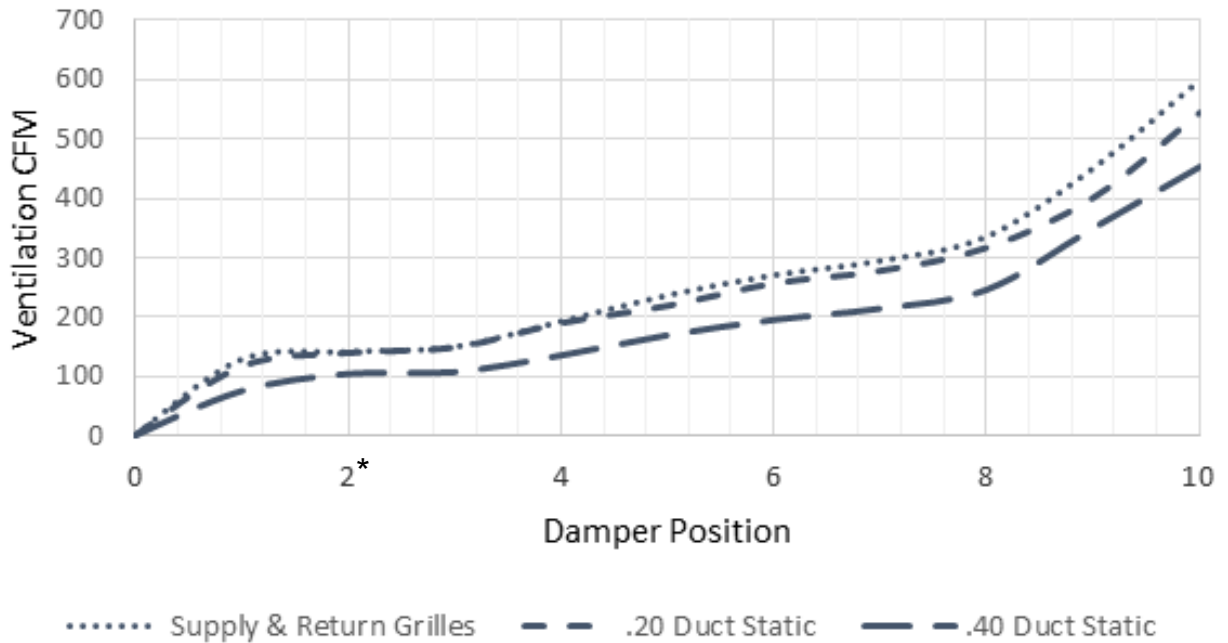

* Default position blade setting from factory

FIGURE 12
Call for Ventilation With or Without Compressor Operation

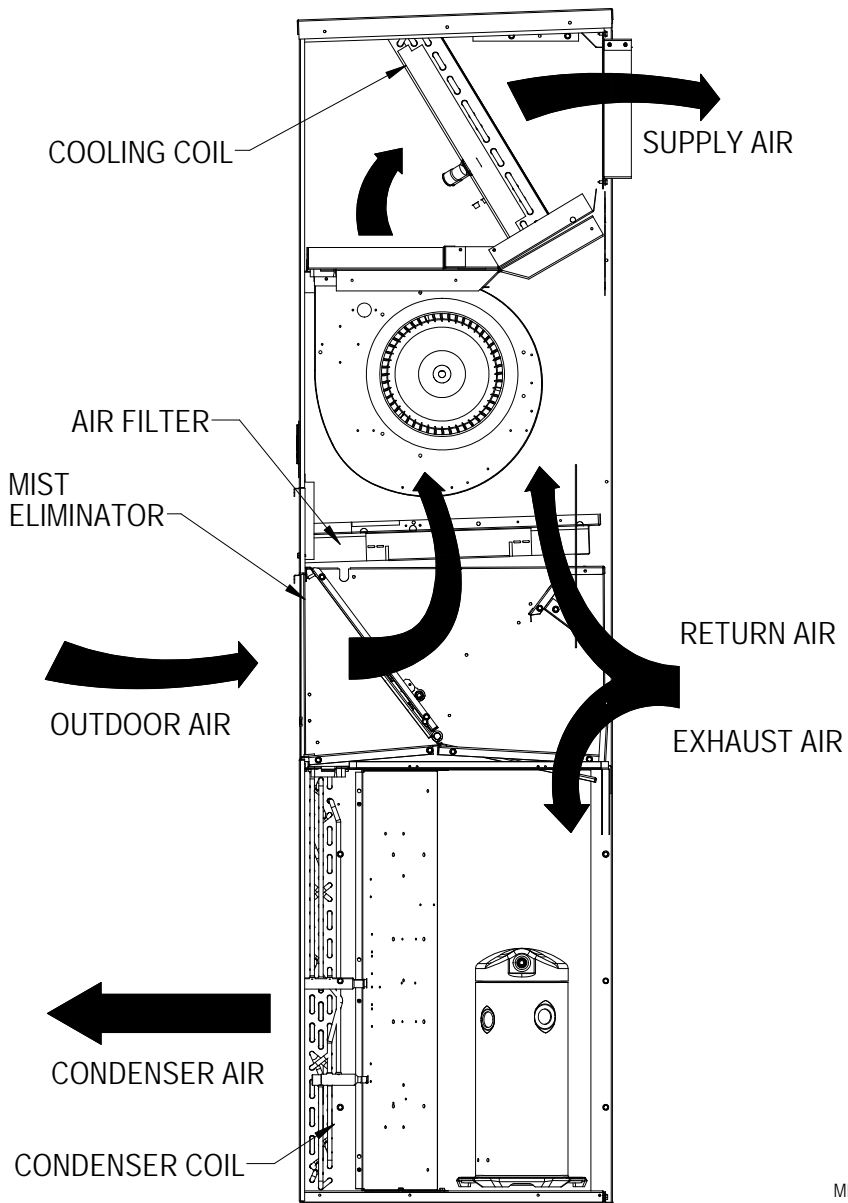

MIS-3866

FIGURE 13
Call for Compressor or Fan Only with Ventilation Off

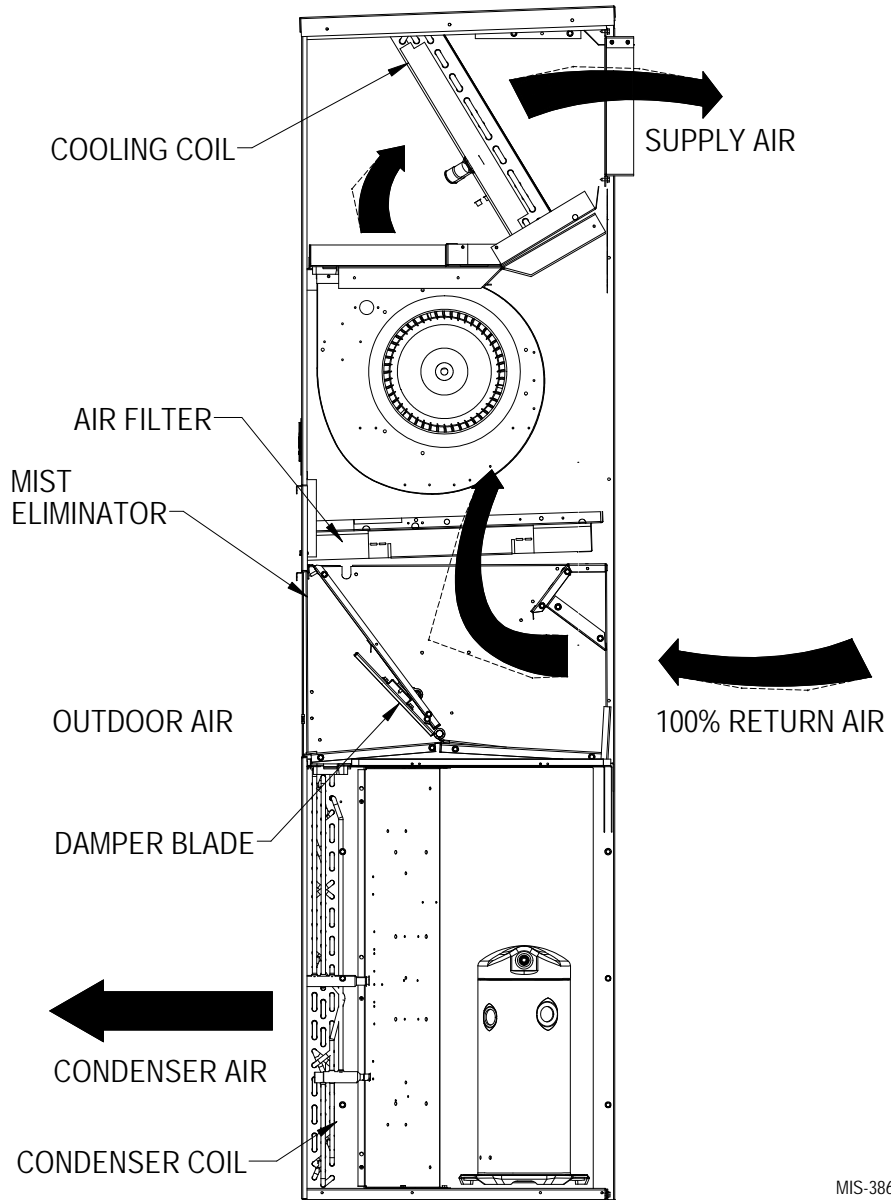

MIS-3867

FIGURE 14
Wiring Diagram

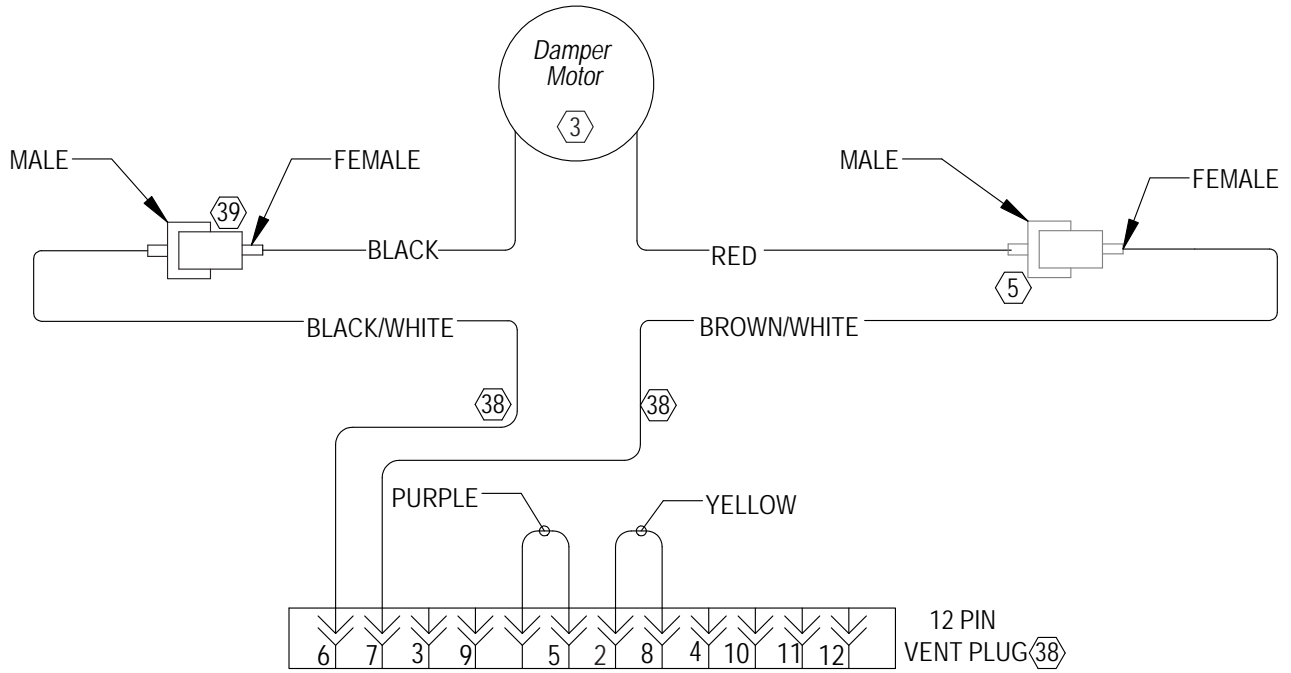

4056-242 B