INSTALLATION INSTRUCTIONS

Partial Flow Commercial Room Ventilator 24 Volt On/Off with Spring Return and Exhaust

Model: CRV-F5



For Use with Bard Single Stage Wall Mount
Air Conditioner and Heat Pump Models:

W42AC, W48AC, W60AC, W72AC
W42HC, W48HC, W60HC



Climate Control Solutions

Bard Manufacturing Company, Inc.
Bryan, Ohio 43506
www.bardhvac.com

Manual: 2100-696A
Supersedes: 2100-696
Date: 9-16-19

CONTENTS

General Information3

Commercial Room Ventilator Model Nomenclature...	3
Unpacking.....	3
General.....	3
Commercial Room Ventilator Features.....	3
Description.....	3
Models.....	3

Installation of Field-Installed CRV-F5.....4

Basic Installation.....	4
Control System Notes.....	8
Blade Adjustment for Desired Ventilation Air.....	8
Sequence of Operation.....	16

Figures

Figure 1	Disconnect Power.....	4
Figure 2	Remove Side Grilles.....	4
Figure 3	Remove Blower Door and Control Panel Cover.....	4
Figure 4	Remove Blank Off Plates (Both Sides)....	5
Figure 5	Remove Exhaust Blank Off Plate.....	5
Figure 6	Install Gasket.....	5
Figure 7	Install Exhaust Blade Assembly.....	5
Figure 8	Remove Air Filters and Low Voltage Control Panel Cover.....	5
Figure 9	Connect 3000-1622 Wire Assembly.....	6
Figure 10	Install Vent.....	6
Figure 11	Control Plug Centered in Plug Access Opening.....	6
Figure 12	Connect CRV Power Plug to Control Panel Plug.....	6
Figure 13	Remove Blade Shipping Screws.....	6
Figure 14	Set Blade Stop to Adjust Fresh Air.....	7
Figure 15	Install Intake Sealing Frame and Lower Block Off Plates.....	7
Figure 16	Install Mist Filters.....	7
Figure 17	Install Bug Screen and Gaskets.....	7
Figure 18	Programmable Thermostat Connections for CRV with Air Conditioners.....	11
Figure 19	Programmable Thermostat Connections for CRV with Heat Pumps.....	12
Figure 20	Non-Programmable Thermostat Connections for CRV with Air Conditioners.....	13
Figure 21	Non-Programmable Thermostat Connections for CRV with Heat Pumps.	14
Figure 22	CRV-F* Wiring Diagram.....	15
Figure 23	Call for Ventilation With or Without Compressor Operation.....	17
Figure 24	Call for Compressor or Fan Only with Ventilation Off.....	17

Graphs

Graph 1	W42AC CRV-F5 Ventilation Delivery.....	9
Graph 2	W48AC CRV-F5 Ventilation Delivery.....	9
Graph 3	W60AC CRV-F5 Ventilation Delivery.....	10
Graph 4	W72AC CRV-F5 Ventilation Delivery.....	10

Table

Table 1	Unit Operation with M Ventilation Option (On/Off CRV).....	16
---------	---	----

Commercial Room Ventilator Model Nomenclature

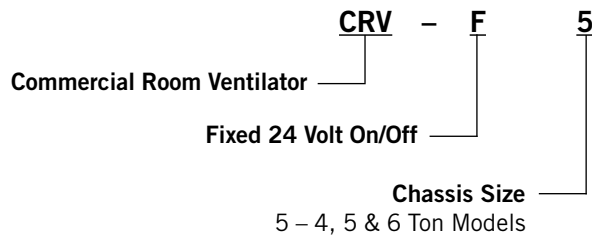

Unpacking

Upon receipt of the equipment be sure to compare the model number found on the shipping label with the accessory identification information on the ordering and shipping document to verify that the correct accessory has been shipped.

Inspect the carton housing of each ventilator as it is received, and before signing the freight bill, verify that all items have been received and that there is no visible damage (check parts list below). Note any shortages or damage on all copies of the freight bill. The receiving party must contact the last carrier immediately, preferably in writing, requesting inspection by the carrier's agent. Concealed damage not discovered until after loading must be reported to the carrier within 15 days of its receipt.

General

The ventilator should only be installed by a trained heating and air conditioning technician. These instructions serve as a guide to the technician installing the ventilator package. They are not intended as a step-by-step procedure with which the mechanically inclined owner can install the package.

The ventilator housing is shipped in one carton which contains the electrical harness, miscellaneous hardware and installation instructions.

Ventilator kit includes:

- (1) CRV-F5 ventilator
- (2) 7003-084 mist filters
- (1) 7003-083 exhaust bug screen
- (2) 539-405 intake sealing frames
- (1) 3000-1622 wire assembly
- (2) 1913-002-0808 8-1/2" foam strips
- (4) 1913-002-0708 7-1/2" foam strips
- (1) 1913-013-2708 foam gasket
- (2) 543-223 lower block off plates
- (12) 1012-086 screws
- (1) 539-414 exhaust damper assembly
- (1) 2100-696A installation instructions

Commercial Room Ventilator Features

- Exhaust air damper – built in with positive closed position. Provides exhaust air capability to prevent pressurization of tight buildings.
- Actuator motor – 24 volt, power open, spring return with built in torque limiting switch.

Description

The CRV-F5 ventilator is designed to be used with the specific models with "letter" revision codes as designated on the front page of this installation instructions manual.

The ventilator is an electromechanical vent system designed to provide fresh air to meet indoor air quality standards.

Models

When installed in the models listed on the front page, the CRV-F5 provides built-in exhaust provisions. When the damper blade opens to bring fresh air in, the damper also opens an exhaust relief. The exhaust air will flow into the condenser section of the unit. The condenser fan will help draw exhaust air out when it is operating with compressor in cooling or heat pump mode.

INSTALLATION OF FIELD-INSTALLED CRV-F5

Basic Installation

WARNING

Electrical shock hazard.
Disconnect remote electrical power supply or supplies before servicing.
Failure to do so could result in electric shock or death.

WARNING

Exposed moving parts.
Disconnect electrical power before servicing.
Failure to do so could result in severe injury or amputation.

CAUTION

Cut hazard.
Wear gloves to avoid contact with sharp edges.
Failure to do so could result in personal injury.

Disconnect all power to unit (see Figure 1).

FIGURE 1
Disconnect Power



Remove both side grilles (see Figure 2).

FIGURE 2
Remove Side Grilles



Remove upper blower door and outer control panel cover (see Figure 3).

FIGURE 3
Remove Blower Door and Control Panel Cover



Remove blank off plates on both sides (behind side grilles) and discard (see Figure 4).

FIGURE 4
Remove Blank Off Plates (Both Sides)



Remove exhaust blank off plate through return or through side intake openings (see Figure 5).

FIGURE 5
Remove Exhaust Blank Off Plate

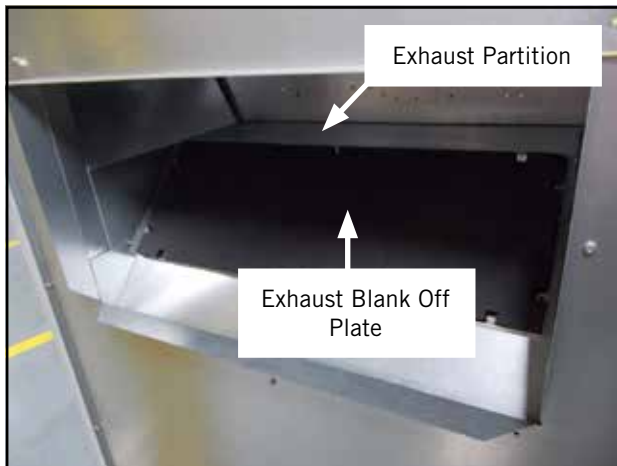

Install 1913-013-2708 gasket 5/8" from bend as shown in Figure 6. Then install exhaust blade assembly using 10 screws (see Figure 7).

FIGURE 6
Install Gasket

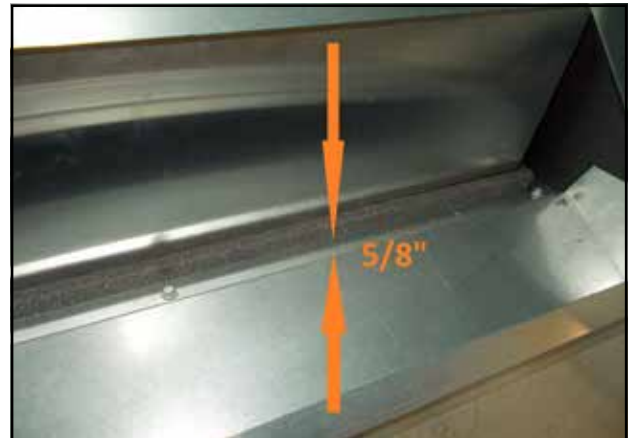
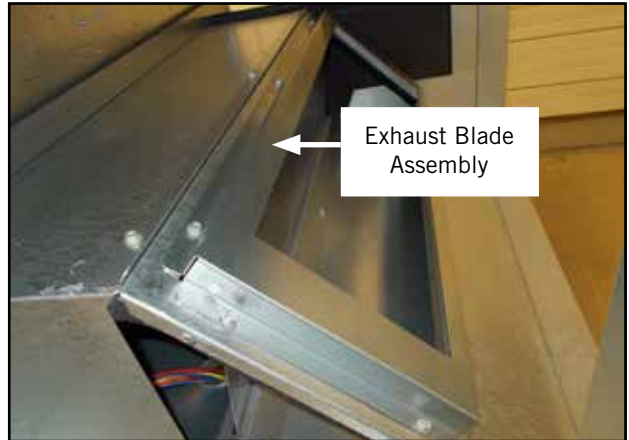
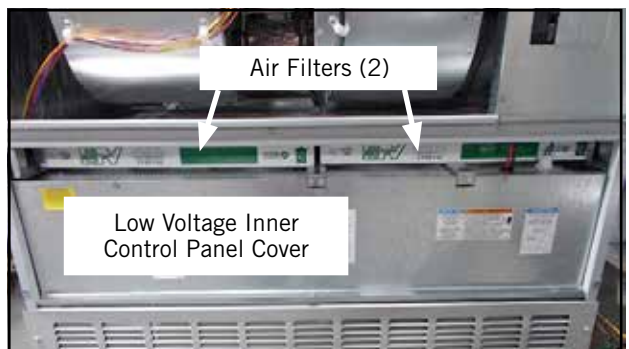

FIGURE 7
Install Exhaust Blade Assembly



Remove both air filters and the low voltage inner control panel cover (see Figure 8).

FIGURE 8
Remove Air Filters and Low Voltage Inner Control Panel Cover



Connect 3000-1622 wire assembly (see Figure 9). Snap the 4 pin connector into the opening next to the low voltage box and plug the 12 pin male connector into the female plug in the low voltage box.

FIGURE 9
Connect 3000-1622 Wire Assembly

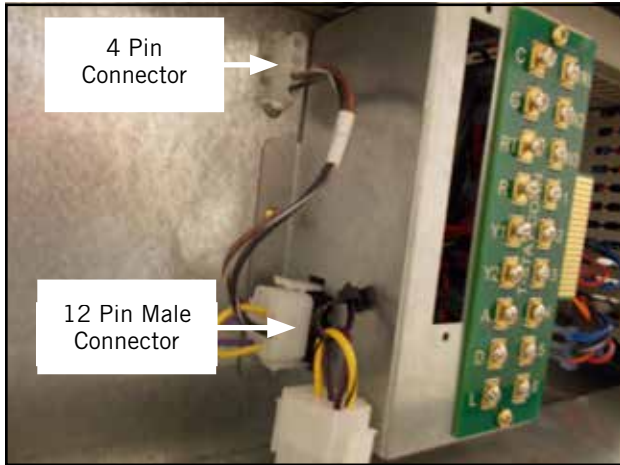

Before installing vent, remove CRV from packaging and verify there is no damage. Install the vent from the side as shown in Figure 10. CRV can be installed from either side.

Set CRV on the exhaust partition (see Figure 5 on page 5) and slide in until flush with the side of the wall mount.

FIGURE 10
Install Vent



When the CRV is fully installed, the control plug should be centered in the plug access opening on the front panel of the CRV as shown in Figure 11.

FIGURE 11
Control Plug Centered in Plug Access Opening

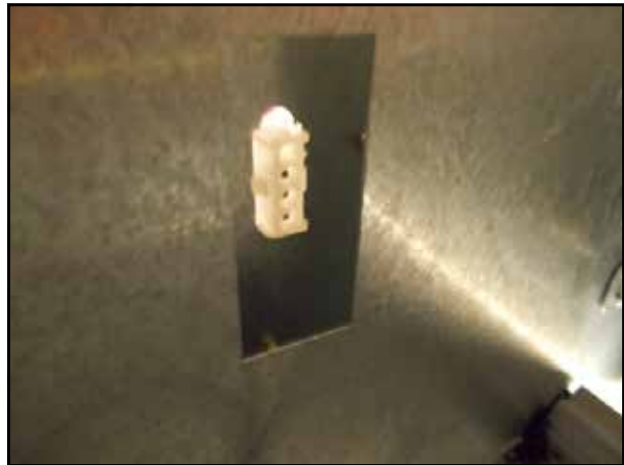

From the front, through the filter opening, plug the CRV power plug into the control panel plug (see Figure 12).

IMPORTANT: Sharp edges--PPE required.

FIGURE 12
Connect CRV Power Plug to Control Panel Plug



The CRV exhaust blade is fixed in the shipping position by two (2) screws, one on each side (see Figure 13). Remove screws to release the blade.

FIGURE 13
Remove Blade Shipping Screws



Set blade stop (see Figure 14) using airflow charts found on pages 9 and 10.

To adjust fresh air amount, loosen set screw two turns on actuator stop. Slide stop to desired setting by putting pressure toward the center drive shaft with screwdriver while moving up and down. Use the marks on the actuator to correlate with the airflow settings as shown.

FIGURE 14
Set Blade Stop to Adjust Fresh Air Amount



Install the 539-405 intake sealing frame and the 543-223 lower block off plates (both sides) as shown in Figure 15. Install two (2) 1913-002-0708 7-1/2" foam gaskets below the intake sealing frame (both sides).

FIGURE 15
Install Intake Sealing Frame and Lower Block Off Plates

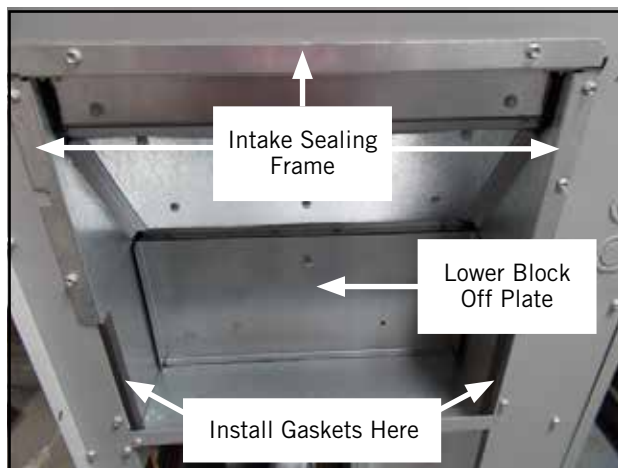

Bend the two (2) sheet metal tabs in the condenser partition up to hold the bottom of the mist eliminator in place.

Install 7003-084 mist filters on both sides (see Figure 16). Then re-install the side grilles removed earlier.

FIGURE 16
Install Mist Filters



Remove the front lower (condenser) grille and bend the two (2) sheet metal tabs in the condenser partition up to hold the bottom of the bug screen in place. Install two (2) 1913-002-0808 8-1/2" foam gaskets to sides of cabinet (see Figure 17). Install the 7003-083 exhaust bug screen. Re-install grille.

FIGURE 17
Install Bug Screen and Gaskets

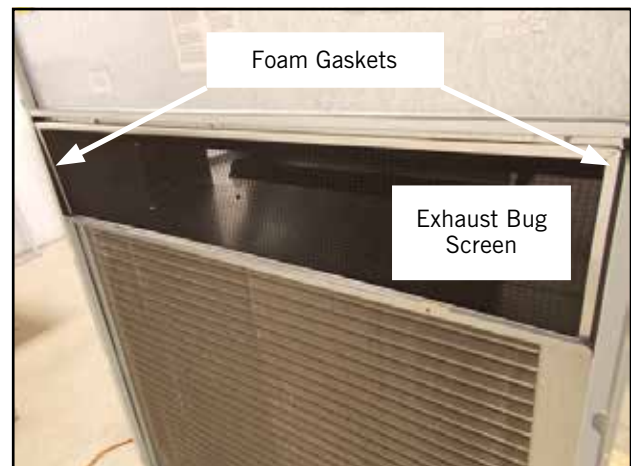

Restore power to unit. The "A" terminal can now be energized to test blade operation. When blade testing is complete, disconnect power.

Install both filters, then re-install the inner control panel cover, outer control panel cover and upper blower door.

Restore power to unit.

Control System Notes

This ventilation package is capable of being set to meet the current ASHRAE specifications for minimum occupied airflow rates.

On/Off Operation

Energizing the A terminal in the low voltage connection box during occupied conditions will drive the fresh air damper to the fixed position selected as shown in Figure 14 on page 7.

Blade Adjustment for Desired Ventilator Air

The amount of ventilation air supplied by the commercial room ventilator is dependant on four factors.

1. Return air duct static pressure drop.
2. Supply air duct static pressure drop.
3. Indoor blower motor speed.
4. Damper blade open position setting.

Refer to the appropriate graph on pages 9 and 10 to determine the blade setting necessary to achieve the ventilation air required.

GRAPH 1
W42AC CRV-F5 Ventilation Delivery

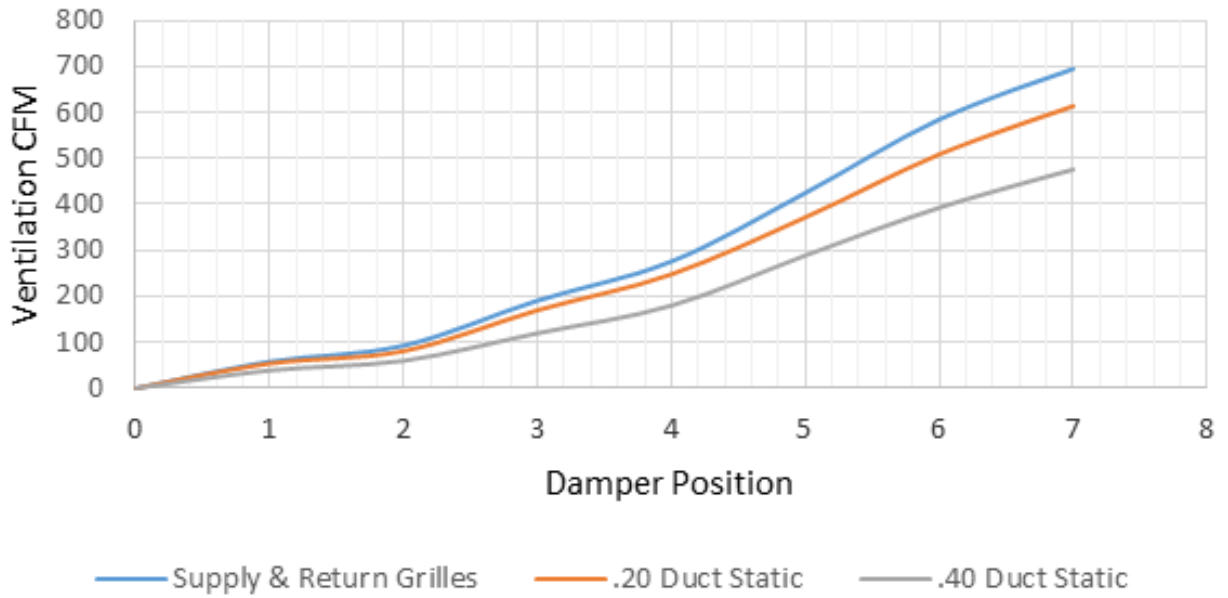

GRAPH 2
W48AC CRV-F5 Ventilation Delivery

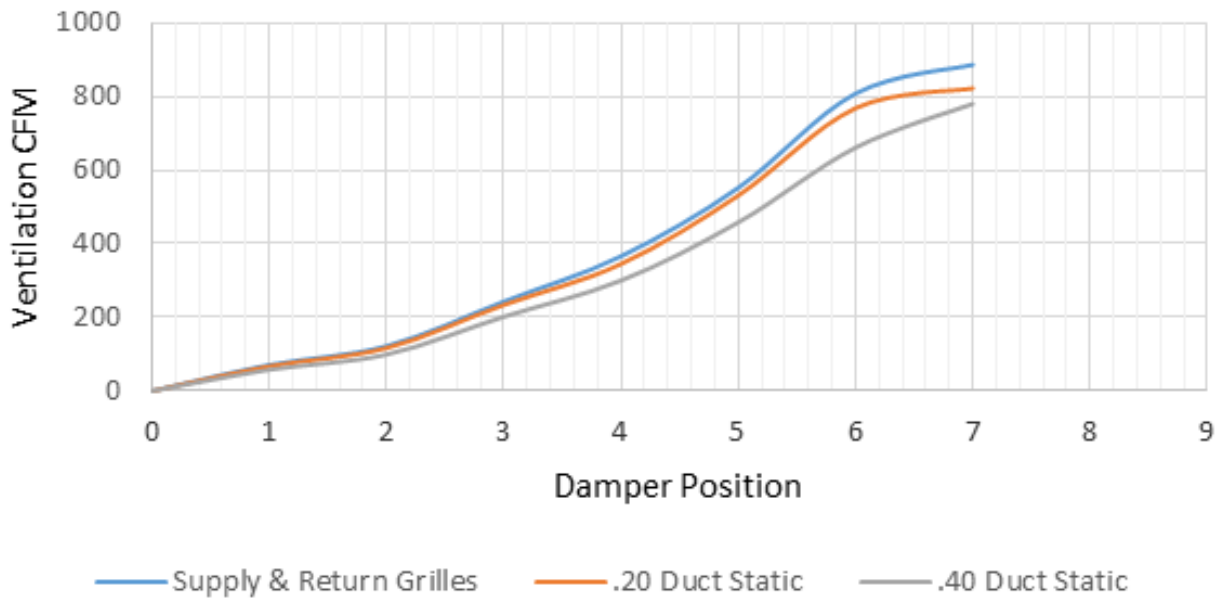

GRAPH 3
W60AC CRV-F5 Ventilation Delivery

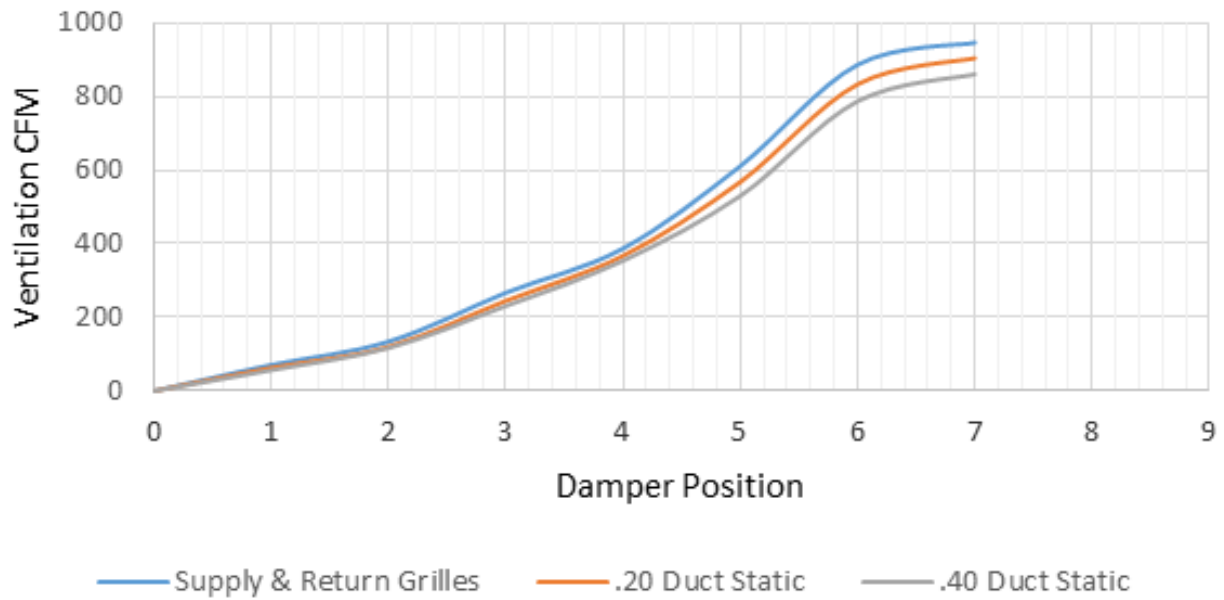

GRAPH 4
W72AC CRV-F5 Ventilation Delivery

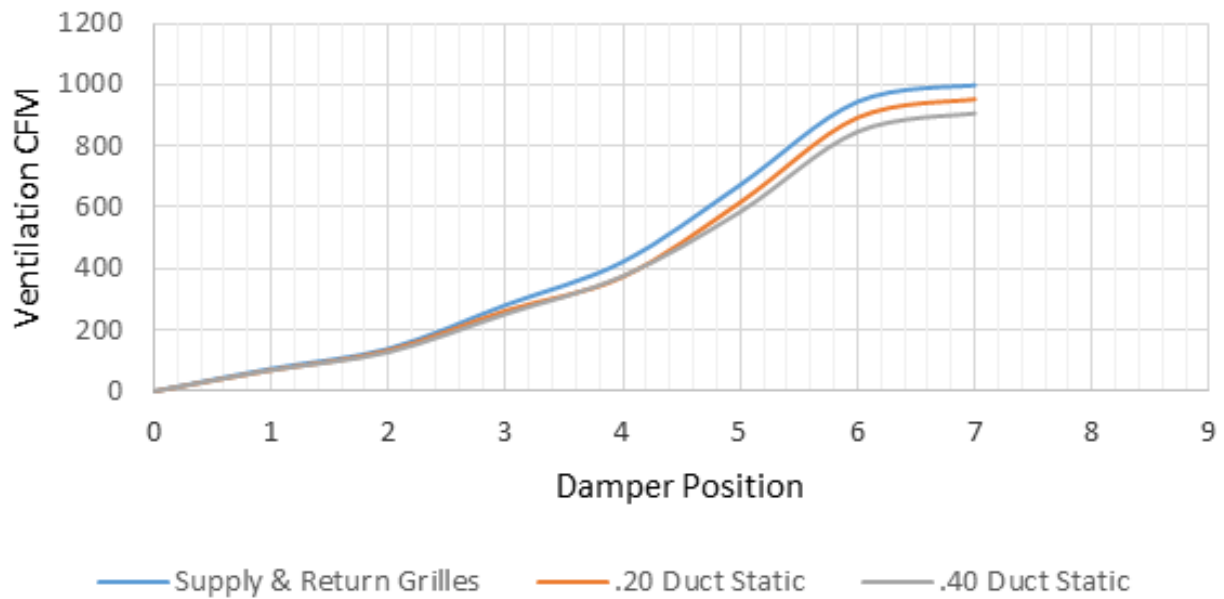
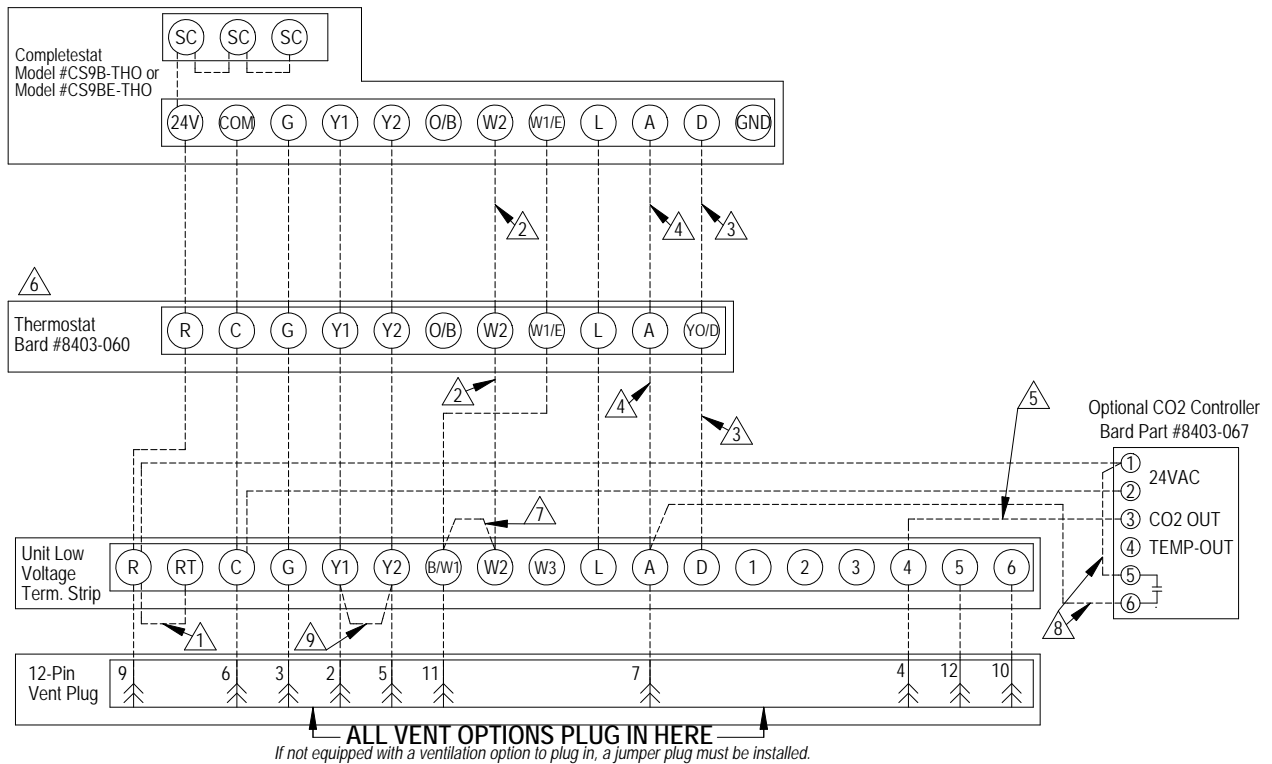

FIGURE 18
Programmable Thermostat Connections for CRV with Air Conditioners



- △1 Factory installed jumper. Remove jumper and connect to N.C fire alarm circuit if emergency shutdown required.
- △2 Wire not needed below 15KW.
- △3 Wire required for dehumidification models only.
- △4 Do not connect "A" from thermostat if optional CO2 controller is used
- △5 0-10 VDC modulating CO2 control signal for modulating ventilation control (optional for ECON only - see vent instruction manuals)

- △6 Change model configuration from heat pump to heat/cool. Must be configured to programmable and fan set to be programmed fan for the "A" output to function during scheduled occupied periods. Must be configured for multi-stage for Y1 output to be active 1st stage cooling. For dehumidification, must be configured for "No Economizer" for YO/D to be active for humidity control.
- △7 Install jumper for 1 stage electric heat on units with less than 15KW
- △8 Do not add these wires if setting up for modulating control. See note 7.
- △9 Factory installed jumper. Remove jumper to activate Balanced Climate™ mode. A 2-stage thermostat is recommended for Balanced Climate mode.

MIS-3974 A

FIGURE 19
Programmable Thermostat Connections for CRV with Heat Pumps

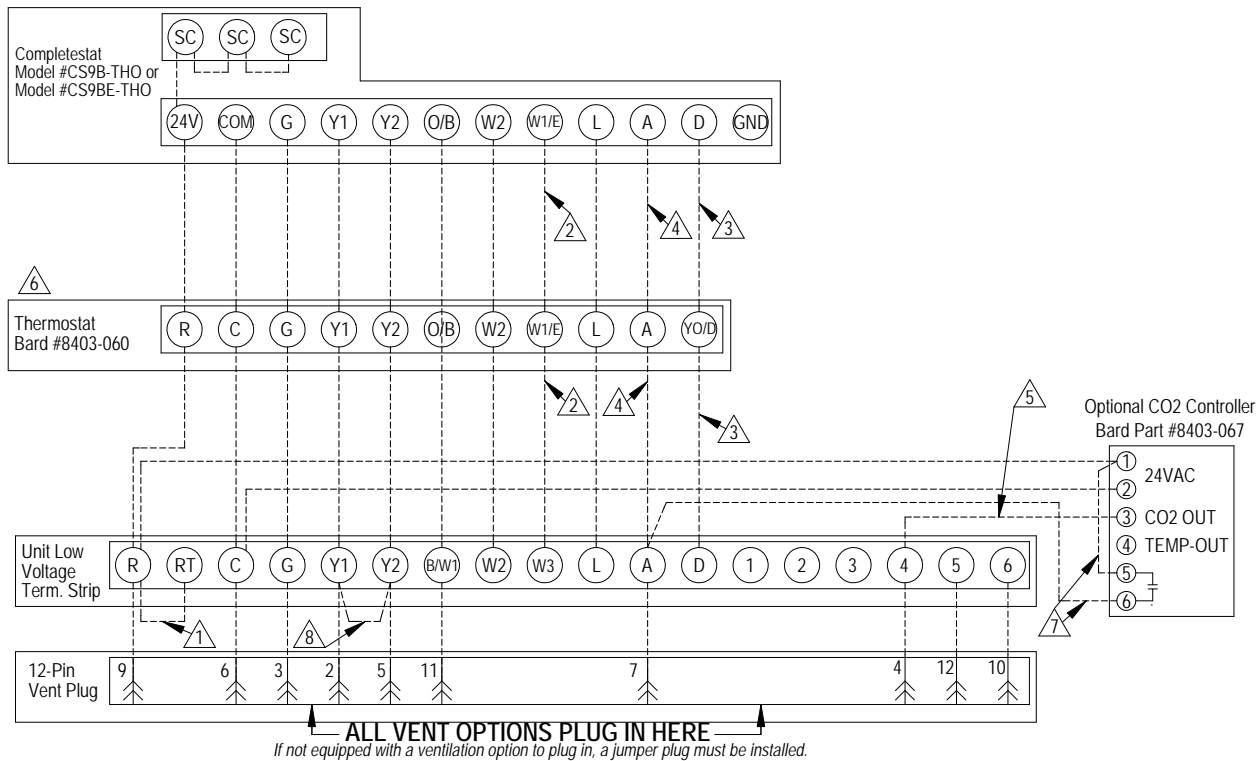

- ① Factory installed jumper. Remove jumper and connect to N.C fire alarm circuit if emergency shutdown required.
- ② Wire not needed below 15KW.
- ③ Wire required for dehumidification models only.
- ④ Do not connect "A" from thermostat if optional CO2 controller is used
- ⑤ 0-10 VDC modulating CO2 control signal for modulating ventilation control (optional for ECON only - see vent instruction manuals)
- ⑥ Ensure model configuration is heat pump and not heat/cool. Must be configured to programmable and fan set to be programmed fan for the "A" output to function during scheduled occupied periods. Must be configured for multi-stage for Y1 output to be active 1st stage cooling. For dehumidification, must be configured for "No Economizer" for YO/D to be active for humidity control.
- ⑦ Do not add these wires if setting up for modulating control.
- ⑧ Factory installed jumper. Remove jumper to activate Balanced Climate™ mode. A 2-stage thermostat is recommended for Balanced Climate mode.

MIS-4063 A

FIGURE 20
Non-Programmable Thermostat Connections for CRV with Air Conditioners

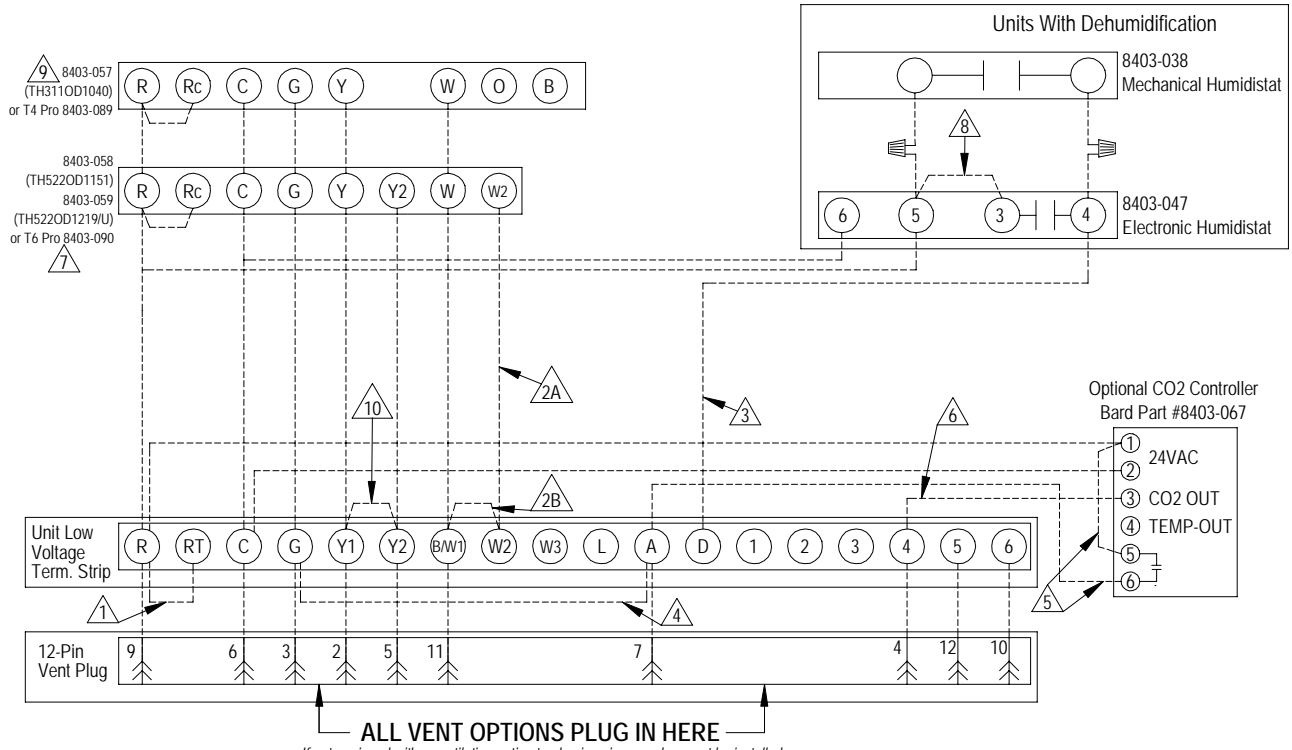

ALL VENT OPTIONS PLUG IN HERE

If not equipped with a ventilation option to plug in, a jumper plug must be installed.

- ⚠ 1 Factory installed jumper. Remove jumper and connect to N.C fire alarm circuit if emergency shutdown required.
- ⚠ 2A Wire not needed below 15KW.
- ⚠ 2B Install Jumper for 1 stage electric heat on units with more than 10KW.
- ⚠ 3 Wire required for dehumidification models only.
- ⚠ 4 For vent operation, add jumper if optional CO2 controller is not used. Vent will run while blower is energized. For ECON & CRV-V an additional wire change is required See install Manual.
- ⚠ 5 Do not add these wires if setting up for modulating control. See note 7.
- ⚠ 6 0-10 VDC Modulating CO2 control signal for modulating ventilation control (Optional for ECON Only) - See vent installation manual.
- ⚠ 7 For 8403-058, change "system type", set up Function 1, From 5 (2 Heat/ 1 Cool heat Pump) to 6 (2 Heat / 2 Cool Conventional). For 8403-059, No change required.
- ⚠ 8 Jumper needs added.
- ⚠ 9 Thermostat will not work with units equipped with economizers.
- ⚠ 10 Factory installed jumper. Remove jumper to activate Balanced Climate™ Mode. A 2-stage thermostat is recommended for Balanced Climate mode.

MIS-3975 A

FIGURE 21
Non-Programmable Thermostat Connections for CRV with Heat Pumps

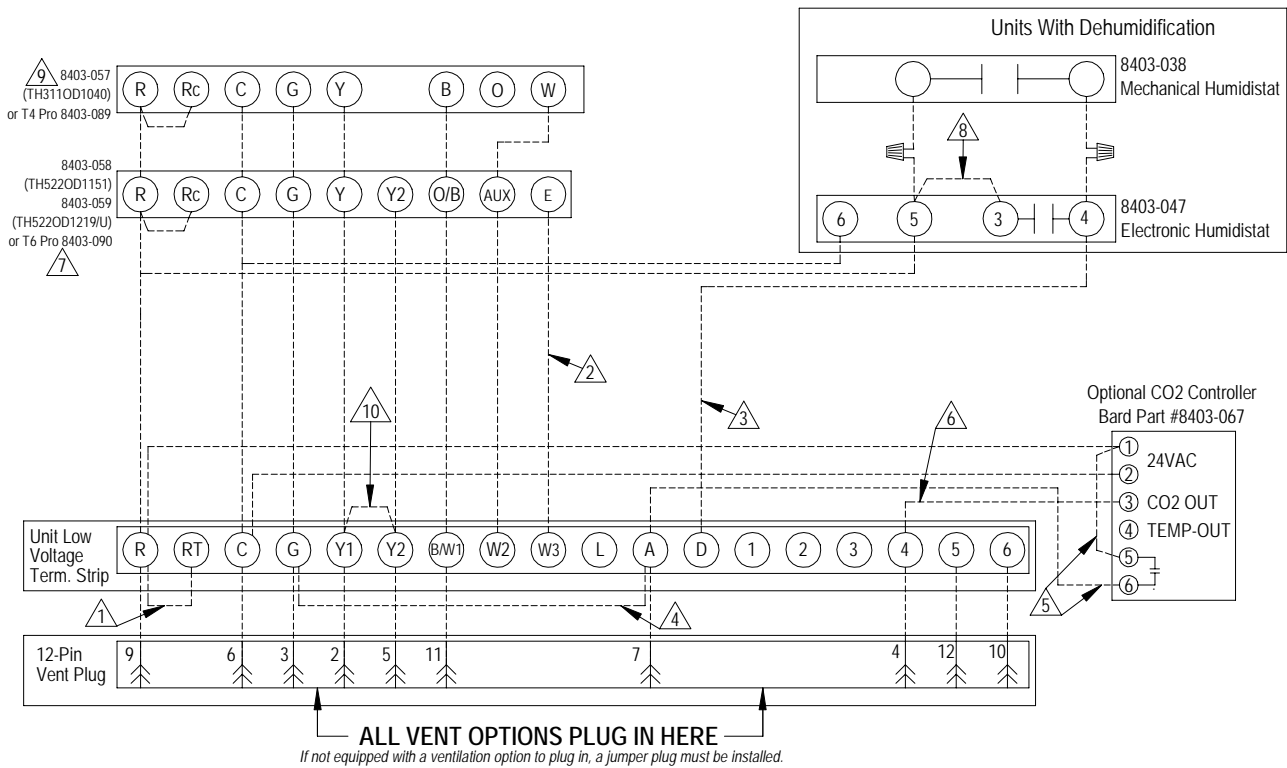

- ⚠ 1 Factory installed jumper. Remove jumper and connect to N.C fire alarm circuit if emergency shutdown required.
- ⚠ 2 Wire not needed below 15KW.
- ⚠ 3 Wire required for dehumidification models only.
- ⚠ 4 For vent operation, add jumper if optional CO2 controller is not used. Vent will run while blower is energized. For ECON & CRV-V, an additional wire change is required. See install manual.
- ⚠ 5 Do not add these wires if setting up for modulating control. See note 6.
- ⚠ 6 0-10 VDC Modulating CO2 control signal for modulating ventilation control (Optional for ECON Only) - See vent installation manual.
- ⚠ 7 For 8403-058, change "system type", set up Function 1, From 5 (2 Heat/ 1 Cool heat Pump) to 6 (2 Heat / 2 Cool Conventional). For 8403-059, No change required.
- ⚠ 8 Jumper needs added.
- ⚠ 9 Thermostat will not work with units equipped with economizers.
- ⚠ 10 Factory installed jumper. Remove jumper to activate Balanced Climate™ Mode. A 2-stage thermostat is recommended for Balanced Climate mode.

MIS-4064 A

FIGURE 22
CRV-F* Wiring Diagram

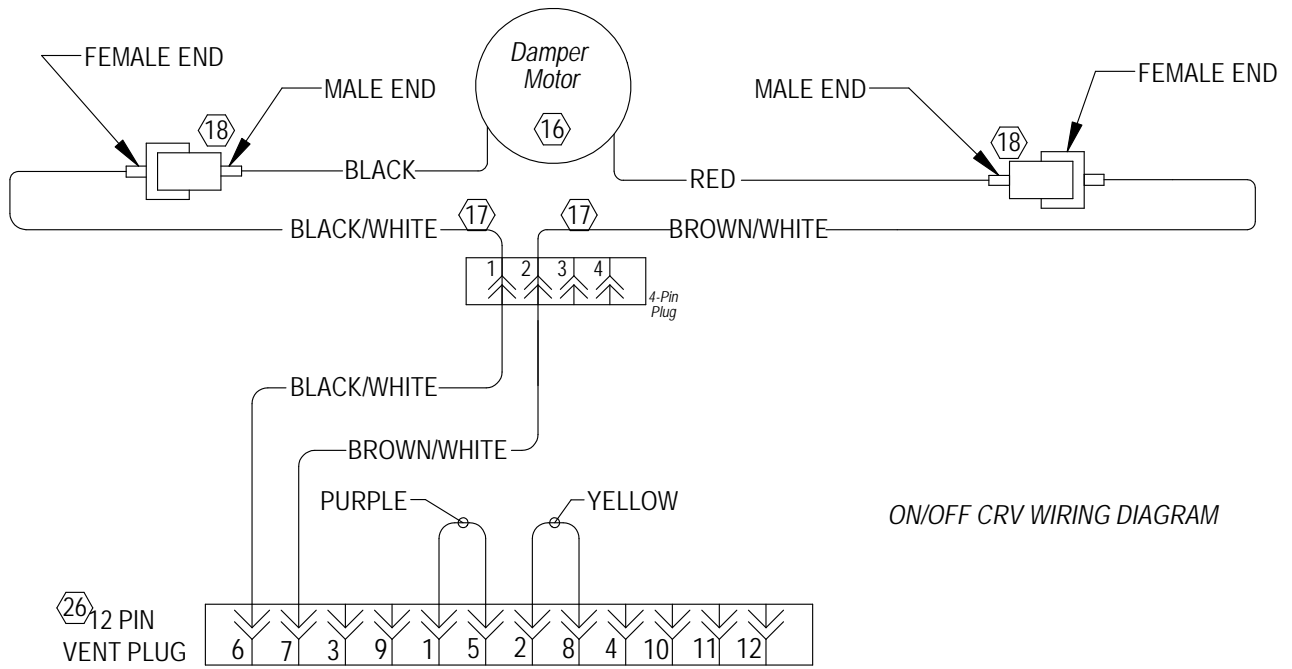

4056-244

Sequence of Operation

On/Off ventilation options energize when the “A” low voltage strip terminal is energized signaling occupancy, and de-energize when “A” terminal is no longer receiving a 24VAC signal. The “G” low voltage strip terminal is used to operate the indoor blower for unit airflow.

The M On/Off CRV vent option is a damper blade operated by a 24VAC motor that when energized opens to a pre-adjusted setting. The airflow amount being brought in will be dependent on the blower speed during unit operation.

TABLE 1
Unit Operation with M Ventilation Option (On/Off CRV)

Unit Operation	Occ. Signal	Low Voltage 24VAC							Speed Taps			Fan Speed	Comp. Oper.	Damper
		G	Y1	Y2	W1	W2	A	D	1	2	3-4-5 ¹			
Fan Only	Yes	X					X		X			Vent	Off	Open
Fan Only	No	X							X			Vent	Off	Closed
BC Cooling	Yes		X				X		X	X		B Climate	On	Open
BC Cooling	No		X						X	X		B Climate	On	Closed
Full Load Cool	Yes		X	X			X		X	X	X	Lo/Med/Hi	On	Open
Full Load Cool	No		X	X					X	X	X	Lo/Med/Hi	On	Closed
1st Stage Heat	Yes				X		X				X	Lo/Med/Hi	Off	Open
1st Stage Heat	No				X						X	Lo/Med/Hi	Off	Closed
2nd Stage Heat	Yes				X	X	X				X	Lo/Med/Hi	Off	Open
2nd Stage Heat	No				X	X					X	Lo/Med/Hi	Off	Closed
Dehumidify ²	Yes						X	X	X	X		B Climate	On	Open
Dehumidify ²	No						X	X	X			B Climate	On	Closed

BC and B Climate – Balanced Climate

¹ Fan speed is selectable through the blower speed control terminal block. LO (default), MED or HI speeds can be used.

² Dehumidification operation is disabled when a call for heating or cooling occurs. Unit runs at Balanced Climate speed during dehumidification operation.

FIGURE 23
Call for Ventilation With or Without Compressor Operation

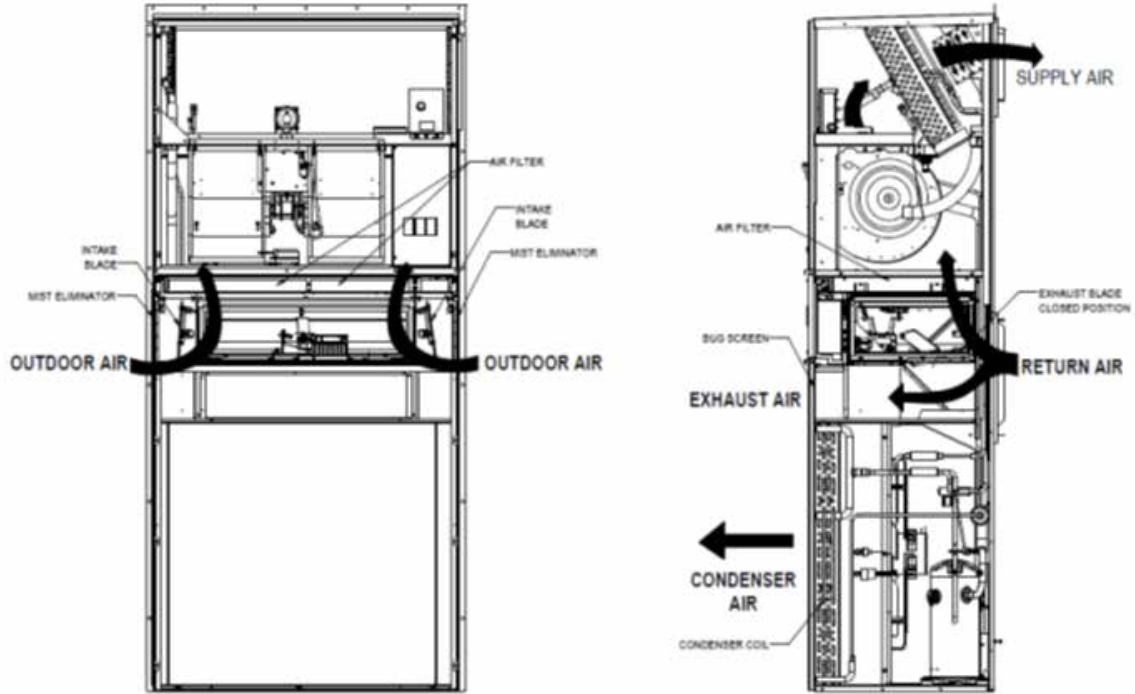

MIG-4036

FIGURE 24
Call for Compressor or Fan Only with Ventilation Off

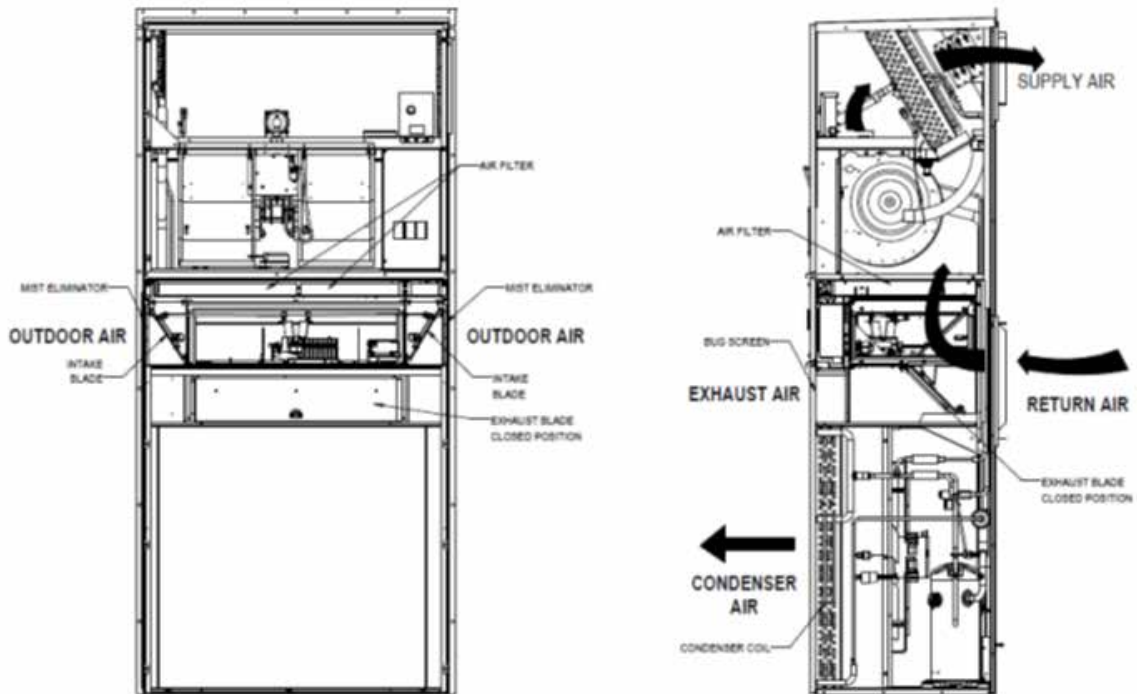

MIG-4037